

# DELIVERY SPECIFICATION

SPEC. No. C-LowT-b

D A T E : Aug,2019

To

**Non-Controlled Copy**

CUSTOMER'S PRODUCT NAME

TDK PRODUCT NAME

Multilayer Ceramic Chip Capacitors (Low Profile)  
 Bulk and Tape Packaging 【RoHS compliant】  
 CGB1,CGB2,CGB3,CGB4 Type  
 X5R,X6S,X7R,X7S,B Characteristics

Please return this specification to TDK representatives with your signature.  
 If orders are placed without returned specification, please allow us to judge that specification is accepted by your side.

## RECEIPT CONFIRMATION

DATE:                      YEAR                      MONTH                      DAY

TDK Corporation  
 Sales  
 Electronic Components  
 Sales & Marketing Group

Engineering  
 Electronic Components Business Company  
 Ceramic Capacitors Business Group

APPROVED	Person in charge

APPROVED	CHECKED	Person in charge

## ■ CATALOG NUMBER CONSTRUCTION

<b>CGB</b>	<b>3</b>	<b>S</b>	<b>1</b>	<b>X5R</b>	<b>0J</b>	<b>106</b>	<b>M</b>	<b>050</b>	<b>A</b>	<b>C</b>
(1)	(2)	(3)	(4)	(5)	(6)	(7)	(8)	(9)	(10)	(11)

### (1) Series

### (2) Dimensions L x W (mm)

Code	EIA	Length	Width	Terminal width
1	CC0201	0.60	0.30	0.10 min.
2	CC0402	1.00	0.50	0.10 min.
3	CC0603	1.60	0.80	0.20min.
4	CC0805	2.00	1.25	0.20min.

### (3) Thickness code

Code	Thickness
T	0.22 mm max.
A	0.33 mm max.
S	0.50 mm max.
B	0.55 mm max.
C	0.65 mm max.

### (4) Voltage condition for life test

Symbol	Condition
1	1 × R.V.
3	1.5 × R.V.

### (5) Temperature characteristics

Temperature characteristics	Capacitance change	Temperature range
JB	±10%	-25 to +85°C
X5R	±15%	-55 to +85°C
X6S	±22%	-55 to +105°C
X7R	±15%	-55 to +125°C
X7S	±22%	-55 to +125°C

### (6) Rated voltage (DC)

Code	Voltage (DC)
0G	4.0V
0J	6.3V
1A	10V
1C	16V
1E	25V

### (7) Nominal capacitance (pF)

The capacitance is expressed in three digit codes and in units of pico Farads (pF). The first and second digits identify the first and second significant figures of the capacitance. The third digit identifies the multiplier. R designates a decimal point.

(Example)0R5 = 0.5pF  
 101 = 100pF  
 225 = 2,200,000pF = 2.2μF

### (8) Capacitance tolerance

Code	Tolerance
K	±10%
M	±20%

### (9) Thickness

Code	Thickness
022	0.22 mm max.
033	0.33 mm max.
050	0.50 mm max.
055	0.55 mm max.
065	0.65 mm max.

### (10) Packaging style

Code	Style
A	178mm reel, 4mm pitch
B	178mm reel, 2mm pitch

### (11) Special reserved code

Code	Description
B,C	TDK internal code

**SCOPE**

This delivery specification shall be applied to Multilayer ceramic chip capacitors to be delivered to \_\_\_\_\_.

**PRODUCTION PLACES**

Production places defined in this specification shall be TDK Corporation, TDK(Suzhou)Co.,Ltd and TDK Components U.S.A.,Inc.

**PRODUCT NAME**

The name of the product to be defined in this specifications shall be CGB◇◇◇○○○△△□□□ x.

**REFERENCE STANDARD**

- JIS C 5101 – 1 : 2010 Fixed capacitors for use in electronic equipment-Part 1: Generic specification  
 C 5101 – 22 : 2014 Fixed capacitors for use in electronic equipment-Part 22 : Sectional specification  
 : Fixed surface mount multilayer capacitors of ceramic dielectric,Class2  
 C 0806 – 3 : 2014 Packaging of components for automatic handling - Part 3: Packaging of surface mount components on continuous tapes  
 JEITA RCR – 2335 C 2014 Safety application guide for fixed ceramic capacitors for use in electronic equipment

**CONTENTS**

1. CODE CONSTRUCTION
2. COMBINATION OF RATED CAPACITANCE AND TOLERANCE
3. OPERATING TEMPERATURE RANGE
4. STORING CONDITION AND TERM
5. INDUSTRIAL WASTE DISPOSAL
6. PERFORMANCE
7. INSIDE STRUCTURE AND MATERIAL
8. PACKAGING
9. SOLDERING CONDITION
10. CAUTION
11. TAPE PACKAGING SPECIFICATION

**<EXPLANATORY NOTE>**

When the mistrust in the spec arises, this specification is given priority. And it will be confirmed by written spec change after conference of both posts involved.

This specification warrants the quality of the ceramic chip capacitor. Capacitors should be evaluated or confirmed a state of mounted on your product.

If the use of the capacitors goes beyond the bounds of this specification, we can not afford to guarantee.

Division	Date	SPEC. No.
Ceramic Capacitors Business Group	Aug, 2019	C-LowT-b

### 1. CODE CONSTRUCTION

(Example) CGB 2 A 3 X5R 0J 105 K T OOOO  
 (1) (2) (3) (4) (5) (6) (7) (8) (9) (10)

(1) Series

Symbol	Series
CGB	Low Profile

(2) Case size

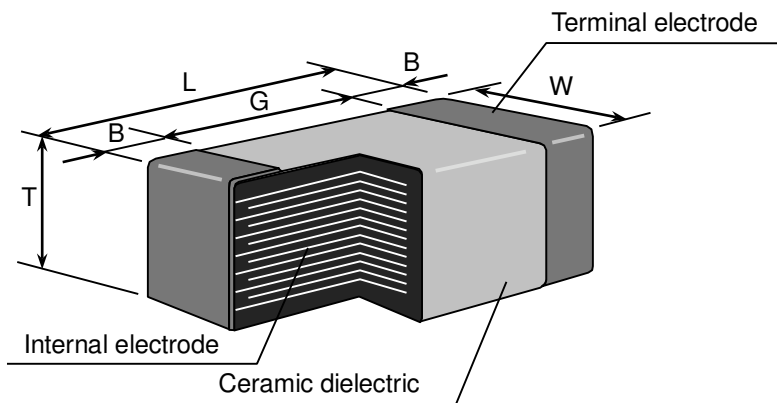

Case size Symbol	Case size [EIA style]	Dimensions (Unit : mm)				
		L	W	T	B	G
1	CGB1 [CC0201]	0.60±0.03	0.30±0.03	0.19±0.03	0.10 min.	0.20 min.
2	CGB2 [CC0402]	1.00±0.05	0.50±0.05	0.19±0.03	0.10 min.	0.30 min.
				0.30±0.03		
		1.00±0.10	0.50±0.10	0.30±0.03		
		1.00±0.15	0.50±0.15	0.30±0.03		
3	CGB3 [CC0603]	1.60±0.10	0.80±0.10	0.50±0.05	0.20 min.	0.30 min.
				0.45±0.05		
		1.60+0.20/-0.10	0.80+0.20/-0.10	0.60±0.05		
4	CGB4 [CC0805]	2.00±0.20	1.25±0.20	0.50±0.05	0.20 min.	0.50 min.

\* As for each item, please refer to detail page on TDK Web.

(3) Thickness

Symbol	Thickness
T	0.22 mm max.
A	0.33 mm max.
S	0.50 mm max.
B	0.55 mm max.
C	0.65 mm max.

(4) Voltage condition in the life test

\* Details are shown in table1 No.15 at 6.PERFORMANCE

Symbol	Condition
1	Rated Voltage
3	Rated Voltage x 1.5

## (5) Temperature Characteristics

\* Details are shown in table1 No.6 at 6.PERFORMANCE

## (6) Rated Voltage

Symbol	Rated Voltage
1 E	DC 25 V
1 C	DC 16 V
1 A	DC 10 V
0 J	DC 6.3 V
0 G	DC 4 V

## (7) Rated Capacitance

Stated in three digits and in units of pico farads (pF).  
The first and Second digits identify the first and second significant figures of the capacitance, the third digit identifies the multiplier.

(Example)

Symbol	Rated Capacitance
105	1,000,000 pF

## (8) Capacitance tolerance

Symbol	Tolerance
K	± 10 %
M	± 20 %

## (9) Packaging

\* CGB1,CGB2 type is applicable to tape packaging only.

Symbol	Packaging
B	Bulk
T	Taping

## (10) TDK internal code

## 2. COMBINATION OF RATED CAPACITANCE AND TOLERANCE

Temperature Characteristics	Capacitance tolerance	Rated capacitance
X5R X6S X7R X7S B	K ( $\pm 10\%$ ) M ( $\pm 20\%$ )	E- 3 series

Capacitance Step in E series

E series	Capacitance Step		
E- 3	1.0	2.2	4.7

## 3. OPERATING TEMPERATURE RANGE

Temperature Characteristics	Min. operating Temperature	Max. operating Temperature	Reference Temperature
B	-25°C	85°C	20°C
X5R	-55°C	85°C	25°C
X6S	-55°C	105°C	25°C
X7R/X7S	-55°C	125°C	25°C

## 4. STORING CONDITION AND TERM

Storing temperature	Storing humidity	Storing term
5~40°C	20~70%RH	Within 6 months upon receipt.

## 5. INDUSTRIAL WASTE DISPOSAL

Dispose this product as industrial waste in accordance with the Industrial Waste Law.

## 6. PERFORMANCE

table 1

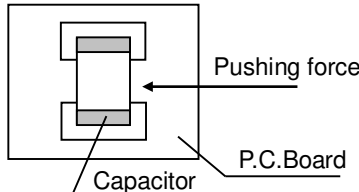
No.	Item	Performance	Test or inspection method																				
1	External Appearance	No defects which may affect performance.	Inspect with magnifying glass (3×), in case of CGB1[CC0201] type, with magnifying glass (10×)																				
2	Insulation Resistance	Please refer to detail page on TDK Web.	Measuring voltage : Rated voltage Voltage application time : 60s.																				
3	Voltage Proof	Withstand test voltage without insulation breakdown or other damage.	Applied voltage : 2.5 times of rated voltage Voltage application time : 1s. Charge / discharge current : 50mA or lower																				
4	Capacitance	Within the specified tolerance.	Please refer to the TABLE A in the end of the specification.																				
5	Dissipation Factor	Please refer to detail page on TDK Web.	See No.4 in this table for measuring condition.																				
6	Temperature Characteristics of Capacitance	<table border="1"> <thead> <tr> <th colspan="2">Capacitance Change(%)</th> </tr> <tr> <th>No voltage applied</th> <th>With voltage Applied</th> </tr> </thead> <tbody> <tr> <td>X5R: ±15</td> <td rowspan="5">Please contact with our sales representative.</td> </tr> <tr> <td>X6S: ±22</td> </tr> <tr> <td>X7R: ±15</td> </tr> <tr> <td>X7S: ±22</td> </tr> <tr> <td>B : ±10</td> </tr> </tbody> </table>	Capacitance Change(%)		No voltage applied	With voltage Applied	X5R: ±15	Please contact with our sales representative.	X6S: ±22	X7R: ±15	X7S: ±22	B : ±10	<p>Capacitance shall be measured by the steps shown in the following table, after thermal equilibrium is obtained for each step.  <math>\Delta C</math> be calculated ref. STEP3 reading.</p> <table border="1"> <thead> <tr> <th>Step</th> <th>Temperature(°C)</th> </tr> </thead> <tbody> <tr> <td>1</td> <td>Reference temp. ± 2</td> </tr> <tr> <td>2</td> <td>Min. operating temp. ± 2</td> </tr> <tr> <td>3</td> <td>Reference temp. ± 2</td> </tr> <tr> <td>4</td> <td>Max. operating temp. ± 2</td> </tr> </tbody> </table> <p>As for Min./Max. operating temp and Reference temp., please refer to "3.OPERATING TEMPERATURE RANGE"  Apply a voltage of 1/2 rated voltage.  As for measuring voltage, please contact with our sales representative.</p>	Step	Temperature(°C)	1	Reference temp. ± 2	2	Min. operating temp. ± 2	3	Reference temp. ± 2	4	Max. operating temp. ± 2
Capacitance Change(%)																							
No voltage applied	With voltage Applied																						
X5R: ±15	Please contact with our sales representative.																						
X6S: ±22																							
X7R: ±15																							
X7S: ±22																							
B : ±10																							
Step	Temperature(°C)																						
1	Reference temp. ± 2																						
2	Min. operating temp. ± 2																						
3	Reference temp. ± 2																						
4	Max. operating temp. ± 2																						
7	Robustness of Terminations	No sign of termination coming off, breakage of ceramic, or other abnormal signs.	<p>Reflow solder the capacitors on a P.C.Board shown in Appendix2.  Apply a pushing force gradually at the center of a specimen in a horizontal direction of P.C.board.  Pushing force : 5N  (2N is applied for CGB1 and CGB2 type.)  Holding time : 10±1s</p> 																				

(continued)

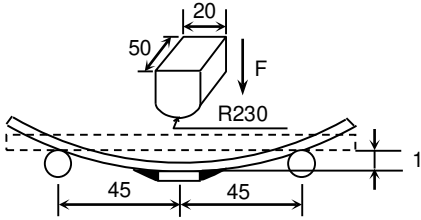
No.	Item	Performance	Test or inspection method								
8	Bending	No mechanical damage.	Reflow solder the capacitors on a P.C.Board shown in Appendix1 and bend it for 1mm.  <p style="text-align: right;">(Unit: mm)</p>								
9	Solderability	New solder to cover over 75% of termination. 25% may have pin holes or rough spots but not concentrated in one spot. Ceramic surface of A sections shall not be exposed due to melting or shifting of termination material.	Solder : Sn-3.0Ag-0.5Cu or Sn-37Pb Flux : Isopropyl alcohol (JIS K 8839) Rosin (JIS K 5902) 25% solid solution. Solder temp. : 245±5°C (Sn-3.0Ag-0.5Cu) 235±5°C (Sn-37Pb) Dwell time : 3±0.3s.(Sn-3.0Ag-0.5Cu) 2±0.2s.(Sn-37Pb) Solder position : Until both terminations are completely soaked.								
10	Resistance to solder heat	External appearance	No cracks are allowed and terminations shall be covered at least 60% with new solder.								
		Capacitance	<table border="1" style="width: 100%; border-collapse: collapse;"> <thead> <tr> <th style="width: 50%;">Characteristics</th> <th style="width: 50%;">Change from the value before test</th> </tr> </thead> <tbody> <tr> <td>X5R</td> <td rowspan="5" style="text-align: center; vertical-align: middle;">±7.5 %</td> </tr> <tr> <td>X6S</td> </tr> <tr> <td>X7R</td> </tr> <tr> <td>X7S</td> </tr> <tr> <td>B</td> </tr> </tbody> </table>	Characteristics	Change from the value before test	X5R	±7.5 %	X6S	X7R	X7S	B
		Characteristics	Change from the value before test								
		X5R	±7.5 %								
		X6S									
X7R											
X7S											
B											
D.F.	Meet the initial spec.										
Insulation Resistance	Meet the initial spec.										
Voltage proof	No insulation breakdown or other damage.										
Solder : Sn-3.0Ag-0.5Cu or Sn-37Pb Flux : Isopropyl alcohol (JIS K 8839) Rosin (JIS K 5902) 25% solid solution. Solder temp. : 260±5°C Dwell time : 10±1s. Solder position : Until both terminations are completely soaked. Pre-heating : Temp. — 110~140°C Time — 30~60s. Leaving time : 24±2h											



(continued)

No.	Item		Performance	Test or inspection method															
11	Vibration	External appearance	No mechanical damage.	Frequency : 10~55~10Hz Reciprocating sweep time : 1 min. Amplitude : 1.5mm Repeat this for 2h each in 3 perpendicular directions(Total 6h).  Reflow solder the capacitors on a P.C.Board shown in Appendix2 before testing.															
		Capacitance	<table border="1"> <thead> <tr> <th>Characteristics</th> <th>Change from the value before test</th> </tr> </thead> <tbody> <tr> <td>X5R X6S X7R X7S B</td> <td>±7.5 %</td> </tr> </tbody> </table>		Characteristics	Change from the value before test	X5R X6S X7R X7S B	±7.5 %											
			Characteristics		Change from the value before test														
X5R X6S X7R X7S B	±7.5 %																		
D.F.	Meet the initial spec.																		
12	Temperature cycle	External appearance	No mechanical damage.	Expose the capacitors in the condition step1 through step 4 listed in the following table.  Temp. cycle : 5 cycles <table border="1"> <thead> <tr> <th>Step</th> <th>Temperature(°C)</th> <th>Time (min.)</th> </tr> </thead> <tbody> <tr> <td>1</td> <td>Min. operating temp.±3</td> <td>30 ± 3</td> </tr> <tr> <td>2</td> <td>Ambient Temp.</td> <td>2 ~ 5</td> </tr> <tr> <td>3</td> <td>Max. operating temp.±2</td> <td>30 ± 2</td> </tr> <tr> <td>4</td> <td>Ambient Temp.</td> <td>2 ~ 5</td> </tr> </tbody> </table> As for Min./Max. operating temp., please refer to "3. OPERATING TEMPERATURE RANGE"  Leaving time : 24±2h  Reflow solder the capacitors on a P.C.Board shown in Appendix2 before testing.	Step	Temperature(°C)	Time (min.)	1	Min. operating temp.±3	30 ± 3	2	Ambient Temp.	2 ~ 5	3	Max. operating temp.±2	30 ± 2	4	Ambient Temp.	2 ~ 5
		Step	Temperature(°C)		Time (min.)														
		1	Min. operating temp.±3		30 ± 3														
		2	Ambient Temp.		2 ~ 5														
		3	Max. operating temp.±2		30 ± 2														
		4	Ambient Temp.		2 ~ 5														
Capacitance	<table border="1"> <thead> <tr> <th>Characteristics</th> <th>Change from the value before test</th> </tr> </thead> <tbody> <tr> <td>X5R X6S X7R X7S B</td> <td>Please contact with our sales representative.</td> </tr> </tbody> </table>	Characteristics	Change from the value before test	X5R X6S X7R X7S B	Please contact with our sales representative.														
	Characteristics	Change from the value before test																	
X5R X6S X7R X7S B	Please contact with our sales representative.																		
D.F.	Meet the initial spec.																		
Insulation Resistance	Meet the initial spec.																		
Voltage proof	No insulation breakdown or other damage.																		
13	Moisture Resistance (Steady State)	External appearance	No mechanical damage.	Test temp. : 40±2°C Test humidity : 90~95%RH Test time : 500 +24,0h Leaving time : 24±2h  Reflow solder the capacitors on a P.C.Board shown in Appendix2 before testing.															
		Capacitance	<table border="1"> <thead> <tr> <th>Characteristics</th> <th>Change from the value before test</th> </tr> </thead> <tbody> <tr> <td>X5R X6S X7R X7S B</td> <td>Please contact with our sales representative.</td> </tr> </tbody> </table>		Characteristics	Change from the value before test	X5R X6S X7R X7S B	Please contact with our sales representative.											
			Characteristics		Change from the value before test														
		X5R X6S X7R X7S B	Please contact with our sales representative.																
D.F.	200% of initial spec max.																		
Insulation Resistance	Please refer to the TABLE A in the end of the specification.  SPEC type A : 50MΩ·μF min. SPEC type B :10MΩ·μF min.																		

(continued)

No.	Item		Performance	Test or inspection method	
14	Moisture Resistance	External appearance	No mechanical damage.	Test temp. : 40±2°C Test humidity : 90~95%RH Applied voltage : Rated voltage Test time : 500 +24,0h Charge/discharge current : 50mA or lower Leaving time : 24±2h  Reflow solder the capacitors on a P.C.Board shown in Appendix2 before testing.  Initial value setting Voltage conditioning 《After voltage treat the capacitors under testing temperature and voltage for 1 hour,》 leave the capacitors in ambient condition for 24±2h before measurement. Use this measurement for initial value.	
		Capacitance	Characteristics		Change from the value before test
			X5R X6S X7R X7S B		Please contact with our sales representative.
		D.F.	200% of initial spec max.		
Insulation Resistance	Please refer to the TABLE A in the end of the specification.  SPEC type A : 25MΩ·μF min. SPEC type B : 5MΩ·μF min.				
15	Life	External appearance	No mechanical damage.	Test temp. : Maximum operating temperature±2°C Applied voltage : Please contact with our sales representative. Test time : 1,000 +48,0h Charge/discharge current : 50mA or lower Leaving time : 24±2h  Reflow solder the capacitors on a P.C.Board shown in Appendix2 before testing.  Initial value setting Voltage conditioning 《After voltage treat the capacitors under testing temperature and voltage for 1 hour,》 leave the capacitors in ambient condition for 24±2h before measurement. Use this measurement for initial value.	
		Capacitance	Characteristics		Change from the value before test
			X5R X6S X7R X7S B		Please contact with our sales representative.
		D.F.	200% of initial spec max.		
Insulation Resistance	Please refer to the TABLE A in the end of the specification.  SPEC type A : 50MΩ·μF min. SPEC type B : 10MΩ·μF min.				

\*As for the initial measurement of capacitors on number 6,10,11,12 and 13, leave capacitors at 150 0,-10°C for 1h and measure the value after leaving capacitors for 24±2h in ambient condition.



## 7. INSIDE STRUCTURE AND MATERIAL

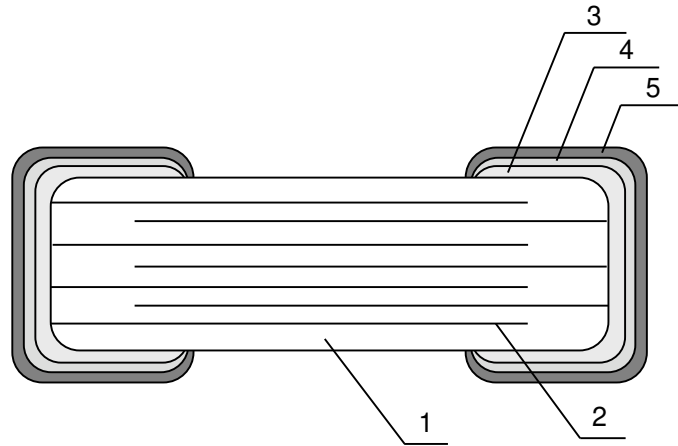

No.	NAME	MATERIAL
1	Dielectric	BaTiO <sub>3</sub>
2	Electrode	Nickel (Ni)
3	Termination	Copper (Cu)
4		Nickel (Ni)
5		Tin (Sn)

## 8. PACKAGING

Packaging shall be done to protect the components from the damage during transportation and storing, and a label which has the following information shall be attached.

8.1 Each plastic bag for bulk packaging contains 1000pcs. And the minimum quantity for Bulk packaging is 1000pcs.

8.2 Tape packaging is as per 11. TAPE PACKAGING SPECIFICATION.

\* CGB1 [CC0201] and CGB2 [CC0402] types are applicable to tape packaging only.

Information on label

- 1) Inspection No.\*
- 2) TDK P/N
- 3) Customer's P/N
- 4) Quantity

\*Composition of Inspection No.

Example    F 9 A - 23 - 001  
                   (a) (b) (c)        (d)        (e)

- (a) Line code
- (b) Last digit of the year
- (c) Month and A for January and B for February and so on. (Skip I)
- (d) Inspection Date of the month.
- (e) Serial No. of the day

\*Composition of new Inspection No.

(Will be implemented on and after May 1, 2019)

Example    

I	F	9	E	2	3	A	0	0	1
---	---	---	---	---	---	---	---	---	---

  
                   (a) (b) (c) (d)    (e)        (f)        (g)

- (a) Prefix
- (b) Line code
- (c) Last digit of the year
- (d) Month and A for January and B for February and so on. (Skip I)
- (e) Inspection Date of the month.
- (f) Serial No. of the day(00 ~ ZZ)
- (g) Suffix(00 ~ ZZ)

\*It is planned to shift to the new inspection No. on and after May 2019, but the implementation timing may be different depending on shipment bases.  
 Until the shift is completed, either current or new composition of inspection No. will be applied.

## 9. SOLDERING CONDITION

As for CGB1 [CC0201] and CGB2 [CC0402] type, reflow soldering only.

### 10. CAUTION

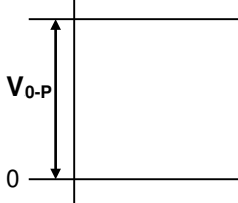
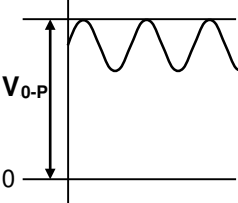
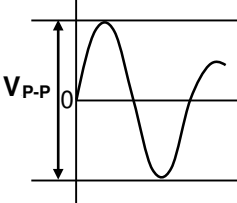
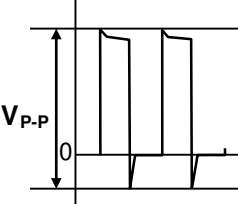
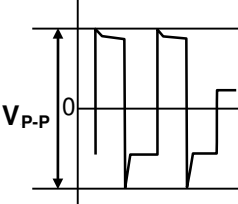
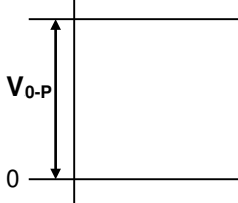
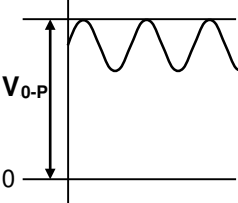
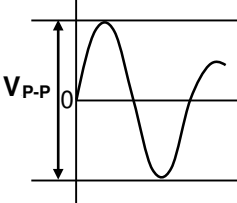
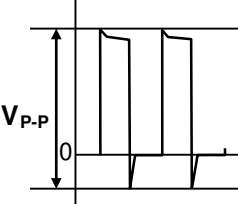
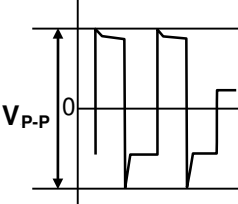
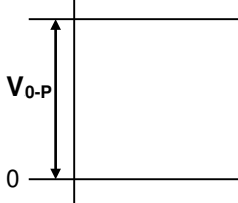
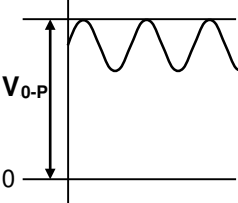
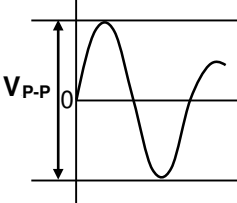
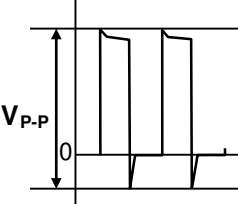
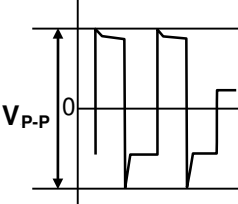
No.	Process	Condition														
1	Operating Condition (Storage, Use, Transportation)	1-1. Storage, Use 1) The capacitors must be stored in an ambient temperature of 5 to 40°C with a relative humidity of 20 to 70%RH. The products should be used within 6 months upon receipt. The capacitors must be operated and stored in an environment free of dew 2) condensation and these gases such as Hydrogen Sulphide, Hydrogen Sulphate, Chlorine, Ammonia and sulfur. 3) Avoid storing in sun light and falling of dew. 4) Do not use capacitors under high humidity and high and low atmospheric pressure which may affect capacitors reliability. 5) Capacitors should be tested for the solderability when they are stored for long time.  1-2. Handling in transportation In case of the transportation of the capacitors, the performance of the capacitors may be deteriorated depending on the transportation condition. (Refer to JEITA RCR-2335C 9.2 Handling in transportation)														
2	Circuit design  Caution	2-1. Operating temperature Operating temperature should be followed strictly within this specification, especially be careful with maximum temperature. 1) Do not use capacitors above the maximum allowable operating temperature. 2) Surface temperature including self heating should be below maximum operating temperature. (Due to dielectric loss, capacitors will heat itself when AC is applied. Especially at high frequencies around its SRF, the heat might be so extreme that it may damage itself or the product mounted on. Please design the circuit so that the maximum temperature of the capacitors including the self heating to be below the maximum allowable operating temperature. Temperature rise at capacitor surface shall be below 20°C) The electrical characteristics of the capacitors will vary depending on the 3) temperature. The capacitors should be selected and designed in taking the temperature into consideration.  2-2. Operating voltage 1) Operating voltage across the terminals should be below the rated voltage. When AC and DC are super imposed, $V_{0-P}$ must be below the rated voltage. — (1) and (2) AC or pulse with overshooting, $V_{P-P}$ must be below the rated voltage. — (3), (4) and (5) When the voltage is started to apply to the circuit or it is stopped applying, the irregular voltage may be generated for a transit period because of resonance or switching. Be sure to use the capacitors within rated voltage containing these Irregular voltage. <table border="1" data-bbox="443 1480 1422 2063"> <thead> <tr> <th data-bbox="443 1480 635 1525">Voltage</th> <th data-bbox="635 1480 895 1525">(1) DC voltage</th> <th data-bbox="895 1480 1155 1525">(2) DC+AC voltage</th> <th data-bbox="1155 1480 1422 1525">(3) AC voltage</th> </tr> </thead> <tbody> <tr> <td data-bbox="443 1525 635 1756">                     Positional Measurement (Rated voltage)                 </td> <td data-bbox="635 1525 895 1756">  </td> <td data-bbox="895 1525 1155 1756">  </td> <td data-bbox="1155 1525 1422 1756">  </td> </tr> <tr> <th data-bbox="443 1783 635 1827">Voltage</th> <th data-bbox="635 1783 895 1827">(4) Pulse voltage (A)</th> <th data-bbox="895 1783 1155 1827">(5) Pulse voltage (B)</th> </tr> <tr> <td data-bbox="443 1827 635 2063">                     Positional Measurement (Rated voltage)                 </td> <td data-bbox="635 1827 895 2063">  </td> <td data-bbox="895 1827 1155 2063">  </td> </tr> </tbody> </table>	Voltage	(1) DC voltage	(2) DC+AC voltage	(3) AC voltage	Positional Measurement (Rated voltage)				Voltage	(4) Pulse voltage (A)	(5) Pulse voltage (B)	Positional Measurement (Rated voltage)		
Voltage	(1) DC voltage	(2) DC+AC voltage	(3) AC voltage													
Positional Measurement (Rated voltage)																
Voltage	(4) Pulse voltage (A)	(5) Pulse voltage (B)														
Positional Measurement (Rated voltage)																

No.	Process	Condition																																
2	Circuit design ⚠ Caution	<p>2) Even below the rated voltage, if repetitive high frequency AC or pulse is applied, the reliability of the capacitors may be reduced.</p> <p>3) The effective capacitance will vary depending on applied DC and AC voltages. The capacitors should be selected and designed in taking the voltages into consideration.</p> <p>2-3. Frequency When the capacitors are used in AC and/or pulse voltages, the capacitors may vibrate themselves and generate audible sound.</p>																																
3	Designing P.C.board	<p>The amount of solder at the terminations has a direct effect on the reliability of the capacitors.</p> <p>1) The greater the amount of solder, the higher the stress on the chip capacitors, and the more likely that it will break. When designing a P.C.board, determine the shape and size of the solder lands to have proper amount of solder on the terminations.</p> <p>2) Avoid using common solder land for multiple terminations and provide individual solder land for each terminations.</p> <p>3) Size and recommended land dimensions.</p> <div data-bbox="678 940 1396 1232" style="text-align: center;"> </div> <table border="1" data-bbox="510 1321 1061 1568" style="margin-left: auto; margin-right: auto;"> <caption>Flow soldering (Unit : mm)</caption> <thead> <tr> <th>Case size</th> <th>CGB3 [CC0603]</th> <th>CGB4 [CC0805]</th> </tr> </thead> <tbody> <tr> <td>A</td> <td>0.7 ~ 1.0</td> <td>1.0 ~ 1.3</td> </tr> <tr> <td>B</td> <td>0.8 ~ 1.0</td> <td>1.0 ~ 1.2</td> </tr> <tr> <td>C</td> <td>0.6 ~ 0.8</td> <td>0.8 ~ 1.1</td> </tr> </tbody> </table> <table border="1" data-bbox="510 1601 1412 1848" style="margin-left: auto; margin-right: auto;"> <caption>Reflow soldering (Unit : mm)</caption> <thead> <tr> <th>Case size</th> <th>CGB1 [CC0201]</th> <th>CGB2 [CC0402]</th> <th>CGB3 [CC0603]</th> <th>CGB4 [CC0805]</th> </tr> </thead> <tbody> <tr> <td>A</td> <td>0.25 ~ 0.35</td> <td>0.3 ~ 0.5</td> <td>0.6 ~ 0.8</td> <td>0.9 ~ 1.2</td> </tr> <tr> <td>B</td> <td>0.2 ~ 0.3</td> <td>0.35 ~ 0.45</td> <td>0.6 ~ 0.8</td> <td>0.7 ~ 0.9</td> </tr> <tr> <td>C</td> <td>0.25 ~ 0.35</td> <td>0.4 ~ 0.6</td> <td>0.6 ~ 0.8</td> <td>0.9 ~ 1.2</td> </tr> </tbody> </table>	Case size	CGB3 [CC0603]	CGB4 [CC0805]	A	0.7 ~ 1.0	1.0 ~ 1.3	B	0.8 ~ 1.0	1.0 ~ 1.2	C	0.6 ~ 0.8	0.8 ~ 1.1	Case size	CGB1 [CC0201]	CGB2 [CC0402]	CGB3 [CC0603]	CGB4 [CC0805]	A	0.25 ~ 0.35	0.3 ~ 0.5	0.6 ~ 0.8	0.9 ~ 1.2	B	0.2 ~ 0.3	0.35 ~ 0.45	0.6 ~ 0.8	0.7 ~ 0.9	C	0.25 ~ 0.35	0.4 ~ 0.6	0.6 ~ 0.8	0.9 ~ 1.2
Case size	CGB3 [CC0603]	CGB4 [CC0805]																																
A	0.7 ~ 1.0	1.0 ~ 1.3																																
B	0.8 ~ 1.0	1.0 ~ 1.2																																
C	0.6 ~ 0.8	0.8 ~ 1.1																																
Case size	CGB1 [CC0201]	CGB2 [CC0402]	CGB3 [CC0603]	CGB4 [CC0805]																														
A	0.25 ~ 0.35	0.3 ~ 0.5	0.6 ~ 0.8	0.9 ~ 1.2																														
B	0.2 ~ 0.3	0.35 ~ 0.45	0.6 ~ 0.8	0.7 ~ 0.9																														
C	0.25 ~ 0.35	0.4 ~ 0.6	0.6 ~ 0.8	0.9 ~ 1.2																														

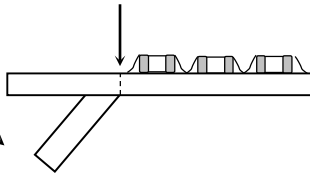
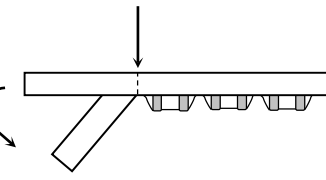
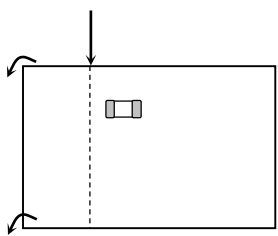
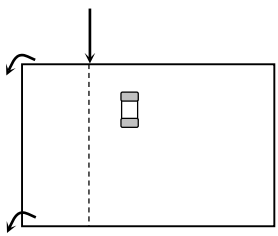
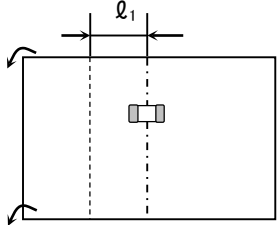
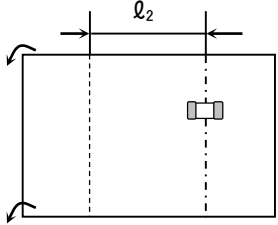
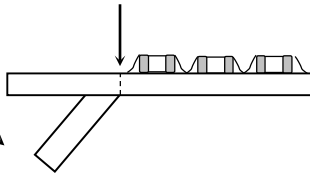
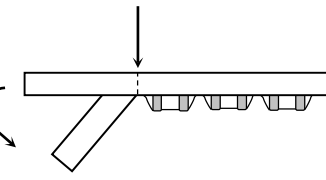
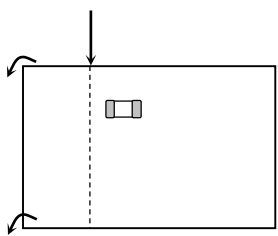
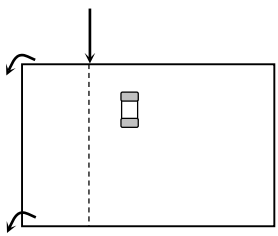
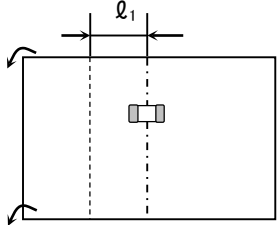
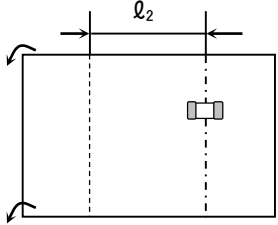
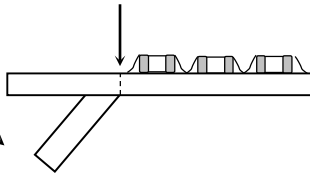
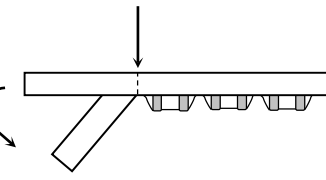
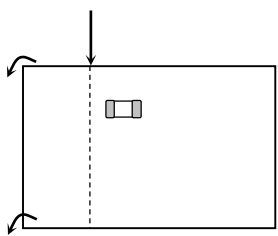
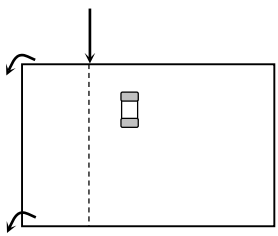
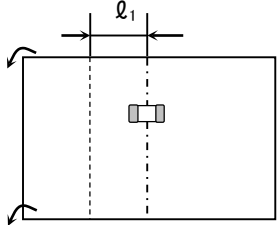
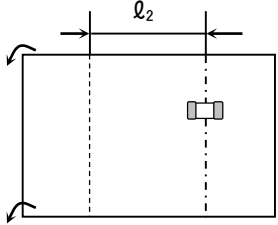
No.	Process	Condition												
3	Designing P.C.board	<p>4) Recommended chip capacitors layout is as following.</p> <table border="1" style="width: 100%; border-collapse: collapse;"> <thead> <tr> <th data-bbox="475 286 662 365"></th> <th data-bbox="662 286 1046 365">Disadvantage against bending stress</th> <th data-bbox="1046 286 1431 365">Advantage against bending stress</th> </tr> </thead> <tbody> <tr> <td data-bbox="475 365 662 779">Mounting face</td> <td data-bbox="662 365 1046 779"> <p style="text-align: center;">Perforation or slit</p>  <p style="text-align: center;">Break P.C.board with mounted side up.</p> </td> <td data-bbox="1046 365 1431 779"> <p style="text-align: center;">Perforation or slit</p>  <p style="text-align: center;">Break P.C.board with mounted side down.</p> </td> </tr> <tr> <td data-bbox="475 779 662 1227">Chip arrangement (Direction)</td> <td data-bbox="662 779 1046 1227"> <p style="text-align: center;">Perforation or slit</p>  </td> <td data-bbox="1046 779 1431 1227"> <p style="text-align: center;">Perforation or slit</p>  </td> </tr> <tr> <td data-bbox="475 1227 662 1709">Distance from slit</td> <td data-bbox="662 1227 1046 1709"> <p style="text-align: center;">Closer to slit is higher stress</p>  <p style="text-align: center;"><math>( l_1 &lt; l_2 )</math></p> </td> <td data-bbox="1046 1227 1431 1709"> <p style="text-align: center;">Away from slit is less stress</p>  <p style="text-align: center;"><math>( l_1 &lt; l_2 )</math></p> </td> </tr> </tbody> </table>		Disadvantage against bending stress	Advantage against bending stress	Mounting face	<p style="text-align: center;">Perforation or slit</p>  <p style="text-align: center;">Break P.C.board with mounted side up.</p>	<p style="text-align: center;">Perforation or slit</p>  <p style="text-align: center;">Break P.C.board with mounted side down.</p>	Chip arrangement (Direction)	<p style="text-align: center;">Perforation or slit</p> 	<p style="text-align: center;">Perforation or slit</p> 	Distance from slit	<p style="text-align: center;">Closer to slit is higher stress</p>  <p style="text-align: center;"><math>( l_1 &lt; l_2 )</math></p>	<p style="text-align: center;">Away from slit is less stress</p>  <p style="text-align: center;"><math>( l_1 &lt; l_2 )</math></p>
	Disadvantage against bending stress	Advantage against bending stress												
Mounting face	<p style="text-align: center;">Perforation or slit</p>  <p style="text-align: center;">Break P.C.board with mounted side up.</p>	<p style="text-align: center;">Perforation or slit</p>  <p style="text-align: center;">Break P.C.board with mounted side down.</p>												
Chip arrangement (Direction)	<p style="text-align: center;">Perforation or slit</p> 	<p style="text-align: center;">Perforation or slit</p> 												
Distance from slit	<p style="text-align: center;">Closer to slit is higher stress</p>  <p style="text-align: center;"><math>( l_1 &lt; l_2 )</math></p>	<p style="text-align: center;">Away from slit is less stress</p>  <p style="text-align: center;"><math>( l_1 &lt; l_2 )</math></p>												

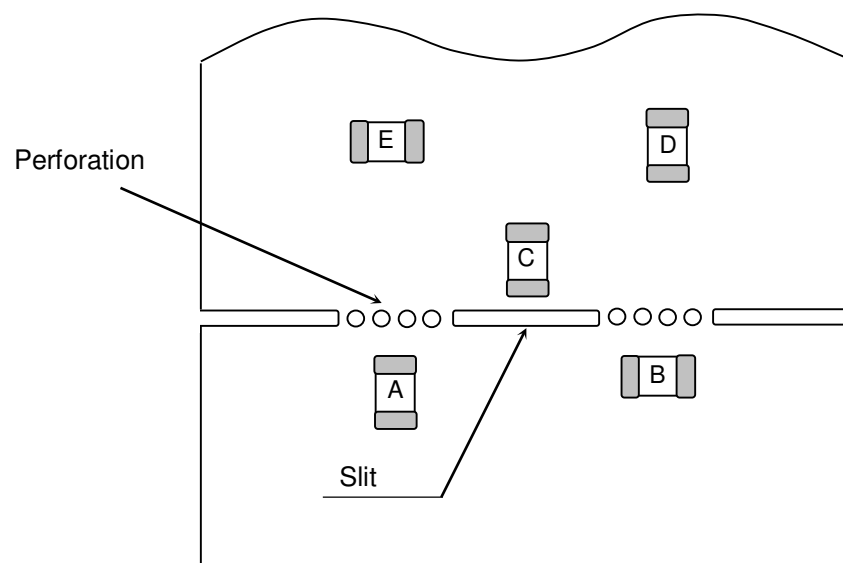
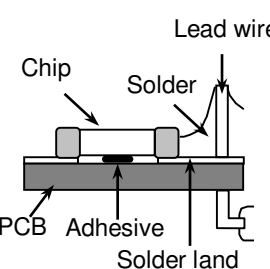
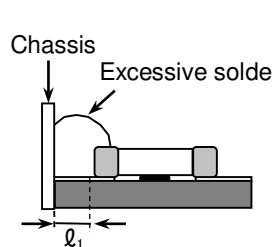
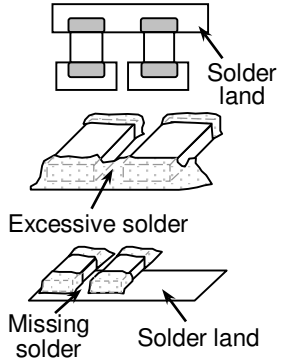
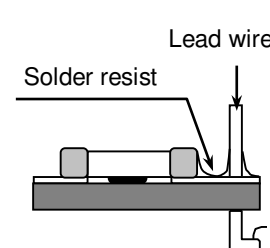
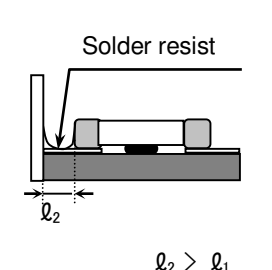
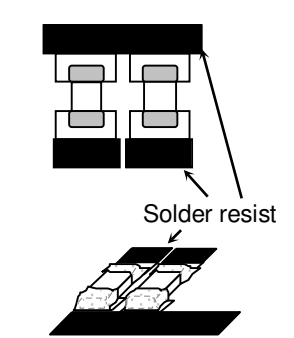
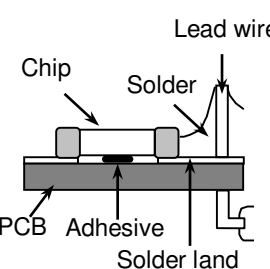
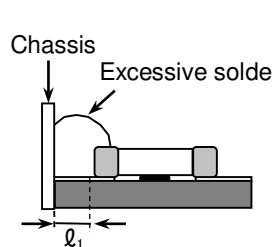
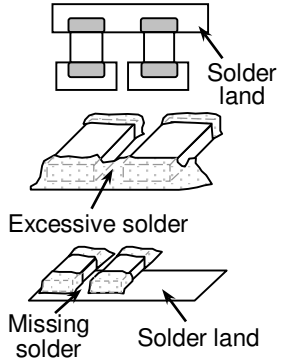
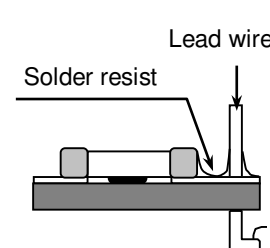
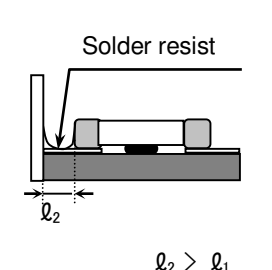
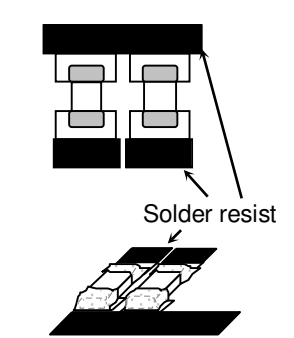
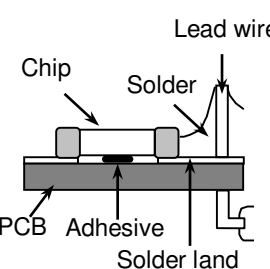
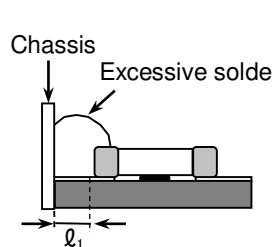
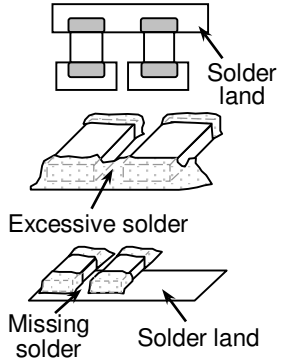
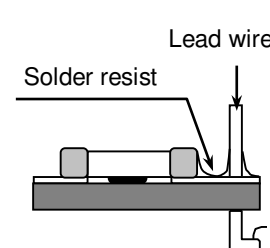
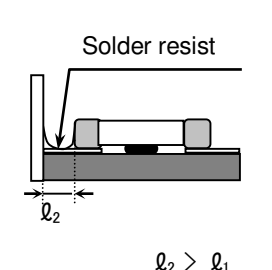
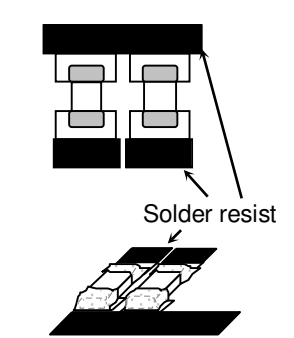

No.	Process	Condition												
3	Designing P.C.board	<p>5) Mechanical stress varies according to location of chip capacitors on the P.C.board.</p>  <p>The stress in capacitors is in the following order.  <math>A &gt; B = C &gt; D &gt; E</math></p> <p>6) Layout recommendation</p> <table border="1" data-bbox="375 1086 1484 1993"> <thead> <tr> <th data-bbox="375 1086 542 1198">Example</th> <th data-bbox="542 1086 845 1198">Use of common solder land</th> <th data-bbox="845 1086 1157 1198">Soldering with chassis</th> <th data-bbox="1157 1086 1484 1198">Use of common solder land with other SMD</th> </tr> </thead> <tbody> <tr> <td data-bbox="375 1198 542 1579">Need to avoid</td> <td data-bbox="542 1198 845 1579">  </td> <td data-bbox="845 1198 1157 1579">  </td> <td data-bbox="1157 1198 1484 1579">  </td> </tr> <tr> <td data-bbox="375 1579 542 1993">Recommendation</td> <td data-bbox="542 1579 845 1993">  </td> <td data-bbox="845 1579 1157 1993">  </td> <td data-bbox="1157 1579 1484 1993">  </td> </tr> </tbody> </table>	Example	Use of common solder land	Soldering with chassis	Use of common solder land with other SMD	Need to avoid				Recommendation			
Example	Use of common solder land	Soldering with chassis	Use of common solder land with other SMD											
Need to avoid														
Recommendation														

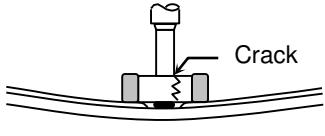
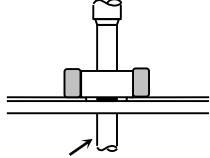
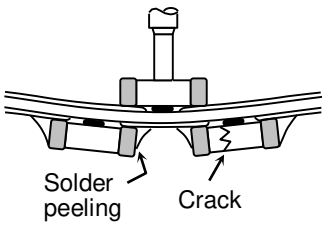
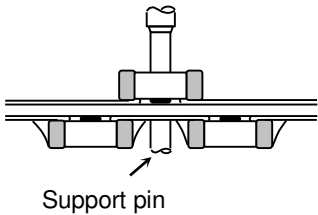
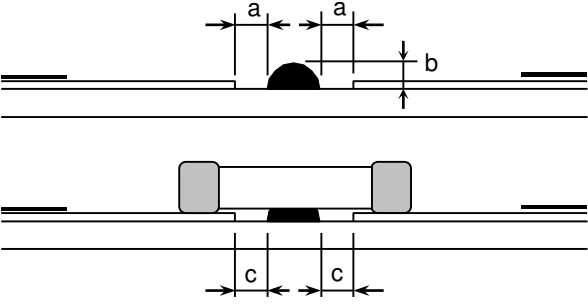
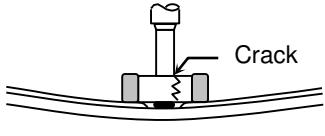
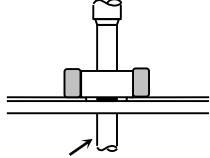
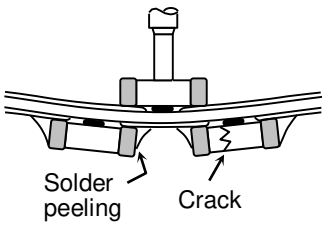
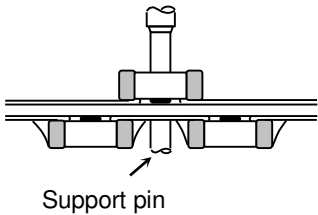
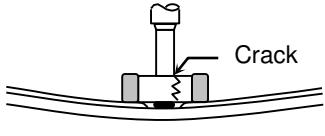
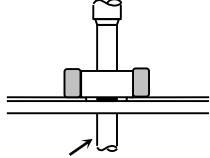
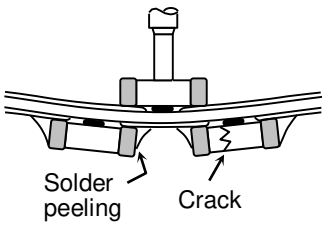
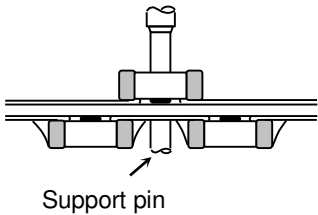
No.	Process	Condition															
4	Mounting	<p>4-1. Stress from mounting head                      If the mounting head is adjusted too low, it may induce excessive stress in the chip capacitors to result in cracking. Please take following precautions.</p> <ol style="list-style-type: none"> <li>1) Adjust the bottom dead center of the mounting head to reach on the P.C.board surface and not press it.</li> <li>2) Adjust the mounting head pressure to be 1 to 3N of static weight.</li> <li>3) To minimize the impact energy from mounting head, it is important to provide support from the bottom side of the P.C.board.                      See following examples.</li> </ol> <table border="1" style="width: 100%; border-collapse: collapse;"> <thead> <tr> <th style="width: 30%;"></th> <th style="width: 35%;">Not recommended</th> <th style="width: 35%;">Recommended</th> </tr> </thead> <tbody> <tr> <td style="text-align: center; vertical-align: middle;">Single-sided mounting</td> <td style="text-align: center;">  </td> <td style="text-align: center;">  </td> </tr> <tr> <td style="text-align: center; vertical-align: middle;">Double-sides mounting</td> <td style="text-align: center;">  </td> <td style="text-align: center;">  </td> </tr> </tbody> </table> <p>When the centering jaw is worn out, it may give mechanical impact on the capacitors to cause crack. Please control the close up dimension of the centering jaw and provide sufficient preventive maintenance and replacement of it.</p> <p>4-2. Amount of adhesive</p> <div style="text-align: center;">  </div> <p style="text-align: center;">Example : CGB4 (CC0805)</p> <table border="1" style="width: 100%; border-collapse: collapse;"> <tbody> <tr> <td style="width: 15%; text-align: center;">a</td> <td style="text-align: center;">0.2mm min.</td> </tr> <tr> <td style="text-align: center;">b</td> <td style="text-align: center;">70 ~ 100μm</td> </tr> <tr> <td style="text-align: center;">c</td> <td style="text-align: center;">Do not touch the solder land</td> </tr> </tbody> </table>		Not recommended	Recommended	Single-sided mounting			Double-sides mounting			a	0.2mm min.	b	70 ~ 100μm	c	Do not touch the solder land
	Not recommended	Recommended															
Single-sided mounting																	
Double-sides mounting																	
a	0.2mm min.																
b	70 ~ 100μm																
c	Do not touch the solder land																

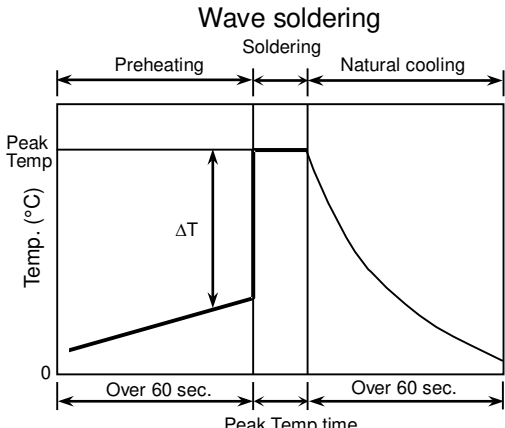
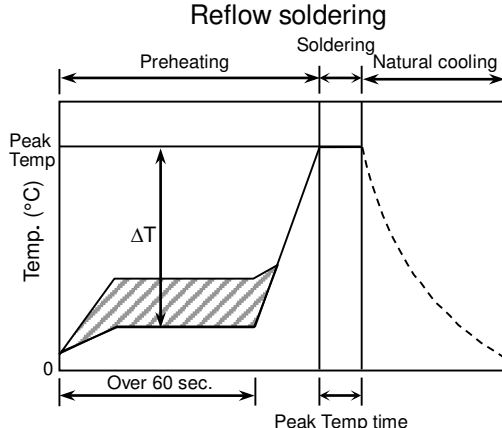
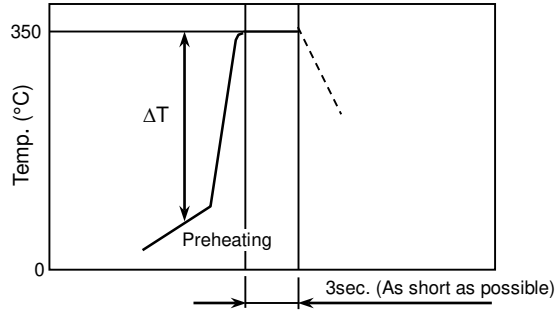
No.	Process	Condition																			
5	Soldering	<p>5-1. Flux selection                      Flux can seriously affect the performance of capacitors. Confirm the following to select the appropriate flux.</p> <ol style="list-style-type: none"> <li>1) It is recommended to use a mildly activated rosin flux (less than 0.1wt% chlorine). Strong flux is not recommended.</li> <li>2) Excessive flux must be avoided. Please provide proper amount of flux.</li> <li>3) When water-soluble flux is used, enough washing is necessary.</li> </ol> <p>5-2. Recommended soldering profile by various methods</p> <div style="display: flex; justify-content: space-around;"> <div style="text-align: center;"> <p><b>Wave soldering</b></p>  </div> <div style="text-align: center;"> <p><b>Reflow soldering</b></p>  </div> </div> <div style="text-align: center; margin-top: 20px;"> <p><b>Manual soldering (Solder iron)</b></p>  </div> <div style="margin-top: 20px;"> <p><b>APPLICATION</b>                      As for CGB3 [CC0603] and CGB4 [CC0805] applied to wave soldering and reflow soldering.                      As for other case sizes, applied only to reflow soldering.</p> </div> <p>5-3. Recommended soldering peak temp and peak temp duration</p> <table border="1" style="width: 100%; border-collapse: collapse;"> <thead> <tr> <th rowspan="2" style="text-align: center;">Temp./Duration</th> <th colspan="2" style="text-align: center;">Wave soldering</th> <th colspan="2" style="text-align: center;">Reflow soldering</th> </tr> <tr> <th style="text-align: center;">Peak temp(°C)</th> <th style="text-align: center;">Duration(sec.)</th> <th style="text-align: center;">Peak temp(°C)</th> <th style="text-align: center;">Duration(sec.)</th> </tr> </thead> <tbody> <tr> <td style="text-align: center;">Sn-Pb Solder</td> <td style="text-align: center;">250 max.</td> <td style="text-align: center;">3 max.</td> <td style="text-align: center;">230 max.</td> <td style="text-align: center;">20 max.</td> </tr> <tr> <td style="text-align: center;">Lead Free Solder</td> <td style="text-align: center;">260 max.</td> <td style="text-align: center;">5 max.</td> <td style="text-align: center;">260 max.</td> <td style="text-align: center;">10 max.</td> </tr> </tbody> </table> <p>Recommended solder compositions                      Lead Free Solder : Sn-3.0Ag-0.5Cu                      Sn-Pb Solder : Sn-37Pb</p>	Temp./Duration	Wave soldering		Reflow soldering		Peak temp(°C)	Duration(sec.)	Peak temp(°C)	Duration(sec.)	Sn-Pb Solder	250 max.	3 max.	230 max.	20 max.	Lead Free Solder	260 max.	5 max.	260 max.	10 max.
Temp./Duration	Wave soldering			Reflow soldering																	
	Peak temp(°C)	Duration(sec.)	Peak temp(°C)	Duration(sec.)																	
Sn-Pb Solder	250 max.	3 max.	230 max.	20 max.																	
Lead Free Solder	260 max.	5 max.	260 max.	10 max.																	

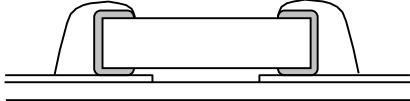
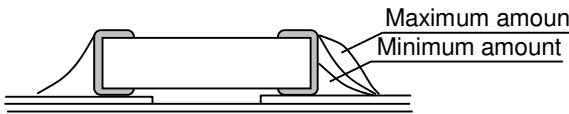
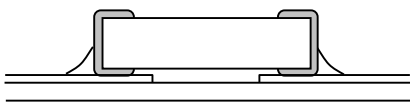
No.	Process	Condition																
5	Soldering	<p>5-4. Avoiding thermal shock</p> <p>1) Preheating condition</p> <table border="1" data-bbox="555 286 1139 432"> <thead> <tr> <th>Soldering</th> <th>Temp. (°C)</th> </tr> </thead> <tbody> <tr> <td>Wave soldering</td> <td><math>\Delta T \leq 150</math></td> </tr> <tr> <td>Reflow soldering</td> <td><math>\Delta T \leq 150</math></td> </tr> <tr> <td>Manual soldering</td> <td><math>\Delta T \leq 150</math></td> </tr> </tbody> </table> <p>2) Cooling condition Natural cooling using air is recommended. If the chips are dipped into a solvent for cleaning, the temperature difference (<math>\Delta T</math>) must be less than 100°C.</p> <p>5-5. Amount of solder Excessive solder will induce higher tensile force in chip capacitors when temperature changes and it may result in chip cracking. In sufficient solder may detach the capacitors from the P.C.board.</p> <div style="display: flex; justify-content: space-between; align-items: flex-start;"> <div data-bbox="496 842 635 909" style="width: 30%;">Excessive solder</div> <div data-bbox="699 831 1110 931" style="width: 35%; text-align: center;">  </div> <div data-bbox="1134 824 1430 920" style="width: 30%;">Higher tensile force in chip capacitors to cause crack</div> </div> <hr/> <div style="display: flex; justify-content: space-between; align-items: center;"> <div data-bbox="496 1010 635 1043" style="width: 30%;">Adequate</div> <div data-bbox="699 965 1270 1077" style="width: 35%; text-align: center;">  </div> </div> <hr/> <div style="display: flex; justify-content: space-between; align-items: flex-start;"> <div data-bbox="496 1144 643 1211" style="width: 30%;">Insufficient solder</div> <div data-bbox="699 1133 1110 1234" style="width: 35%; text-align: center;">  </div> <div data-bbox="1134 1122 1430 1234" style="width: 30%;">Low robustness may cause contact failure or chip capacitors come off the P.C.board.</div> </div> <hr/> <p>5-6. Solder repair by solder iron</p> <p>1) Selection of the soldering iron tip Tip temperature of solder iron varies by its type, P.C.board material and solder land size. The higher the tip temperature, the quicker the operation. However, heat shock may cause a crack in the chip capacitors. Please make sure the tip temp. before soldering and keep the peak temp and time in accordance with following recommended condition.</p> <p style="text-align: center;">Recommended solder iron condition (Sn-Pb Solder and Lead Free Solder)</p> <table border="1" data-bbox="555 1592 1390 1697"> <thead> <tr> <th>Temp. (°C)</th> <th>Duration (sec.)</th> <th>Wattage (W)</th> <th>Shape (mm)</th> </tr> </thead> <tbody> <tr> <td>350 max.</td> <td>3 max.</td> <td>20 max.</td> <td>∅ 3.0 max.</td> </tr> </tbody> </table> <p>* Please preheat the chip capacitors with the condition in 5-4 to avoid the thermal shock.</p> <p>2) Direct contact of the soldering iron with ceramic dielectric of chip capacitors may cause crack. Do not touch the ceramic dielectric and the terminations by solder iron.</p>	Soldering	Temp. (°C)	Wave soldering	$\Delta T \leq 150$	Reflow soldering	$\Delta T \leq 150$	Manual soldering	$\Delta T \leq 150$	Temp. (°C)	Duration (sec.)	Wattage (W)	Shape (mm)	350 max.	3 max.	20 max.	∅ 3.0 max.
Soldering	Temp. (°C)																	
Wave soldering	$\Delta T \leq 150$																	
Reflow soldering	$\Delta T \leq 150$																	
Manual soldering	$\Delta T \leq 150$																	
Temp. (°C)	Duration (sec.)	Wattage (W)	Shape (mm)															
350 max.	3 max.	20 max.	∅ 3.0 max.															

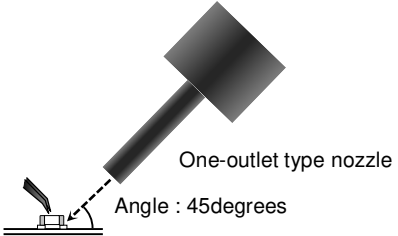
No.	Process	Condition												
5	Soldering	<p>5-7.Soldering rework using spot heater Heat stress during rework may possibly be reduced by using a spot heater (also called a “blower”) rather than a soldering iron. It is applied only to adding solder in the case of insufficient solder amount.</p> <p>1) Reworking using a spot heater may suppress the occurrence of cracks in the capacitor compared to using a soldering iron. A spot heater can heat up a capacitor uniformly with a small heat gradient which leads to lower thermal stress caused by quick heating and cooling or localized heating. Moreover, where ultra-small capacitors are mounted close together on a printed circuit board, reworking with a spot heater can eliminate the risk of direct contact between the tip of a soldering iron and a capacitor.</p> <p>2) Rework condition If the blower nozzle of a spot heater is too close to a capacitor, a crack in the capacitor may occur due to heat stress. Below are recommendations for avoiding such an occurrence. Keep more than 5mm between a capacitor and a spot heater nozzle. The blower temperature of the spot heater shall be lower than 400°C. The airflow shall be set as weak as possible. The diameter of the nozzle is recommended to be 2mm(one-outlet type).The size is standard and common. Duration of blowing hot air is recommended to be 10s or less for CGB3[CC0603], CGB4[CC0805], considering surface area of the capacitor and melting temperature of solder. The angle between the nozzle and the capacitor is recommended to be 45degrees in order to work easily and to avoid partial area heating. As is the case when using a soldering iron, preheating reduces thermal stress on capacitors and improves operating efficiency.</p> <ul style="list-style-type: none"> <li>Recommended rework condition (Consult the component manufactures for details.)</li> </ul> <table border="1" data-bbox="523 1189 1465 1550"> <tr> <td>Distance from nozzle</td> <td>5mm and over</td> </tr> <tr> <td>Nozzle angle</td> <td>45degrees</td> </tr> <tr> <td>Nozzle temp.</td> <td>400°C and less</td> </tr> <tr> <td>Airflow</td> <td>Set as weak as possible (The airflow shall be the minimum value necessary for solder to melt in the Conditions mentioned above.)</td> </tr> <tr> <td>Nozzle diameter</td> <td>∅ 2mm(one-outlet type)</td> </tr> <tr> <td>Blowing duration</td> <td>10s and less(CGB3[CC0603], CGB4[CC0805])</td> </tr> </table> <ul style="list-style-type: none"> <li>Example of recommended spot heater use</li> </ul>  <p>3) Amount of solder should be suitable to form a proper fillet shape. Excess solder causes mechanical and thermal stress on a capacitor and results in cracks. Insufficient solder causes weak adherence of the capacitor to the substrate and may result in detachment of a capacitor and deteriorate reliability of the printed wiring board. See the example of appropriate solder fillet shape for 5-5.Amount of solder.</p>	Distance from nozzle	5mm and over	Nozzle angle	45degrees	Nozzle temp.	400°C and less	Airflow	Set as weak as possible (The airflow shall be the minimum value necessary for solder to melt in the Conditions mentioned above.)	Nozzle diameter	∅ 2mm(one-outlet type)	Blowing duration	10s and less(CGB3[CC0603], CGB4[CC0805])
Distance from nozzle	5mm and over													
Nozzle angle	45degrees													
Nozzle temp.	400°C and less													
Airflow	Set as weak as possible (The airflow shall be the minimum value necessary for solder to melt in the Conditions mentioned above.)													
Nozzle diameter	∅ 2mm(one-outlet type)													
Blowing duration	10s and less(CGB3[CC0603], CGB4[CC0805])													

No.	Process	Condition
5	Soldering	<p>5-8. Sn-Zn solder Sn-Zn solder affects product reliability. Please contact TDK in advance when utilize Sn-Zn solder.</p> <p>5-9. Countermeasure for tombstone The misalignment between the mounted positions of the capacitors and the land patterns should be minimized. The tombstone phenomenon may occur especially the capacitors are mounted (in longitudinal direction) in the same direction of the reflow soldering. (Refer to JEITA RCR-2335C Annex A (Informative) Recommendations to prevent the tombstone phenomenon)</p>
6	Cleaning	<p>1) If an unsuitable cleaning fluid is used, flux residue or some foreign articles may stick to chip capacitors surface to deteriorate especially the insulation resistance.</p> <p>2) If cleaning condition is not suitable, it may damage the chip capacitors.</p> <p>2)-1. Insufficient washing (1) Terminal electrodes may corrode by Halogen in the flux.  (2) Halogen in the flux may adhere on the surface of capacitors, and lower the insulation resistance.  (3) Water soluble flux has higher tendency to have above mentioned problems (1) and (2).</p> <p>2)-2. Excessive washing When ultrasonic cleaning is used, excessively high ultrasonic energy output can affect the connection between the ceramic chip capacitor's body and the terminal electrode. To avoid this, following is the recommended condition.  Power : 20 W/l max. Frequency : 40 kHz max. Washing time : 5 minutes max.</p> <p>2)-3. If the cleaning fluid is contaminated, density of Halogen increases, and it may bring the same result as insufficient cleaning.</p>
7	Coating and molding of the P.C.board	<p>1) When the P.C.board is coated, please verify the quality influence on the product.</p> <p>2) Please verify carefully that there is no harmful decomposing or reaction gas emission during curing which may damage the chip capacitors.</p> <p>3) Please verify the curing temperature.</p>

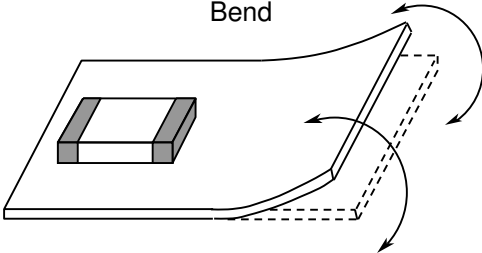
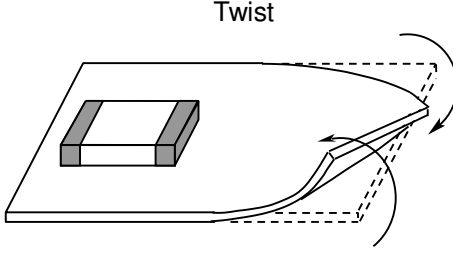
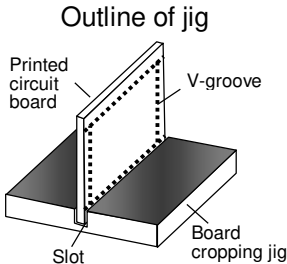
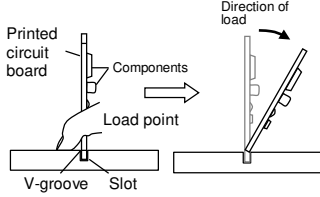
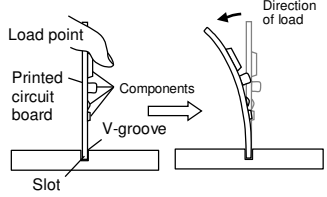
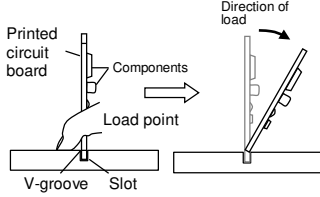
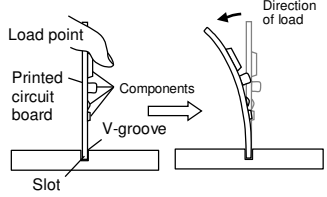
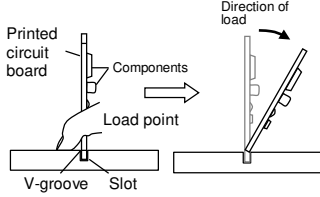
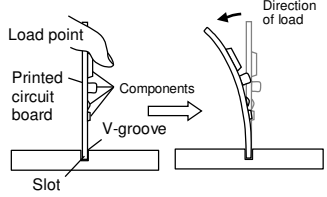
No.	Process	Condition				
8	Handling after chip mounted ⚠ Caution	<p>1) Please pay attention not to bend or distort the P.C.board after soldering in handling otherwise the chip capacitors may crack.</p> <div style="display: flex; justify-content: space-around; align-items: center;"> <div style="text-align: center;"> <p>Bend</p>  </div> <div style="text-align: center;"> <p>Twist</p>  </div> </div> <p>2) Printed circuit board cropping should not be carried out by hand, but by using the proper tooling. Printed circuit board cropping should be carried out using a board cropping jig as shown in the following figure or a board cropping apparatus to prevent inducing mechanical stress on the board.</p> <p>(1) Example of a board cropping jig</p> <p>Recommended example: The board should be pushed from the back side, close to the cropping jig so that the board is not bent and the stress applied to the capacitor is compressive.</p> <p>Unrecommended example: If the pushing point is far from the cropping jig and the pushing direction is from the front side of the board, large tensile stress is applied to the capacitor, which may cause cracks.</p> <div style="display: flex; justify-content: space-around; align-items: center;"> <div style="text-align: center;"> <p>Outline of jig</p>  </div> <table border="1" style="width: 100%; text-align: center;"> <thead> <tr> <th data-bbox="778 1003 1114 1048">Recommended</th> <th data-bbox="1114 1003 1457 1048">Unrecommended</th> </tr> </thead> <tbody> <tr> <td data-bbox="778 1048 1114 1265">  </td> <td data-bbox="1114 1048 1457 1265">  </td> </tr> </tbody> </table> </div>	Recommended	Unrecommended		
Recommended	Unrecommended					
						

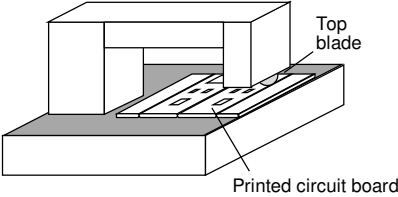
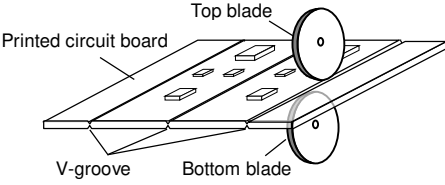
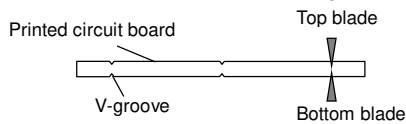
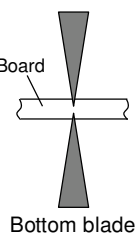
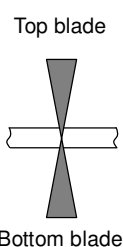
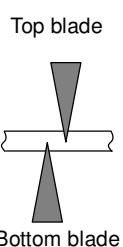
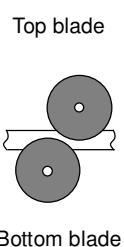
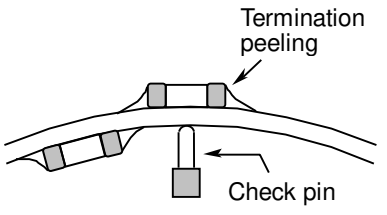
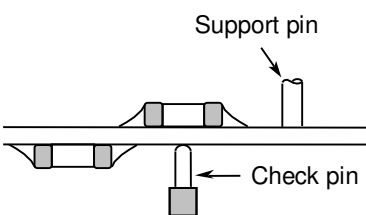
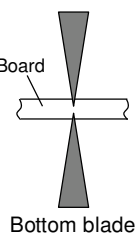
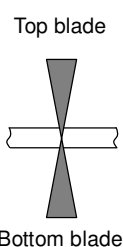
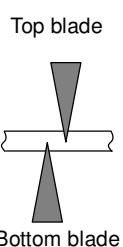
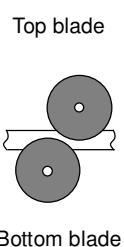
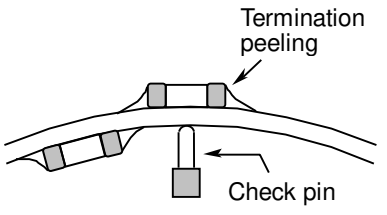
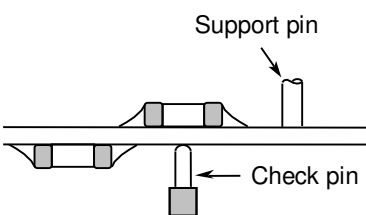
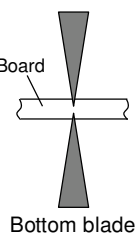
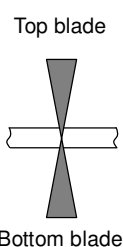
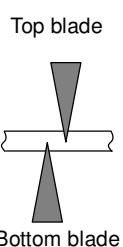
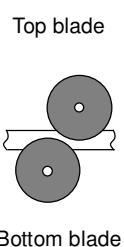
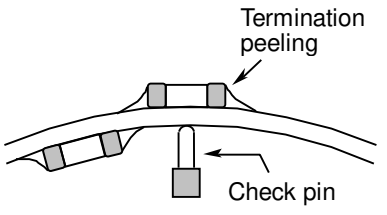
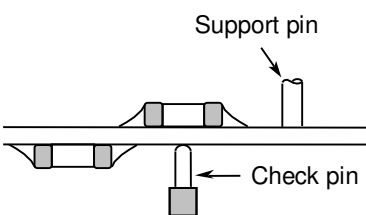
No.	Process	Condition																		
8	Handling after chip mounted  Caution	<p>(2) Example of a board cropping machine</p> <p>An outline of a printed circuit board cropping machine is shown below. The top and bottom blades are aligned with one another along the lines with the V-grooves on printed circuit board when cropping the board.</p> <p>Unrecommended example: Misalignment of blade position between top and bottom, right and left, or front and rear blades may cause a crack in the capacitor.</p> <div style="display: flex; justify-content: space-around;"> <div data-bbox="539 504 938 766"> <p>Outline of machine</p>  </div> <div data-bbox="941 504 1388 743"> <p>Principle of operation</p>  </div> </div> <div style="text-align: center; margin-top: 10px;"> <p>Cross-section diagram</p>  </div> <table border="1" style="width: 100%; margin-top: 10px; border-collapse: collapse;"> <thead> <tr> <th data-bbox="657 985 837 1070">Recommended</th> <th colspan="3" data-bbox="837 985 1369 1070">Unrecommended</th> </tr> <tr> <td></td> <th data-bbox="837 1070 1013 1115">Top-bottom misalignment</th> <th data-bbox="1013 1070 1189 1115">Left-right misalignment</th> <th data-bbox="1189 1070 1369 1115">Front-rear misalignment</th> </tr> </thead> <tbody> <tr> <td data-bbox="657 1115 837 1411"> <p>Top blade</p>  <p>Board</p> <p>Bottom blade</p> </td> <td data-bbox="837 1115 1013 1411"> <p>Top blade</p>  <p>Bottom blade</p> </td> <td data-bbox="1013 1115 1189 1411"> <p>Top blade</p>  <p>Bottom blade</p> </td> <td data-bbox="1189 1115 1369 1411"> <p>Top blade</p>  <p>Bottom blade</p> </td> </tr> </tbody> </table> <p>3) When functional check of the P.C.board is performed, check pin pressure tends to be adjusted higher for fear of loose contact. But if the pressure is excessive and bend the P.C.board, it may crack the chip capacitors or peel the terminations off. Please adjust the check pins not to bend the P.C.board.</p> <table border="1" style="width: 100%; margin-top: 10px; border-collapse: collapse;"> <thead> <tr> <th data-bbox="491 1657 630 1720">Item</th> <th data-bbox="630 1657 1050 1720">Not recommended</th> <th data-bbox="1050 1657 1449 1720">Recommended</th> </tr> </thead> <tbody> <tr> <td data-bbox="491 1720 630 1953">Board bending</td> <td data-bbox="630 1720 1050 1953">  <p>Termination peeling</p> <p>Check pin</p> </td> <td data-bbox="1050 1720 1449 1953">  <p>Support pin</p> <p>Check pin</p> </td> </tr> </tbody> </table>	Recommended	Unrecommended				Top-bottom misalignment	Left-right misalignment	Front-rear misalignment	<p>Top blade</p>  <p>Board</p> <p>Bottom blade</p>	<p>Top blade</p>  <p>Bottom blade</p>	<p>Top blade</p>  <p>Bottom blade</p>	<p>Top blade</p>  <p>Bottom blade</p>	Item	Not recommended	Recommended	Board bending	 <p>Termination peeling</p> <p>Check pin</p>	 <p>Support pin</p> <p>Check pin</p>
Recommended	Unrecommended																			
	Top-bottom misalignment	Left-right misalignment	Front-rear misalignment																	
<p>Top blade</p>  <p>Board</p> <p>Bottom blade</p>	<p>Top blade</p>  <p>Bottom blade</p>	<p>Top blade</p>  <p>Bottom blade</p>	<p>Top blade</p>  <p>Bottom blade</p>																	
Item	Not recommended	Recommended																		
Board bending	 <p>Termination peeling</p> <p>Check pin</p>	 <p>Support pin</p> <p>Check pin</p>																		

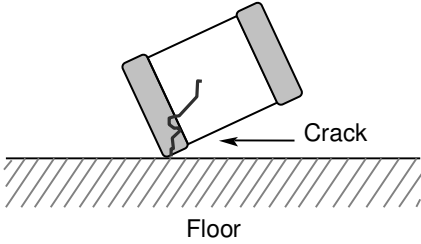
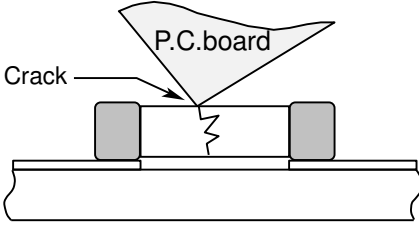

No.	Process	Condition
9	Handling of loose chip capacitors	<p>1) If dropped the chip capacitors may crack. Once dropped do not use it. Especially, the large case sized chip capacitors are tendency to have cracks easily, so please handle with care.</p>  <p>2) Piling the P.C.board after mounting for storage or handling, the corner of the P.C. board may hit the chip capacitors of another board to cause crack.</p> 
10	Capacitance aging	The capacitors (Class 2) have aging in the capacitance. They may not be used in precision time constant circuit. In case of the time constant circuit, the evaluation should be done well.
11	Estimated life and estimated failure rate of capacitors	<p>As per the estimated life and the estimated failure rate depend on the temperature and the voltage. This can be calculated by the equation described in JEITA RCR-2335C Annex F (Informative) Calculation of the estimated lifetime and the estimated failure rate ( Voltage acceleration coefficient : 3 multiplication rule, Temperature acceleration coefficient : 10°C rule)</p> <p>The failure rate can be decreased by reducing the temperature and the voltage but they will not be guaranteed.</p>

No.	Process	Condition
12	Caution during operation of equipment	<ol style="list-style-type: none"> <li>1) A capacitor shall not be touched directly with bare hands during operation in order to avoid electric shock. Electric energy held by the capacitor may be discharged through the human body when touched with a bare hand. Even when the equipment is off, a capacitor may stay charged. The capacitor should be handled after being completely discharged using a resistor.</li> <li>2) The terminals of a capacitor shall not be short-circuited by any accidental contact with a conductive object. A capacitor shall not be exposed to a conductive liquid such as an acid or alkali solution. A conductive object or liquid, such as acid and alkali, between the terminals may lead to the breakdown of a capacitor due to short circuit</li> <li>3) Confirm that the environment to which the equipment will be exposed during transportation and operation meets the specified conditions. Do not to use the equipment in the following environments. <ol style="list-style-type: none"> <li>(1) Environment where a capacitor is splattered with water or oil</li> <li>(2) Environment where a capacitor is exposed to direct sunlight</li> <li>(3) Environment where a capacitor is exposed to Ozone, ultraviolet rays or radiation</li> <li>(4) Environment where a capacitor exposed to corrosive gas(e.g. hydrogen sulfide, sulfur dioxide, chlorine. ammonia gas etc.)</li> <li>(5) Environment where a capacitor exposed to vibration or mechanical shock exceeding the specified limits.</li> <li>(6) Atmosphere change with causes condensation</li> </ol> </li> </ol>
13	Others  Caution	<p>The products listed on this specification sheet are intended for use in general electronic equipment (AV equipment, telecommunications equipment, home appliances, amusement equipment, computer equipment, personal equipment, office equipment, measurement equipment, industrial robots) under a normal operation and use condition.</p> <p>The products are not designed or warranted to meet the requirements of the applications listed below, whose performance and/or quality require a more stringent level of safety or reliability, or whose failure, malfunction or trouble could cause serious damage to society, person or property. Please understand that we are not responsible for any damage or liability caused by use of the products in any of the applications below or for any other use exceeding the range or conditions set forth in this specification sheet. If you intend to use the products in the applications listed below or if you have special requirements exceeding the range or conditions set forth in this specification, please contact us.</p> <ol style="list-style-type: none"> <li>(1) Aerospace/Aviation equipment</li> <li>(2) Transportation equipment (cars, electric trains, ships, etc.)</li> <li>(3) Medical equipment (Excepting Pharmaceutical Affairs Law classification Class1, 2)</li> <li>(4) Power-generation control equipment</li> <li>(5) Atomic energy-related equipment</li> <li>(6) Seabed equipment</li> <li>(7) Transportation control equipment</li> <li>(8) Public information-processing equipment</li> <li>(9) Military equipment</li> <li>(10) Electric heating apparatus, burning equipment</li> <li>(11) Disaster prevention/crime prevention equipment</li> <li>(12) Safety equipment</li> <li>(13) Other applications that are not considered general-purpose applications</li> </ol> <p>When designing your equipment even for general-purpose applications, you are kindly requested to take into consideration securing protection circuit/device or providing backup circuits in your equipment.</p>

## 11. TAPE PACKAGING SPECIFICATION

### 1. CONSTRUCTION AND DIMENSION OF TAPING

#### 1-1. Dimensions of carrier tape

Dimensions of paper tape shall be according to Appendix 3,4.

#### 1-2. Bulk part and leader of taping

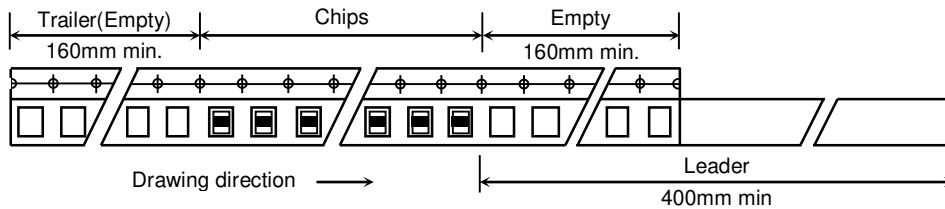

#### 1-3. Dimensions of reel

Dimensions of  $\varnothing 178$  reel shall be according to Appendix 5.

Dimensions of  $\varnothing 330$  reel shall be according to Appendix 6.

#### 1-4. Structure of taping

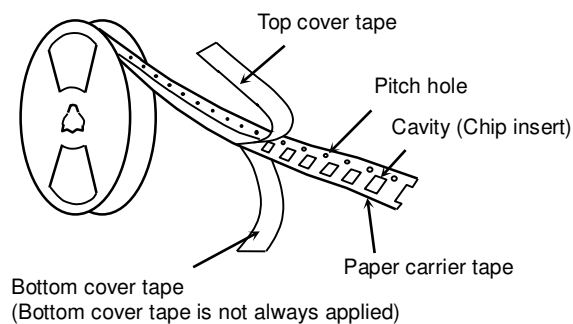

## 2. CHIP QUANTITY

Please refer to detail page on TDK Web.

### 3. PERFORMANCE SPECIFICATIONS

#### 3-1. Fixing peeling strength (top tape)

$$0.05\text{N} < \text{Peeling strength} < 0.7\text{N}$$

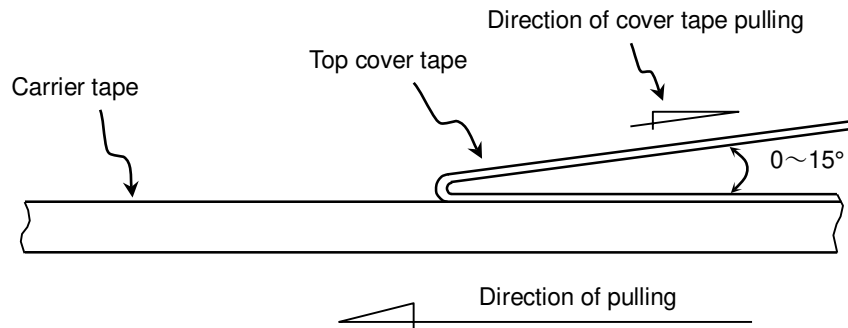

[ Paper tape should not adhere to top cover tape  
When pull the cover tape. ]

3-2. Carrier tape shall be flexible enough to be wound around a minimum radius of 30mm with components in tape.

3-3. The missing of components shall be less than 0.1%

3-4. Components shall not stick to fixing tape.

3-5. When removing the cover tape, there shall not be difficulties by unfitting clearance gap, burrs and crushes of cavities. Also the sprocket holes shall not be covered by absorbing dust into the suction nozzle.

### Appendix 3

#### Paper Tape

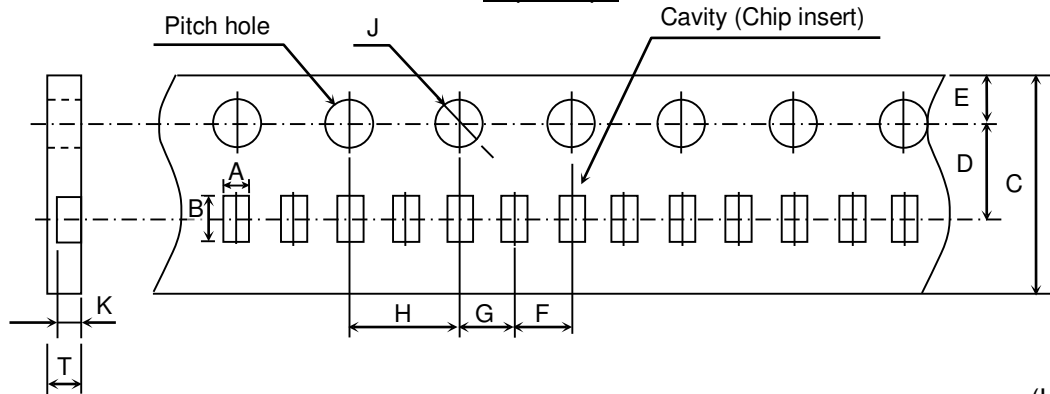

(Unit : mm)

Symbol	A	B	C	D	E	F
Case size						
CGB1 [CC0201]	( 0.38 )	( 0.68 )	8.00±0.30	3.50±0.05	1.75±0.10	2.00±0.05
CGB2 [CC0402]	( 0.62 )	( 1.12 )				

Symbol	G	H	J	K	T
Case size					
CGB1 [CC0201]	2.00±0.05	4.00±0.10	∅ 1.50 <sup>+0.10</sup> <sub>0</sub>	( 0.25 )	0.45 max.
CGB2 [CC0402]				( 0.38 ) [ 0.25 ]	0.75 max.

( ) Reference value.

As for CGB2T apply values in the brackets [ ].

### Appendix 4

#### Paper Tape

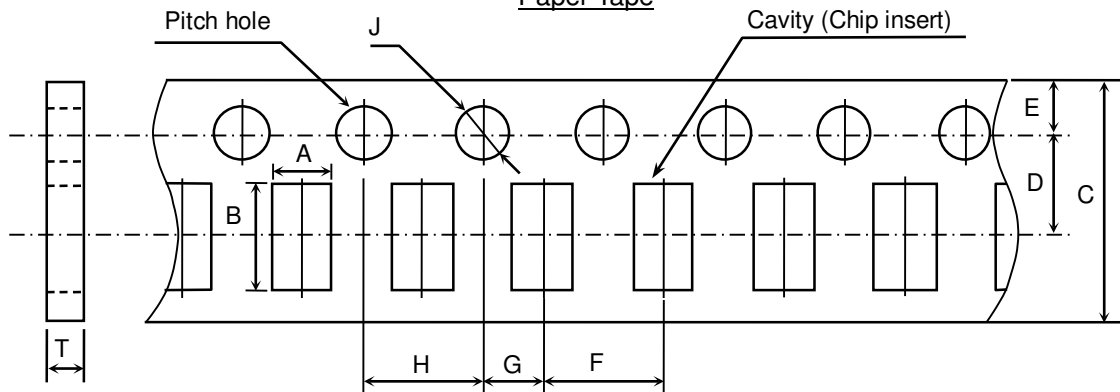

(Unit : mm)

Symbol	A	B	C	D	E	F
Case size						
CGB3 [CC0603]	( 1.10 )	( 1.90 )	8.00±0.30	3.50±0.05	1.75±0.10	4.00±0.10
CGB4 [CC0805]	( 1.50 )	( 2.30 )				

Symbol	G	H	J	T
Case size				
CGB3 [CC0603]	2.00±0.05	4.00±0.10	∅ 1.50 <sup>+0.10</sup> <sub>0</sub>	1.20 max.
CGB4 [CC0805]				

( ) Referenced value.

### Appendix 5

Dimensions of reel (Material : Polystyrene)

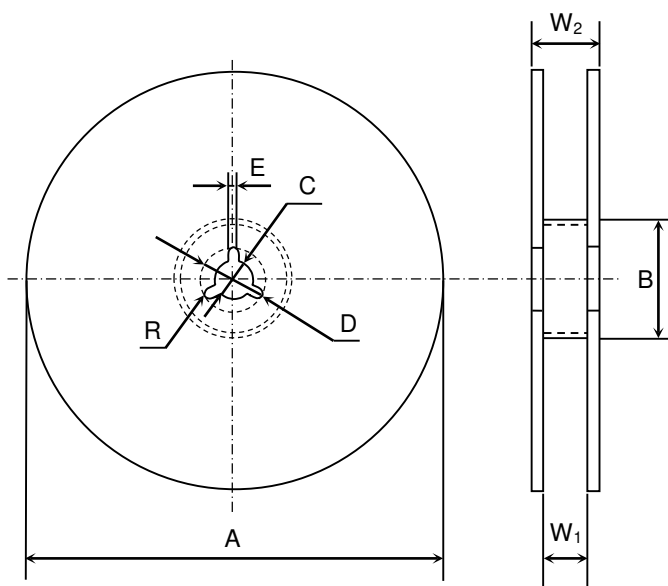

(Unit : mm)

Symbol	A	B	C	D	E	W <sub>1</sub>
Dimension	∅ 178±2.0	∅ 60±2.0	∅ 13±0.5	∅ 21±0.8	2.0±0.5	9.0±0.3
Symbol	W <sub>2</sub>	R				
Dimension	13.0±1.4	1.0				

### Appendix 6

Dimensions of reel (Material : Polystyrene)

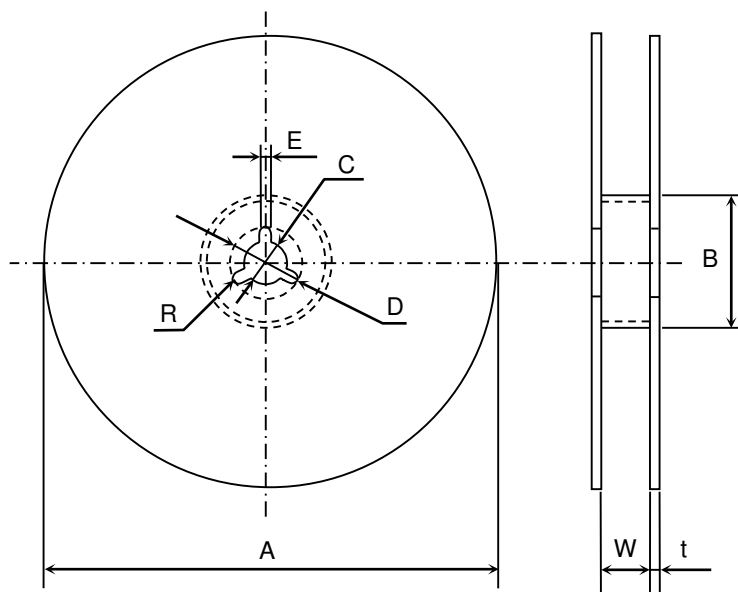

(Unit : mm)

Symbol	A	B	C	D	E	W
Dimension	∅ 382 max. (Nominal ∅ 330)	∅ 50 min.	∅ 13±0.5	∅ 21±0.8	2.0±0.5	10.0±1.5
Symbol	t	R				
Dimension	2.0±0.5	1.0				