

### FEATURES

**Full-featured evaluation board for the AD7799**

**Standalone USB interface**

**Various linking options**

**PC software for control of AD7799**

### GENERAL DESCRIPTION

This data sheet describes the evaluation board for the AD7799 low power, 24-bit  $\Sigma$ - $\Delta$  ADC. The AD7799 is a complete analog front end for low frequency measurement applications. It contains three differential inputs and includes a low noise instrumentation amplifier, a reference detect, and a low-side power switch.

Features include an update rate that can be varied from 4.17 Hz to 470 Hz, an on-board clock that eliminates the need for an external clock, and a  $\Sigma$ - $\Delta$  conversion technique that allows attainment of up to 24 bits of no missing codes performance.

The input signal is applied to an analog modulator, and the modulator output is processed by an on-chip digital filter. The

analog input channel of the AD7799 accepts analog input signals of  $\pm V_{REF}/\text{gain}$ , with a gain in the range of 1 to 128. When the gain is 64 and the update rate is programmed to 16.7 Hz, the rms noise is 65 nV. Simultaneous 50 Hz/60 Hz rejection is also available at this data update rate.

Full data on the AD7799 is available in the [AD7799](#) data sheet, available from Analog Devices, Inc., and should be consulted in conjunction with this document when using the evaluation board.

The evaluation board interfaces to the USB port of an IBM-compatible PC. Software is available with the evaluation board that allows the user to easily communicate with the AD7799.

The AD7799 evaluation board software should be installed before connecting the AD7799 evaluation board to the PC.

Other components on the AD7799 evaluation board include the [ADP3303](#), which is a high precision, low power, 3.3 V output voltage regulator used to power the USB/SPI interface.

### FUNCTIONAL BLOCK DIAGRAM

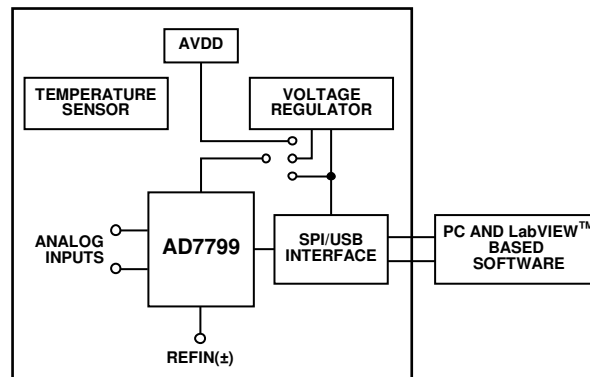

Figure 1.

#### Rev. 0

Evaluation boards are only intended for device evaluation and not for production purposes. Evaluation boards as supplied "as is" and without warranties of any kind, express, implied, or statutory including, but not limited to, any implied warranty of merchantability or fitness for a particular purpose. No license is granted by implication or otherwise under any patents or other intellectual property by application or use of evaluation boards. Information furnished by Analog Devices is believed to be accurate and reliable. However, no responsibility is assumed by Analog Devices for its use, nor for any infringements of patents or other rights of third parties that may result from its use. Analog Devices reserves the right to change devices or specifications at any time without notice. Trademarks and registered trademarks are the property of their respective owners. Evaluation boards are not authorized to be used in life support devices or systems.

## TABLE OF CONTENTS

Features .....	1	Installing the Software .....	5
General Description .....	1	Using the Software .....	5
Functional Block Diagram .....	1	Main Window .....	6
Revision History .....	2	Registers Window .....	8
Evaluation Board Hardware.....	3	Other Registers Window .....	9
Power Supplies .....	3	Temp Demo Window .....	10
Links .....	3	Evaluation Board Schematic and Artwork.....	11
Sockets .....	3	Ordering Information.....	15
Setting Up the Evaluation Board.....	3	Bill of Materials.....	15
Interfacing to the Evaluation Board.....	4	Ordering Guide .....	15
Evaluation Board Software.....	5	ESD Caution.....	15
Software Description.....	5		

## REVISION HISTORY

4/08—Revision 0: Initial Version

## EVALUATION BOARD HARDWARE

### POWER SUPPLIES

The evaluation board is powered via the 5 V supply from the USB connector, J1. This 5 V supply can be used to power the AD7799 directly or a 3.3 V regulated voltage from the on-board ADP3303 high precision, low power, 3.3 V output voltage regulator can be used to power the AD7799. Alternatively, the AD7799 can be powered using an external 3 V or 5 V power supply via J3.

### LINKS

There are 10 link options that must be set for the required operating setup before using the evaluation board. The functions of these link options are outlined in Table 1.

**Table 1. Evaluation Board Link Settings**

Link No.	Default	Description
LK1, LK2	In	These links are used to connect the AIN1(+) and AIN1(−) inputs to a reference voltage that equals $AV_{DD}/2$ . With this configuration, a noise analysis can be performed. With these links removed, an external voltage can be applied to AIN1(+)/AIN1(−) using the SMB connectors.
LK3 to LK6	Out	These links are used to connect the on-board temperature demonstration circuit to the ADC; all must be in place when attempting to measure ambient temperature. When LK3 and LK4 are inserted, the 1 k $\Omega$ thermistor is connected to AIN2(+)/AIN2(−). With LK5 and LK6 in place, a 5 k $\Omega$ precision resistor is used to generate the reference. This results in a ratiometric configuration.
LK7, LK8	In	A resistor-divider network generates a voltage equal to $AV_{DD}/2$ , which can be used as the reference for the AD7799. With LK7 and LK8 in place, $AV_{DD}/2$ is connected to REFIN(+) and REFIN(−) is connected to GND. To use another reference source, remove LK7 and LK8.
LK9	B	LK9 is used to select the power source for $AV_{DD}$ on the AD7799. LK9 in Position A selects an external power supply, supplied via J3. LK9 in Position B selects the 3.3 V regulated output from the on-board ADP3303 voltage regulator. LK9 in Position C selects the 5 V supply from the USB connector, J1.
LK10	In	LK10 is used to test the on-chip low-side power switch. If LK10 is in place, enabling the low-side power switch using <b>PWR SW</b> in the <b>Registers</b> window turns on the LED, D2. Clearing this bit turns off the LED.

**Table 2. Initial Link and Switch Positions**

Link No.	Position	Description
LK1, LK2	In	AIN1(+) and AIN1(−) are shorted to the reference voltage.
LK3 to LK6	Out	The demonstration circuit is disconnected from the AD7799.
LK7, LK8	In	The reference voltage is set to 1.65 V (3.3 V/2).
LK9	B	The 3.3 V supply is used as $AV_{DD}$ for the AD7799.
LK10	In	The D2 LED is connected to the low-side power switch of the AD7799.

**Table 3. Socket Functions**

Socket	Description
AIN1(+)	Subminiature BNC (SMB) connector. The analog input signal for the AIN1(+) input of the AD7799 is applied to this socket.
AIN1(−)	Subminiature BNC (SMB) connector. The analog input signal for the AIN1(−) input of the AD7799 is applied to this socket.
REFIN(+)	Subminiature BNC (SMB) connector. This socket is used in conjunction with REFIN(−) to apply an external reference to the AD7799. The voltage for the REFIN(+) input of the AD7799 is applied to this socket.
REFIN(−)	Subminiature BNC (SMB) connector. This socket is used in conjunction with REFIN(+) to apply an external reference to the AD7799. The voltage for the REFIN(−) input of the AD7799 is applied to this socket.
J2	18-pin (2 × 9) straight header. This socket is used in conjunction with the prototype area to interface any signal to the AD7799.

### SOCKETS

There are five sockets relevant to the operation of the AD7799 on this evaluation board. The functions of these sockets are described in Table 3.

### SETTING UP THE EVALUATION BOARD

Care should be taken before applying power and signals to the evaluation board to ensure that all link positions are as per the required operating mode. Table 2 shows the position in which the links are set when the evaluation board is shipped.

## INTERFACING TO THE EVALUATION BOARD

Interfacing to the evaluation board is via a standard USB connector, J1. J1 is used to connect the evaluation board to the USB port of a PC. A standard USB connector cable is included with the AD7799 evaluation board to allow the evaluation board to interface with the USB port of the PC. Because the board is powered via the USB connector, there is no need for an external power supply, although one can be connected via J3 if preferred.

Communication between the AD7799 and the PC is via the USB/SPI interface. The on-board USB controller (U2) controls this communication.

To set up the USB/SPI interface, use the following procedure:

1. Install the AD7799 evaluation board software using the supplied AD7799 evaluation board CD-ROM before connecting the board to the PC.
2. After the AD7799 evaluation board software has been installed, connect the board to the PC via J1 on the AD7799 evaluation board and via the USB port on the PC using the supplied USB connector cable. The PC automatically finds the new USB device and identifies it as the AD7799 evaluation board.
3. Follow the on-screen instructions that appear automatically. If the **Hardware Installation** window shown in Figure 2 appears during the installation process, click **Continue Anyway** to successfully complete the installation of the AD7799 evaluation board.

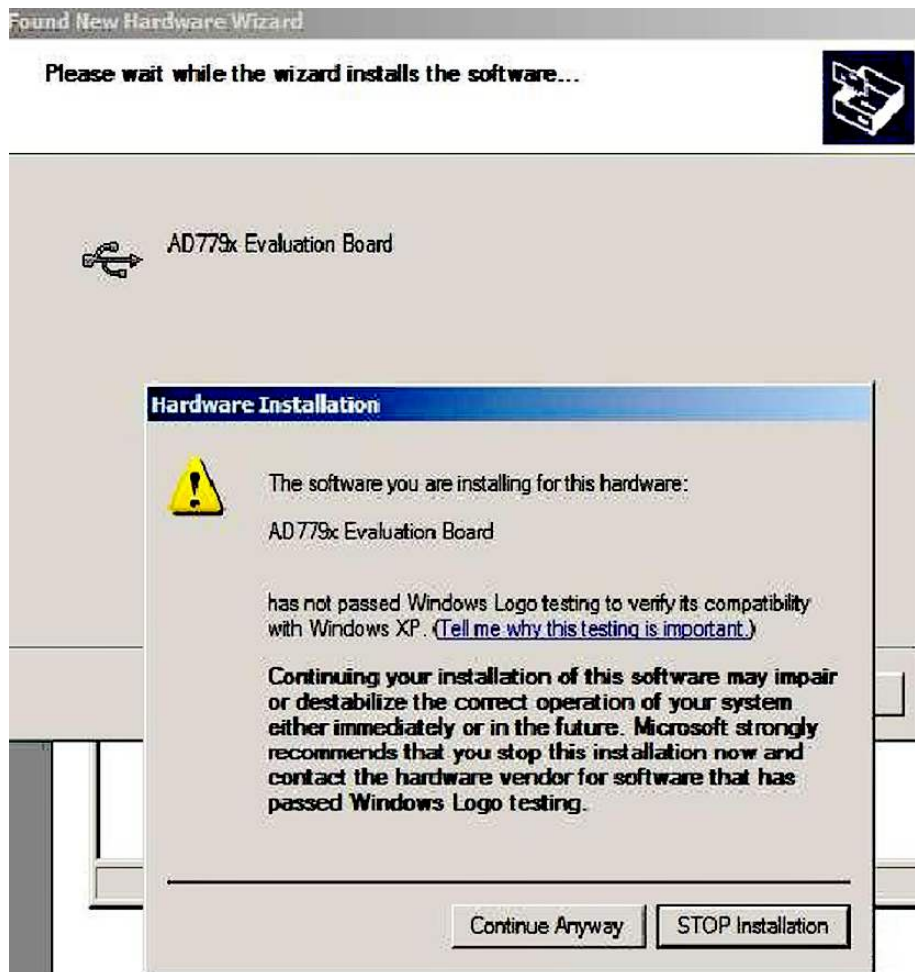

Figure 2. Hardware Installation Window

07431-002

## EVALUATION BOARD SOFTWARE

### SOFTWARE DESCRIPTION

The AD7799 evaluation board is shipped with a CD-ROM containing software that can be installed onto a standard PC to control the AD7799. The software uses the USB of the PC to communicate with the AD7799 via the cable provided with the board.

The software allows the user to configure the AD7799 and to read conversion data from the AD7799.

Data can be read from the AD7799 and displayed or stored for later analysis. For further information, see the [AD7799](#) data sheet.

### INSTALLING THE SOFTWARE

Use the following procedure to install the software:

1. Start Windows® and insert the CD-ROM.
2. The installation software should launch automatically. If it does not, use Windows Internet Explorer to locate the file **setup.exe** on the CD-ROM. Double-clicking on this file starts the installation procedure.
3. At the prompt, select a destination directory, which is **C:\Program Files\Analog Devices\AD7799** by default.

After the directory is selected, the installation procedure copies the files into the relevant directories on the hard drive. The installation program creates a program group called **Analog Devices** with the subgroup **AD7799** in the **Start** menu of the taskbar.

4. Once the installation procedure is complete, double-click the **AD7799** icon to start the program.

### USING THE SOFTWARE

Figure 3 shows the main window that is displayed when the program starts. The Main Window section briefly describes the menus on the main window. Following the Main Window section are descriptions of the most commonly used evaluation software windows.

The data that has been read can be exported to other packages, such as MathCAD™ or Microsoft® Excel, for further analysis.

On power-up, the AD7799 evaluation board software configures the device to have a gain of 64, the reference pins are connected to  $AV_{DD}/2$ , the  $AIN1(-)/AIN1(-)$  channel is selected,  $AIN1(-)$  is connected to  $AV_{DD}/2$ , and the update rate is set to 16.7 Hz.

# EVAL-AD7799

## MAIN WINDOW

### Menu Bar

#### File

Allows the user to read previously stored data for display or analysis, write the current set of data to a file for later use, and exit the program.

#### About

Provides information on the revision of software being used.

### Buttons

#### Reset

Allows the user to reset the AD7799 and set the registers to the power-up conditions as specified by the software (channel = AIN1(-)/AIN1(-), gain = 64, update rate = 16.7 Hz).

#### Exit

Allows the user to exit the software. Serves the same purpose as **Quit** in the **File** drop-down menu.

#### Sample

Allows the user to read a number of samples from the AD7799. Noise analysis is then performed on the samples. These samples can be stored for further analysis. The sample size is entered in the **Num Samples** box.

#### Continuous

Allows the user to read a number of samples continuously. The software gathers the number of samples specified by **Num Samples**, performs noise analysis on the samples, and then gathers the next group of samples.

#### Registers

Allows the user to access the configuration register, mode register, and IO register.

#### Other Registers

Allows the user to access the ID register, status register, offset register, and full-scale register.

#### Quick Analysis

Selects the **Quick Analysis** window. The **Quick Analysis** window provides the user with access to the following subset of AD7799 control bits: **Channel**, **Update Rate**, and **Gain**. For access to all control bits, click **Registers** or **Other Registers**.

#### Temp Demo

Allows the user to access the temperature demonstration software.

#### Num Samples

The number of samples to gather for analysis is entered in this box.

#### Get Samples

Serves the same purpose as the **Sample** button.

#### Waveform

The gathered conversions are displayed in graph form.

#### Histogram

The gathered samples are used to generate a histogram

#### Codes

The gathered samples can be displayed as codes or in voltage format. When **Codes** is clicked, the values are displayed as codes, and the **Codes** button changes to **Volts**. To display the information as volts, click **Volts**.

#### External Reference

The value of the external reference applied to the AD7799 should be entered in the **External Reference** box. The default value is 1.65 V.

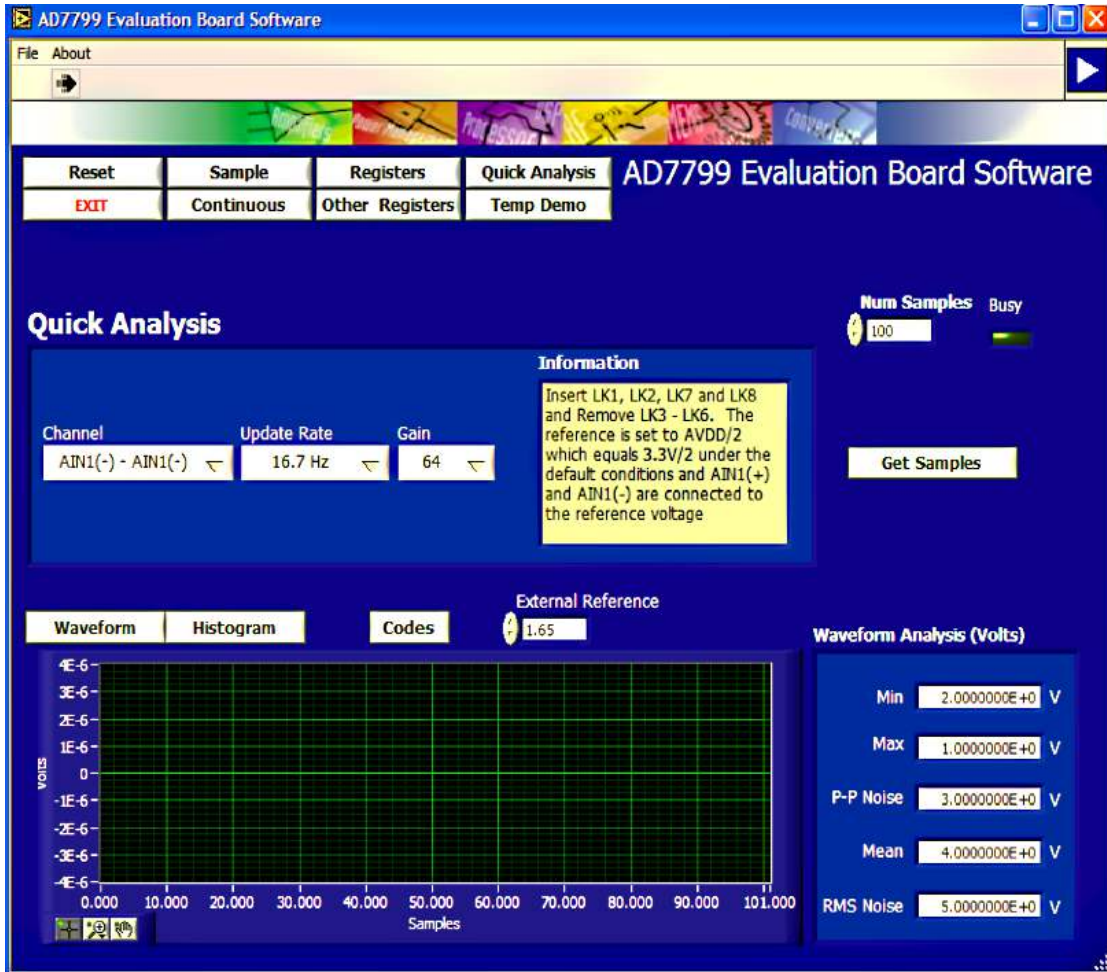

Figure 3. AD7799 Evaluation Software Main Window

07431-003

# EVAL-AD7799

## REGISTERS WINDOW

This window is accessed by clicking **Registers**, which allows access to the configuration register, mode register, and IO register. Figure 4 shows the **Registers** window. This window

allows the customer to change the update rate, gain, low-side power switch, and so on. Consult the [AD7799](#) data sheet for further details on the bit functions.

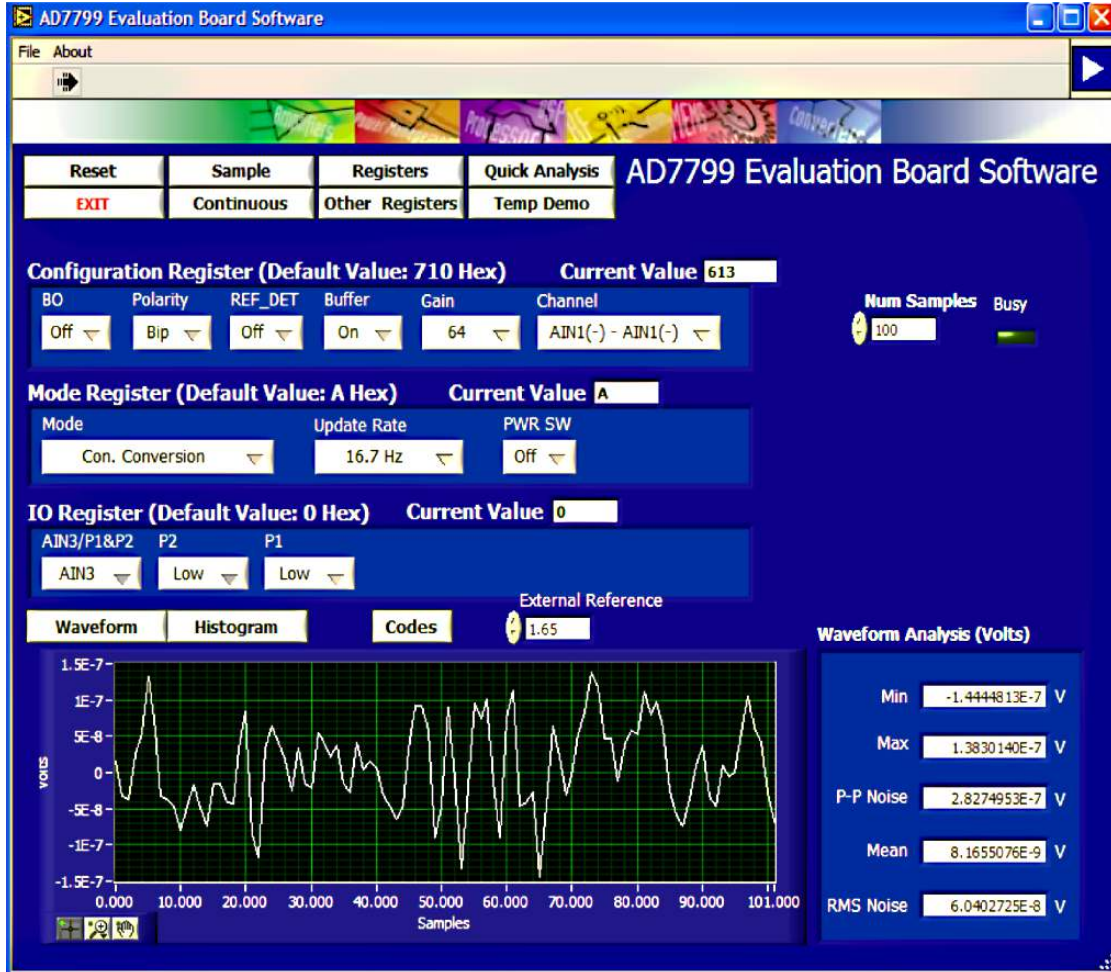

Figure 4. AD7799 Evaluation Software Registers Window



**OTHER REGISTERS WINDOW**

This window is accessed by clicking **Other Registers** (see Figure 5). It displays the contents of the offset calibration register, ID register, full-scale calibration register, and status register. To write to the offset and full-scale calibration

registers, the user must place the AD7799 in power-down or idle mode using the **Mode** box in the **Registers** window (see Figure 4).

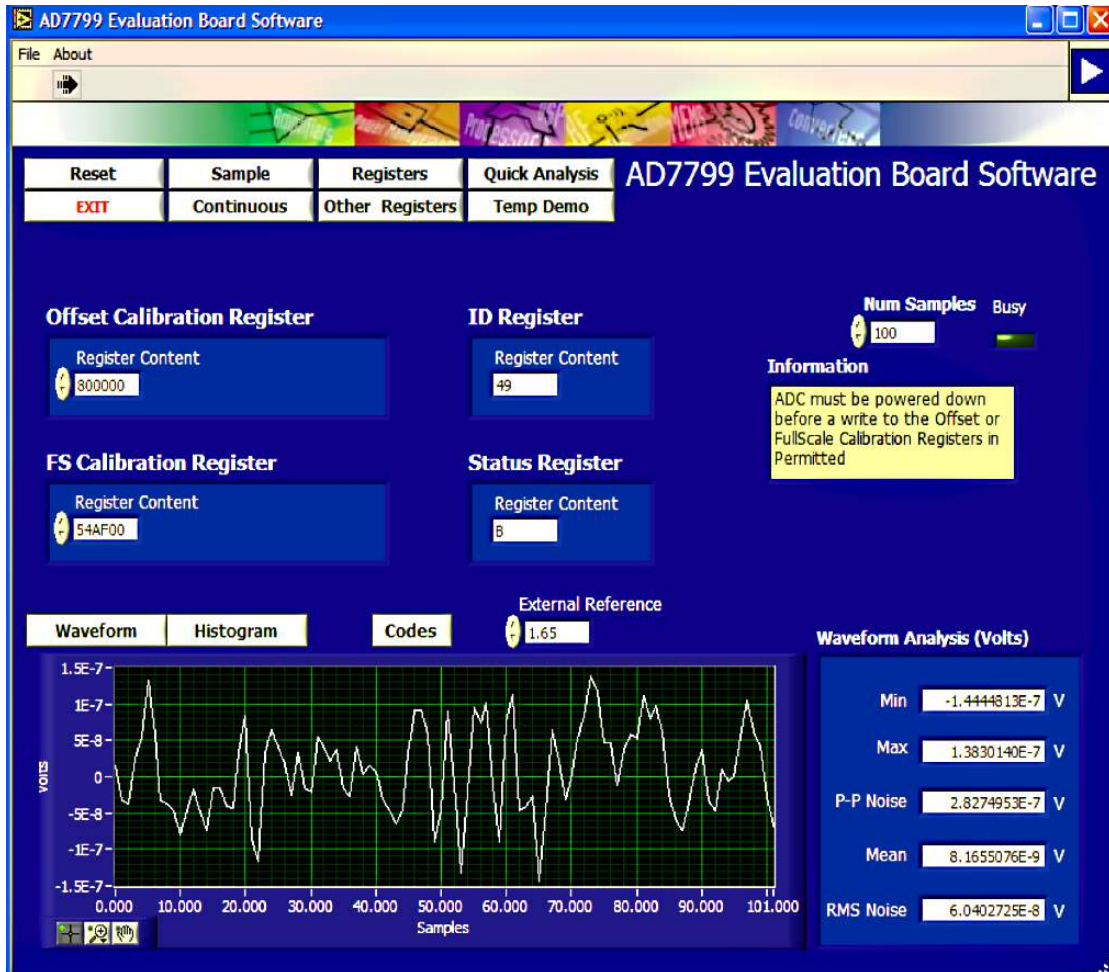

Figure 5. AD7799 Evaluation Software Other Registers Window

# EVAL-AD7799

## TEMP DEMO WINDOW

This window is accessed by clicking **Temp Demo**. The AD7799 evaluation board has a temperature demonstration included on board. To operate the temperature demonstration, LK3 to LK6 should be inserted and LK1, LK2, LK7, LK8, and LK10 should be removed. With this configuration, a 1 k $\Omega$  thermistor is connected to the AIN2(+)/AIN2(-) channel. In series with the thermistor is a 5 k $\Omega$  precision resistor, which is connected to the AD7799 reference pins. The thermistor and precision resistor are connected to AV<sub>DD</sub> in a ratiometric configuration.

The temperature demonstration software saves the values in the mode register, configuration register, and IO register and then configures the AD7799 to operate with the AIN2(+)/AIN2(-) channel. The gain is set to 1, and the reference voltage is adjusted appropriately. The software continuously reads the conversion from the AIN2(+)/AIN2(-) channel and converts the result to temperature using a look-up table.

To exit the temperature demonstration, click **Back**. The software sets the configuration register, mode register, and IO register to their pretemperature demonstration values.

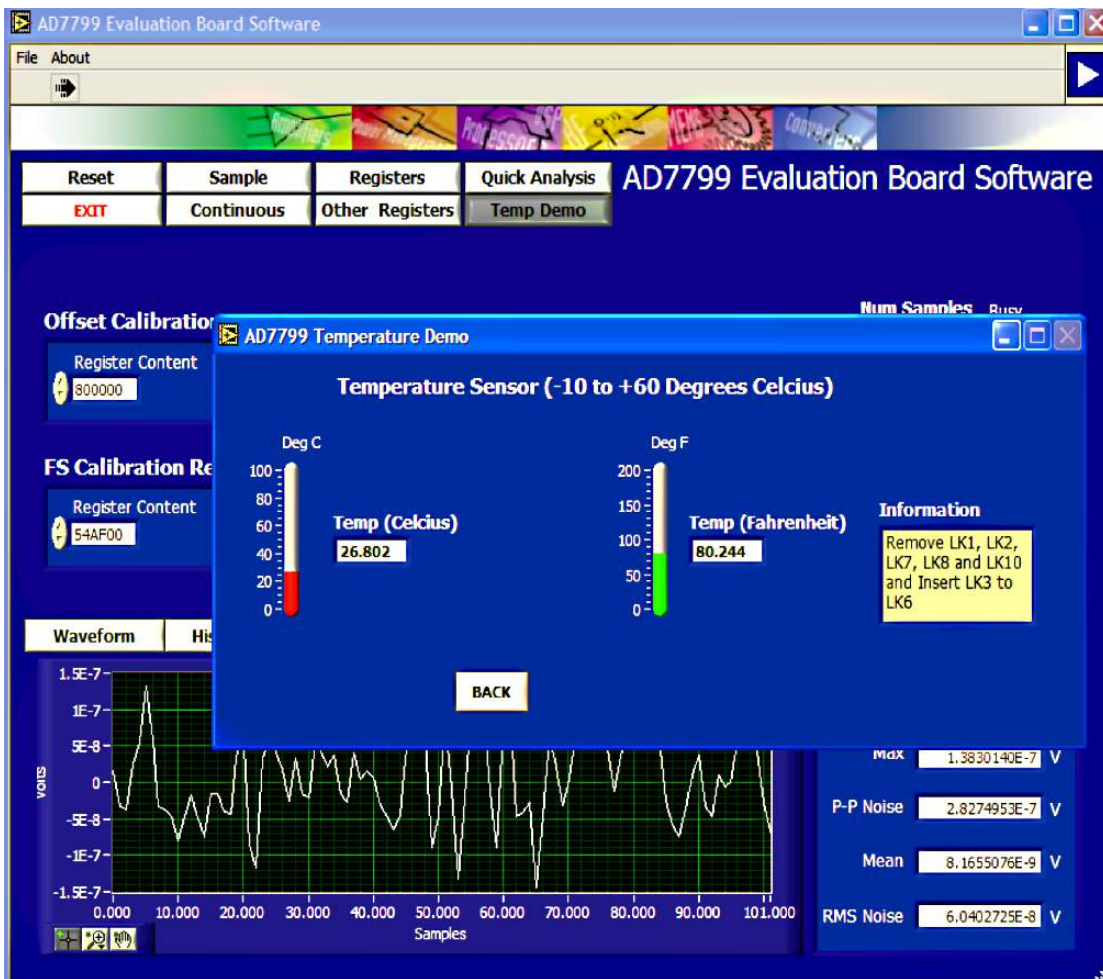

Figure 6. AD7799 Evaluation Software Temperature Demo Window

EVALUATION BOARD SCHEMATIC AND ARTWORK

07431-007

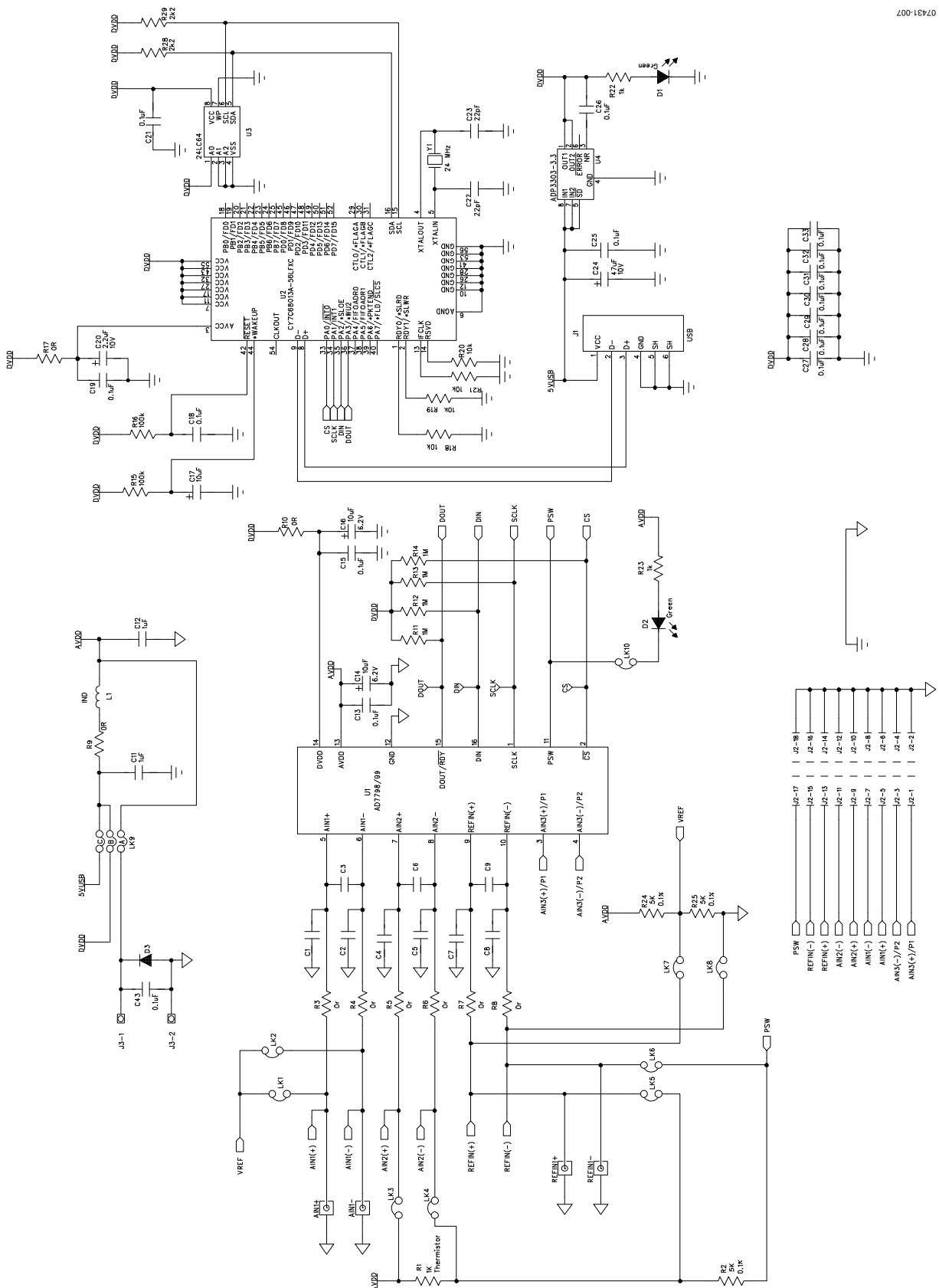

Figure 7. AD7799 Evaluation Board Schematic

# EVAL-AD7799

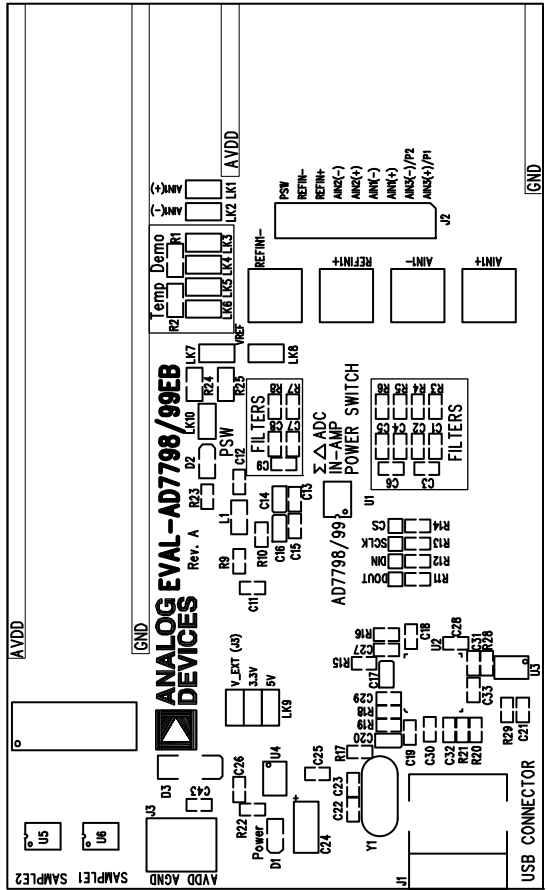

Figure 8. AD7799 Evaluation Board—Component Layout Diagram

074531-008

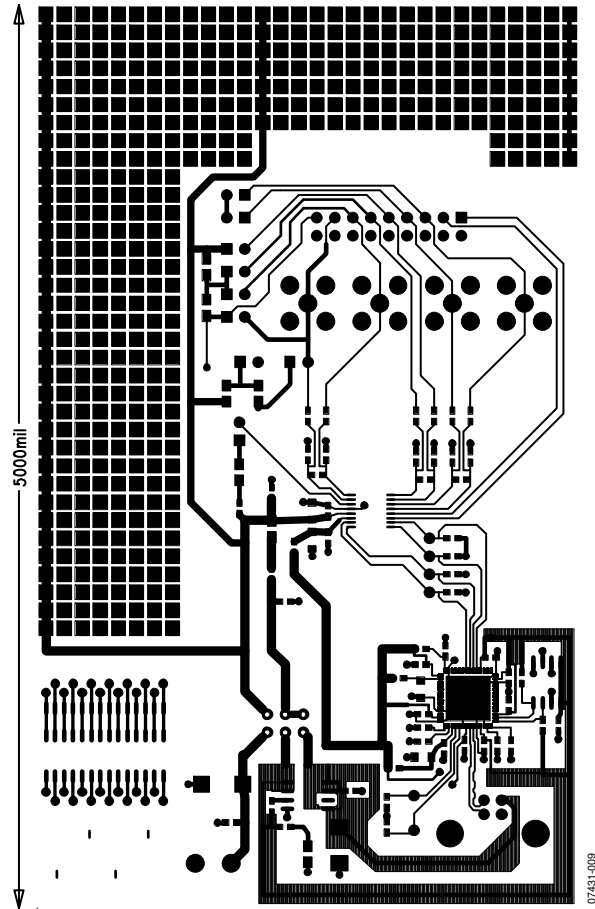

Figure 9. AD7799 Evaluation Board—Component Side Artwork

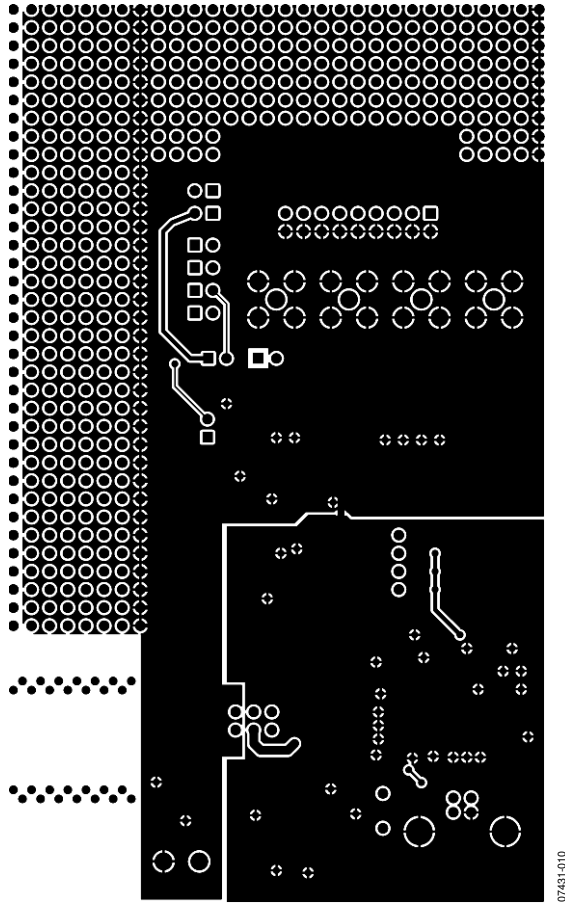

Figure 10. AD7799 Evaluation Board—Solder Side Artwork

## ORDERING INFORMATION

### BILL OF MATERIALS

Table 4.

Qty	Reference Designator	Description	Manufacturer/Part No.
	Integrated Circuits		
3	U1, U5, U6	AD7799BRUZ	Analog Devices
1	U2	USB Controller	Cypress Semiconductor Corporation, CY7C68013A-56LFXC
1	U3	24LC64	Microchip Technology Inc., 24LC64-I/SN
1	U4	ADP3303ARZ-3.3	Analog Devices
1	Y1	24 MHz Crystal	AEL Crystals, X24M000000S244
2	D1, D2	Green LED	Fairchild Semiconductor, QTLF630C-4
1	L1	Ferrite Bead	Meggitt Sigma, BMB2A0300AN1
1	D3	Diode	Micro Commercial Components Corp., DL4001-TP
	Capacitors		
9	C1 to C9		Not inserted
2	C11, C12	1 $\mu$ F Ceramic	Yageo Corporation, 223824619863
15	C13, C15, C18, C19, C21, C25 to C33, C43	0.1 $\mu$ F $\pm$ 10% Ceramic	AVX Corporation, CM105X7R104K16AT
3	C14, C16, C17	10 $\mu$ F Tantalum	AVX Corporation, TAJA106K010R
1	C20	2.2 $\mu$ F Tantalum	EPCOS AG, B45196E2225K109
2	C22, C23	22 pF Ceramic	Yageo Corporation, 223886715229
1	C24	47 $\mu$ F Tantalum	AVX Corporation, TAJC476K016R
	Resistors		
1	R1	1 k $\Omega$ Thermistor	EPCOS AG, B57620C102J62
3	R2, R24, R25	5 k $\Omega$ $\pm$ 0.1%	Tyco International, Ltd., RN73C2A4K99BTG
9	R3 to R10, R17	0 $\Omega$ Resistor	Multicomp, MC 0.063W 0603 0R
4	R11 to R14	1 M $\Omega$ Resistor	Multicomp, MC 0.063W 0603 1% 1M
2	R15, R16	100 k $\Omega$ Resistor	Multicomp, MC 0.063W 0603 1% 100K
4	R18 to R21	10 k $\Omega$ Resistor	Multicomp, MC 0.063W 0603 1% 10K
2	R22, R23	1 k $\Omega$ Resistor	Multicomp, MC 0.063W 0603 1% 1K
2	R28, R29	2.2 k $\Omega$ Resistor	Multicomp, MC 0.063W 0603 1% 2K2
	Links		
10	LK1 to LK8, LK10 (2 $\times$ 1 way), LK9 (3 $\times$ 2 way)	Pin Headers	Harwin Plc, M20-9983646
10	At LK1 to LK10	Shorting Plugs	Harwin Plc, M7566-05
	Connectors		
4	AIN1+, AIN1-, REFIN1+, REFIN1-	SMB Connector	Not inserted
1	J1	USB Mini-B Connector	Molex, 565790576
1	J2	18-Pin (2 $\times$ 9) Header	Harwin Plc, M20-9983646
1	J3	Two-Way Terminal Block	Camden Electronics Ltd., CTB5000/2

### ORDERING GUIDE

Model	Description
EVAL-AD7799EBZ <sup>1</sup>	Evaluation Board

<sup>1</sup> Z = RoHS Compliant Part.

### ESD CAUTION



**ESD (electrostatic discharge) sensitive device.**  
Charged devices and circuit boards can discharge without detection. Although this product features patented or proprietary protection circuitry, damage may occur on devices subjected to high energy ESD. Therefore, proper ESD precautions should be taken to avoid performance degradation or loss of functionality.

**EVAL-AD7799**

**NOTES**