

# Product data sheet

Specifications



variable speed drive, Altivar 212,  
75kW, 100hp, 480V, 3 phases, with  
EMC, IP21

ATV212HD75N4

## Main

Device short name	ATV212
Product destination	Asynchronous motors
Network number of phases	3 phases
Motor power kW	75 kW
Motor power hp	100 hp
Supply voltage limits	323...528 V
Supply frequency	50...60 Hz - 5...5 %
Line current	141.8 A at 380 V 111.3 A at 480 V
Range of product	Altivar 212
Product or component type	Variable speed drive
Product specific application	Pumps and fans in HVAC
Communication port protocol	METASYS N2 Modbus APOGEE FLN BACnet LonWorks
[Us] rated supply voltage	380...480 V - 15...10 %
EMC filter	Class C2 EMC filter integrated
IP degree of protection	IP21

## Complementary

Apparent power	105.3 kVA at 380 V
Continuous output current	160 A at 380 V 160 A at 460 V
Maximum transient current	176 A for 60 s
Speed drive output frequency	0.5...200 Hz
Speed range	1...10
Speed accuracy	+/- 10 % of nominal slip 0.2 Tn to Tn
Local signalling	1 LED (red) for DC bus energized
Output voltage	<= power supply voltage
Isolation	Electrical between power and control
Type of cable	Without mounting kit: 1 wire(s)IEC cable at 45 °C, copper 90 °C / XLPE/EPR

Without mounting kit: 1 wire(s)IEC cable at 45 °C, copper 70 °C / PVC  
 With UL Type 1 kit: 3 wire(s)UL 508 cable at 40 °C, copper 75 °C / PVC

<b>Electrical connection</b>	VIA, VIB, FM, FLA, FLB, FLC, RY, RC, F, R, RES: terminal 2.5 mm <sup>2</sup> / AWG 14 L1/R, L2/S, L3/T: terminal 150 mm <sup>2</sup> (300 kcmil)
<b>Tightening torque</b>	0.6 N.m (VIA, VIB, FM, FLA, FLB, FLC, RY, RC, F, R, RES) 41 N.m, 360 lb.in (L1/R, L2/S, L3/T)
<b>Supply</b>	Internal supply for reference potentiometer (1 to 10 kOhm): 10.5 V DC +/- 5 %, <10 A, protection type: overload and short-circuit protection Internal supply: 24 V DC (21...27 V), <200 A, protection type: overload and short-circuit protection
<b>Sampling duration</b>	2 ms +/- 0.5 ms F discrete 2 ms +/- 0.5 ms R discrete 2 ms +/- 0.5 ms RES discrete 3.5 ms +/- 0.5 ms VIA analog 22 ms +/- 0.5 ms VIB analog
<b>Response time</b>	FM 2 ms, tolerance +/- 0.5 ms for analog output(s) FLA, FLC 7 ms, tolerance +/- 0.5 ms for discrete output(s) FLB, FLC 7 ms, tolerance +/- 0.5 ms for discrete output(s) RY, RC 7 ms, tolerance +/- 0.5 ms for discrete output(s)
<b>Accuracy</b>	+/- 0.6 % (VIA) for a temperature variation 60 °C +/- 0.6 % (VIB) for a temperature variation 60 °C +/- 1 % (FM) for a temperature variation 60 °C
<b>Linearity error</b>	VIA: +/- 0.15 % of maximum value for input VIB: +/- 0.15 % of maximum value for input FM: +/- 0.2 % for output
<b>Analogue output type</b>	FM switch-configurable voltage 0...10 V DC, impedance: 7620 Ohm, resolution 10 bits FM switch-configurable current 0...20 mA, impedance: 970 Ohm, resolution 10 bits
<b>Discrete output type</b>	Configurable relay logic: (FLA, FLC) NO - 100000 cycles Configurable relay logic: (FLB, FLC) NC - 100000 cycles Configurable relay logic: (RY, RC) NO - 100000 cycles
<b>Minimum switching current</b>	3 mA at 24 V DC for configurable relay logic
<b>Maximum switching current</b>	5 A at 250 V AC on resistive load - cos phi = 1 - L/R = 0 ms (FL, R) 5 A at 30 V DC on resistive load - cos phi = 1 - L/R = 0 ms (FL, R) 2 A at 250 V AC on inductive load - cos phi = 0.4 - L/R = 7 ms (FL, R) 2 A at 30 V DC on inductive load - cos phi = 0.4 - L/R = 7 ms (FL, R)
<b>Discrete input type</b>	F programmable 24 V DC, with level 1 PLC, impedance: 4700 Ohm R programmable 24 V DC, with level 1 PLC, impedance: 4700 Ohm RES programmable 24 V DC, with level 1 PLC, impedance: 4700 Ohm
<b>Discrete input logic</b>	Positive logic (source) (F, R, RES), <= 5 V (state 0), >= 11 V (state 1) Negative logic (sink) (F, R, RES), >= 16 V (state 0), <= 10 V (state 1)
<b>Dielectric strength</b>	3535 V DC between earth and power terminals 5092 V DC between control and power terminals
<b>Insulation resistance</b>	>= 1 mOhm 500 V DC for 1 minute
<b>Frequency resolution</b>	Display unit: 0.1 Hz Analog input: 0.024/50 Hz
<b>Communication service</b>	Read device identification (43) Write single register (06) Time out setting from 0.1 to 100 s Monitoring inhibitible Read holding registers (03) 2 words maximum Write multiple registers (16) 2 words maximum
<b>Option card</b>	Communication card for LonWorks
<b>Power dissipation in W</b>	1945 W
<b>Air flow</b>	666 m3/h
<b>Functionality</b>	Mid
<b>Specific application</b>	HVAC
<b>Variable speed drive application selection</b>	Building - HVAC compressor for scroll Building - HVAC fan Building - HVAC pump
<b>Motor power range AC-3</b>	55...100 kW at 380...440 V 3 phases 55...100 kW at 480...500 V 3 phases
<b>Motor starter type</b>	Variable speed drive
<b>Discrete output number</b>	2
<b>Analogue input number</b>	2

<b>Analogue input type</b>	VIA switch-configurable voltage: 0...10 V DC 24 V max, impedance: 30000 Ohm, resolution 10 bits VIB configurable voltage: 0...10 V DC 24 V max, impedance: 30000 Ohm, resolution 10 bits VIB configurable PTC probe: 0...6 probes, impedance: 1500 Ohm VIA switch-configurable current: 0...20 mA, impedance: 250 Ohm, resolution 10 bits
<b>Analogue output number</b>	1
<b>Physical interface</b>	2-wire RS 485
<b>Connector type</b>	1 open style 1 RJ45
<b>Transmission rate</b>	9600 bps or 19200 bps
<b>Transmission frame</b>	RTU
<b>Number of addresses</b>	1...247
<b>Data format</b>	8 bits, 1 stop, odd even or no configurable parity
<b>Type of polarization</b>	No impedance
<b>Asynchronous motor control profile</b>	Voltage/frequency ratio, 5 points Voltage/frequency ratio - Energy Saving, quadratic U/f Voltage/frequency ratio, automatic IR compensation (U/f + automatic U <sub>0</sub> ) Voltage/frequency ratio, 2 points Flux vector control without sensor, standard
<b>Torque accuracy</b>	+/- 15 %
<b>Transient overtorque</b>	120 % of nominal motor torque +/- 10 % for 60 s
<b>Acceleration and deceleration ramps</b>	Automatic based on the load Linear adjustable separately from 0.01 to 3200 s
<b>Motor slip compensation</b>	Not available in voltage/frequency ratio motor control Automatic whatever the load Adjustable
<b>Switching frequency</b>	6...16 kHz adjustable 8...16 kHz with derating factor
<b>Nominal switching frequency</b>	8 kHz
<b>Braking to standstill</b>	By DC injection
<b>Network frequency</b>	47.5...63 Hz
<b>Prospective line I<sub>sc</sub></b>	22 kA
<b>Protection type</b>	Overheating protection: drive Thermal power stage: drive Short-circuit between motor phases: drive Input phase breaks: drive Overcurrent between output phases and earth: drive Overvoltages on the DC bus: drive Break on the control circuit: drive Against exceeding limit speed: drive Line supply overvoltage and undervoltage: drive Line supply undervoltage: drive Against input phase loss: drive Thermal protection: motor Motor phase break: motor With PTC probes: motor
<b>Width</b>	320 mm
<b>Height</b>	630 mm
<b>Depth</b>	290 mm
<b>Environment</b>	
<b>Pollution degree</b>	3 conforming to IEC 61800-5-1  IP20 on upper part without blanking plate on cover conforming to EN/IEC 61800-5-1 IP20 on upper part without blanking plate on cover conforming to EN/IEC 60529 IP21 conforming to EN/IEC 61800-5-1 IP21 conforming to EN/IEC 60529 IP41 on upper part conforming to EN/IEC 61800-5-1 IP41 on upper part conforming to EN/IEC 60529
<b>Vibration resistance</b>	1.5 mm (f= 3...13 Hz) conforming to EN/IEC 60068-2-6 1 gn (f= 13...200 Hz) conforming to EN/IEC 60068-2-8
<b>Shock resistance</b>	15 gn for 11 ms conforming to IEC 60068-2-27

<b>Environmental characteristic</b>	Classes 3C1 conforming to IEC 60721-3-3 Classes 3S2 conforming to IEC 60721-3-3
<b>Noise level</b>	63.7 dB conforming to 86/188/EEC
<b>Operating altitude</b>	1000...3000 m limited to 2000 m for the Corner Grounded distribution network with current derating 1 % per 100 m <= 1000 m without derating
<b>Relative humidity</b>	5...95 % without condensation conforming to IEC 60068-2-3 5...95 % without dripping water conforming to IEC 60068-2-3
<b>Ambient air temperature for operation</b>	-10...40 °C (without derating) 40...50 °C (with derating factor)
<b>Operating position</b>	Vertical +/- 10 degree
<b>Product certifications</b>	UL NOM 117 C-Tick CSA
<b>Marking</b>	CE
<b>Standards</b>	IEC 61800-3 category C3 IEC 61800-3 category C2 EN 61800-3 environments 1 category C3 IEC 61800-3 UL Type 1 EN 61800-3 environments 2 category C3 EN 61800-3 category C2 IEC 61800-3 environments 2 category C2 IEC 61800-3 environments 1 category C1 EN 61800-5-1 EN 61800-3 environments 2 category C1 IEC 61800-3 environments 1 category C2 EN 61800-3 category C3 EN 61800-3 environments 2 category C2 IEC 61800-3 environments 1 category C3 IEC 61800-3 environments 2 category C3 IEC 61800-5-1 EN 61800-3 EN 61800-3 environments 1 category C1 EN 61800-3 environments 1 category C2 EN 55011 class A group 1 IEC 61800-3 environments 2 category C1
<b>Assembly style</b>	With heat sink
<b>Electromagnetic compatibility</b>	Electrostatic discharge immunity test level 3 conforming to IEC 61000-4-2 Radiated radio-frequency electromagnetic field immunity test level 3 conforming to IEC 61000-4-3 Electrical fast transient/burst immunity test level 4 conforming to IEC 61000-4-4 1.2/50 µs - 8/20 µs surge immunity test level 3 conforming to IEC 61000-4-5 Conducted radio-frequency immunity test level 3 conforming to IEC 61000-4-6 Voltage dips and interruptions immunity test conforming to IEC 61000-4-11
<b>Regulation loop</b>	Adjustable PI regulator
<b>Ambient air temperature for storage</b>	-25...70 °C

## Packing Units

<b>Unit Type of Package 1</b>	PCE
<b>Number of Units in Package 1</b>	1
<b>Package 1 Height</b>	47 cm
<b>Package 1 Width</b>	50 cm
<b>Package 1 Length</b>	77 cm
<b>Package 1 Weight</b>	43.5 kg

## Offer Sustainability

<b>Sustainable offer status</b>	Green Premium product
<b>REACH Regulation</b>	<a href="#">REACH Declaration</a>
<b>EU RoHS Directive</b>	Pro-active compliance (Product out of EU RoHS legal scope) <a href="#">EU RoHS Declaration</a>
<b>Mercury free</b>	Yes

<b>China RoHS Regulation</b>	<a href="#">China RoHS declaration</a>
<b>RoHS exemption information</b>	Yes
<b>Environmental Disclosure</b>	<a href="#">Product Environmental Profile</a>
<b>Circularity Profile</b>	<a href="#">End of Life Information</a>
<b>WEEE</b>	The product must be disposed on European Union markets following specific waste collection and never end up in rubbish bins
<b>California proposition 65</b>	WARNING: This product can expose you to chemicals including: Lead and lead compounds, which is known to the State of California to cause cancer and birth defects or other reproductive harm. For more information go to <a href="http://www.P65Warnings.ca.gov">www.P65Warnings.ca.gov</a>

## Contractual warranty

<b>Warranty</b>	18 months
-----------------	-----------

**Dimensions**

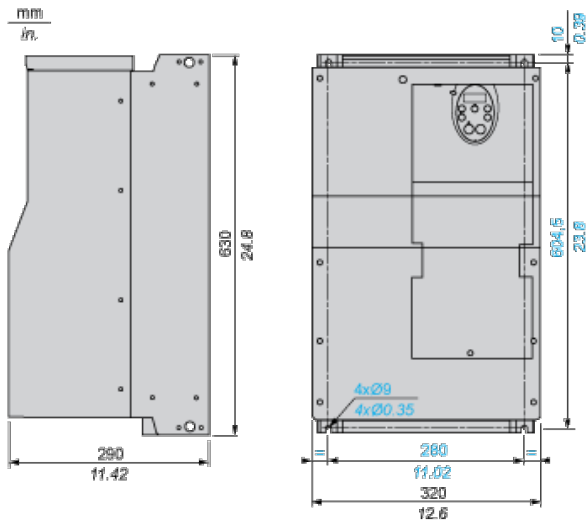

EMC mounting plate (supplied with drive)

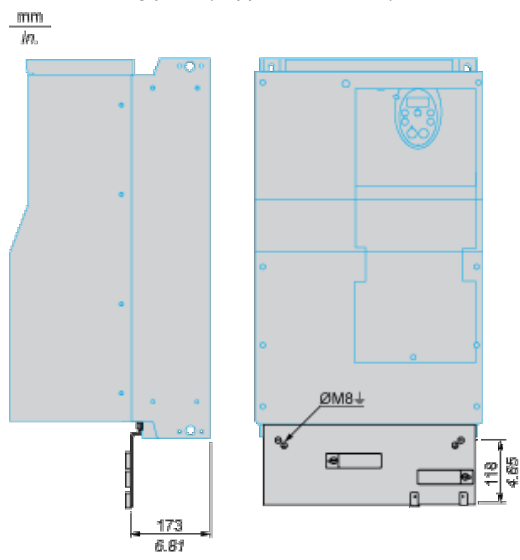

**Mounting Recommendations**

**Clearance**

Depending on the conditions in which the drive is to be used, its installation will require certain precautions and the use of appropriate accessories.

Install the unit vertically:

- Do not place it close to heating elements.
- Leave sufficient free space to ensure that the air required for cooling purposes can circulate from bottom to the top of the unit.

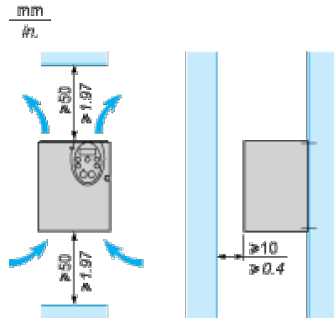

**Mounting Types**

Type A mounting

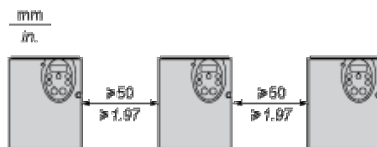

Type B mounting

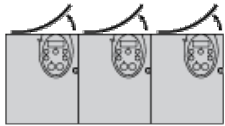

Type C mounting

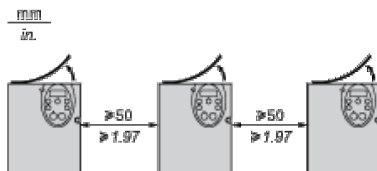

By removing the protective blanking cover from the top of the drive, the degree of protection for the drive becomes IP21. The protective blanking cover may vary according to the drive model, see opposite.

**Specific Recommendations for Mounting in an Enclosure**

---

To help ensure proper air circulation in the drive:

- Fit ventilation grilles.
- Check that there is sufficient ventilation. If there is not, install a forced ventilation unit with a filter. The openings and/or fans must provide a flow rate a
- Use special filters with UL Type 12/IP54 protection.
- Remove the blanking cover from the top of the drive.

**Sealed Metal Enclosure (IP54 Degree of Protection)**

The drive must be mounted in a dust and damp proof enclosure in certain environmental conditions, such as dust, corrosive gases, high humidity with risk of condensation and dripping water, splashing liquid, etc. This enables the drive to be used in an enclosure where the maximum internal temperature reaches 50°C.



Recommended Wiring Diagram

3-Phase Power Supply

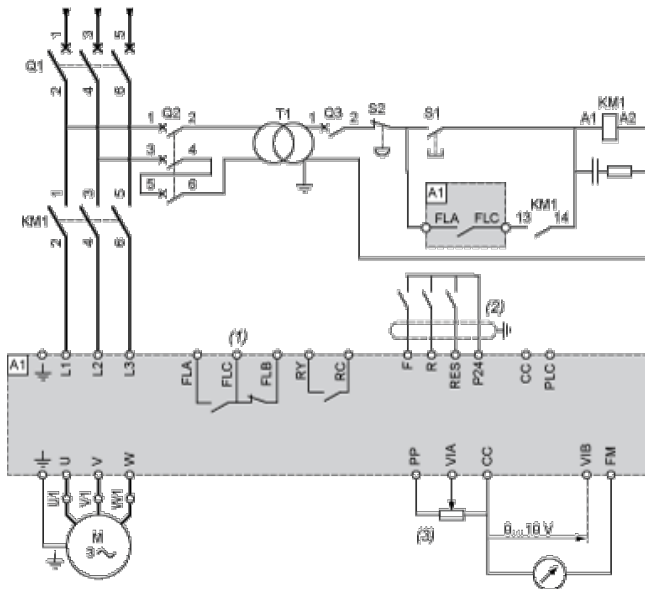

- A1: ATV 212 drive
- KM1: Contactor
- Q1: Circuit breaker
- Q2: GV2 L rated at twice the nominal primary current of T1
- Q3: GB2CB05
- S1, S2: XB4 B or XB5 A pushbuttons
- T1: 100 VA transformer 220 V secondary
- (1) Fault relay contacts for remote signalling of the drive status
- (2) Connection of the common for the logic inputs depends on the positioning of the switch (Source, PLC, Sink)
- (3) Reference potentiometer SZ1RV1202

**NOTE:** All terminals are located at the bottom of the drive. Install interference suppressors on all inductive circuits near the drive or connected on the same circuit, such as relays, contactors, solenoid valves, fluorescent lighting, etc.

Switches (Factory Settings)

Voltage/current selection for analog I/O (VIA and VIB)



Voltage/current selection for analog I/O (FM)



Selection of logic type



- (1) negative logic
- (2) positive logic

**Other Possible Wiring Diagrams**

**Logic Inputs According to the Position of the Logic Type Switch**

“Source” position

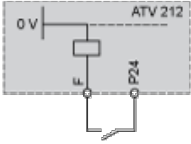

“Sink” position

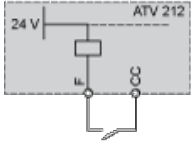

“PLC” position with PLC transistor outputs

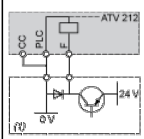

(1) PLC

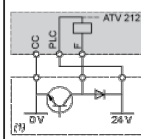

(1) PLC

2-wire control

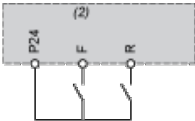

- F: Forward
- R: Preset speed
- (2) ATV 212 control terminals

3-wire control

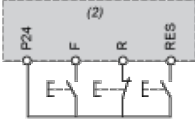

- F: Forward
- R: Stop
- RES: Reverse
- (2) ATV 212 control terminals

PTC probe

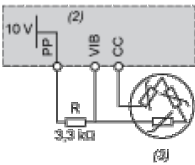

- (2) ATV 212 control terminals
- (3) Motor

**Analog Inputs**

Voltage analog inputs

External +10 V

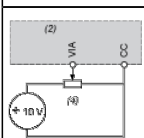

- (2) ATV 212 control terminals
- (4) Speed reference potentiometer 2.2 to 10 kΩ

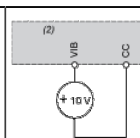

- (2) ATV 212 control terminals

Analog input configured for current: 0-20 mA, 4-20 mA, X-Y mA

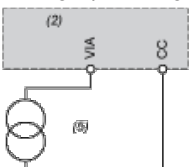

- (2) ATV 212 control terminals
- (5) Source 0-20 mA, 4-20 mA, X-Y mA

Analog input VIA configured as positive logic input ("Source" position)



(2) ATV 212 control terminals

Analog input VIA configured as negative logic input ("Sink" position)

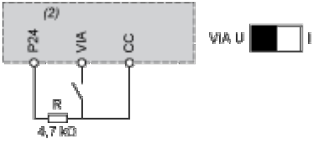

(2) ATV 212 control terminals

**Derating Curves**

The derating curves for the drive nominal current ( $I_n$ ) depend on the temperature, the switching frequency and the mounting type (A, B or C). For intermediate temperatures (45°C for example), interpolate between 2 curves.

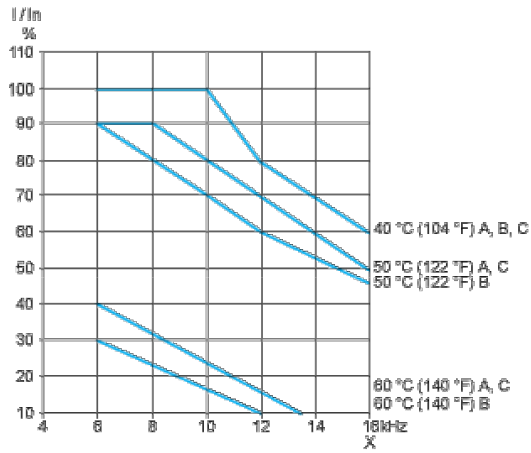

X Switching frequency

**Recommended replacement(s)**