

347874-1 ✓ ACTIVE

AMP | Econoseal

TE Internal #: 347874-1

Cable Seal, Silicone Rubber, Green, 1.1 mm [.043 in] Cavity Diameter, .062 – .094 in [1.6 – 2.4 mm] Insulation Diameter, Econoseal

[View on TE.com >](#)



Connectors > Connector Accessories > Connector Seals & Cavity Plugs



Connector Seal & Plug Type: **Cable Seal**

Primary Product Material: **Silicone Rubber**

Primary Product Color: **Green**

Cavity Diameter: **1.1 mm [.043 in]**

Compatible Insulation Diameter Range: **1.6 – 2.4 mm [.062 – .094 in]**

Features

Product Type Features

Connector Seal & Plug Type	Cable Seal
----------------------------	------------

Body Features

Primary Product Material	Silicone Rubber
Primary Product Color	Green

Dimensions

Cavity Diameter	1.1 mm[.043 in]
Compatible Insulation Diameter Range	1.6 – 2.4 mm[.062 – .094 in]

Usage Conditions

Operating Temperature (Max)	125 °C[257 °F]
Operating Temperature Range	-40 – 125 °C[-40 – 257 °F]

Packaging Features

Packaging Quantity	10000
Packaging Method	Bag

Other

Resistance to Hydrocarbons	Poor
Shore A Hardness	40
Contains Lubricant	Yes

Product Compliance

[For compliance documentation, visit the product page on TE.com>](#)

EU RoHS Directive 2011/65/EU	Compliant
EU ELV Directive 2000/53/EC	Compliant
China RoHS 2 Directive MIIT Order No 32, 2016	No Restricted Materials Above Threshold
EU REACH Regulation (EC) No. 1907/2006	Current ECHA Candidate List: JUNE 2023 (235) Candidate List Declared Against: JUNE 2022 (224) Does not contain REACH SVHC
Halogen Content	Low Halogen - Br, Cl, F, I < 900 ppm per homogenous material. Also BFR/CFR/PVC Free
Solder Process Capability	Not applicable for solder process capability

Product Compliance Disclaimer

This information is provided based on reasonable inquiry of our suppliers and represents our current actual knowledge based on the information they provided. This information is subject to change. The part numbers that TE has identified as EU RoHS compliant have a maximum concentration of 0.1% by weight in homogenous materials for lead, hexavalent chromium, mercury, PBB, PBDE, DBP, BBP, DEHP, DIBP, and 0.01% for cadmium, or qualify for an exemption to these limits as defined in the Annexes of Directive 2011/65/EU (RoHS2). Finished electrical and electronic equipment products will be CE marked as required by Directive 2011/65/EU. Components may not be CE marked. Additionally, the part numbers that TE has identified as EU ELV compliant have a maximum concentration of 0.1% by weight in homogenous materials for lead, hexavalent chromium, and mercury, and 0.01% for cadmium, or qualify for an exemption to these limits as defined in the Annexes of Directive 2000/53/EC (ELV). Regarding the REACH Regulation, the information TE provides on SVHC in articles for this part number is based on the latest European Chemicals Agency (ECHA) 'Guidance on requirements for substances in articles' posted at this URL: <https://echa.europa.eu/guidance-documents/guidance-on-reach>

Compatible Parts



Also in the Series | **Econoseal**



Automotive Connector Caps & Covers (1)

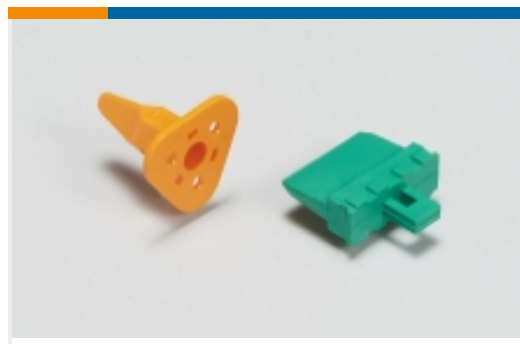

Automotive Connector Locks & Position Assurance(25)

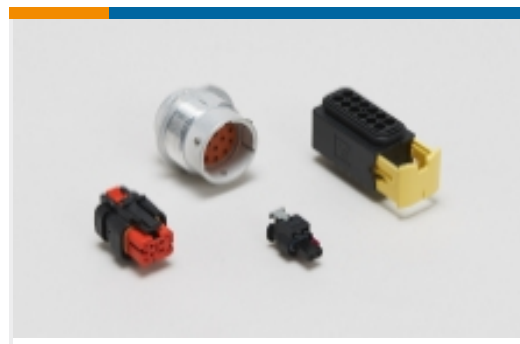

Automotive Housings(105)



Automotive Terminals(48)



Connector Seals & Cavity Plugs(19)



Insertion & Extraction Tools(7)



Other Automotive Connector Accessories(5)

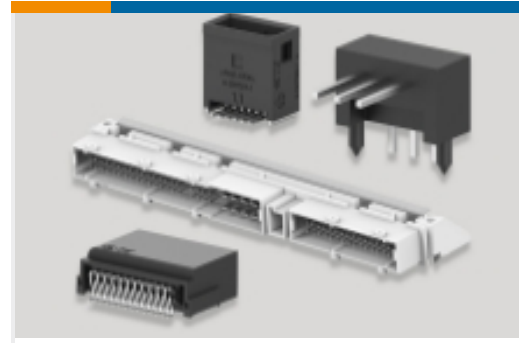

PCB Headers & Receptacles(4)



Primary Wire(1)

Customers Also Bought



TE Part #344111-1
36W EMS.REC. HSG.ASSY



TE Part #344113-1
Econoseal Receptacles and Tabs

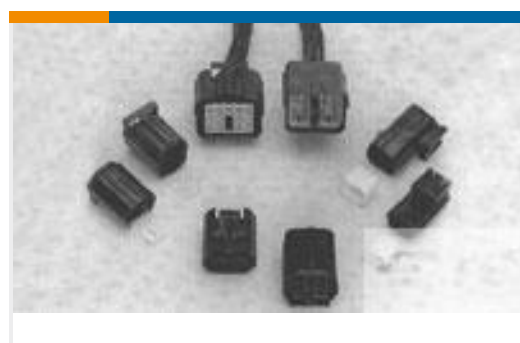

TE Part #344273-1
3 WAY REC. HSG. SIL. SEALECONO

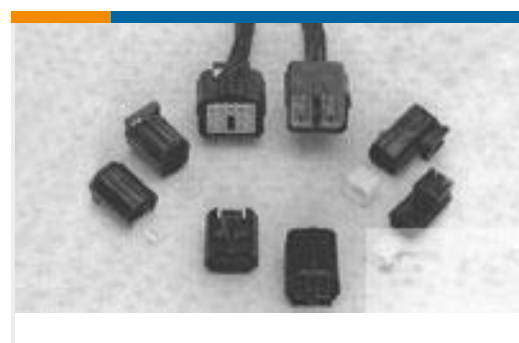

TE Part #344276-1
2 WAY REC HSG. SIL SEAL ECONO



TE Part #345254-1
ANTI-BACKOUT 2WAY REC HSGECONO

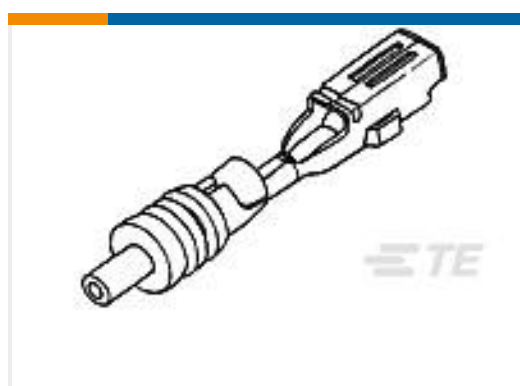

TE Part #345808-1
.070*RECEPTACLE ECON.3



TE Part #1-150504-2
BUTTON CONTACT 20-16 .0158 X .625 TPBR



TE Part #345253-1
ANTI-BACKOUT 2WAY TAB HSGECONO

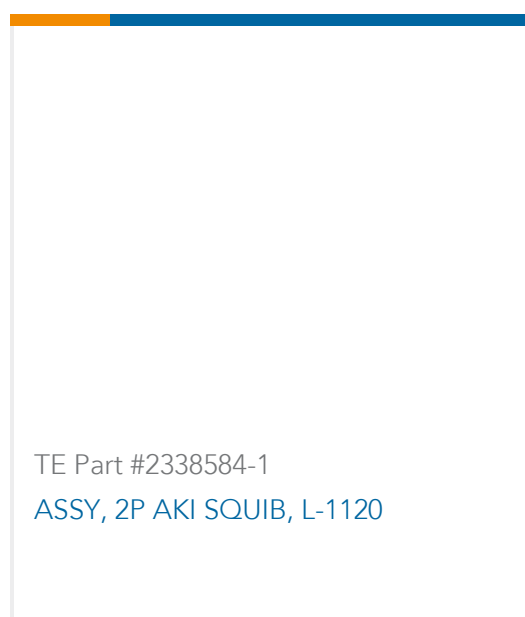

Documents

Product Drawings

[CABLE SEAL LC SILICON 0.5 T](#)

English

CAD Files

Customer View Model

[ENG_CVM_347874-1_C.3d_igs.zip](#)

English

Customer View Model

[ENG_CVM_347874-1_C.3d_stp.zip](#)

English

Customer View Model

[ENG_CVM_347874-1_C.2d_dxf.zip](#)

English

3D PDF

English

By downloading the CAD file I accept and agree to the [Terms and Conditions](#) of use.