

SUMMARY

Wires

Low voltage 8



Image is for illustrative purpose only

Series 3B
Termination type Female solder
IP rating 68 mated (mating interface)
AWG wire size 28.00 - 20.00
Cable Ø 0.00 - 0.00 mm
Status active
Matching parts [FGG.3B.308.CLAD10](#)

Download

[Request a quote](#)

[Catalog](#)

TECHNICAL DETAILS

Mechanics

Shell Style/Model HG*: Fixed receptacle, nut fixing, watertight or vacuum-tight
Keying 1 key (alpha=0, plug: male contacts, receptacle: female contacts)
Housing Material Brass (chrome plated [SAE AMS 2460]) shell and collet nut, nickel plated [SAE AMS QQ N 290] brass latch sleeve and mid pieces
Variant PV : Watertight / Vacuum-tested unmated (connector to device)
Weight 35.31 g

Performance

Configuration 3B.308 : 8 Low Voltage
Insulator L: PEEK (UL 94 / V-0/1.5)
Rated Current 13 Amps

Specifications

Contact Type: Solder
Contact Dia.: 1.3 mm (0.051in)
Bucket Dia.: 1 mm (0.039in)
Max. Solid Conductor: 0.5 mm² (AWG 20)
Max. Stranded Conductor: 0.5 mm² (AWG 20)
R (max): 3.6 mOhm

LEMO products and services are provided "as is". LEMO makes no warranties or representations with regard to LEMO product & services or use of them, express, implied or statutory, including for accuracy, completeness, or security. The user is fully responsible for his products and applications using LEMO components.

Vtest (contact-shell): 1150 V (AC), 1630 V (DC)
 Vtest (contact-contact): 1650 V (AC), 2350 V (DC)

Others

Endurance (Shell): 5000
 Temp (min / max): -20°C / +80°C
 Humidity (max): <=95% [at 60 deg C / 140 F]
 Vibration: 15 g [10 Hz - 2000 Hz]
 Shock Resistance: 100 g [6 ms]
 Climatical Category: 20/80/21
 Shielding (min): 75 dB (10 MHz)
 Shielding (min): 40 dB (1 GHz)
 R leak (He) (max): 0.0000001 mbar*l/s (if vacuum-tested)
 Salt Spray Corrosion: >1000 hr
 Pressure: 30 bars

DRAWINGS

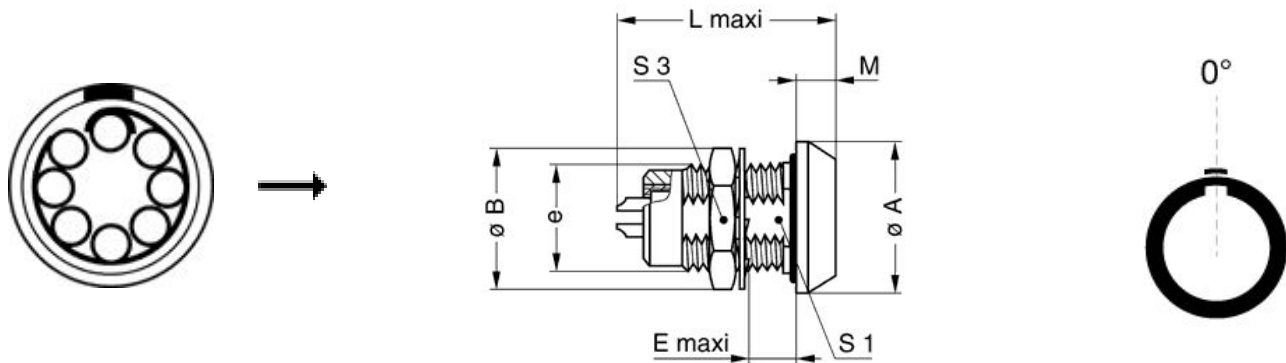

Dimensions









	A	B	E	L	M	S1	S3	e
mm.	25	25	11.5	36.1	4	16.5	22	M18x1.0
in.	0,98	0,98	0,45	1,42	0,16	0,65	0,87	

RECOMMENDED BY LEMO

LEMO products and services are provided "as is". LEMO makes no warranties or representations with regard to LEMO product & services or use of them, express, implied or statutory, including for accuracy, completeness, or security. The user is fully responsible for his products and applications using LEMO components.

Tools

Cables

CMN.08.T20.067PGCE	PVC	Grey	
CMN.08.T20.067PGZE		Grey	
CMN.08.T20.067PNZE			
CMN.08.T22.059QGC	TPR	Grey	
CMN.08.T22.059QGZE	TPR (medical)	Grey	
CMN.08.T26.042QGZE	TPR (medical)	Grey	
108220	PVC	Black	
108240	PTFE	White	
108260	PTFE	White	
16080	PVC	Grey	
180240	PVC	Black	
180260	PVC	Black	
280250	PVC	Grey	
335990	PVC	Black	
335991	PVC	Black	
380500	PVC	Grey	
380750	PVC	Grey	
42265	PVC	Yellow	
80140	PVC	Grey	
8050	PVC	Black	
8280	PVC	Black	

LEMO products and services are provided "as is". LEMO makes no warranties or representations with regard to LEMO product & services or use of them, express, implied or statutory, including for accuracy, completeness, or security. The user is fully responsible for his products and applications using LEMO components.