

DS1488 Quad Line Driver

General Description

The DS1488 is a quad line driver which converts standard TTL input logic levels through one stage of inversion to output levels which meet EIA Standard RS-232D and CCITT Recommendation V.24.

Features

- Current limited output: ± 10 mA typ
- Power-off source impedance: 300Ω min
- Simple slew rate control with external capacitor
- Flexible operating supply range
- Inputs are TTL/LS compatible

Schematic and Connection Diagrams

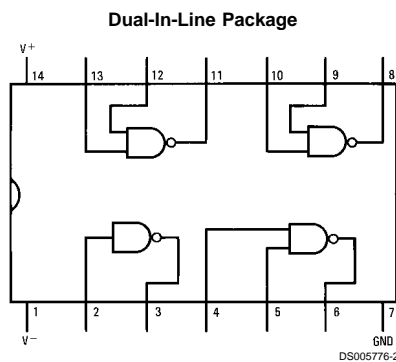
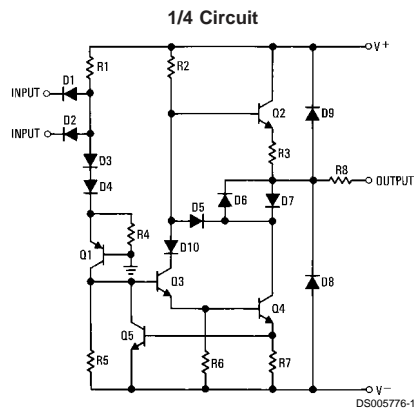

Top View
Order Number DS1488M or DS1488N
See NS Package Number M14A or N14A

Absolute Maximum Ratings (Note 2)

If Military/Aerospace specified devices are required, please contact the National Semiconductor Sales Office/Distributors for availability and specifications.

Supply Voltage

V⁺ +15V

V⁻ -15V

Input Voltage (V_{IN}) -15V ≤ V_{IN} ≤ 7.0V

Output Voltage ±15V

Operating Temperature Range 0°C to +75°C

Storage Temperature Range -65°C to +150°C

Maximum Power Dissipation (Note 1) at 25°C

Molded DIP Package 1280 mW

SO Package 974 mW

Lead Temperature (Soldering, 4 sec.) 260°C

Note 1: Derate molded DIP package 10.2 mW/°C above 25°C; derate SO package 7.8 mW/°C above 25°C.

Electrical Characteristics (Notes 3, 4)

V_{CC+} = 9V, V_{CC-} = -9V unless otherwise specified

Symbol	Parameter	Conditions	Min	Typ	Max	Units
I _{IL}	Logical "0" Input Current	V _{IN} = 0V		-0.8	-1.3	mA
I _{IH}	Logical "1" Input Current	V _{IN} = +5.0V		0.005	10.0	μA
V _{OH}	High Level Output Voltage	R _L = 3.0 kΩ, V ⁺ = 9.0V, V ⁻ = -9.0V V _{IN} = 0.8V	6.0	7.1		V
V _{OL}	Low Level Output Voltage	R _L = 3.0 kΩ, V ⁺ = 9.0V, V ⁻ = -9.0V V _{IN} = 1.9V	-6.0	7.0		V
I _{OS+}	High Level Output Short-Circuit Current	V _{OUT} = 0V, V _{IN} = 0.8V	-6.0	-10.0	-12.0	mA
I _{OS-}	Low Level Output Short-Circuit Current	V _{OUT} = 0V, V _{IN} = 1.9V	6.0	10.0	12.0	mA
R _{OUT}	Output Resistance	V ⁺ = V ⁻ = 0V, V _{OUT} = ±2V	300			Ω
I _{CC+}	Positive Supply Current (Output Open)	V _{IN} = 1.9V V ⁺ = 9.0V, V ⁻ = -9.0V V ⁺ = 12V, V ⁻ = -12V V ⁺ = 15V, V ⁻ = -15V		11.6 15.7 19.4	20.0 25.0 34.0	mA
		V _{IN} = 0.8V V ⁺ = 9.0V, V ⁻ = -9.0V V ⁺ = 12V, V ⁻ = -12V V ⁺ = 15V, V ⁻ = -15V		3.4 4.1 9.1	6.0 7.0 12.0	mA
I _{CC-}	Negative Supply Current (Output Open)	V _{IN} = 1.9V V ⁺ = 9.0V, V ⁻ = -9.0V V ⁺ = 12V, V ⁻ = -12V V ⁺ = 15V, V ⁻ = -15V		-10.8 -14.6 -18.3	-17.0 -23.0 -34.0	mA
		V _{IN} = 0.8V V ⁺ = 9.0V, V ⁻ = -9.0V V ⁺ = 12V, V ⁻ = -12V V ⁺ = 15V, V ⁻ = -15V		-0.001 -0.001 -0.01	-0.100 -0.100 -2.5	mA
P _d	Power Dissipation	V ⁺ = 9.0V, V ⁻ = -9.0V V ⁺ = 12V, V ⁻ = -12V		252 444	333 576	mW

Switching Characteristics

(V_{CC} = 9V, V_{EE} = -9V, T_A = 25°C)

Symbol	Parameter	Conditions	Min	Typ	Max	Units
t _{pd1}	Propagation Delay to a Logical "1"	R _L = 3.0 kΩ, C _L = 15 pF, T _A = 25°C		187	350	ns
t _{pd0}	Propagation Delay to a Logical "0"	R _L = 3.0 kΩ, C _L = 15 pF, T _A = 25°C		45	175	ns
t _r	Rise Time	R _L = 3.0 kΩ, C _L = 15 pF, T _A = 25°C		63	100	ns
t _f	Fall Time	R _L = 3.0 kΩ, C _L = 15 pF, T _A = 25°C		33	75	ns

Note 2: "Absolute Maximum Ratings" are those values beyond which the safety of the device cannot be guaranteed. Except for "Operating Temperature Range" they are not meant to imply that the devices should be operated at these limits. The table of "Electrical Characteristics" provides conditions for actual device operation.

Note 3: Unless otherwise specified min/max limits apply across the 0°C to +75°C temperature range for the DS1488.

Note 4: All currents into device pins shown as positive, out of device pins as negative, all voltages referenced to ground unless otherwise noted. All values shown as max or min on absolute value basis.

Applications

By connecting a capacitor to each driver output the slew rate can be controlled utilizing the output current limiting characteristics of the DS1488. For a set slew rate the appropriate capacitor value may be calculated using the following relationship

$$C = I_{SC} (\Delta T / \Delta V)$$

where C is the required capacitor, I_{SC} is the short circuit current value, and $\Delta V / \Delta T$ is the slew rate.

RS-232C specifies that the output slew rate must not exceed 30V per microsecond. Using the worst case output short circuit current of 12 mA in the above equation, calculations result in a required capacitor of 400 pF connected to each output.

See Typical Performance Characteristics.

Typical Applications

RS-232C Data Transmission

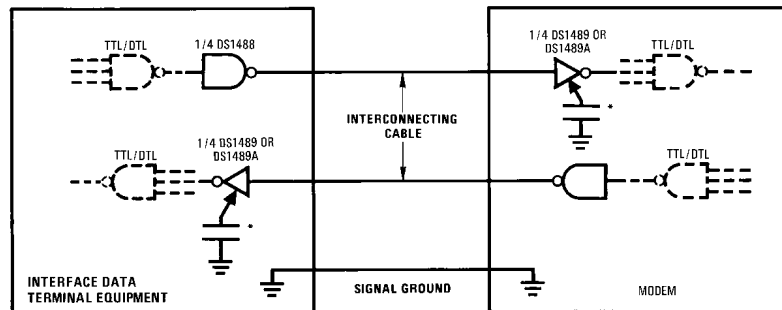

DS005776-3

Note 5: Optional for noise filtering

DTL/TTL-to-MOS Translator

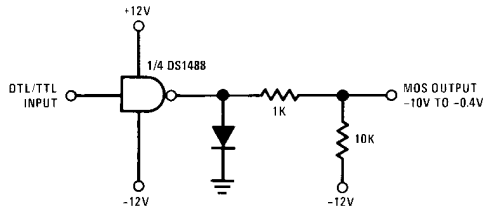

DS005776-4

DTL/TTL-to-HTL Translator

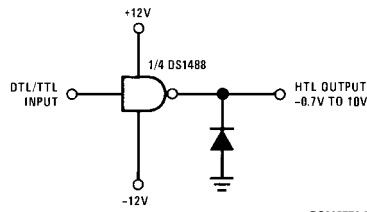

DS005776-5

DTL/TTL-to-RTL Translator

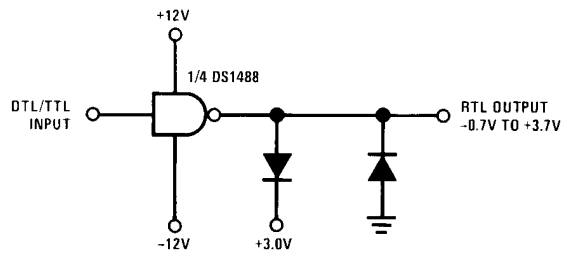

DS005776-6

AC Load Circuit and Switching Time Waveforms

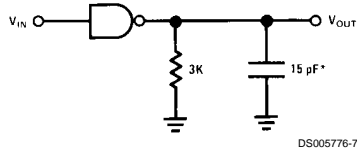

* C_L includes probe and jig capacitance.

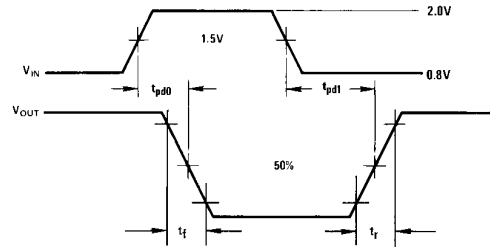

t_r and t_f are measured between 10% and 90% of the output waveform.

Typical Performance Characteristics $T_A = +25^\circ\text{C}$ unless otherwise noted

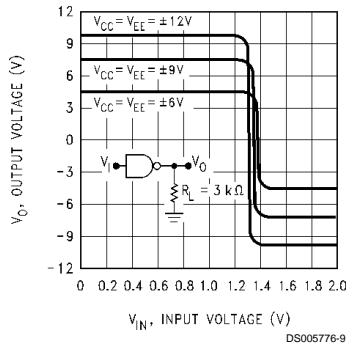

FIGURE 1. Transfer Characteristics vs Power Supply Voltage

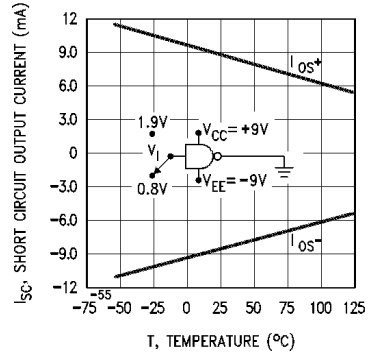

FIGURE 2. Short-Circuit Output Current vs Temperature

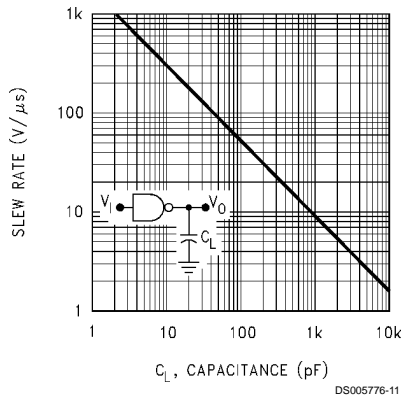

FIGURE 3. Output Slew Rate vs Load Capacitance

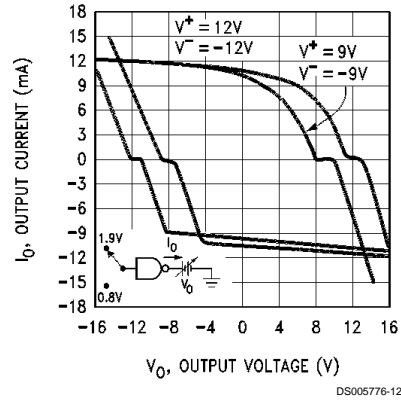
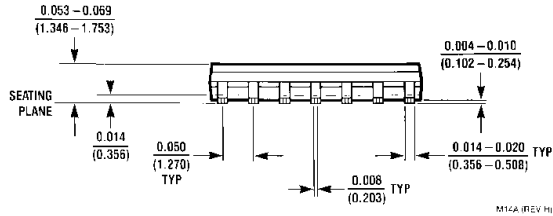
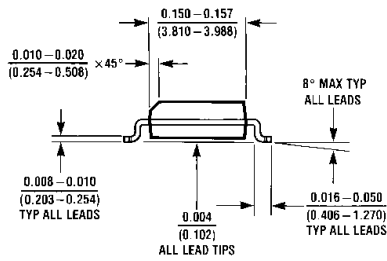
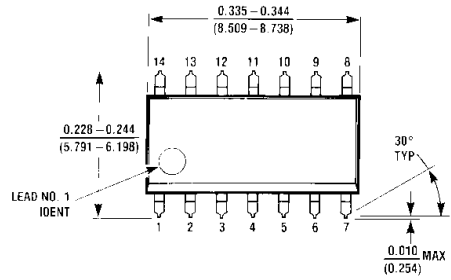

FIGURE 4. Output Voltage and Current-Limiting Characteristics

Physical Dimensions inches (millimeters) unless otherwise noted



M14A (REV H)

SO Package (M)
Order Number DS1488M
NS Package Number M14A

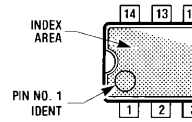
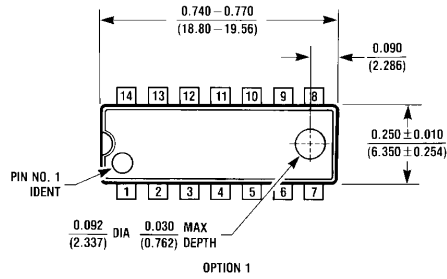

OPTION 02

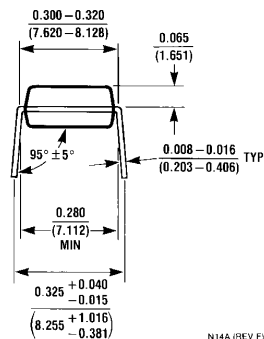
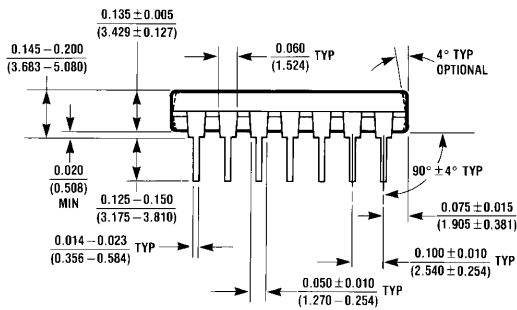

N14A (REV F)

Molded Dual-In-Line Package (N)
Order Number DS1488N
NS Package Number N14A

Notes

LIFE SUPPORT POLICY

NATIONAL'S PRODUCTS ARE NOT AUTHORIZED FOR USE AS CRITICAL COMPONENTS IN LIFE SUPPORT DEVICES OR SYSTEMS WITHOUT THE EXPRESS WRITTEN APPROVAL OF THE PRESIDENT AND GENERAL COUNSEL OF NATIONAL SEMICONDUCTOR CORPORATION. As used herein:

1. Life support devices or systems are devices or systems which, (a) are intended for surgical implant into the body, or (b) support or sustain life, and whose failure to perform when properly used in accordance with instructions for use provided in the labeling, can be reasonably expected to result in a significant injury to the user.
2. A critical component is any component of a life support device or system whose failure to perform can be reasonably expected to cause the failure of the life support device or system, or to affect its safety or effectiveness.



National Semiconductor Corporation
Americas
Tel: 1-800-272-9959
Fax: 1-800-737-7018
Email: support@nsc.com

www.national.com

National Semiconductor Europe
Fax: +49 (0) 1 80-530 85 86
Email: europe.support@nsc.com
Deutsch Tel: +49 (0) 1 80-530 85 85
English Tel: +49 (0) 1 80-532 78 32
Français Tel: +49 (0) 1 80-532 93 58
Italiano Tel: +49 (0) 1 80-534 16 80

National Semiconductor Asia Pacific Customer Response Group
Tel: 65-2544466
Fax: 65-2504466
Email: sea.support@nsc.com

National Semiconductor Japan Ltd.
Tel: 81-3-5639-7560
Fax: 81-3-5639-7507

See Power Products

Products > Analog - Interface > Data Transmission Circuits > RS-232 Serial Port Devices(Drivers or Receivers) > DS1488

DS1488 Product Folder

Quad Line Driver

See Also: [DS14C88](#) - lower power (CMOS version)

[General Description](#)

[Features](#)

[Datasheet](#)

[Package & Models](#)

[Samples & Pricing](#)

[Application Notes](#)

Parametric Table

Number of Drivers	4
Number of Receivers	0

Parametric Table

Supply Voltage	± 9 V to ± 15 V
Process	Bipolar

Datasheet

Title	Size in Kbytes	Date	View Online	Download	Receive via Email
DS1488 Quad Line Driver	161 Kbytes	13-Sep-99	View Online	Download	Receive via Email
DS1488 Quad Line Driver (JAPANESE)	239 Kbytes		View Online	Download	Receive via

If you have trouble printing or viewing PDF file(s), see [Printing Problems](#).

Package Availability, Models, Samples & Pricing

Part Number	Package			Status	Models		Samples & Electronic Orders	Budgetary Pricing		Std Pack Size	Package Marking
	Type	Pins	MSL		SPICE	IBIS		Qty	\$US each		
DS1488M	SOIC NARROW	14	MSL	Full production	N/A	N/A	24 Hour Buy Now	1K+	\$0.1400	rail of 55	[logo]UçZç2çT DS1488M
DS1488MX	SOIC NARROW	14	MSL	Full production	N/A	N/A	Buy Now	1K+	\$0.1400	reel of 2500	[logo]UçZç2çT DS1488M
DS1488N	MDIP	14	MSL	Full production	N/A	N/A	Buy Now	1K+	\$0.1500	rail of 25	[logo]UçZç3çT DS1488N MC1488P

DS1488 MDC	Die	Full production	N/A	N/A	Samples			tray of N/A	-
DS1488 MWC	Wafer	Full production	N/A	N/A				wafer jar of N/A	-

General Description

The DS1488 is a quad line driver which converts standard TTL input logic levels through one stage of inversion to output levels which meet EIA Standard RS-232D and CCITT Recommendation V.24.

Features

- Current limited output: ± 10 mA typ
- Power-off source impedance: 300 Ohm min
- Simple slew rate control with external capacitor
- Flexible operating supply range
- Inputs are TTL/LS compatible

Application Notes

Title	Size in Kbytes	Date	<input type="checkbox"/> View Online	<input type="checkbox"/> Download	<input type="checkbox"/> Receive via Email
AN-438: Application Note 438 Low Power RS-232C Driver and Receiver in CMOS	205 Kbytes	5-Oct-98	View Online	Download	Receive via Email
SB-117: PC87310 Super I/O	68 Kbytes	28-Jun-96	View Online	Download	Receive via Email
AN-1034: An Optimized DCE Interface for V.34 Modems Using the DS8933 and DS8934 Line Drivers and Receivers	113 Kbytes	2-Apr-96	View Online	Download	Receive via Email
AN-199: A Low Component Count Video Data Terminal Using the DP8350 CRT Controller and the INS8080 CPU	509 Kbytes	4-Nov-95	View Online	Download	Receive via Email
AN-270: Software Design for a 38.4 kbaud Data Terminal	882 Kbytes	4-Nov-95	View Online	Download	Receive via Email
AN-280: A/D Converters Easily Interface with 70 Series Microprocessors	134 Kbytes	9-Apr-96	View Online	Download	Receive via Email
AN-496: The BIPLAN DP8342/DP8343 Bi-Phase Local Area Network	488 Kbytes	4-Nov-95	View Online	Download	Receive via Email

If you have trouble printing or viewing PDF file(s), see [Printing Problems](#).

[Information as of 5-Aug-2002]

Search

[Design](#)

[Purchasing](#)

[Quality](#)

[Company](#)

[Home](#)

