

SFH 4735

OSLON® Black Flat

OSLON Black Flat (IR broad band emitter) - 120°

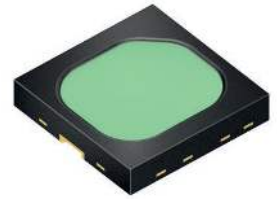

Applications

- Infrared Spectroscopy

Features:

- Package: diffuse silicone
- ESD: 2 kV acc. to ANSI/ESDA/JEDEC JS-001 (HBM, Class 2)
- Spectral range of emission: (typ) 650 ... 1050 nm
- Wide viewing angle of 120°
- Low thermal resistance (Max. 9 K/W)

Ordering Information

Type	Total radiant flux ¹⁾ typ. $I_F = 350 \text{ mA}; \lambda = 600\text{nm} - 1050\text{nm}; t_p = 20\text{ms}$ Φ_e	Ordering Code
SFH 4735	16 mW	Q65111A9885

Discontinued

Maximum Ratings

$T_A = 25\text{ °C}$

Parameter	Symbol		Values
Operating temperature	T_{op}	min. max.	-40 °C 85 °C
Storage temperature	T_{stg}	min. max.	-40 °C 85 °C
Junction temperature	T_j	max.	125 °C
Forward current	I_F	max.	500 mA
Surge current $t_p \leq 1\text{ ms}; D = 0$	I_{FSM}	max.	1 A
Reverse current ²⁾	I_R	max.	200 mA
Power consumption	P_{tot}	max.	1900 W
ESD withstand voltage acc. to ANSI/ESDA/JEDEC JS-001 (HBM, Class 2)	V_{ESD}	max.	2 kV

For the forward current and power consumption please see “maximum permissible forward current” diagram

Characteristics

$I_F = 350 \text{ mA}$; $t_p = 20 \text{ ms}$; $T_A = 25 \text{ °C}$

Parameter	Symbol		Values
Half angle	φ	typ.	60 °
Forward voltage	V_F	typ. max.	2.95 V 3.5 V
Forward voltage $I_F = 500 \text{ mA}$; $t_p = 100 \mu\text{s}$	V_F	typ. max.	3 V 3.8 V
Reverse voltage ²⁾ $I_R = 20 \text{ mA}$	V_R	max.	1.2 V
Reverse voltage (ESD device) ²⁾	$V_{R\text{ESD}}$	min.	45 V
Radiant intensity ³⁾ $\lambda = 350 - 600 \text{ nm}$	I_e	typ.	59 mW/sr
Radiant intensity ³⁾ $\lambda = 600 - 1050 \text{ nm}$	I_e	typ.	5 mW/sr
Total radiant flux ¹⁾ $\lambda = 350 - 600 \text{ nm}$	Φ_e	typ.	184 mW
Total radiant flux ¹⁾ $\lambda = 600 - 1050 \text{ nm}$	Φ_e	typ.	16 mW
Spectral flux $\lambda = 750 \text{ nm}$	$\Phi_{e,\lambda}$	typ.	60 $\mu\text{W/nm}$
Spectral flux $\lambda = 850 \text{ nm}$	$\Phi_{e,\lambda}$	typ.	45 $\mu\text{W/nm}$
Spectral flux $\lambda = 950 \text{ nm}$	$\Phi_{e,\lambda}$	typ.	45 $\mu\text{W/nm}$
Thermal resistance junction solder point real ⁴⁾	R_{thJS}	max.	9.0 K / W

Relative Spectral Emission 5), 6)

$$I_{e,rel} = f(\lambda); I_F = 350 \text{ mA}; t_p = 10 \text{ ms}$$

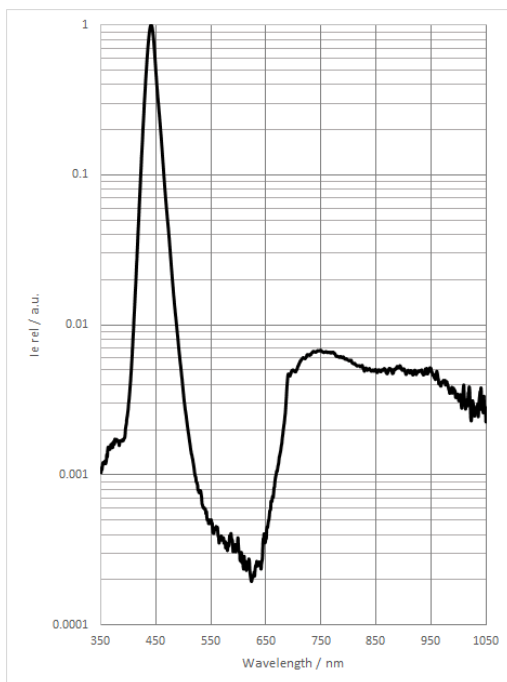

Radiation Characteristics 5), 6)

$$I_{e,rel} = f(\varphi)$$

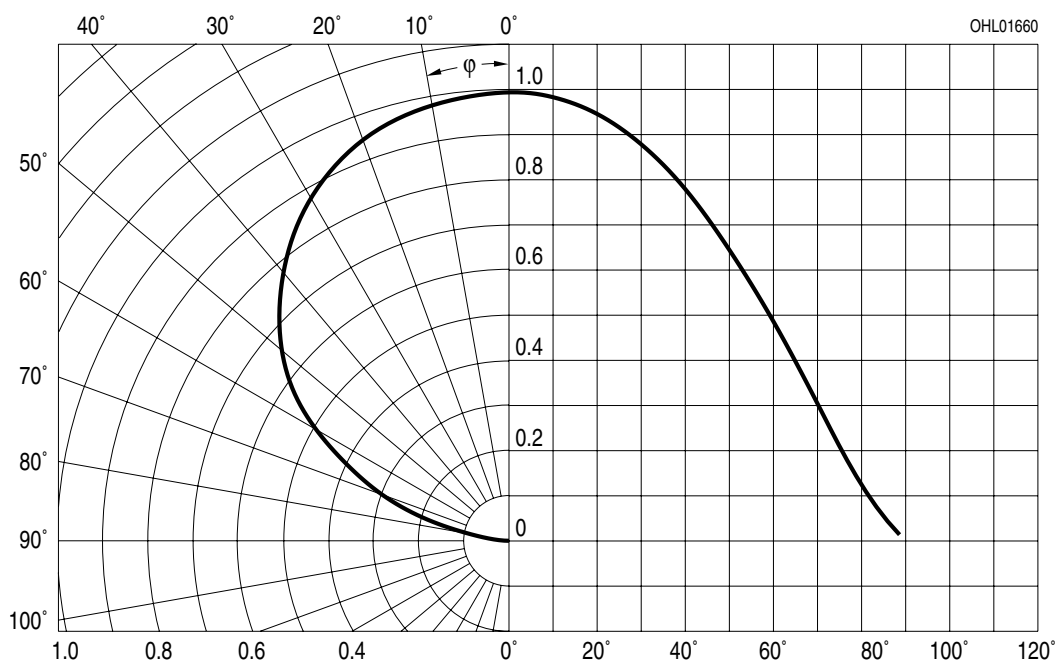

Discontinued

Forward current ^{5), 6)}

$I_F = f(V_F)$; single pulse; $t_p = 100 \mu s$

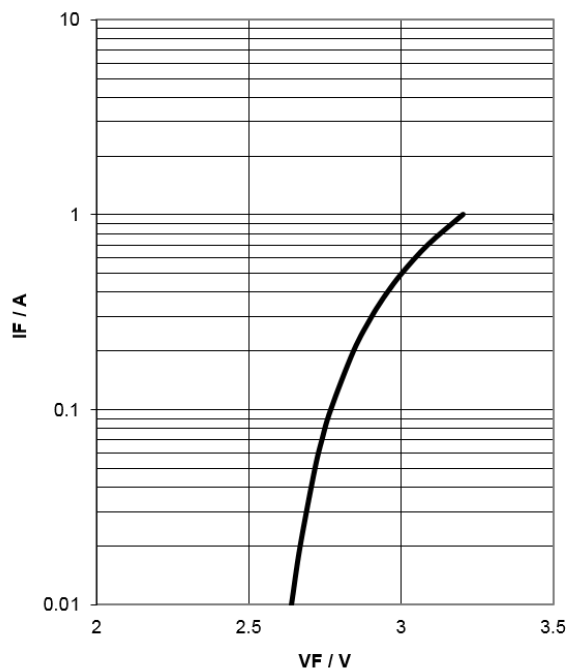

Relative Total Radiant Flux ^{5), 6)}

$\Phi_e / \Phi_e(350mA) = f(I_F)$; $\lambda = 600 \text{ nm} - 1050 \text{ nm}$; single pulse; $t_p = 20 \text{ ms}$

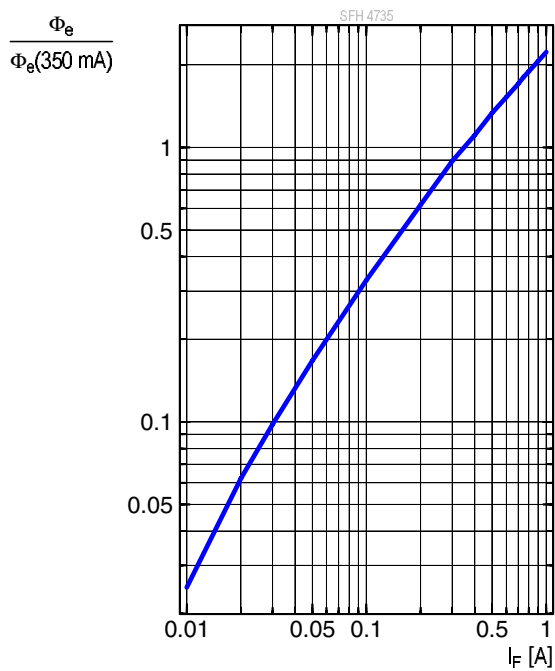

Discontinued

Max. Permissible Forward Current

$I_{F,max} = f(T_S); R_{th_{js}} = 9K / W_{single\ pulse}$

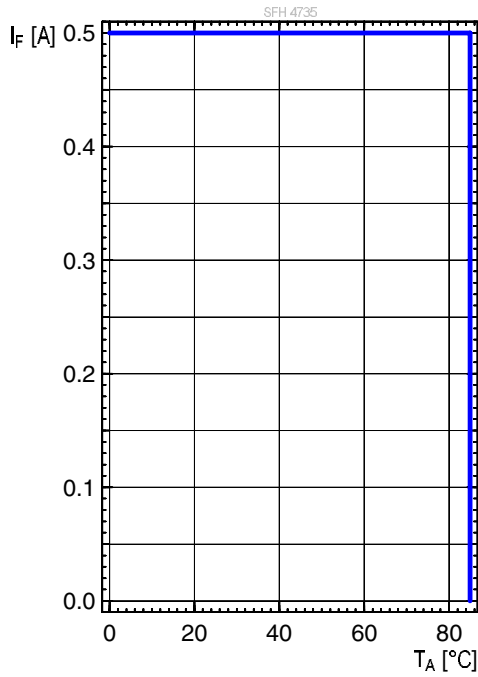

Permissible Pulse Handling Capability

$I_F = f(t_p); \text{duty cycle } D = \text{parameter}; T_S = 85^\circ C$

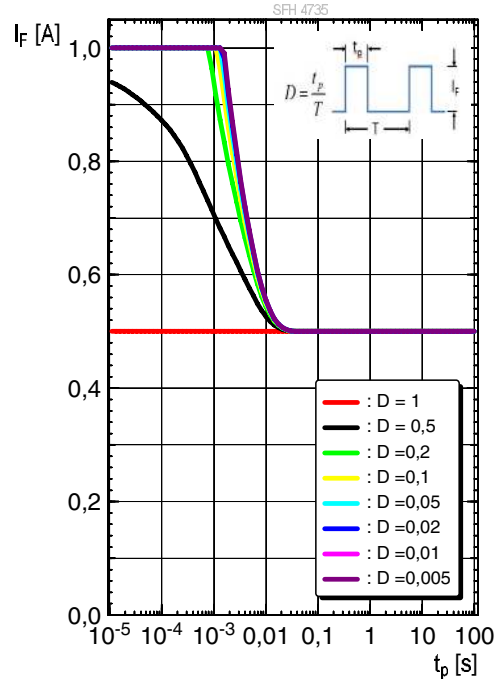

Discontinued

Dimensional Drawing ⁷⁾

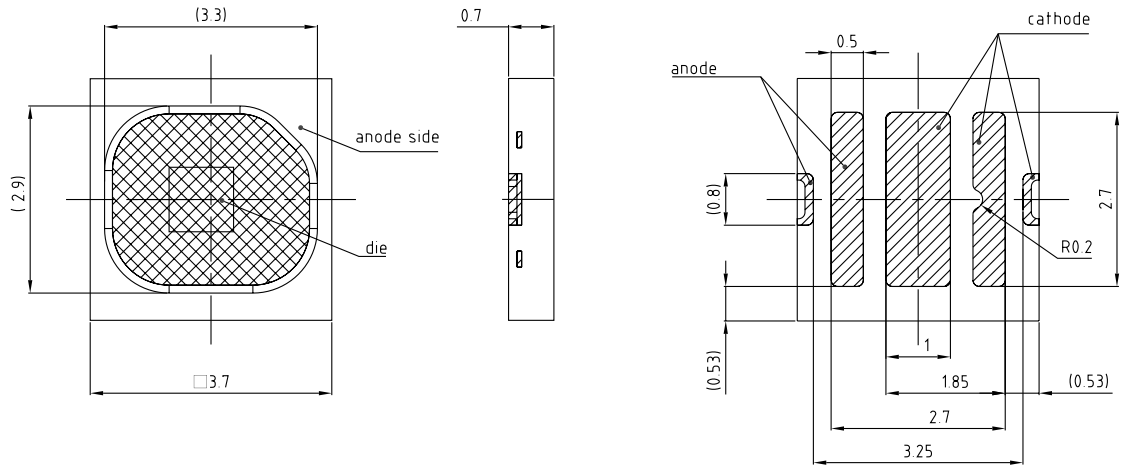

general tolerance ± 0.1
 lead finish Au 

C67062-A0189-A103

Further Information

Approximate Weight: 23.0 mg

Package marking: Anode

ESD advice: The device is protected by ESD device which is connected in parallel to the Chip.

Discontinued

Recommended Solder Pad ⁷⁾

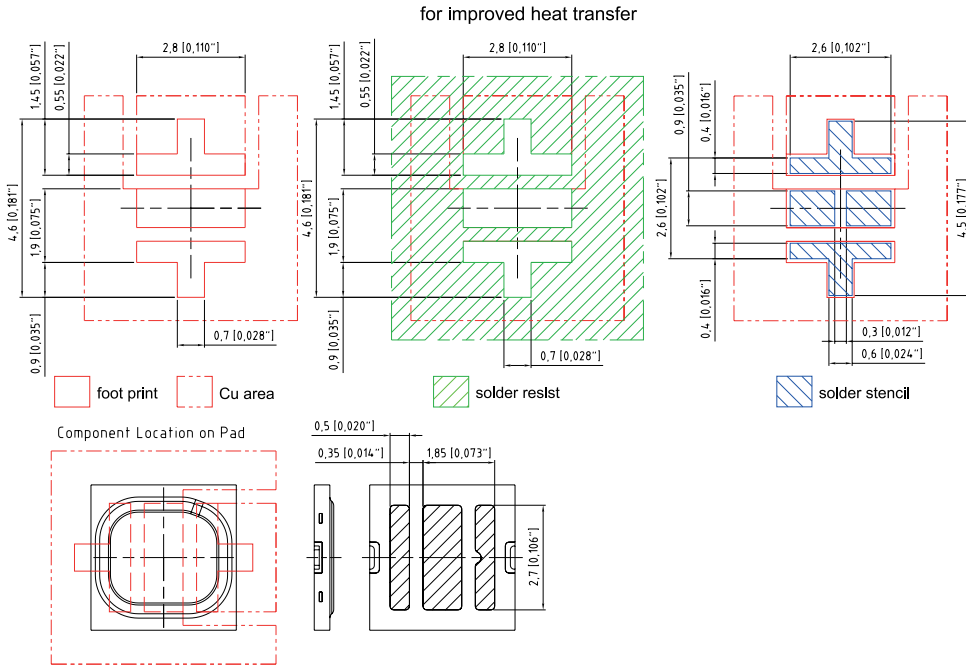

E062.3010.107 -02

Recommended Solder Pad ⁷⁾

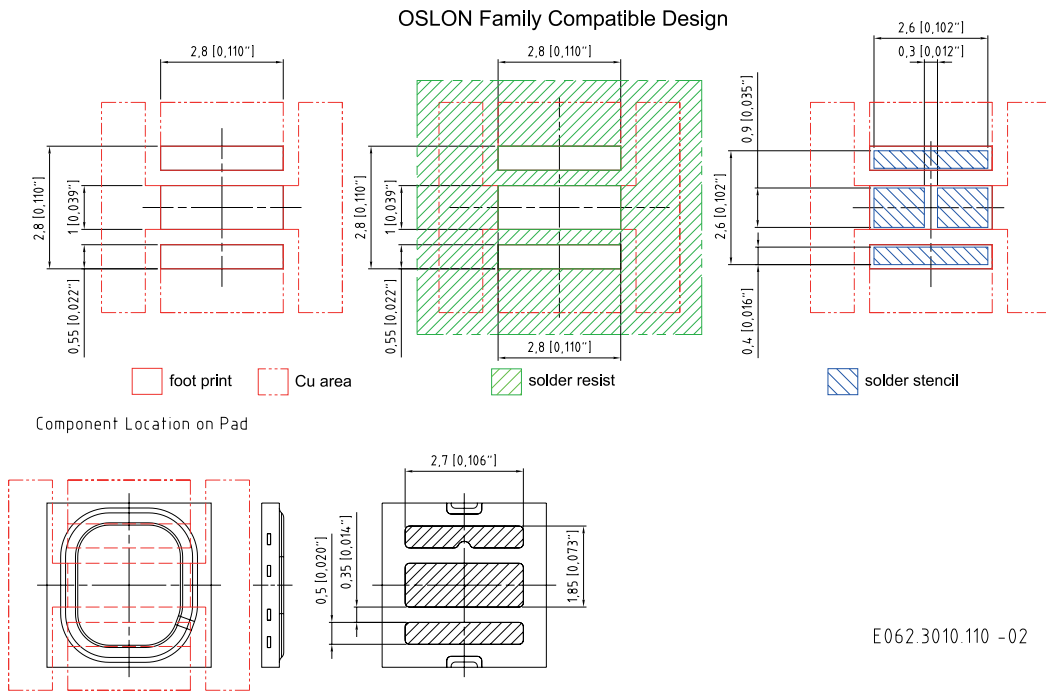

E062.3010.110 -02

For superior solder joint connectivity results we recommend soldering under standard nitrogen atmosphere.

Discontinued

Reflow Soldering Profile

Product complies to MSL Level 2 acc. to JEDEC J-STD-020E

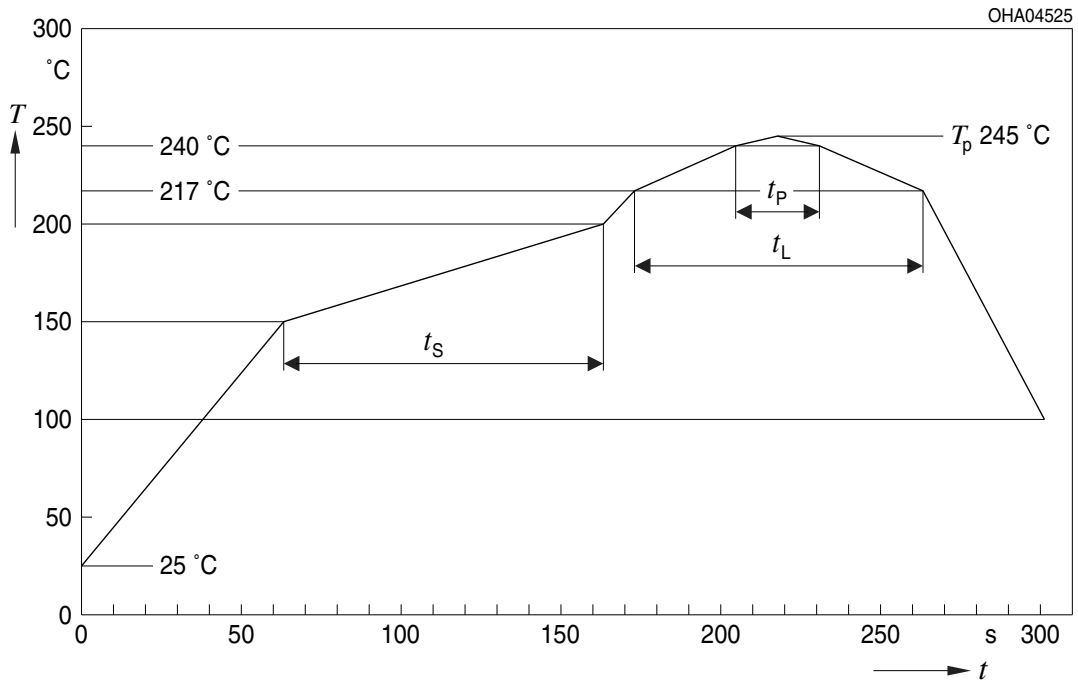

Profile Feature	Symbol	Pb-Free (SnAgCu) Assembly			Unit
		Minimum	Recommendation	Maximum	
Ramp-up rate to preheat ^{*)} 25 °C to 150 °C			2	3	K/s
Time t_s T_{Smin} to T_{Smax}	t_s	60	100	120	s
Ramp-up rate to peak ^{*)} T_{Smax} to T_p			2	3	K/s
Liquidus temperature	T_L		217		°C
Time above liquidus temperature	t_L		80	100	s
Peak temperature	T_p		245	260	°C
Time within 5 °C of the specified peak temperature $T_p - 5$ K	t_p	10	20	30	s
Ramp-down rate* T_p to 100 °C			3	6	K/s
Time 25 °C to T_p				480	s

All temperatures refer to the center of the package, measured on the top of the component
 *) slope calculation DT/Dt : Dt max. 5 s; fulfillment for the whole T-range

Discontinued

Taping ⁷⁾

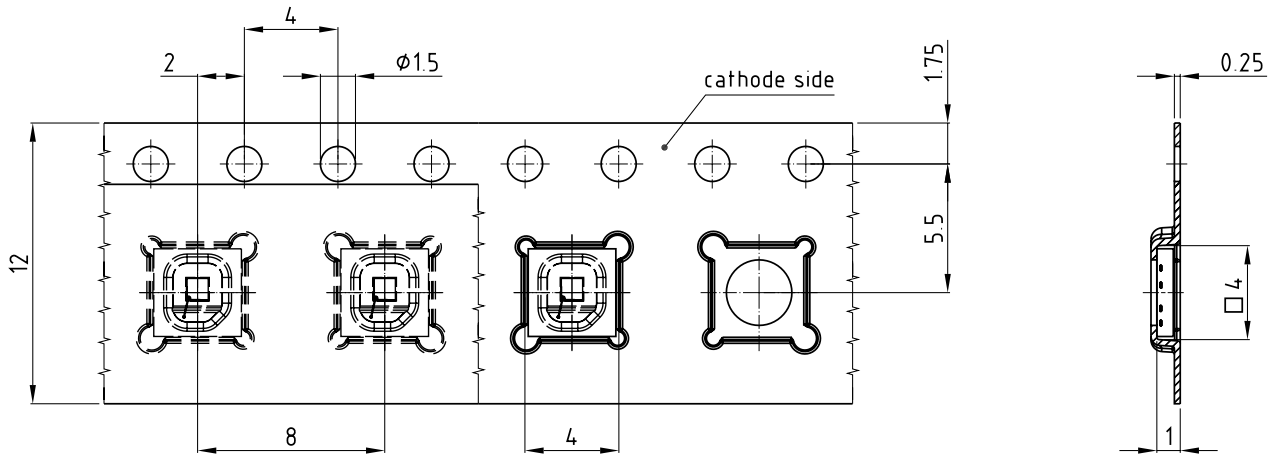

C67062-A0030-B11-06

Tape and Reel ⁸⁾

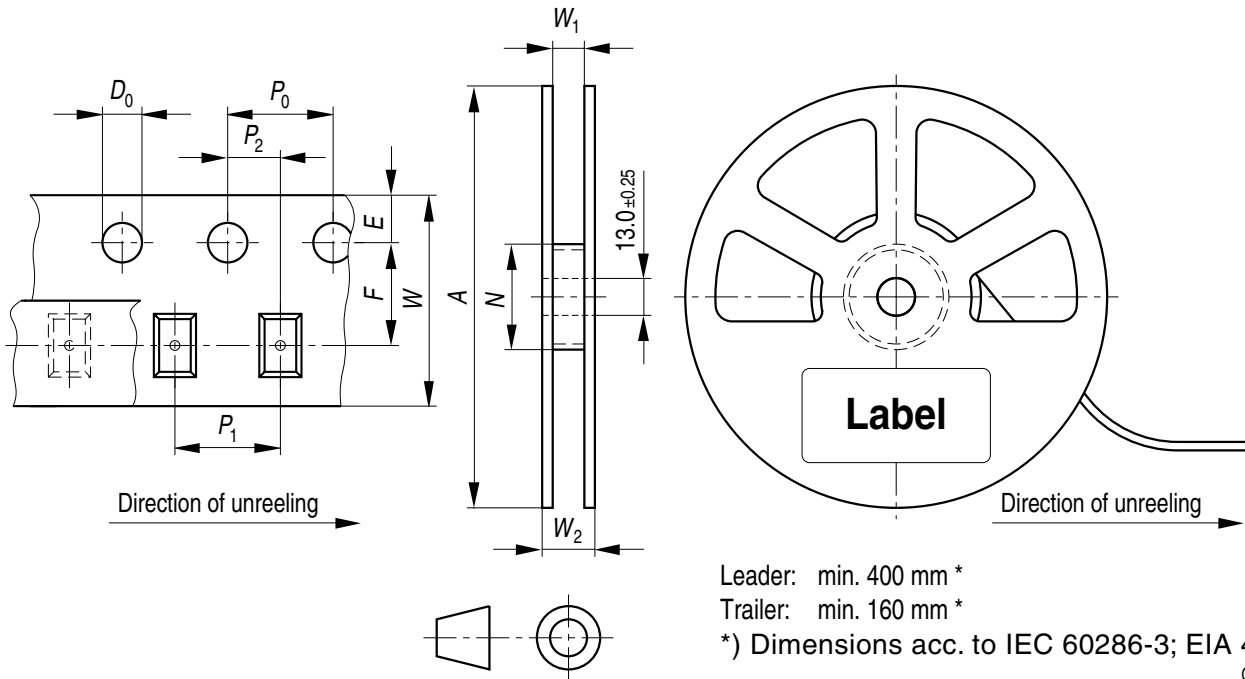

Reel Dimensions

A	W	N_{min}	W_1	W_{2max}	Pieces per PU
180 mm	12 + 0.3 / - 0.1 mm	60 mm	12.4 + 2 mm	18.4 mm	2000



Discontinued

Barcode-Product-Label (BPL)

OSRAM Opto Semiconductors LX XXXX BIN1: XX-XX-X-XXX-X

RoHS Compliant

(6P) BATCH NO: 1234567890 ML Temp ST
X XXX °C X





(1T) LOT NO: 1234567890 (9D) D/C: 1234



Pack: RXX
DEMY XXX
X_X123_1234.1234 X

(X) PROD NO: 123456789(Q)QTY: 9999 (G) GROUP: XX-XX-X-X



OHA04563

Dry Packing Process and Materials ⁷⁾

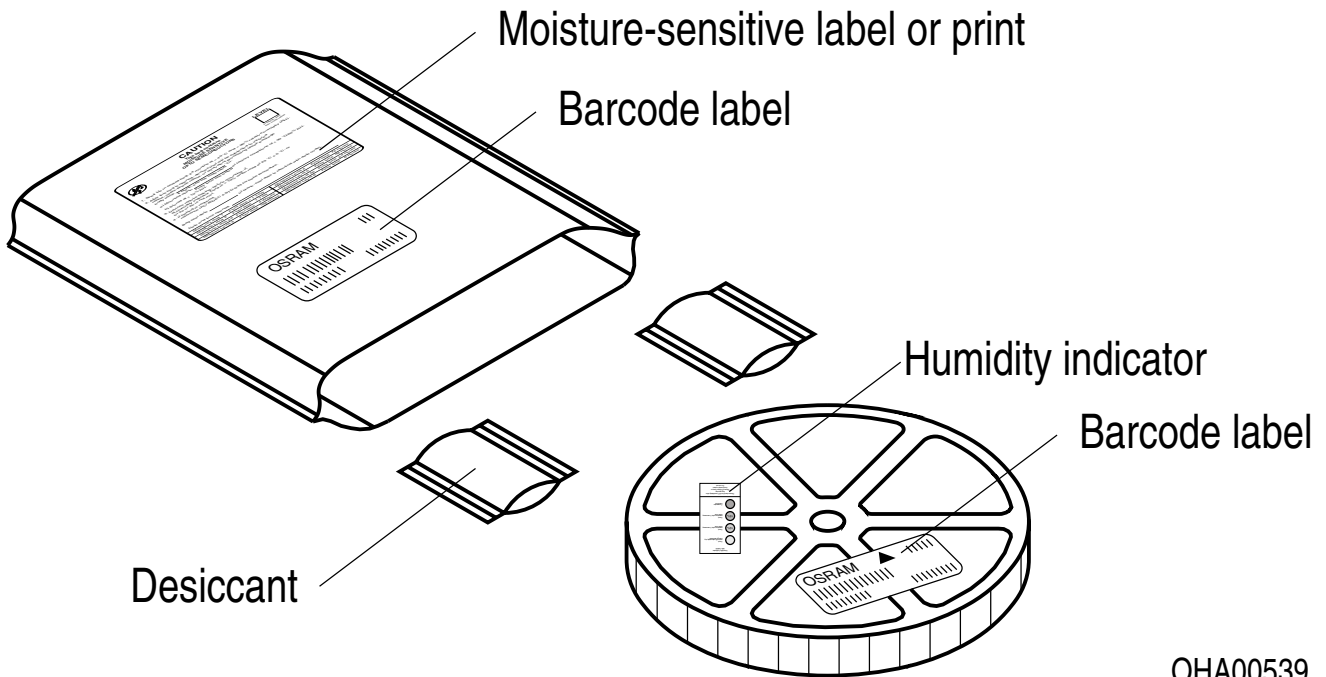

OHA00539

Moisture-sensitive product is packed in a dry bag containing desiccant and a humidity card according JEDEC-STD-033.

Discontinued

Schematic Transportation Box ⁷⁾

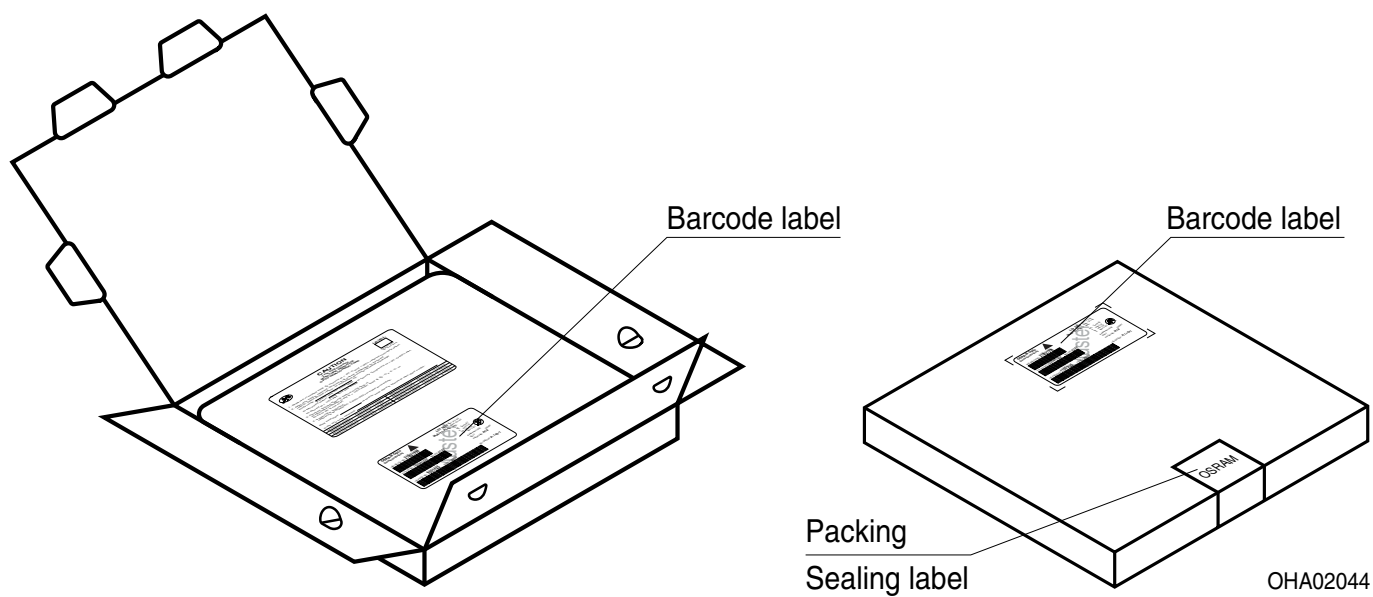

Dimensions of Transportation Box

Width	Length	Height
195 ± 5 mm	195 ± 5 mm	30 ± 5 mm

Notes

The evaluation of eye safety occurs according to the standard IEC 62471:2006 (photo biological safety of lamps and lamp systems). Within the risk grouping system of this IEC standard, the device specified in this data sheet falls into the class **moderate risk (exposure time 0.25 s)**. Under real circumstances (for exposure time, conditions of the eye pupils, observation distance), it is assumed that no endangerment to the eye exists from these devices. As a matter of principle, however, it should be mentioned that intense light sources have a high secondary exposure potential due to their blinding effect. When looking at bright light sources (e.g. headlights), temporary reduction in visual acuity and afterimages can occur, leading to irritation, annoyance, visual impairment, and even accidents, depending on the situation.

Subcomponents of this device contain, in addition to other substances, metal filled materials including silver. Metal filled materials can be affected by environments that contain traces of aggressive substances. Therefore, we recommend that customers minimize device exposure to aggressive substances during storage, production, and use. Devices that showed visible discoloration when tested using the described tests above did show no performance deviations within failure limits during the stated test duration. Respective failure limits are described in the IEC60810.

For further application related information please visit www.osram-os.com/appnotes

Disclaimer

Attention please!

The information describes the type of component and shall not be considered as assured characteristics. Terms of delivery and rights to change design reserved. Due to technical requirements components may contain dangerous substances.

For information on the types in question please contact our Sales Organization.

If printed or downloaded, please find the latest version on the OSRAM OS website.

Packing

Please use the recycling operators known to you. We can also help you – get in touch with your nearest sales office. By agreement we will take packing material back, if it is sorted. You must bear the costs of transport. For packing material that is returned to us unsorted or which we are not obliged to accept, we shall have to invoice you for any costs incurred.

Product and functional safety devices/applications or medical devices/applications

OSRAM OS components are not developed, constructed or tested for the application as safety relevant component or for the application in medical devices.

OSRAM OS products are not qualified at module and system level for such application.

In case buyer – or customer supplied by buyer – considers using OSRAM OS components in product safety devices/applications or medical devices/applications, buyer and/or customer has to inform the local sales partner of OSRAM OS immediately and OSRAM OS and buyer and /or customer will analyze and coordinate the customer-specific request between OSRAM OS and buyer and/or customer.

Glossary

- 1) **Total radiant flux:** Measured with integrating sphere.
- 2) **Reverse Operation:** Reverse Operation of 10 hours is permissible in total. Continuous reverse operation is not allowed.
- 3) **Radiant intensity:** Measured at a solid angle of $\Omega = 0.01$ sr
- 4) **Thermal resistance:** junction - soldering point, of the device only, mounted on an ideal heatsink (e.g. metal block)
- 5) **Typical Values:** Due to the special conditions of the manufacturing processes of semiconductor devices, the typical data or calculated correlations of technical parameters can only reflect statistical figures. These do not necessarily correspond to the actual parameters of each single product, which could differ from the typical data and calculated correlations or the typical characteristic line. If requested, e.g. because of technical improvements, these typ. data will be changed without any further notice.
- 6) **Testing temperature:** TA = 25°C (unless otherwise specified)
- 7) **Tolerance of Measure:** Unless otherwise noted in drawing, tolerances are specified with ± 0.1 and dimensions are specified in mm.
- 8) **Tape and Reel:** All dimensions and tolerances are specified acc. IEC 60286-3 and specified in mm.

Published by OSRAM Opto Semiconductors GmbH EU RoHS and China RoHS compliant product
Leibnizstraße 4, D-93055 Regensburg
www.osram-os.com © All Rights Reserved.



此产品符合欧盟 RoHS 指令的要求；
按照中国的相关法规和标准，不含有毒有害物质或元素。