

HCD25B15I0127-0-C

Fujitsu® HCD25B15I0127-0 Compatible TAA Compliant 25GBase-BX SFP28 Transceiver (SMF, 1270nmTx/1330nmRx, 10km, LC, -40 to 85C)

Features:

- SFF-8402 and SFF-8472 Compliance
- Simplex LC Connector
- Single-mode Fiber
- Industrial Temperature -40 to 85 Celsius
- Hot Pluggable
- Metal with Lower EMI
- Excellent ESD Protection
- RoHS Compliant and Lead Free



Applications:

- 25GBase Ethernet
- Access and Enterprise

Product Description

This Fujitsu® HCD25B15I0127-0 compatible SFP28 transceiver provides 25GBase-BX throughput up to 20km over single-mode fiber (SMF) using a wavelength of 1270nmTx/1330nmRx via an LC connector. It is guaranteed to be 100% compatible with the equivalent Fujitsu® transceiver. This easy to install, hot swappable transceiver has been programmed, uniquely serialized and data-traffic and application tested to ensure that it will initialize and perform identically. Digital optical monitoring (DOM) support is also present to allow access to real-time operating parameters. This transceiver is Trade Agreements Act (TAA) compliant. We stand behind the quality of our products and proudly offer a limited lifetime warranty.

ProLabs's transceivers are RoHS compliant and lead-free.

TAA refers to the Trade Agreements Act (19 U.S.C. & 2501-2581), which is intended to foster fair and open international trade. TAA requires that the U.S. Government may acquire only "U.S. – made or designated country end products."



Regulatory Compliance

- ESD to the Electrical PINs: compatible with MIL-STD-883E Method 3015.4
- ESD to the LC Receptacle: compatible with IEC 61000-4-3
- EMI/EMC compatible with FCC Part 15 Subpart B Rules, EN55022:2010
- Laser Eye Safety compatible with FDA 21CFR, EN60950-1& EN (IEC) 60825-1,2
- RoHS compliant with EU RoHS 2.0 directive 2015/863/EU

Absolute Maximum Ratings

Parameter	Symbol	Min.	Typ.	Max.	Unit	Notes
Maximum Supply Voltage	Vcc	0		3.6	V	+3.3V
Storage Temperature	TS	-40		85	°C	
Operating Case Temperature	Tc	-40	25	85	°C	
Optical Receiver Input	Pmax			+5.5	dBm	Average

Electrical Characteristics

Parameter	Symbol	Min.	Typ.	Max.	Unit	Notes
Power Supply Voltage	Vcc	3.135	3.30	3.465	V	
Power Supply Noise	Vrip			2 3	% %	DC – 1MHz 1 – 10MHz
Power Consumption	Pw			1.5	W	

High Speed Electrical Characteristics

Parameter	Test Point	Min.	Typ.	Max.	Unit	Notes/ Conditions
High Speed Electrical Input Characteristics						
Overload differential voltage (peak-to-peak)	TP1a	900			mV	Calibrated at TP1a Note 3: Section 13.3.12
Differential termination mismatch	TP1			10	%	At 1 MHz, Note 3: Section 13.3.6
Differential return loss (SDD11)	TP1			Note 1	dB	
Common mode to differential conversion and differential to common mode conversion (SDC11, SCD11)	TP1			Note 2	dB	
High Speed Electrical Output Characteristics						
Differential voltage, pk-pk	TP4			900	mV	
Common mode noise, RMS	TP4			17.5	mV	Note 6: Section 13.3.5
Differential termination mismatch	TP4			10	%	At 1 MHz
Differential return loss (SDD22)	TP4			Note 4	dB	
Common mode to differential conversion and differential to common mode conversion (SDC22, SCD22)	TP4			Note 5		
Transition Time, 20 to 80%	TP4	9.5			ps	Note 6: Section 13.3.10
Vertical Eye Closure (VEC)				5.5	dB	Note 6: Section 13.3.11
Eye width at 10-15 probability (EW15)	TP4	0.57			UI	Note 6: Section 13.3.11
Eye height at 10-15 probability (EH15)	TP4	228			mV	Note 6: Section 13.3.11

Notes:

- SDD11, SDD22 < -11dB for $0.05 < f < f_b/7$ ($f_b=28\text{GHz}$)
SDD11, SDD22 < $-6.0+9.2*\log_{10}(2f/f_b)$ dB for $f_b/7 < f < f_b$ ($f_b=28\text{GHz}$)
- SDC11, SCD11 < $-22+14*(f/f_b)$ dB for $0.05 < f < f_b/2$ ($f_b=28\text{GHz}$)
SDC11, SCD11 < $-18+6*f/f_b$ dB for $f_b/2 < f < f_b$ ($f_b=28\text{GHz}$)
- Ref OIF-CEI-28G-VSR as described in Implementation Agreement OIF-CEI-03.1
- SDD11, SDD22 < -11dB for $0.05 < f < f_b/7$ ($f_b=28\text{GHz}$)
SDD11, SDD22 < $-6.0+9.2*\log_{10}(2f/f_b)$ dB for $f_b/7 < f < f_b$ ($f_b=28\text{GHz}$)
- SDC22, SCD22 < $-25+20*(f/f_b)$ dB for $0.05 < f < f_b/2$ ($f_b=28\text{GHz}$)
SDC22, SCD22 < $-18+6*f/f_b$ dB for $f_b/2 < f < f_b$ ($f_b=28\text{GHz}$)
- Ref OIF-CEI-28G-VSR as described in Implementation Agreement OIF-CEI-03.1

Optical Characteristics

Parameter	Symbol	Min.	Typ.	Max.	Unit	Notes
Transmitter						
Data Rate	fDC	25.78125			Gbps	1
Signal speed variation from nominal	Δf_D	-100		+100	ppm	
Transmitter center wavelength	λ_C	1260	1270	1280	nm	
Side Mode Suppression Ratio	SMSR	30			dB	
Average launch power	P _{Tavg}	-2.2		+4.5	dBm	
Optical output power in OMA	OMA	-1.2		+3.5	dBm	
Launch power in OMA minus TDP		-5			dBm	
Transmitter and dispersion penalty (TDP)	TDP			3.5	dB	
Average launch power of OFF transmitter	P _{off}			-30	dBm	
Extinction ratio	ER	3.0			dB	
Transmitter eye mask definition		Figure Below				
Receiver						
Receiver center wavelength	λ_C	1320	1330	1340	nm	
Receiver sensitivity in OMA	P _{minOMA}			-14	dBm	2, 3
Stressed receiver sensitivity in OMA	P _{minSOMA}			-11.5	dBm	2
Average received power	P _{Ravg}			+2.2	dBm	

Notes:

1. Testing by Data Rate; NRZ at 25.78125 Gbps, Mark Ratio 50%, PRBS=2³¹-1
2. For BER 5x10⁻⁵
3. Receiver Sensitivity in OMA is a normative specification.

Mask of Optical Output Eye Diagram

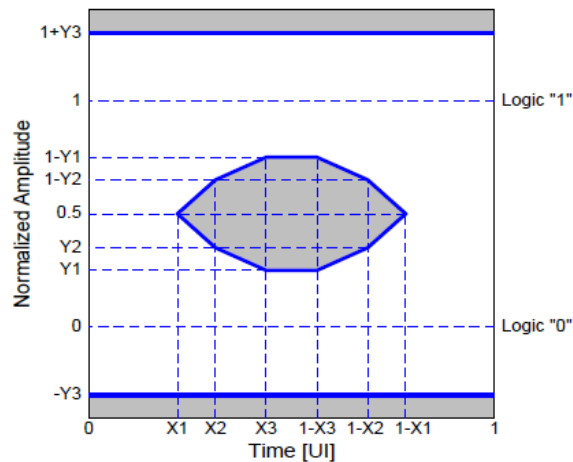

X1	X2	X3	Y1	Y2	Y3	Max Hit Ratio (Note)
0.31	0.4	0.45	0.34	0.38	0.4	5×10^{-5}

Note: The acceptable ratio of samples inside to outside the hatched area (the “hit ratio”) must be met.

Low Speed Control Pin Logic Levels

Parameter	Symbol	Min.	Max.	Unit	Conditions/Notes
Host VCC Range	Host_VCC	3.14	3.47	V	with $\pm 5\%$ variation
TX_Fault, RX_LOS	VOL	0.0	0.40	V	Note 1
	VIL	Host_VCC – 0.5	Host_VCC + 0.3	V	Note 1
TX_Disable	VIL	-0.3	0.8	V	Pulled up with 10k ohms to VccT in the module.
	VIH	2.0	VCC + 0.3	V	

Notes:

1. Rpullup (Rp) is the pull up resistor. Active bus termination may be used by the host in place of a pullup resistor. Pull ups can be connected to multiple power supplies, however the host board design shall ensure that no module pin has voltage exceeding module. Measured at the Host side of the connector.

TX_Fault is a module output pin that when High, indicates that the module transmitter has detected a fault condition related to laser operation or safety. The TX_Fault output pin is an open drain/collector and must be pulled up to the Host_Vcc with 4.7k-10k Ω on the host board

TX_Disable is a module input pin. When TX_Disable is asserted High or left open, the SFP+ module transmitter output must be turned off. The TX_Disable pin is pulled up to VccT with 10k Ω in the SFP+ module. The TX_Disable pin works for TX_fault_Reset as well.

Mod_ABS is pulled up to Host_Vcc with 4.7k-10k Ω on the host board and connected to VeeT or VeeR in the SFP+ module. Mod_ABS is then asserted “High” when the SFP+ module is physically absent from a host slot. In the SFP MSA (INF8074i) this pin had the same function but is called MOD_DEF0.

RX_LOS when high indicates an optical signal level below that specified in the relevant standard. The RX_LOS pin is an open drain/collector output and must be pulled up to host Vcc with a 4.7k-10k Ω on the host board. RX_LOS assert min and de-assert max are defined in the relevant standard.

CDR Control for Bypass Mode

- Default value for “Soft RS0” and “Soft RS1” is ‘0’
- Hard pin#7 for RS0 and hard pin#9 for RS1 are terminated to Ground through 30kohm.

	Hard: Pin #7	Soft: A2h, Byte 110 bit 3	Mode of Operation
RSO	0	0	CDRR bypass mode
	0	1	CDRR engaged mode
	1	0	CDRR engaged mode
	1	1	CDRR engaged mode

	Hard: Pin #9	Soft: A2h, Byte 118 bit 3	Mode of Operation
RS1	0	0	CDRT bypass mode
	0	1	CDRT engaged mode
	1	0	CDRT engaged mode
	1	1	CDRT engaged mode

Pin Description

PIN	Logic	Symbol	Description
1		VEET	Module transmitter ground
2	LVTTTL-O	TX_FAULT	Module transmitter fault
3	LVTTTL-I	TX_DISABLE	Transmitter disable
4	LVTTTL-I/O	SDA	2-wire serial interface data line
5	LVTTTL-I/O	SCL	2-wire serial interface clock
6		MOD_ABS	Module absent (connected to VEET or VEER)
7	LVTTTL-I	RS0	Rate select 0 (Rx) “L”:Bypass, “H”:CDR
8	LVTTTL-O	RX_LOS	Receiver loss of signal
9	LVTTTL-I	RS1	Rate select 1 (Tx) “L”:Bypass, “H”:CDR
10		VEER	Module receiver ground
11		VEER	Module receiver ground
12	CML-O	RD-	Receiver inverted data output
13	CML-O	RD+	Receiver non-inverted data output
14		VEER	Module receiver ground
15		VCCR	Module receiver 3.3 V supply
16		VCCT	Module transmitter 3.3 V supply
17		VEET	Module transmitter ground
18	CML-I	TD+	Transmitter non-inverted data input
19	CML-I	TD-	Transmitter inverted data input
20		VEET	Module transmitter ground

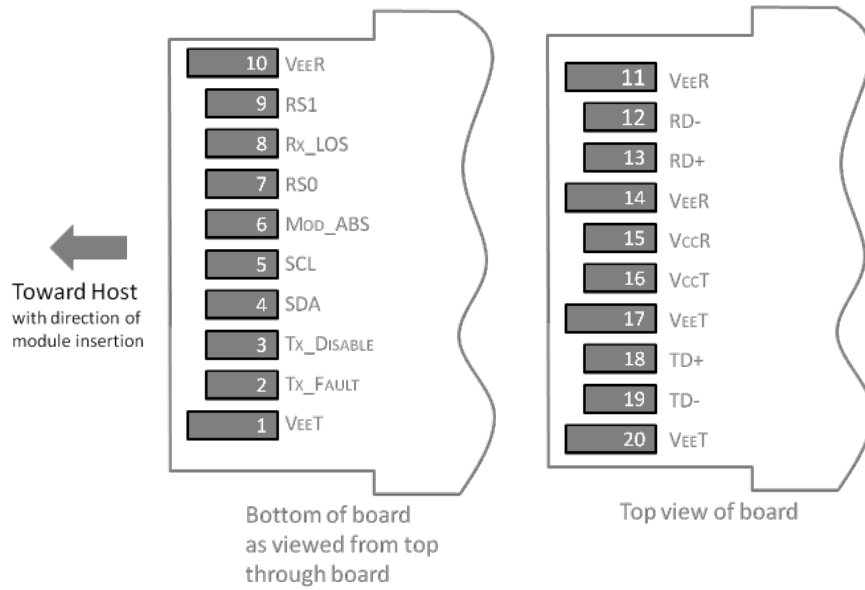

Pin-out of connector Block on Host board

Functional Block Diagram

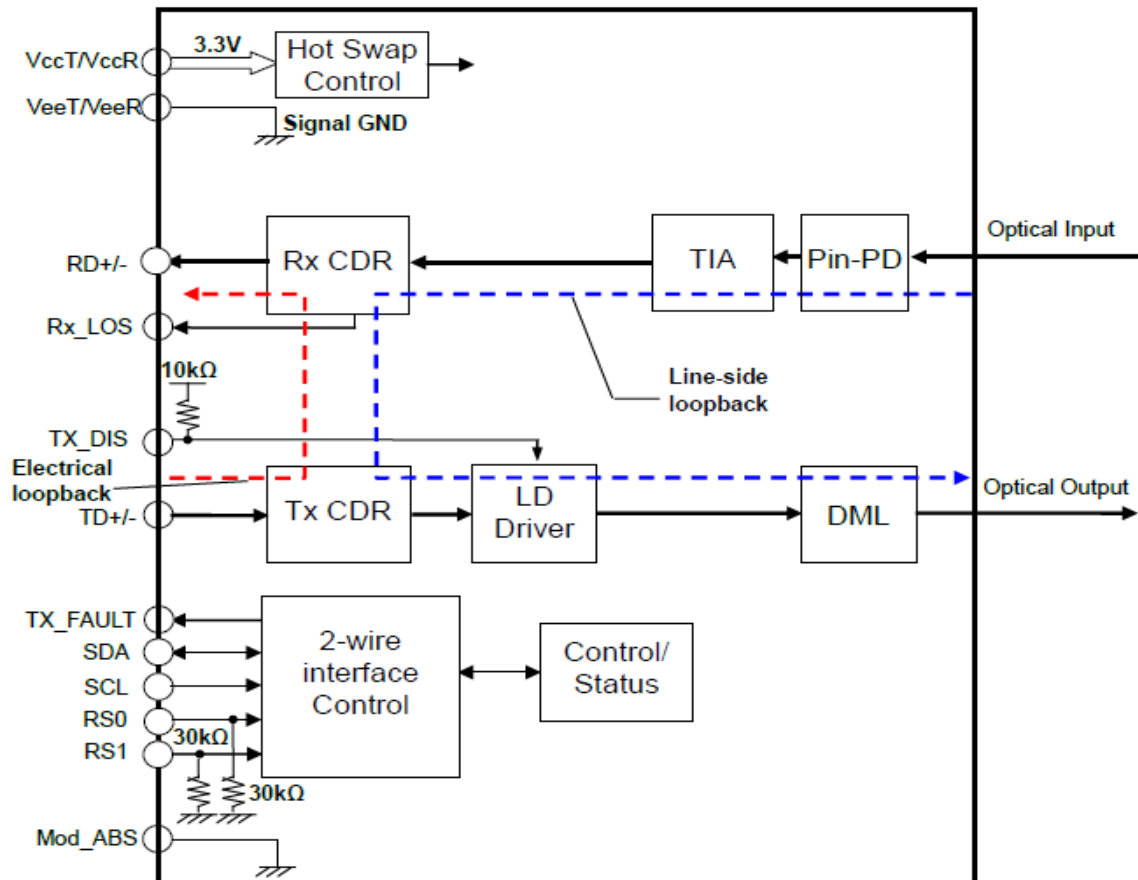

Mechanical Specifications

Unit: mm

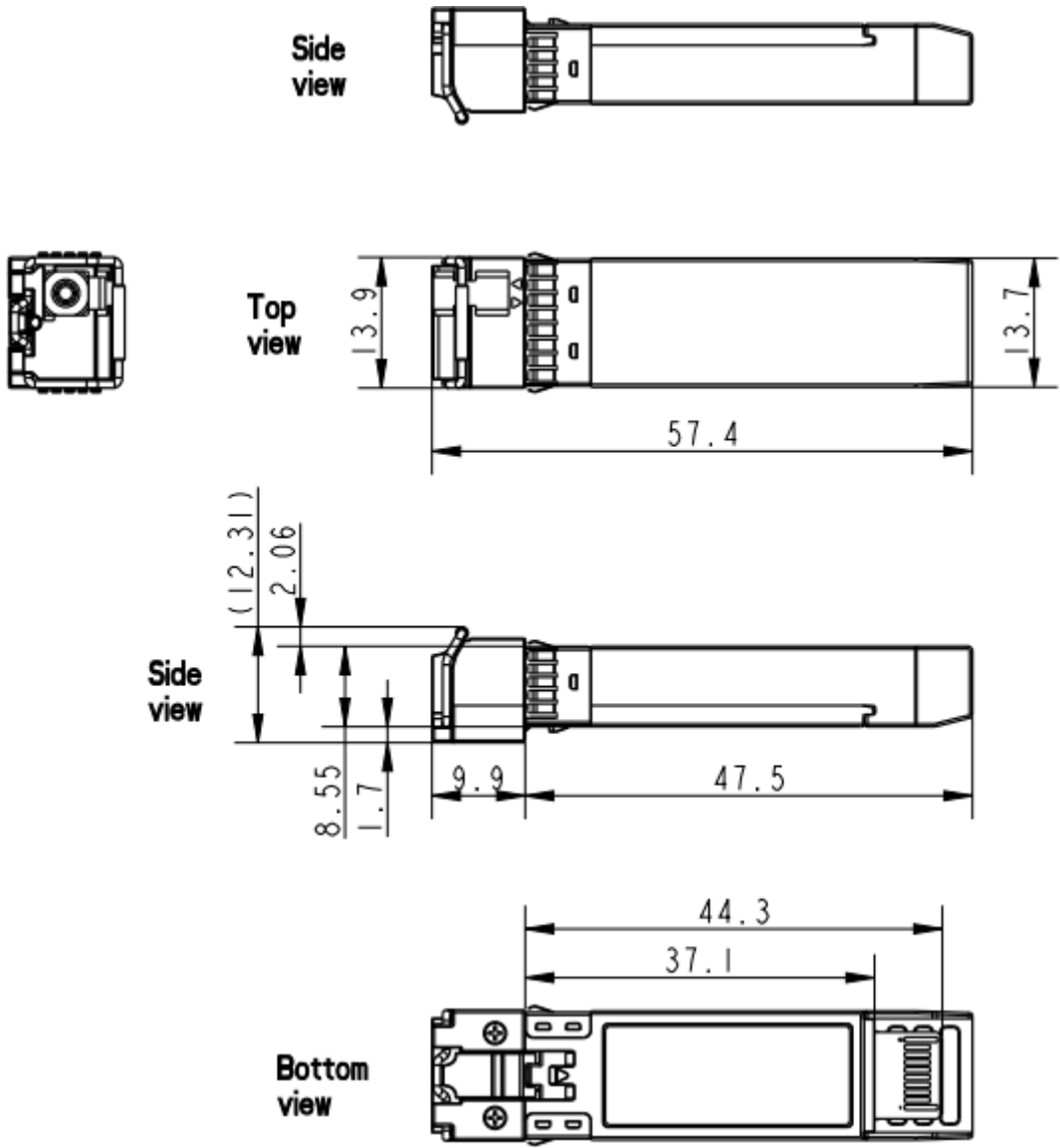

About ProLabs

Our experience comes as standard; for over 15 years ProLabs has delivered optical connectivity solutions that give our customers freedom and choice through our ability to provide seamless interoperability. At the heart of our company is the ability to provide state-of-the-art optical transport and connectivity solutions that are compatible with over 90 optical switching and transport platforms.

Complete Portfolio of Network Solutions

ProLabs is focused on innovations in optical transport and connectivity. The combination of our knowledge of optics and networking equipment enables ProLabs to be your single source for optical transport and connectivity solutions from 100Mb to 400G while providing innovative solutions that increase network efficiency. We provide the optical connectivity expertise that is compatible with and enhances your switching and transport equipment.

Trusted Partner

Customer service is our number one value. ProLabs has invested in people, labs and manufacturing capacity to ensure that you get immediate answers to your questions and compatible product when needed. With Engineering and Manufacturing offices in the U.K. and U.S. augmented by field offices throughout the U.S., U.K. and Asia, ProLabs is able to be our customers best advocate 24 hours a day.

Contact Information

ProLabs US

Email: sales@prolabs.com

Telephone: 952-852-0252

ProLabs UK

Email: salessupport@prolabs.com

Telephone: +44 1285 719 600