

PART NUMBER	SML-LX0805SGC-TR	REV	G
REV	E.C.N. NUMBER AND REVISION COMMENTS	DATE	
A	E.C.N. #10644. & REDRAWN IN 3D.	07.18.00	
B	E.C.N. #10862.	05.09.02	
C	E.C.N. #10967.	03.14.03	
D	E.C.N. #11148.	01.17.05	
E	E.C.N. #11508.	03.06.09	
F	E.C.N. #10BRDR. & REDRAWN.	05.07.12	
G	ECN-Lumex201800100	06.08.18	

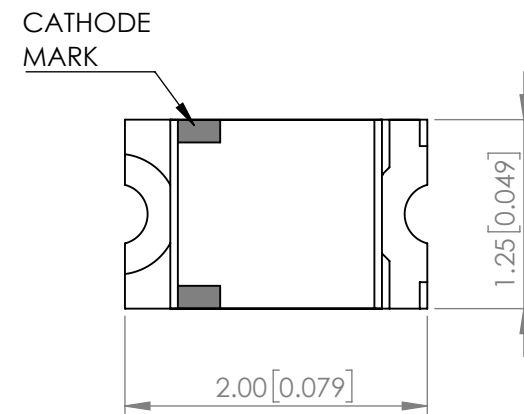

POLARITY

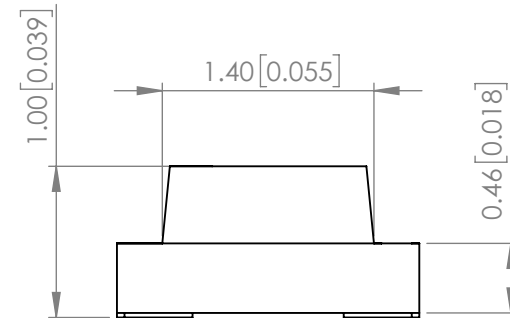
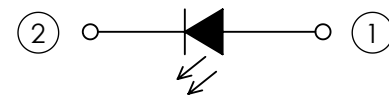

RECOMMENDED SOLDER PAD LAYOUT

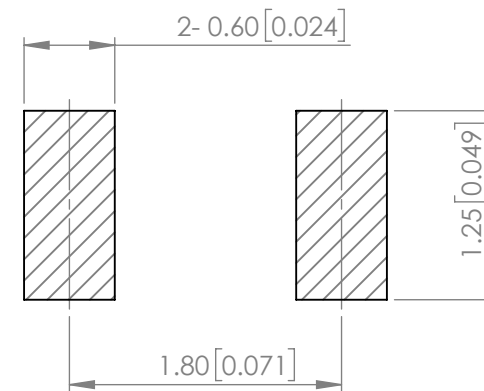
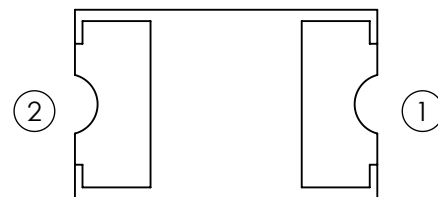

ELECTRO-OPTICAL CHARACTERISTIC TA=25°C

PARAMETER	MIN	TYP	MAX	UNITS	TEST COND
PEAK WAVELENGTH	-	570	-	nm	If=20mA
FORWARD VOLTAGE	-	2.1	2.4	Vf	If=20mA
REVERSE CURRENT	-	-	10	uA	VR=5V
LUMINOUS INTENSITY	-	15	-	mcd	If=20mA
VIEWING ANGLE	-	140	-	2x theta1/2	-
EMITTED COLOR	GREEN				
EPOXY LENS FINISH	WATER CLEAR				

ABSOLUTE MAXIMUM RATINGS TA=25°C

PARAMETER	MAX	UNITS
PEAK FORWARD CURRENT*	60	mA
FORWARD CURRENT	30	mA
REVERSE VOLTAGE	5	V
POWER DISSIPATION	72	mW
STORAGE TEMPERATURE	-40 TO +90	°C
OPERATING TEMPERATURE	-40 TO +85	°C
SOLDERING TEMPERATURE**	3 SEC. MAX @ 260	°C

*t<10us

**2.0mm FROM BODY.

NOTE:

1. RoHS COMPLIANT.
2. COMPLIANCE WITH EU REACH.
3. COMPLIANCE Halogen Free .
(Br <900 ppm ,Cl <900 ppm , Br+Cl < 1500 ppm)

MOISTURE SENSITIVE DEVICE
PER JEDEC LEVEL 3 STANDARDS

*UNLESS OTHERWISE SPECIFIED TOLERANCES PER DECIMAL PRECISION ARE: X=±1 (±0.039), X.X=±0.5 (±0.020), X.XX=±0.25 (±0.010), X.XXX=±0.127 (±0.005). LEAD SIZE=±0.05 (±0.002), LEAD LENGTH=±0.75 (±0.030). MIN= ^{+DECIMAL PRECISION}/_{-0.00} MAX= ^{+0.00}/_{-DECIMAL PRECISION}

<p>425 N. GARY AVE. CAROL STREAM, IL 60188 PHONE : 800-278-5666 FAX : 630-315-2150 WEB : WWW.LUMEX.COM</p>	2.0(L)*1.25(W)*1.0(H)mm, SURFACE MOUNT TOP VIEW LED, GaP 570nm GREEN, WATER CLEAR LENS, TAPE & REEL	DATE : 2018.06.08	DRAWN BY : C.C.	
	THE SPECIFICATIONS MAY CHANGE AT ANY TIME WITHOUT NOTICE DUE TO NEW MATERIALS OR PRODUCT IMPROVEMENT.	PAGE : 1 OF 2	CHKD BY : E.C.	
	CONFIDENTIAL INFORMATION THE INFORMATION CONTAINED IN THIS DOCUMENT IS THE PROPERTY OF LUMEX INC. EXCEPT AS SPECIFICALLY AUTHORIZED IN WRITING BY LUMEX INC., THE HOLDER OF THIS DOCUMENT SHALL KEEP ALL INFORMATION CONTAINED HEREIN CONFIDENTIAL AND SHALL PROTECT SAME IN WHOLE OR IN PART FROM DISCLOSURE AND DISSEMINATION TO ALL THIRD PARTIES.	SCALE : NTF	APRVD BY : G.Y.	
		UNIT : mm [INCH]		

PROFILE

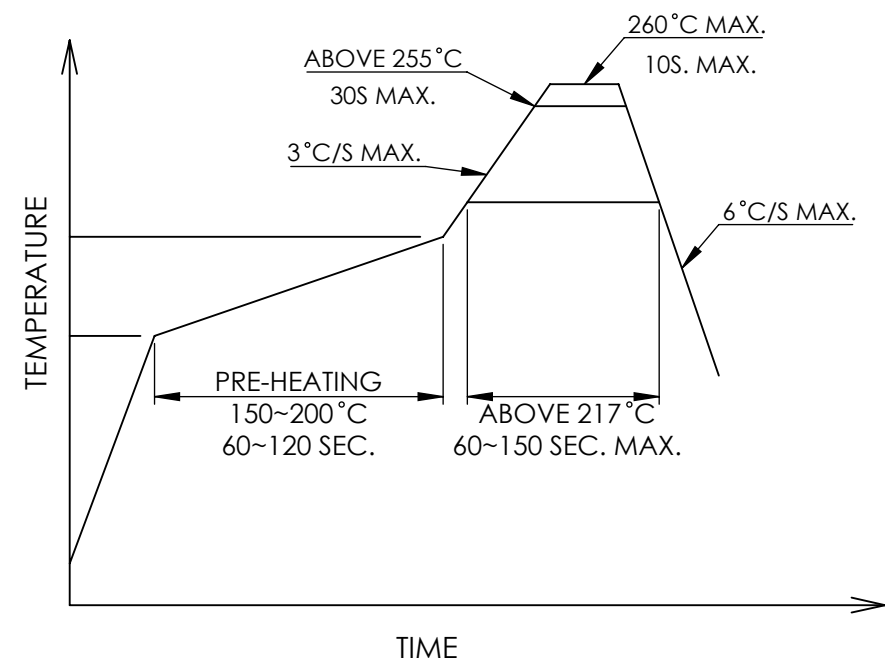

CARRIER TAPE DIMENSION

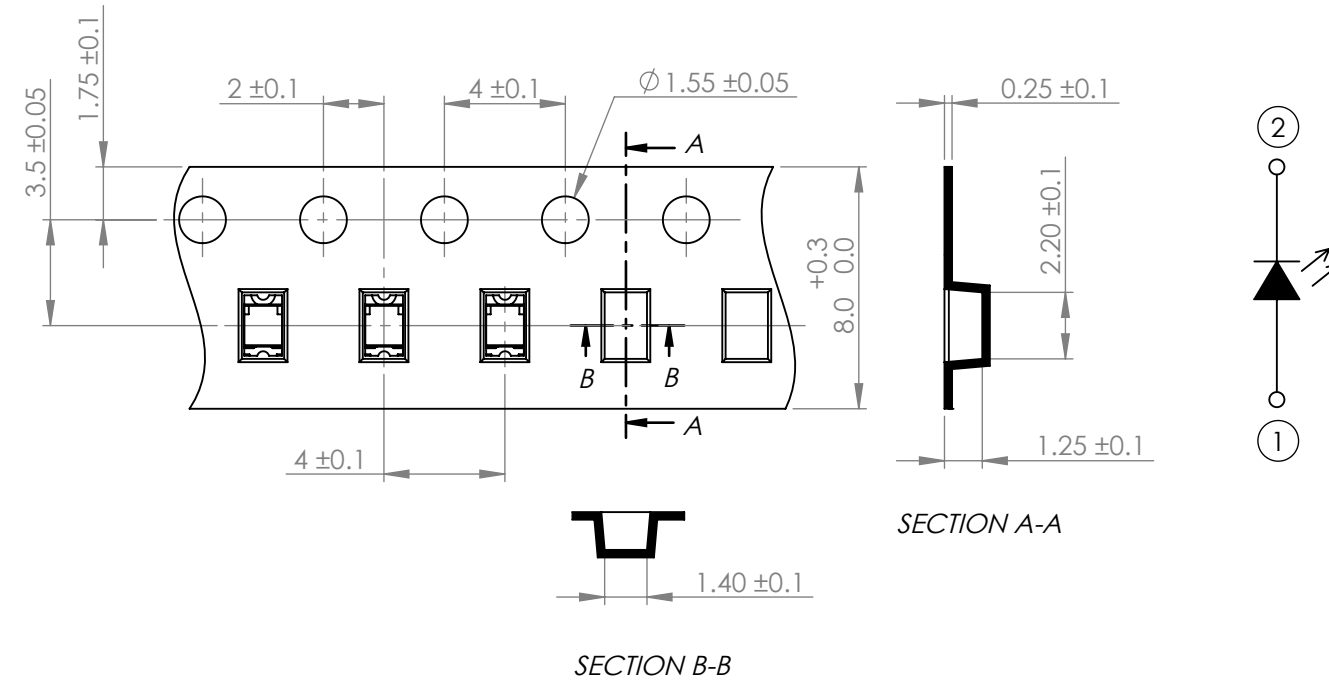

*UNLESS OTHERWISE SPECIFIED TOLERANCES PER DECIMAL PRECISION ARE: X=±1 (±0.039), X.X=±0.5 (±0.020), X.XX=±0.25 (±0.010), X.XXX=±0.127 (±0.005). LEAD SIZE=±0.05 (±0.002), LEAD LENGTH=±0.75 (±0.030). MIN= ^{+DECIMAL PRECISION} / _{-0.00} MAX= ^{+0.00} / _{-DECIMAL PRECISION}

 <p>425 N. GARY AVE. CAROL STREAM, IL 60188 PHONE : 800-278-5666 FAX : 630-315-2150 WEB : WWW.LUMEX.COM</p>	2.0(L)*1.25(W)*1.0(H)mm, SURFACE MOUNT TOP VIEW LED, GaP 570nm GREEN, WATER CLEAR LENS, TAPE & REEL		DATE : 2018.06.08	DRAWN BY : C.C.
	THE SPECIFICATIONS MAY CHANGE AT ANY TIME WITHOUT NOTICE DUE TO NEW MATERIALS OR PRODUCT IMPROVEMENT.		PAGE : 2 OF 2	CHKD BY : E.C.
	CONFIDENTIAL INFORMATION THE INFORMATION CONTAINED IN THIS DOCUMENT IS THE PROPERTY OF LUMEX INC. EXCEPT AS SPECIFICALLY AUTHORIZED IN WRITING BY LUMEX INC., THE HOLDER OF THIS DOCUMENT SHALL KEEP ALL INFORMATION CONTAINED HEREIN CONFIDENTIAL AND SHALL PROTECT SAME IN WHOLE OR IN PART FROM DISCLOSURE AND DISSEMINATION TO ALL THIRD PARTIES.		SCALE : NTF	APRVD BY : G.Y.
			UNIT : mm [INCH]	(No)