

DATA SHEET

SKY65162-70LF: 400 to 3800 MHz Linear Power Amplifier

Applications

- UHF television
- TETRA radios
- PCS, DCS, 2.5G, 3G, 4G handsets and infrastructure systems
- ISM band transmitters
- WCS fixed wireless
- 802.16 WiMAX
- 3GPP LTE

Features

- Wideband frequency range: 400 to 3800 MHz
- Low noise figure: 3.6 dB
- High OIP3
- OP1dB = +29.5 dBm @ 1960 MHz
- High gain: 24 dB
- On-chip bias circuit
- SOT-89 (4-pin, 2.4 x 4.5 mm) package (MSL1, 260 °C per JEDEC J-STD-020)



Skyworks Green™ products are compliant with all applicable legislation and are halogen-free. For additional information, refer to *Skyworks Definition of Green™*, document number SQ04-0074.

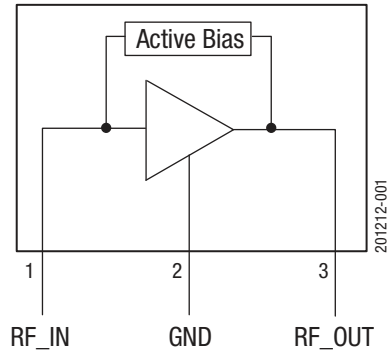

Figure 1. SKY65162-70LF Functional Block Diagram

Description

Skyworks SKY65162-70LF is a high-performance, ultra-wideband power amplifier (PA) with superior output power, low noise, high linearity, and high efficiency. The device provides excellent linearity with a 1 dB output compression point (OP1dB) of +29.5 dBm at 1960 MHz, making the SKY65162-70LF ideal for use in the driver stage of infrastructure transmit chains.

The SKY65162-70LF uses low-cost surface-mount technology (SMT) in the form of a 4-pin, 2.4 x 4.5 mm small outline transistor (SOT-89) package. A functional block diagram is provided in Figure 1. The device package and pinout are shown in Figure 2. Signal pin assignments and functional pin descriptions are described in Table 1.

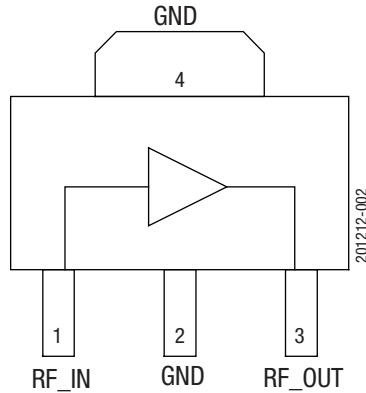

Figure 2. SKY65162-70LF Pinout Package (Top View)

Table 1. SKY65162-70LF Signal Descriptions

Pin	Name	Description
1	RF_IN	RF input
2	GND	Ground
3	RF_OUT	RF output
4	GND	Ground

Technical Description

The SKY65162-70LF is a single-stage, linear PA that operates with a single 5 V power supply connected through an RF choke (inductor L2) to the output signal (pin 3). The bias current is set by the on-chip active bias composed of current mirror and reference voltage transistors, which allow excellent gain tracking over temperature and voltage variations. The device is externally RF matched using surface-mount components to facilitate operation over a frequency range of 400 to 3800 MHz.

Electrical and Mechanical Specifications

The absolute maximum ratings of the SKY65162-70LF are provided in Table 2. The recommended operating conditions are specified in Table 3 and electrical specifications are provided in Tables 4 through 10.

Typical performance characteristics of the SKY65162-70LF are illustrated in Figures 3 through 17 (915 MHz), Figures 18 through 34 (1960 MHz), Figures 35 through 49 (2100 MHz), Figures 50 through 67 (2400 MHz), Figures 68 through 71 (2600 MHz), and Figures 72 through 82 (3600 MHz).

Table 2. SKY65162-70LF Absolute Maximum Ratings¹

Parameter	Symbol	Minimum	Maximum	Units
Supply voltage	VCC		6	V
RF output power	P _{OUT}		+30	dBm
Supply current	I _{CC}		400	mA
Operating case temperature	T _C	-40	+85	°C
Storage temperature	T _{ST}	-55	+125	°C
Junction temperature	T _J		+150	°C
Thermal resistance	Θ _{JC}		29	°C/W

¹ Exposure to maximum rating conditions for extended periods may reduce device reliability. There is no damage to device with only one parameter set at the limit and all other parameters set at or below their nominal values. Exceeding any of the limits listed here may result in permanent damage to the device.

ESD HANDLING: Although this device is designed to be as robust as possible, electrostatic discharge (ESD) can damage this device. This device must be protected at all times from ESD when handling or transporting. Static charges may easily produce potentials of several kilovolts on the human body or equipment, which can discharge without detection. Industry-standard ESD handling precautions should be used at all times.

Table 3. SKY65162-70LF Recommended Operating Conditions

Parameter	Symbol	Min	Typ	Max	Units
Supply voltage	VCC	4.75	5.0	5.5	V
Operating frequency	f	400		3800	MHz
Operating case temperature	T _J	-40	+25	+85	°C

**Table 4. SKY65162-70LF Electrical Characteristics¹
(VCC = +5 V, T_C = 25 °C, f = 430 MHz, Unless Otherwise Noted)**

Parameter	Symbol	Test Conditions	Min	Typ	Max	Units
Frequency	f		400		470	MHz
Small signal gain	IS21I	Small signal	23.0	23.5		dB
Input return loss	IS11I	Small signal	14	17		dB
Output return loss	IS22I	Small signal	16	24		dB
Third order output intercept point	OIP3	P _{OUT} = +10 dBm	+37	+40		dBm
Noise figure	NF			10	12	dB
1 dB output compression point	OP1dB	CW	+28	+29		dBm
Adjacent channel power ratio	ACPR1	@ P _{OUT} = +14 dBm (CDMA 2000)		-61	-60	dBc
Quiescent current	I _{CC}	No RF		180	210	mA

¹ Performance shown in this table is verified by characterization and is not guaranteed by production test.

Table 5. SKY65162-70LF Electrical Characteristics¹
(VCC = +5 V, Tc = 25 °C, f = 915 MHz, Unless Otherwise Noted)

Parameter	Symbol	Test Conditions	Min	Typ	Max	Units
Frequency	f		869		960	MHz
Small signal gain	IS21I	Small signal	19.5	20.0		dB
Input return loss	IS11I	Small signal	21	29		dB
Output return loss	IS22I	Small signal	9	10		dB
Third order output intercept point	OIP3	POUT = +10 dBm	+40	+42		dBm
Noise figure	NF			4.0	4.5	dB
1 dB output compression point	OP1dB	CW	+28.0	+28.5		dBm
Saturated output power	PSAT	VCC = 5 V		+30.5		dBm
		VCC = 4 V		+29.0		dBm
Operational current	IOP	@ P1dB = +28.8 dBm		306		mA
Quiescent current	ICQ	No RF		180	210	mA

¹ Performance shown in this table is verified by characterization and is not guaranteed by production test.

Typical Performance Characteristics
 (VCC = +5 V, Tc = 25 °C, f = 915 MHz, Unless Otherwise Noted)

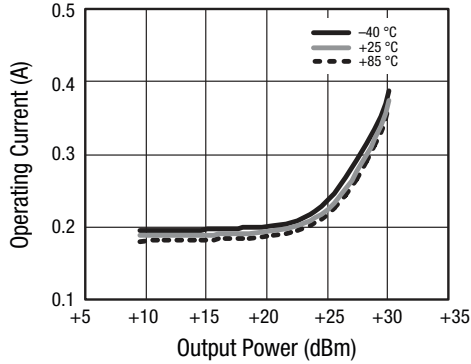

Figure 3. Operating Current vs Output Power Over Temperature

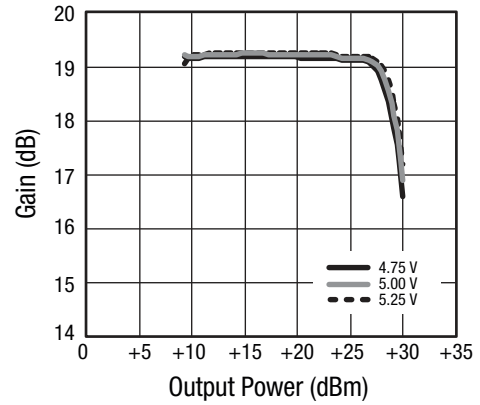

Figure 4. Gain vs Output Power Over Voltage

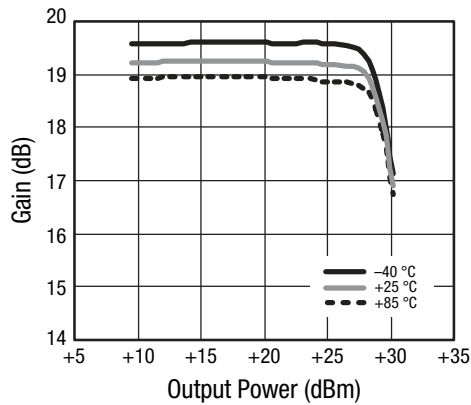

Figure 5. Gain vs Output Power Over Temperature

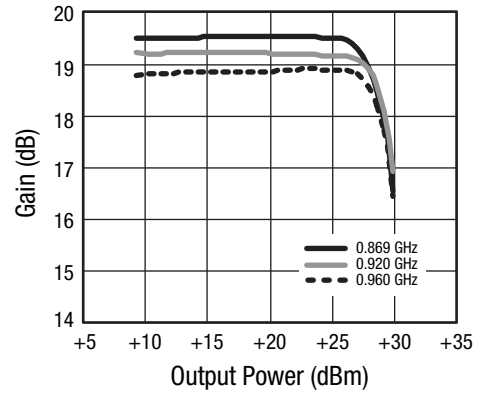

Figure 6. Gain vs Output Power Over Frequency

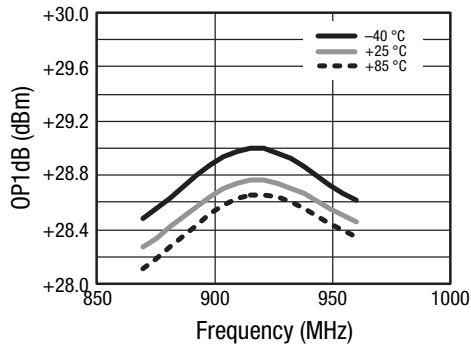

Figure 7. OP1dB vs Frequency Over Temperature

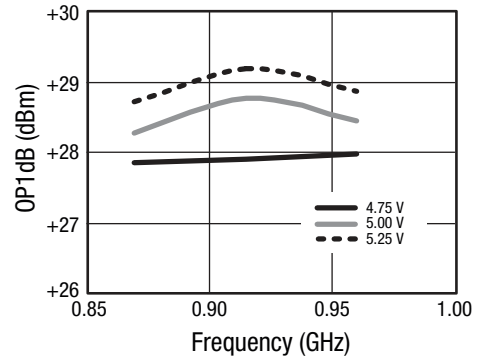

Figure 8. OP1dB vs Frequency Over Voltage

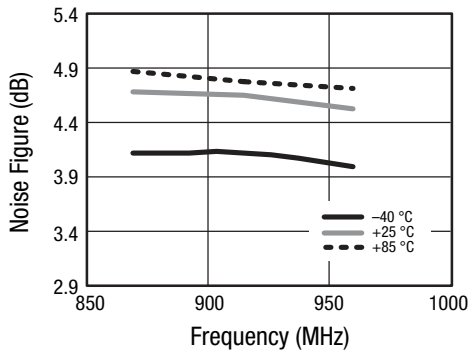

Figure 9. Noise Figure vs Frequency Over Temperature

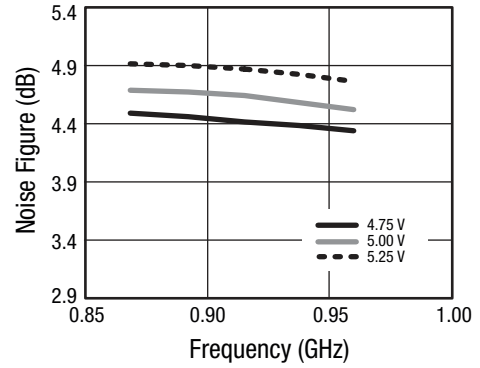

Figure 10. Noise Figure vs Frequency Over Voltage

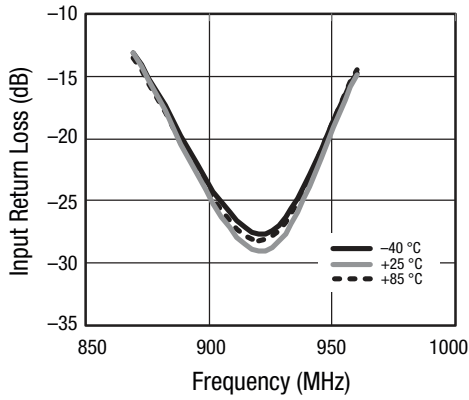

Figure 11. Input Return Loss vs Frequency Over Temperature

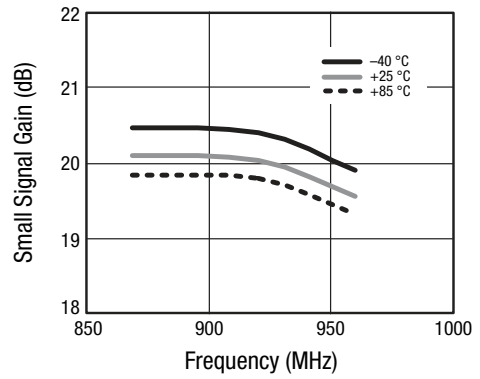

Figure 12. Small Signal Gain vs Frequency Over Temperature

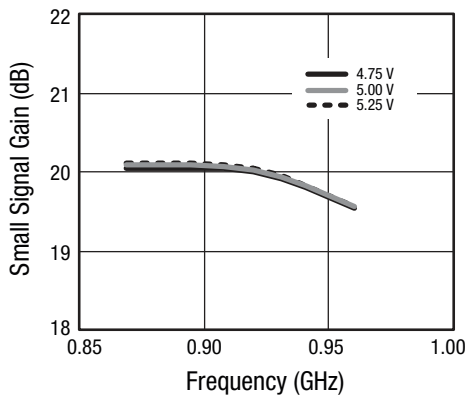

Figure 13. Small Signal Gain vs Frequency Over Voltage

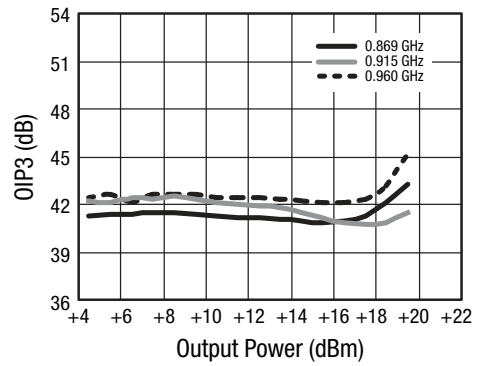

Figure 14. OIP3 vs Output Power Over Frequency

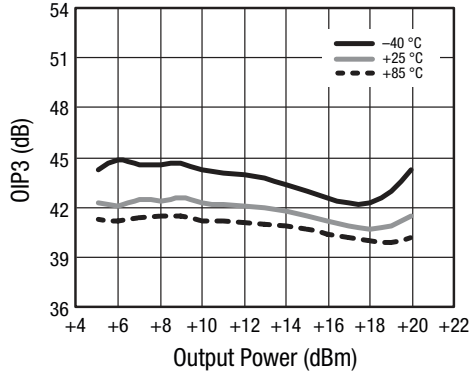

Figure 15. OIP3 vs Output Power Over Temperature

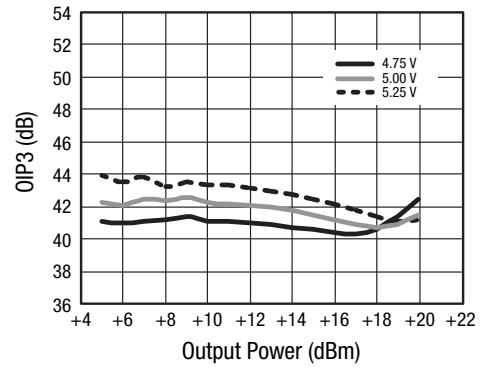

Figure 16. OIP3 vs Output Power Over Voltage

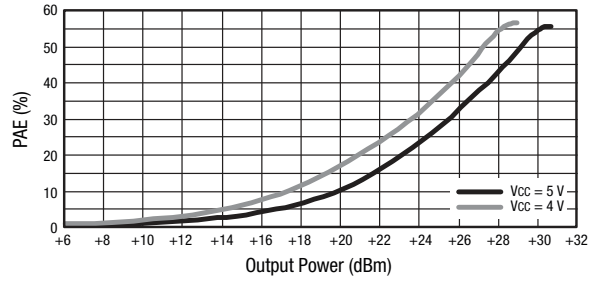

Figure 17. Output Power vs PAE Over Voltage

Table 6. SKY65162-70LF Electrical Characteristics¹
(VCC = +5 V, Tc = 25 °C, f = 1960 MHz, Unless Otherwise Noted)

Parameter	Symbol	Test Conditions	Min	Typ	Max	Units
Frequency	f		1930		1990	MHz
Small signal gain	IS21I	Small signal	14.5	15.0		dB
Input return loss ²	IS11I	Small signal	15	20		dB
Output return loss ²	IS22I	Small signal	15	20		dB
1 dB output compression point	OP1dB	CW	+28.0	+29.5		dBm
Third order output intercept point	OIP3	P _{IN} = -5 dBm/tone	+40.0	+43.0		dBm
Noise figure	NF			3.8	4.5	dB
Operating current	I _{OP}	@ P1dB		340	400	mA
Quiescent current	I _{CO}	No RF		180	210	mA

¹ Performance is guaranteed only under the conditions listed in this table.

² Verified by characterization; not tested in production.

Typical Performance Characteristics

(VCC = +5 V, Tc = 25 °C, f = 1960 MHz, Unless Otherwise Noted)

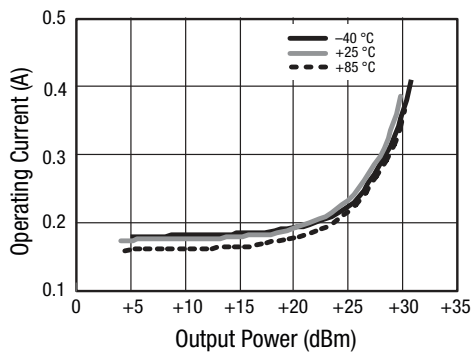

Figure 18. Operating Current vs Output Power Over Temperature

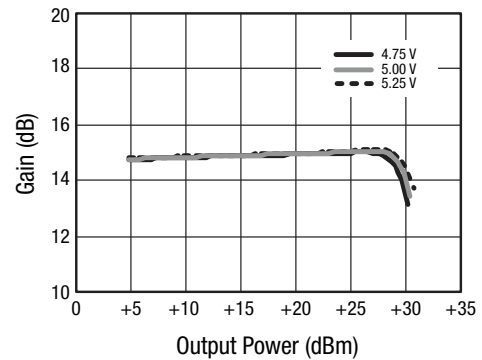

Figure 19. Gain vs Output Power Over Voltage

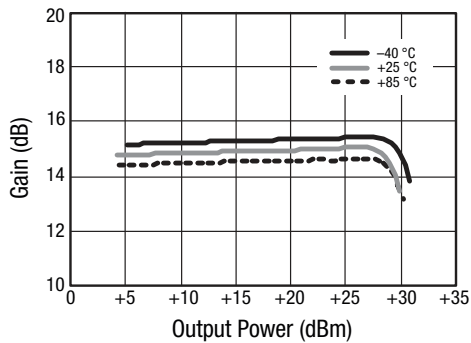

Figure 20. Gain vs Output Power Over Temperature

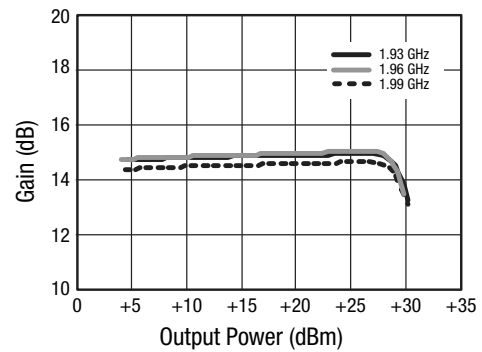

Figure 21. Gain vs Output Power Over Frequency

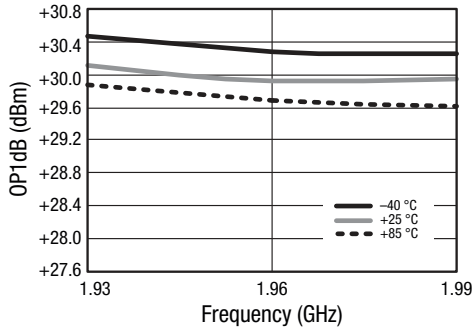

Figure 22. OP1dB vs Frequency Over Temperature

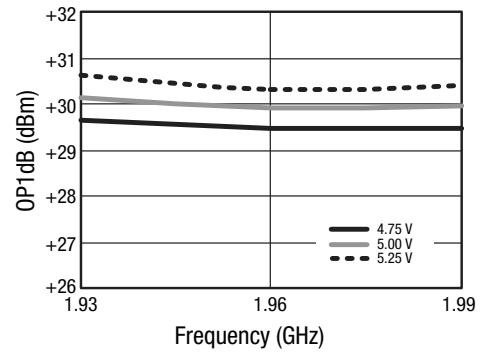

Figure 23. OP1dB vs Frequency Over Voltage

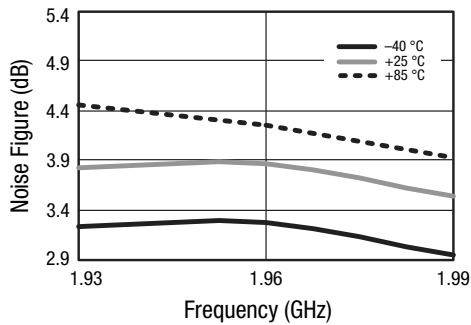

Figure 24. Noise Figure vs Frequency Over Temperature

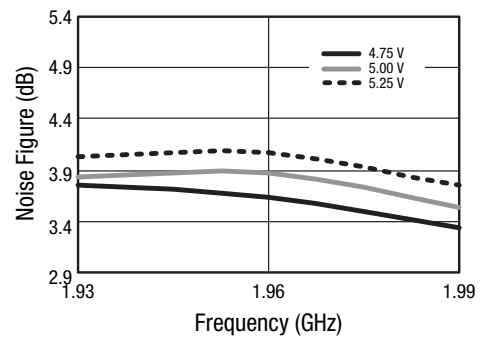

Figure 25. Noise Figure vs Frequency Over Voltage

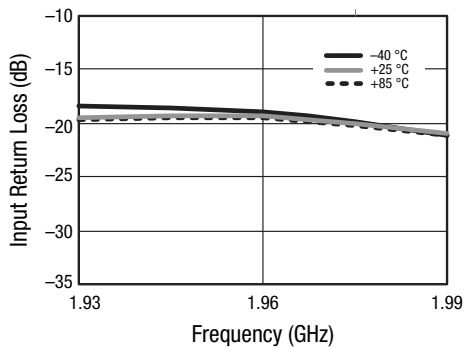

Figure 26. Input Return Loss vs Frequency Over Temperature

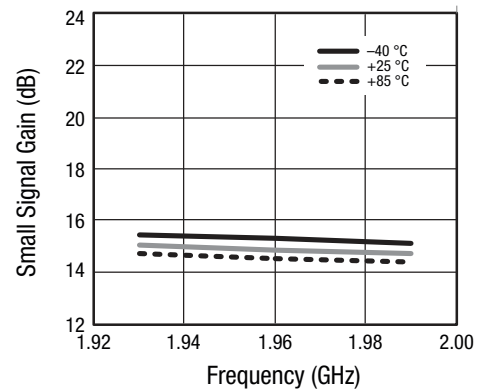

Figure 27. Small Signal Gain vs Frequency Over Temperature

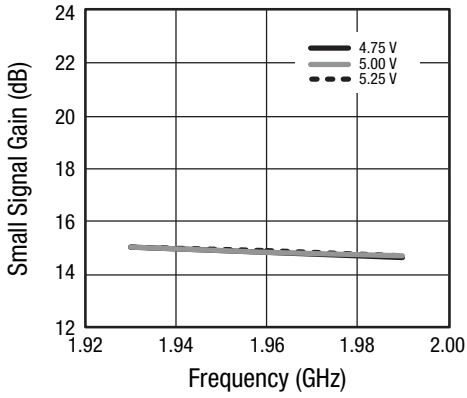

Figure 28. Small Signal Gain vs Frequency Over Voltage

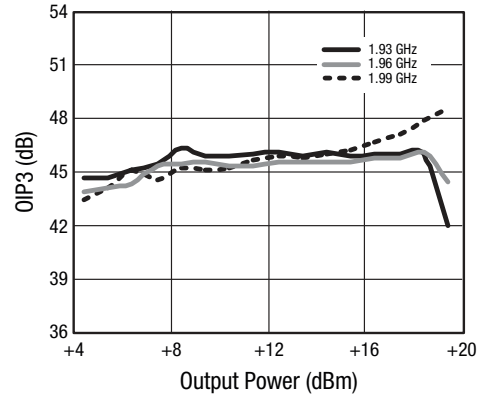

Figure 29. OIP3 vs Output Power Over Frequency

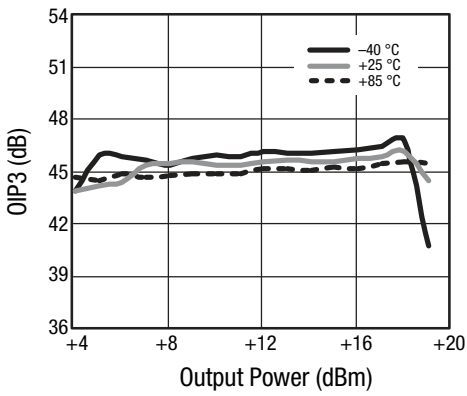

Figure 30. OIP3 vs Output Power Over Temperature

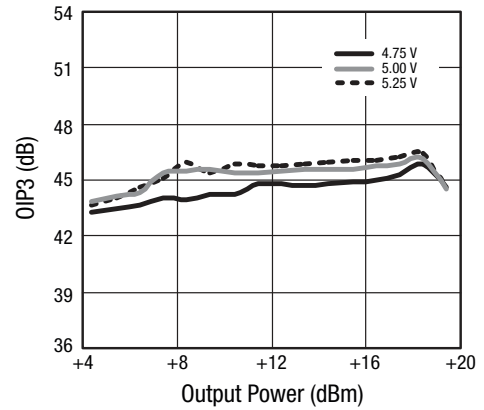

Figure 31. OIP3 vs Output Power Over Voltage

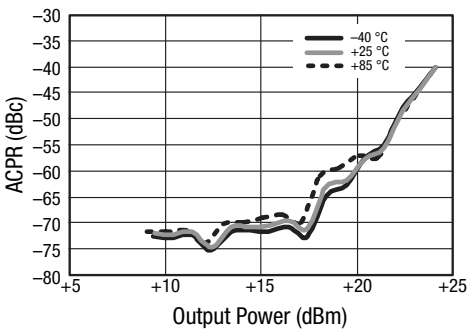

Figure 32. ACPR vs Output Power Over Temperature

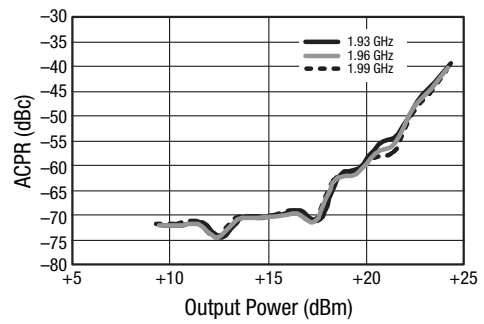

Figure 33. ACPR vs Output Power Over Frequency

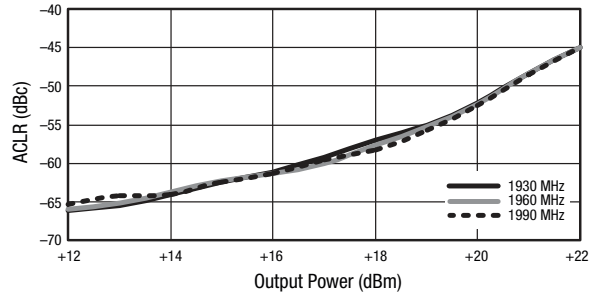

Figure 34. ACLR vs Output Power Over Frequency (WCDMA 3GPP, Test Model 1, 64 DPCH)

Table 7. SKY65162-70LF Electrical Characteristics¹
(VCC = +5 V, Tc = 25 °C, f = 2100 MHz, Unless Otherwise Noted)

Parameter	Symbol	Test Conditions	Min	Typ	Max	Units
Frequency	f		2110		2170	MHz
Small signal gain	IS211	Small signal	14.0	14.3		dB
Input return loss	IS111	Small signal	10	17		dB
Output return loss	IS221	Small signal	10	20		dB
1 dB output compression point	OP1dB	CW	+28.5	+29.0		dBm
Third order output intercept point	OIP3	P _{OUT} = +10 dBm	+42.0	+43.5		dBm
Noise figure	NF			4.6	5.0	dB
Operational current	I _{OP}	@ P1dB = +29.5 dBm		375	400	mA
Quiescent current	I _{CO}	No RF		180	210	mA

¹ Performance shown in this table is verified by characterization and is not guaranteed by production test.

Typical Performance Characteristics
(VCC = +5 V, Tc = 25 °C, f = 2100 MHz, Unless Otherwise Noted)

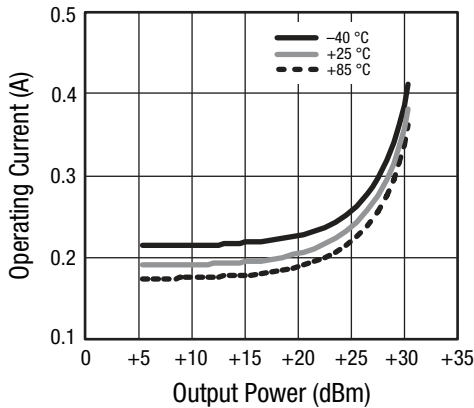

Figure 35. Operating Current vs Output Power Over Temperature

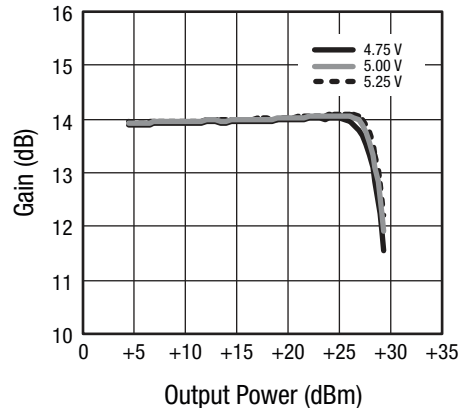

Figure 36. Gain vs Output Power Over Voltage

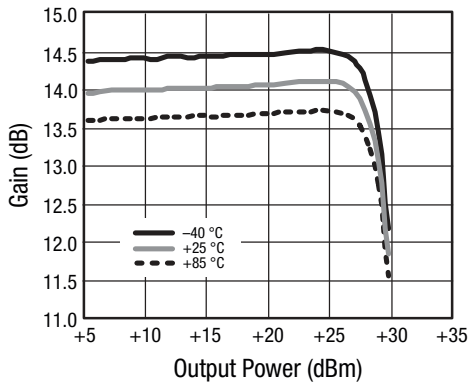

Figure 37. Gain vs Output Power Over Temperature

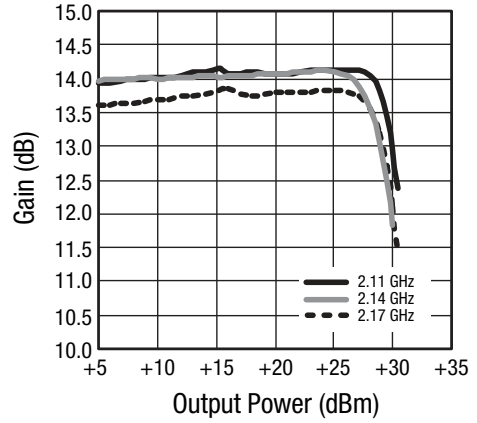

Figure 38. Gain vs Output Power Over Frequency

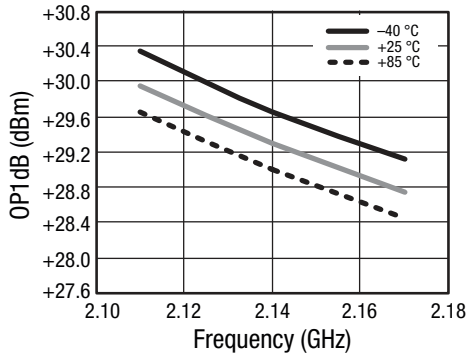

Figure 39. OP1dB vs Frequency Over Temperature

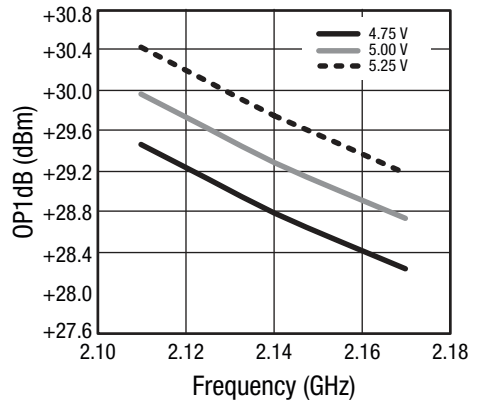

Figure 40. OP1dB vs Frequency Over Voltage

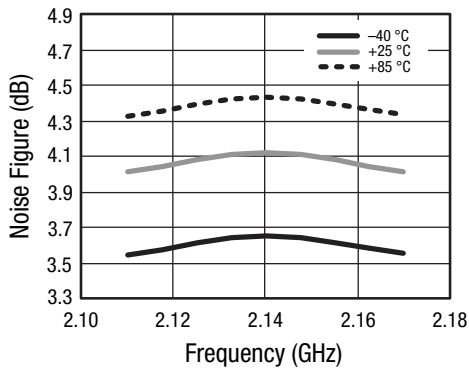

Figure 41. Noise Figure vs Frequency Over Temperature

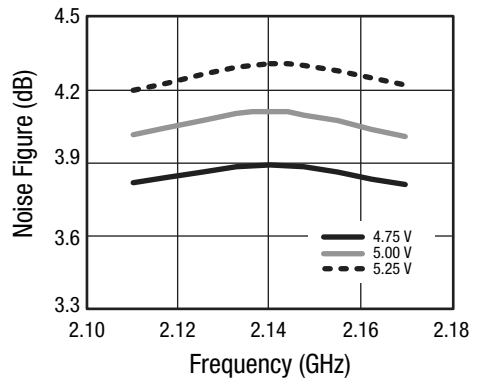

Figure 42. Noise Figure vs Frequency Over Voltage

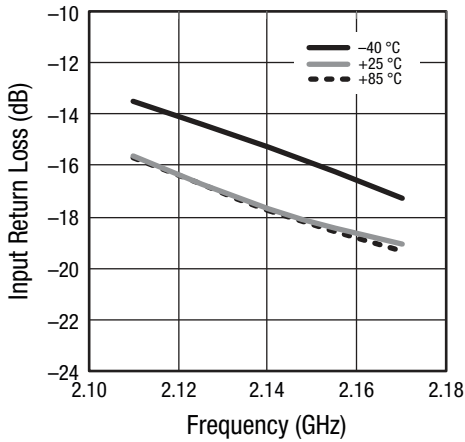

Figure 43. Input Return Loss vs Frequency Over Temperature

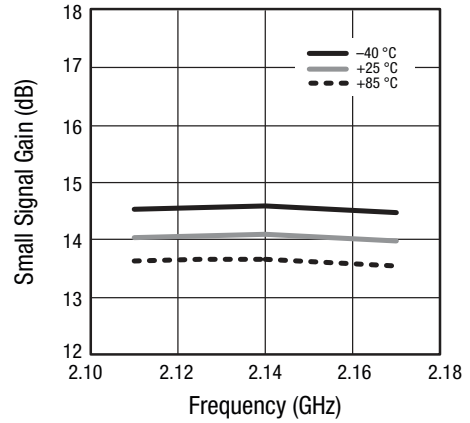

Figure 44. Small Signal Gain vs Frequency Over Temperature

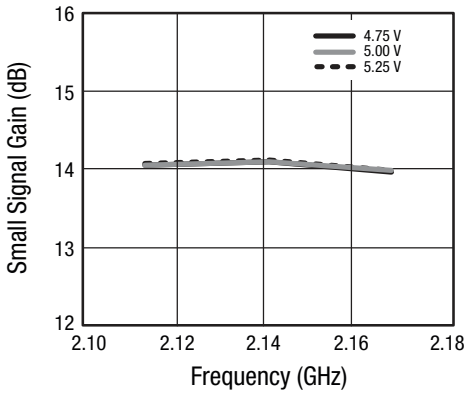

Figure 45. Small Signal Gain vs Frequency Over Voltage

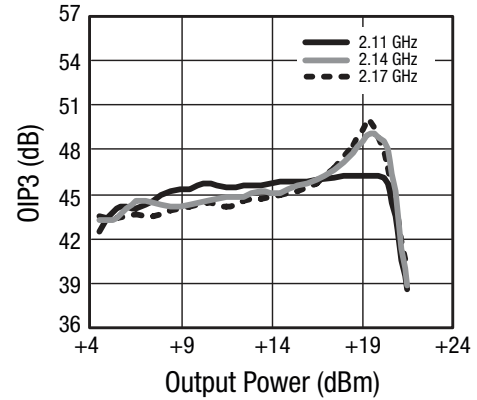

Figure 46. OIP3 vs Output Power Over Frequency

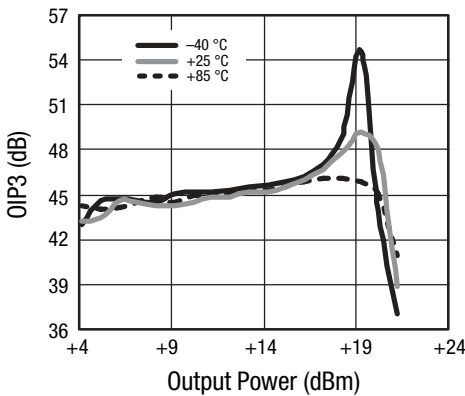

Figure 47. OIP3 vs Output Power Over Temperature

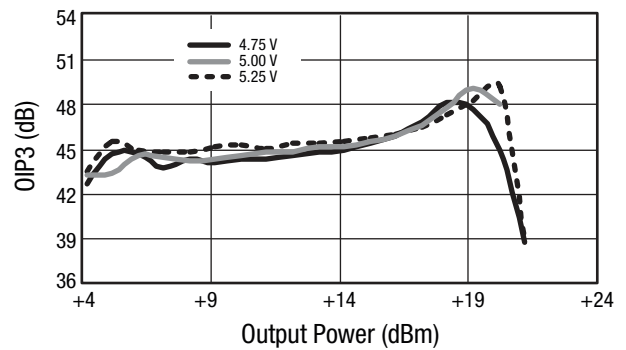

Figure 48. OIP3 vs Output Power Over Voltage

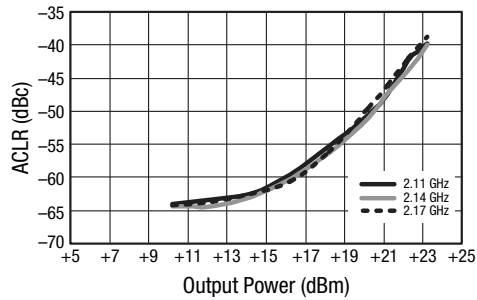

Figure 49. ACLR vs Output Power Over Frequency

Table 8. SKY65162-70LF Electrical Characteristics¹
(VCC = +5 V, Tc = 25 °C, f = 2400 MHz, Unless Otherwise Noted)

Parameter	Symbol	Test Conditions	Min	Typ	Max	Units
Frequency	f		2300		2500	MHz
Small signal gain	IS21	Small signal	12.5	13.0		dB
Input return loss	IS11	Small signal	17	20		dB
Output return loss	IS22	Small signal	15	20		dB
Reverse transmission loss	IS12	Small signal	17	21		dB
1 dB output compression point	OP1dB	CW	+29.0	+29.5		dBm
Third order output intercept point	OIP3		+44	+45		dBm
Output power	POUT	802.11g, 64 QAM, 54 Mbps, 3% EVM		+22		dBm
Noise figure	NF			4.4	5.0	dB
Operational current	IOp	@ P1dB = +30 dBm		401	480	mA
Quiescent current	ICQ	No RF		180	210	mA

¹ Performance shown in this table is verified by characterization and is not guaranteed by production test.

Typical Performance Characteristics
(VCC = +5 V, Tc = 25 °C, f = 2400 MHz, Unless Otherwise Noted)

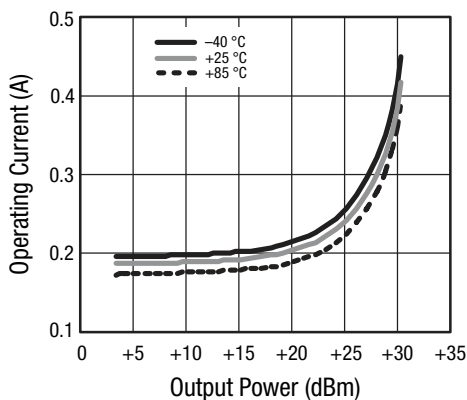

Figure 50. Operating Current vs Output Power Over Temperature

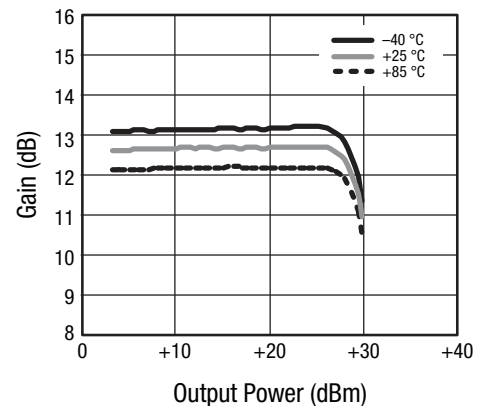

Figure 51. Gain vs Output Power Over Temperature

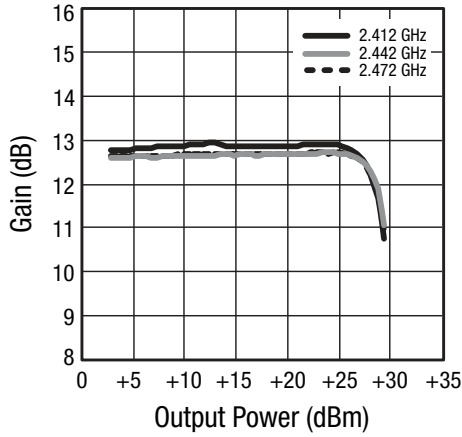

Figure 52. Gain vs Output Power Over Frequency

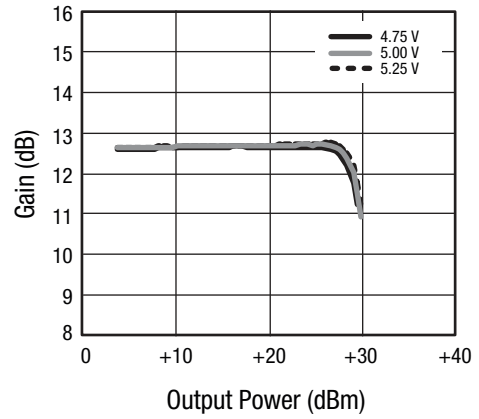

Figure 53. Gain vs Output Power Over Voltage

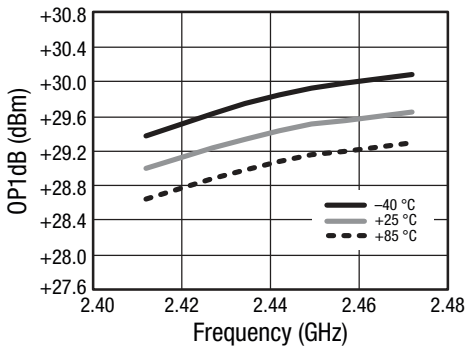

Figure 54. OP1dB vs Frequency Over Temperature

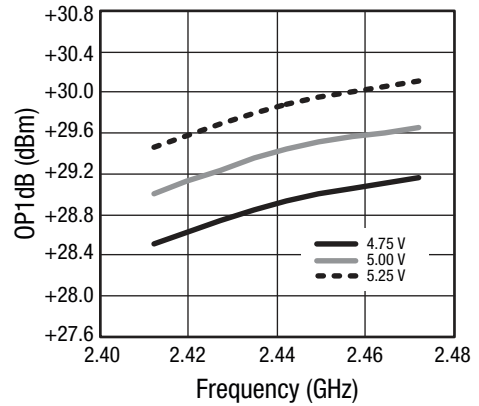

Figure 55. OP1dB vs Frequency Over Voltage

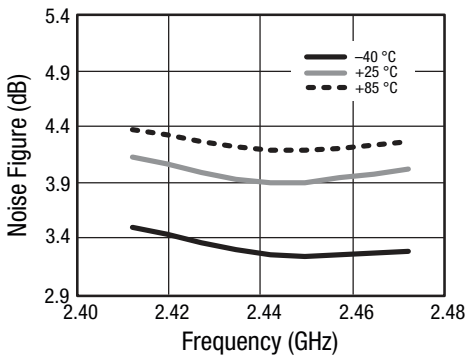

Figure 56. Noise Figure vs Frequency Over Temperature

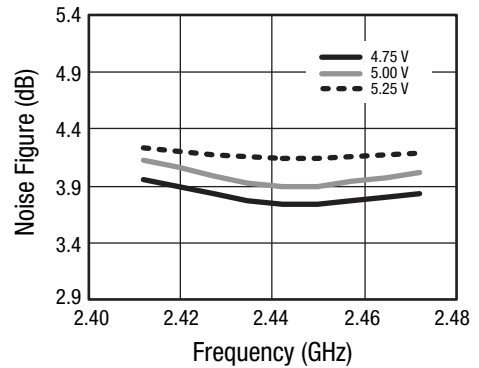

Figure 57. Noise Figure vs Frequency Over Voltage

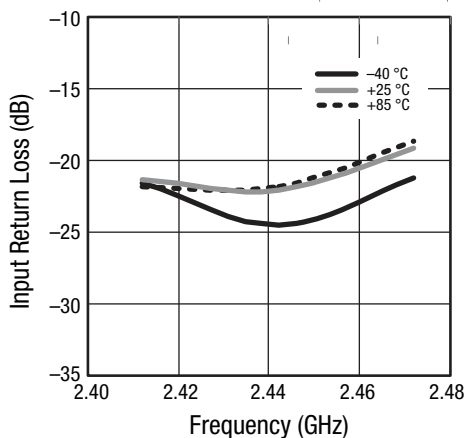

Figure 58. Input Return Loss vs Frequency Over Temperature

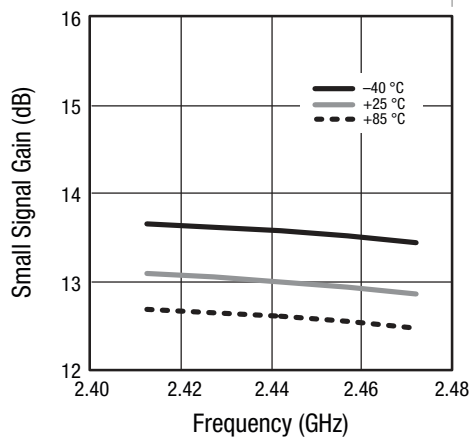

Figure 59. Small Signal Gain vs Frequency Over Temperature

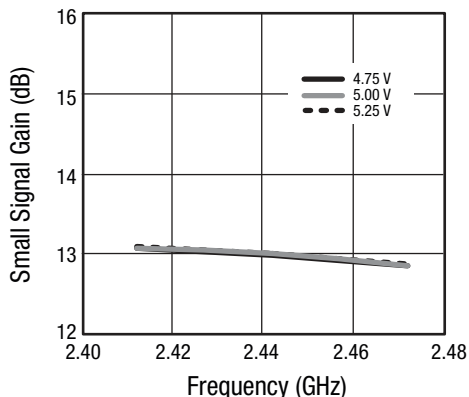

Figure 60. Small Signal Gain vs Frequency Over Voltage

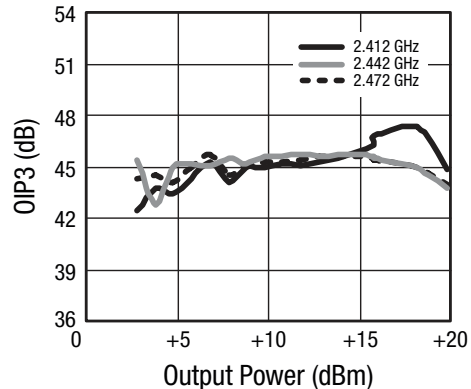

Figure 61. OIP3 vs Output Power Over Frequency

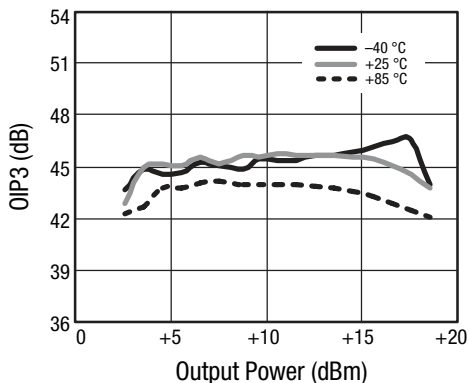

Figure 62. OIP3 vs Output Power Over Temperature

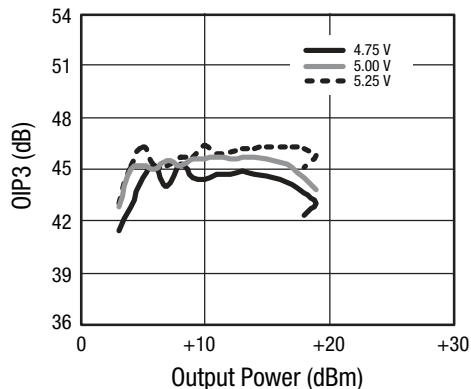

Figure 63. OIP3 vs Output Power Over Voltage

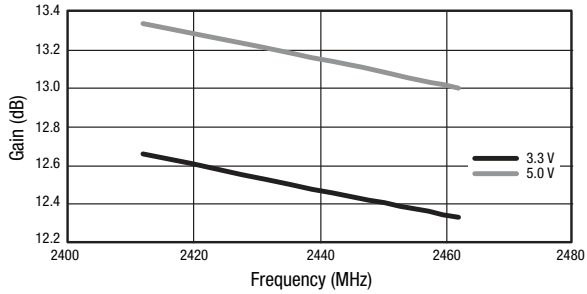

Figure 64. Gain vs Frequency Over Voltage (802.11g, 64 QAM, 54 Mbps, OFDM)

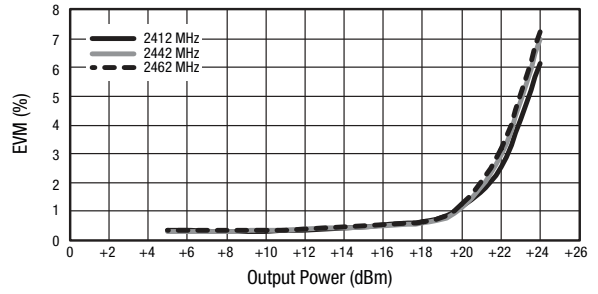

Figure 65. EVM vs Output Power Over Frequency (802.11g, 64 QAM, 54 Mbps, OFDM)

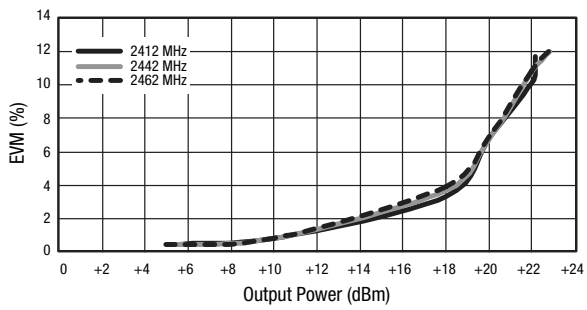

Figure 66. EVM vs Output Power Over Frequency (802.11g, 64 QAM, 54 Mbps, OFDM, Vcc = 3.3 V)

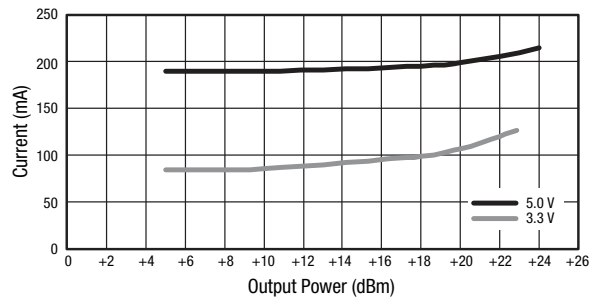

Figure 67. Operating Current vs Output Power Over Voltage (802.11g, 64 QAM, 54 Mbps, OFDM)

Table 9. SKY65162-70LF Electrical Characteristics¹
(VCC = +5 V, Tc = 25 °C, f = 2600 MHz, Unless Otherwise Noted)

Parameter	Symbol	Test Conditions	Min	Typ	Max	Units
Frequency	f		2500	2600	2700	MHz
Small signal gain	S ₂₁	Small signal		12.7		dB
Input return loss	S ₁₁	Small signal		17		dB
Output return loss	S ₂₂	Small signal		22		dB
Reverse transmission loss	S ₁₂	Small signal		25		dB
1 dB output compression point	OP1dB	CW		+29.6		dBm
Saturated output power	P _{SAT}			+30.4		dBm
Saturation current	I _{SAT}	@ P _{SAT} = +30.4 dBm		428		mA
Third order output intercept point	OIP3	P _{OUT} = +5 dBm		+44		dBm
Noise figure	NF			3.8		dB
Operating current	I _{OP}	@ P1 dB = +29.6 dBm		330		mA
Quiescent current	I _Q	No RF		180	210	mA

¹ Performance shown in this table is verified by characterization and is not guaranteed by production test.

Typical Performance Characteristics

(VCC = +5 V, Tc = 25 °C, f = 2600 MHz, Unless Otherwise Noted)

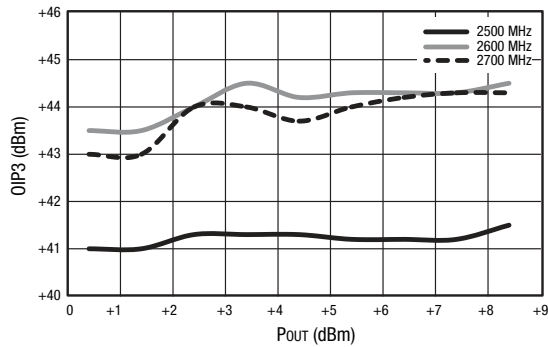

Figure 68. OIP3 vs Pout @ 2700 MHz

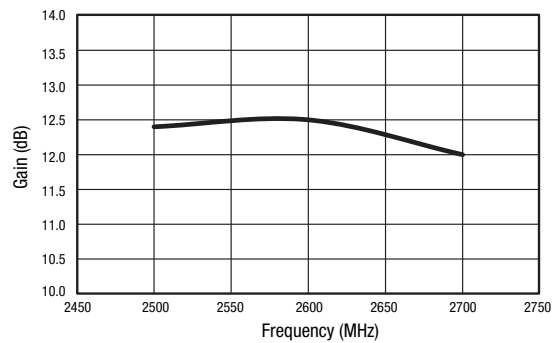

Figure 69. Gain vs Frequency @ 2600 MHz

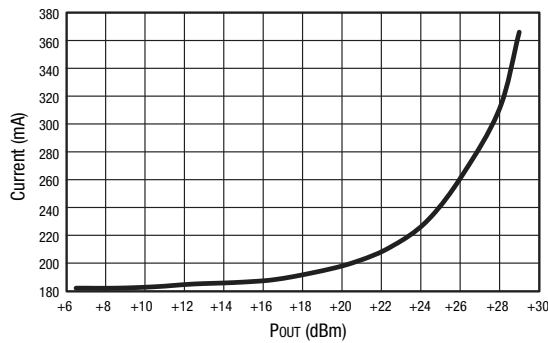

Figure 70. Current vs Pout @ 2600 MHz

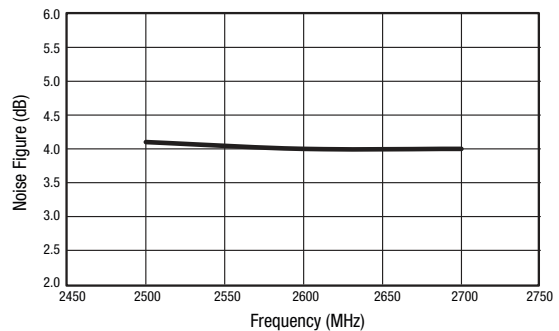

Figure 71. Noise Figure vs Frequency @ 2600 MHz

Table 10. SKY65162-70LF Electrical Characteristics¹
(VCC = +5.5 V, Tc = 25 °C, f = 3600 MHz, Unless Otherwise Noted)

Parameter	Symbol	Test Conditions	Min	Typ	Max	Units
Frequency	f		3400	3600	3800	MHz
Small signal gain	S21	Small signal		9.5		dB
Input return loss	S11	Small signal		12		dB
Output return loss	S22	Small signal		18		dB
Reverse transmission loss	S12	Small signal		23		dB
1 dB output compression point	OP1dB	CW		+28.7		dBm
Saturated output power	PSAT			+31.0		dBm
Saturation current	ISAT	@ PSAT = +31.0 dBm		720		mA
Third order output intercept point	OIP3	POUT = +10 dBm		+42		dBm
Noise figure	NF			5.0		dB
Operating current	IOP	@ P1dB = +28.7 dBm		425		mA
Quiescent current	ICQ	No RF (VCC = 5.5 V)		200		mA

¹ Performance shown in this table is verified by characterization and is not guaranteed by production test.

Typical Performance Characteristics

(VCC = +5.5 V, Tc = 25 °C, f = 3600 MHz, Unless Otherwise Noted)

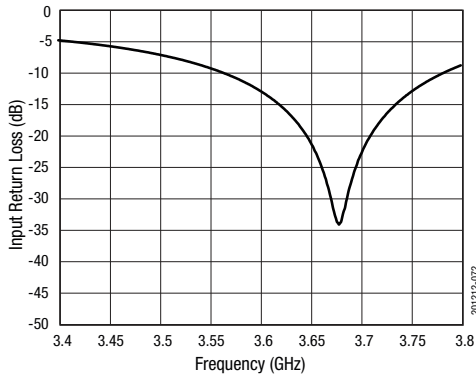

Figure 72. Input Return Loss vs Frequency

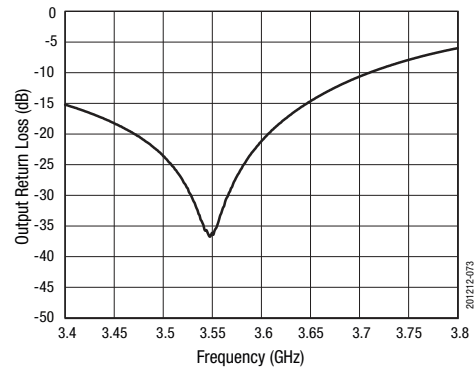

Figure 73. Output Return Loss vs Frequency

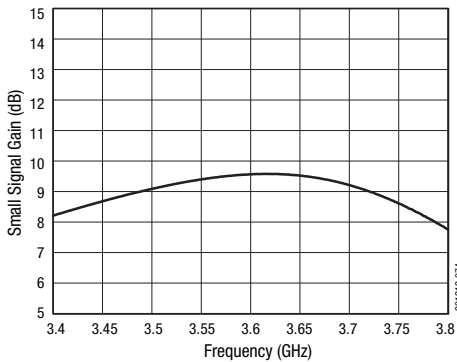

Figure 74. Small Signal Gain vs Frequency

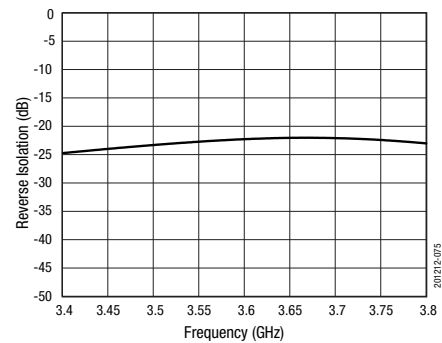

Figure 75. Reverse Isolation vs Frequency

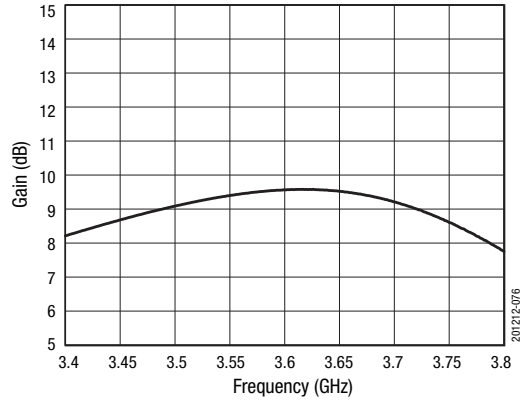

Figure 76. Gain vs Frequency

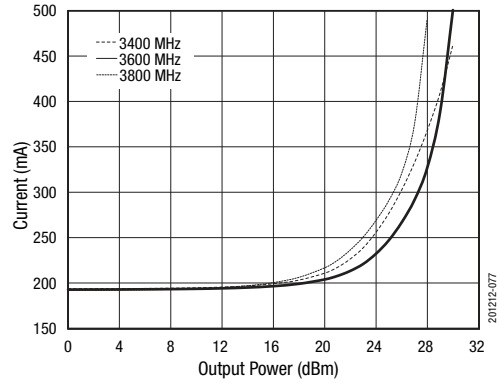

Figure 77. Current vs Output Power

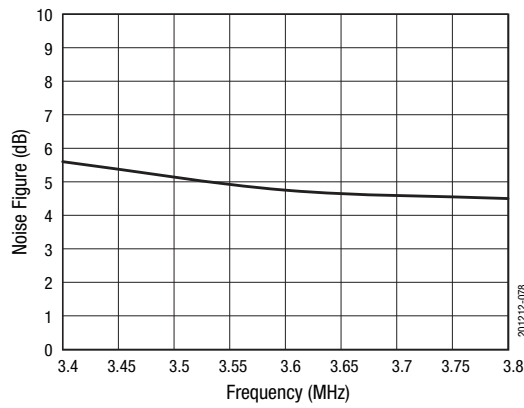

Figure 78. Noise Figure vs Frequency

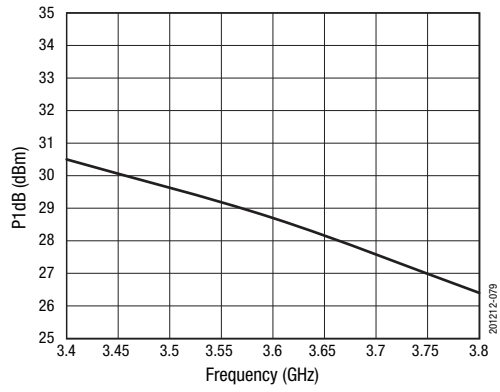

Figure 79. P1dB vs Frequency

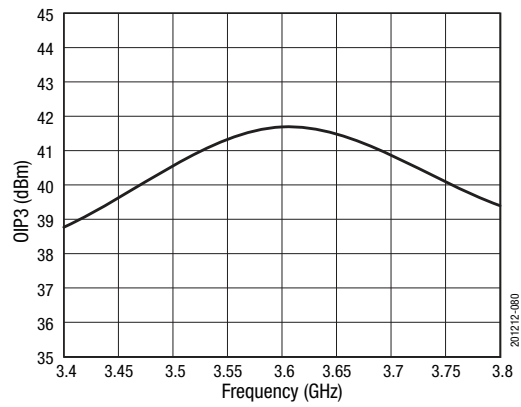

Figure 80. OIP3 vs Frequency
(Pout = +10 dBm/tone)

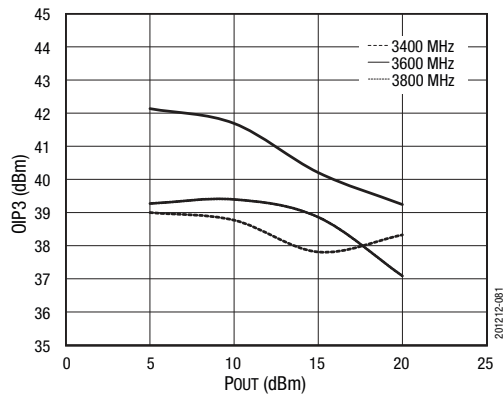

Figure 81. OIP3 vs Pout

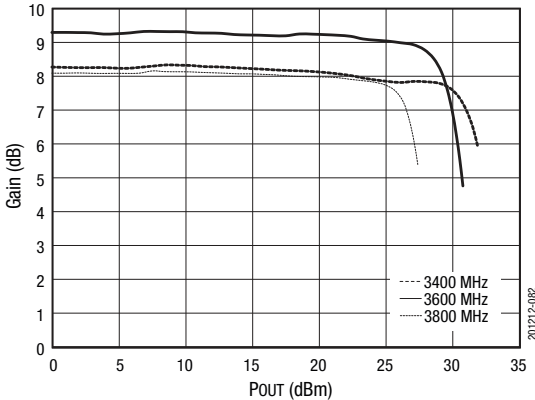

Figure 82. Gain vs Pout

Evaluation Board Description

The Skyworks SKY65162-70LF Evaluation Board is used to test the performance of the SKY65162-70LF PA driver. An assembly drawing for the Evaluation Board is shown in Figure 83 and the layer detail is provided in Figure 84. The layer detail physical characteristics are noted in Figure 85.

Capacitors C7, C8, and C9 provide DC bias decoupling for VCC. Pins 1 and 3 are the RF input and output signals, respectively. External DC blocking is required on the input and output, but can be implemented as part of the RF matching circuit. Pin 2 and the package backside metal, pin 4, are ground pins that provide the DC and RF ground, respectively.

Testing Procedure

Use the following procedure to set up the SKY65162-70LF Evaluation Board for testing:

1. Connect a 5.0 V supply to VCC. If available, enable the current limiting function of the power supply to 400 mA.
2. Connect a signal generator to the RF signal input port. Set it to the desired RF frequency at a power level of -15 dBm or less to the Evaluation Board but do NOT enable the RF signal.
3. Connect a spectrum analyzer to the RF signal output port.
4. Enable the power supply.
5. Enable the RF signal.
6. Take measurements.

CAUTION: *If any of the output signals exceed the rated maximum values, the SKY65162-70LF Evaluation Board can be permanently damaged.*

Circuit Design Configurations

The following design considerations are general in nature and must be followed regardless of final use or configuration.

1. Paths to ground should be made as short as possible.
2. The ground pad of the SKY65162-70LF power amplifier has special electrical and thermal grounding requirements. This pad is the main thermal conduit for heat dissipation. Since the circuit board acts as the heat sink, it must shunt as much heat as possible from the amplifier. As such, design the connection to the ground pad to dissipate the maximum wattage produced to the circuit board. Multiple vias to the grounding layer are required.

NOTE: *Junction temperature (T_j) of the device increases with a poor connection to the slug and ground. This reduces the lifetime of the device.*

A suggested matching circuit is shown in Figure 86. Component values for the SKY65162-70LF Evaluation Board are shown in Table 11. The Evaluation Board is available in seven configurations, numbered EK1 through EK7. Each Evaluation Board is designed for optimum operation at the frequency specified in the BOM table.

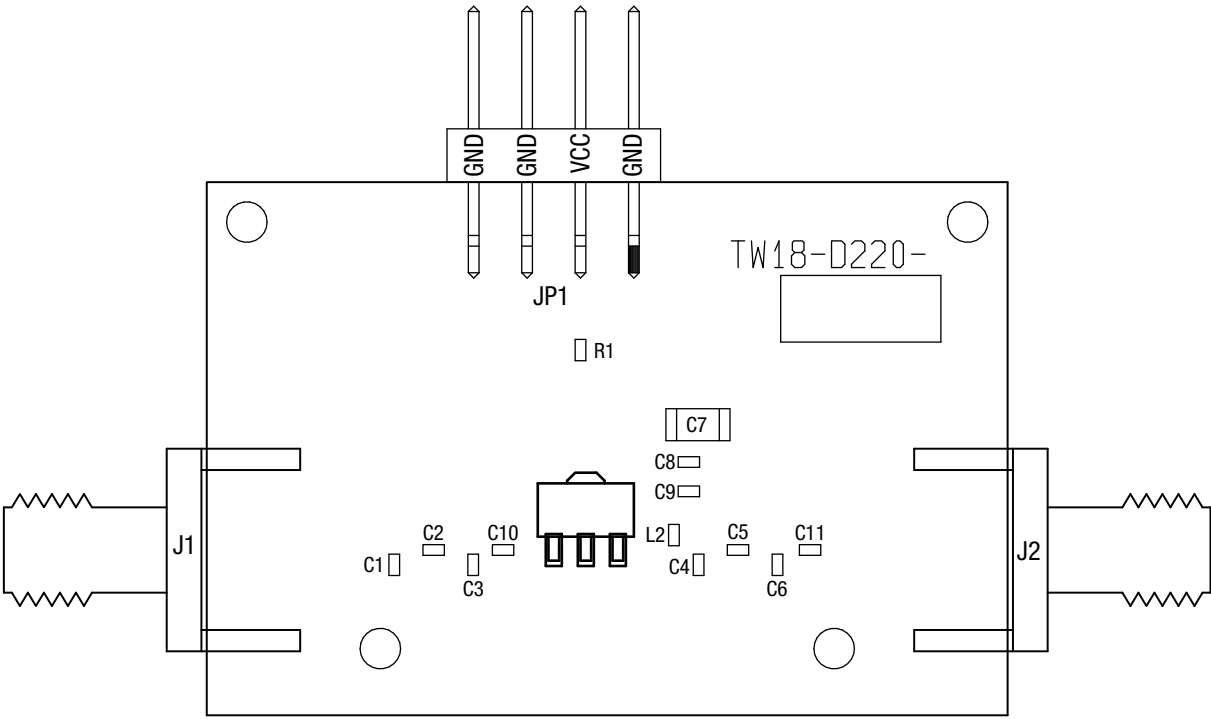

S1886

Figure 83. Evaluation Board Assembly Drawing

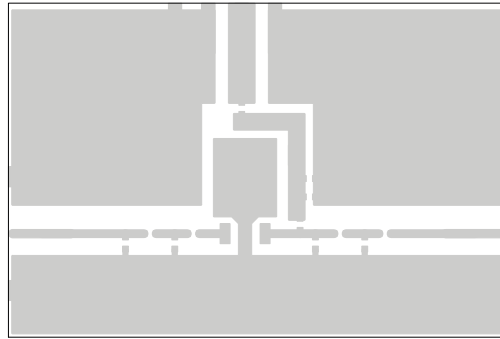

Layer 1: Top – Metal

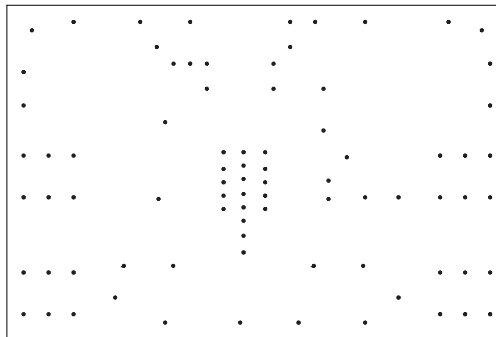

Layer 2: Ground

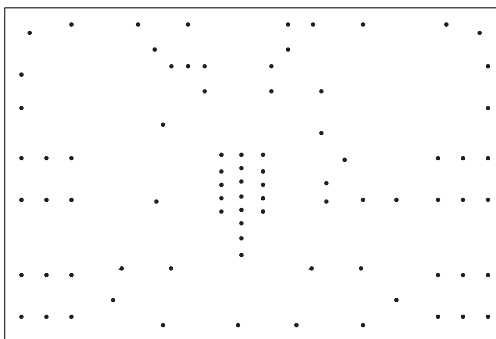

Layer 3: Ground

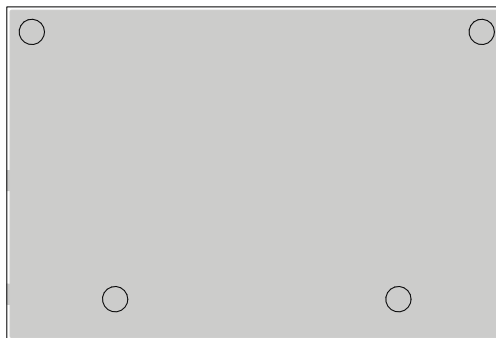

Layer 4: Solid Ground Plane

S2056

Figure 84. Evaluation Board Layer Detail

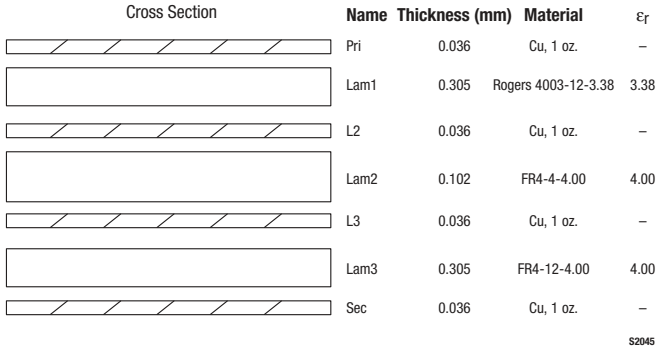
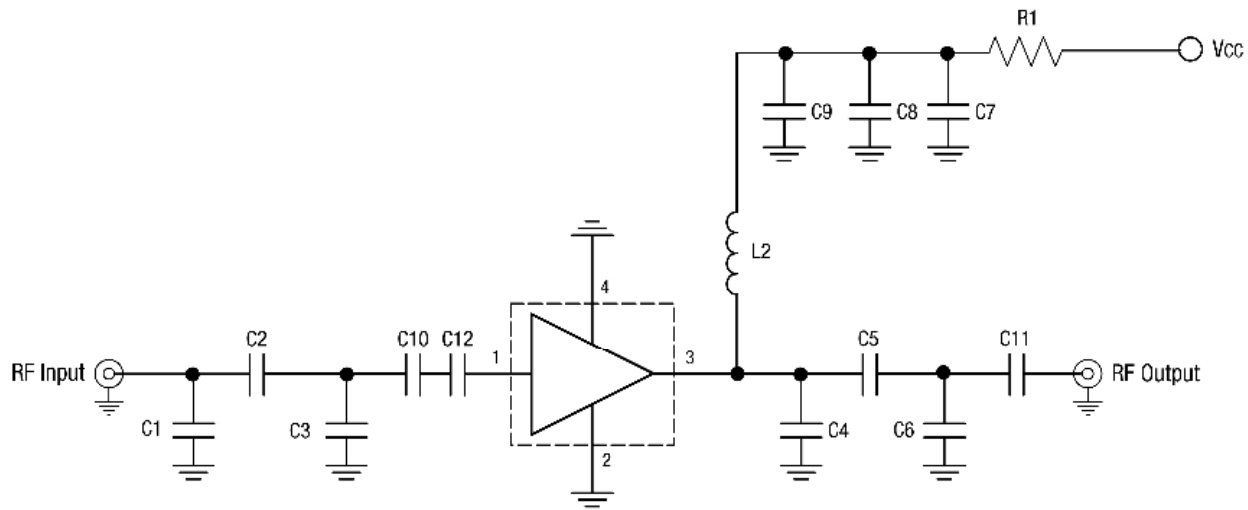

Figure 85. Layer Detail Physical Characteristics



NOTE: Some component labels may be different than the corresponding component symbol shown here. Component values, however, are accurate as of the date of this Data Sheet.

Component C12 is not available on the Evaluation Board. It is only used for 400 MHz matching.

S1682a

Figure 86. SKY65162-70LF Evaluation Board Schematic

Table 11. SKY65162-70LF (SOT-89 Package) Evaluation Board Bill of Materials with EK#/Operating Frequency Breakdown

Component	Size	EK1	EK2	EK3	EK4	EK5	EK6	EK7
		400 MHz	915 MHz	1960 MHz	2100 MHz	2400 MHz	2600 MHz	3600 MHz
C1	0402	8.2 pF	4.3 nH	DNI	DNI	DNI	DNI	1.0 pF
C2	0402	30 pF	4.3 pF	1.3 pF	1.0 pF	0.8 pF	0.8 pF	0 Ω
C3	0402	DNI	DNI	1.3 pF	0.8 pF	0.7 pF	0.3 pF	DNI
C4	0402	DNI	DNI	2.7 pF	1.8 pF	1.5 pF	0.9 pF	DNI
C5	0402	20 pF	3.9 nH	4.7 pF	3.0 pF	1.5 pF	1.0 pF	0.8 pF
C6	0402	8.2 nH	2.4 pF	DNI	DNI	DNI	DNI	0.8 pF
C7	0805	1.0 μF	1.0 μF	1.0 μF	1.0 μF	1.0 μF	1.0 μF	1.0 μF
C8	0402	1000 pF	1000 pF	1000 pF	1000 pF	1000 pF	1000 pF	1000 pF
C9	0402	DNI	DNI	DNI	DNI	DNI	DNI	DNI
C10	0402	10 nH	1.5 Ω	0 Ω	0 Ω	0 Ω	0 Ω	0.6 pF
C11	0402	0 Ω	3.6 pF	0 Ω	0 Ω	0 Ω	0 Ω	0 Ω
C12	0402	10 Ω	DNI	DNI	DNI	DNI	DNI	DNI
L2	0402	36 nH	8.7 nH	8.7 nH	8.7 nH	8.7 nH	8.7 nH	8.7 nH
R1	0402	0 Ω	0 Ω	0 Ω	0 Ω	0 Ω	0 Ω	0 Ω

Package Dimensions

Package dimensions are shown in Figure 87, and tape and reel dimensions are provided in Figure 88.

Package and Handling Information

Since the device package is sensitive to moisture absorption, it is baked and vacuum packed before shipping. Instructions on the shipping container label regarding exposure to moisture after the container seal is broken must be followed. Otherwise, problems related to moisture absorption may occur when the part is subjected to high temperature during solder assembly.

The SKY65162-70LF is rated to Moisture Sensitivity Level 1 (MSL1) at 260 °C. It can be used for lead or lead-free soldering. For additional information, refer to the Skyworks Application Note, *Solder Reflow Information*, document number 200164.

Care must be taken when attaching this product, whether it is done manually or in a production solder reflow environment. Production quantities of this product are shipped in a standard tape and reel format.

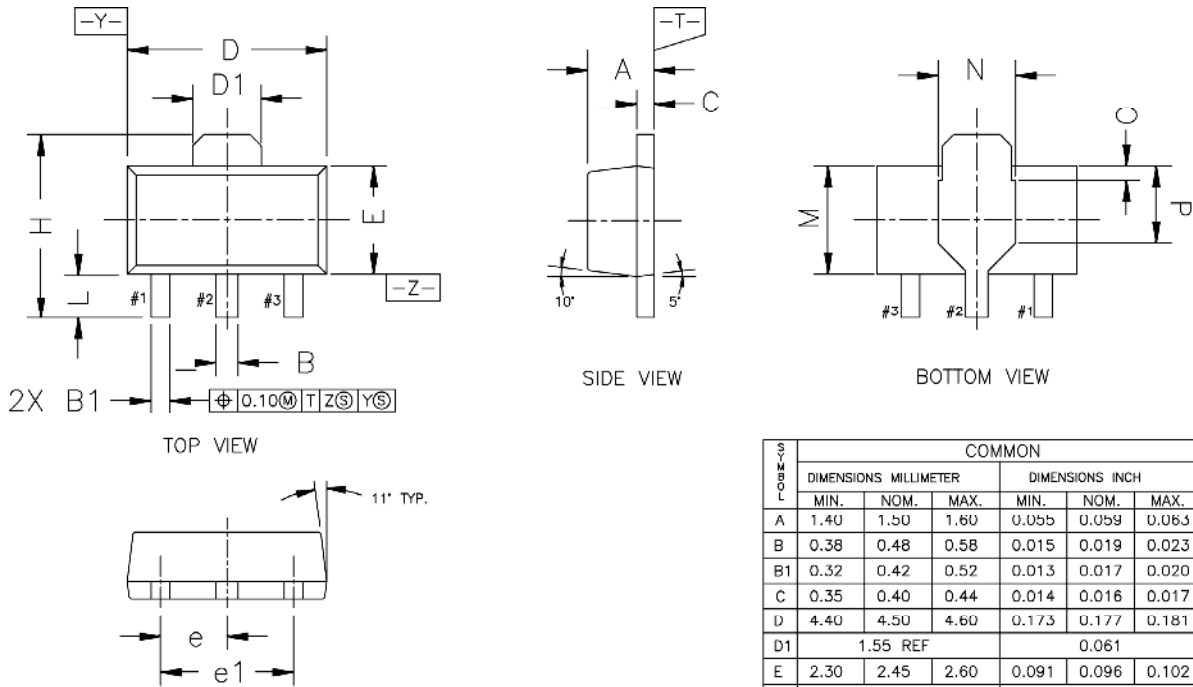

NOTES:

1. DIMENSIONING AND TOLERANCING CONFORM TO ANSI Y14.5M-1982.
2. PACKAGE DIMENSION DOES NOT INCLUDE MOLD PROTRUSIONS OR GATE BURRS. MOLD PROTRUSIONS AND GATE BURRS SHALL NOT EXCEED 0.005" PER END. BODY WIDTH DIMENSION DOES NOT INCLUDE INTERLEAD MOLD PROTRUSIONS. INTERLEAD PROTRUSIONS SHALL NOT EXCEED 0.005" PER SIDE.
3. LEADWIDTH DIMENSION DOES NOT INCLUDE DAMBAR PROTRUSIONS. ALLOWABLE PROTRUSION SHALL NOT EXCEED 0.002" TOTAL IN EXCESS OF LEAD WIDTH DIMENSION AT MAXIMUM MATERIAL CONDITION.
4. PLATING REQUIREMENT PER SOURCE CONTROL DRAWING (SCD) 2504.

SYMBOL	COMMON					
	DIMENSIONS MILLIMETER			DIMENSIONS INCH		
	MIN.	NOM.	MAX.	MIN.	NOM.	MAX.
A	1.40	1.50	1.60	0.055	0.059	0.063
B	0.38	0.48	0.58	0.015	0.019	0.023
B1	0.32	0.42	0.52	0.013	0.017	0.020
C	0.35	0.40	0.44	0.014	0.016	0.017
D	4.40	4.50	4.60	0.173	0.177	0.181
D1	1.55 REF			0.061		
E	2.30	2.45	2.60	0.091	0.096	0.102
e	1.50 BSC			0.059 BSC		
e1	3.00 BSC			0.118 BSC		
H	3.94	4.15	4.25	0.155	0.163	0.167
L	0.90	1.00	1.20	0.035	0.039	0.047
M	2.38 REF			0.094		
N	1.75 REF			0.069		
O	0.32 REF			0.013		
P	1.75 REF			0.069		

Figure 87. SKY65162-70LF Package Dimensions

DATA SHEET • SKY65162-70LF: LINEAR PA

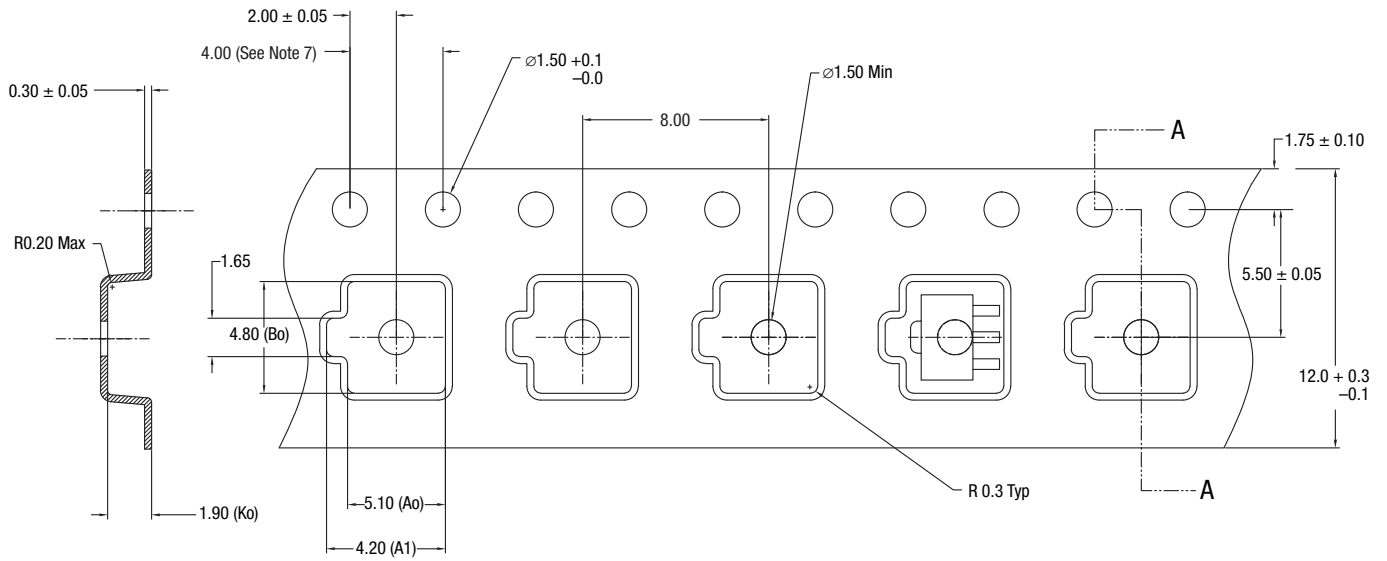

Notes:

1. Carrier tapes must meet all requirements of Skyworks GP01-D233 procurement spec for tape and reel shipping.
2. Carrier tape material: black conductive polycarbonate or polystyrene.
3. Cover tape material: transparent conductive PSA.
Cover tape size: 9.2 mm width.
4. Typical ESD surface resistivity must meet all ESD requirements of Skyworks specified in GP01-D233.
5. Ao and Bo measurement point to be 0.30 mm from bottom pocket.
6. All measurements are in millimeters.
7. 10-sprocket hole pitch cumulative tolerance 0.2 mm.

200953-100

Figure 88. SKY65162-70LF Tape and Reel Dimensions

Ordering Information

Part Number	Product Description	Evaluation Board Part Number
SKY65162-70LF	SKY65162-70LF: 400 to 3800 MHz Linear Power Amplifier	SKY65162-70EK1 (400 MHz) SKY65162-70EK2 (915 MHz) SKY65162-70EK3 (1960 MHz) SKY65162-70EK4 (2100 MHz) SKY65162-70EK5 (2400 MHz) SKY65162-70EK6 (2600 MHz) SKY65162-70EK7 (3600 MHz)

Copyright © 2010, 2011, 2013, 2016-2018 Skyworks Solutions, Inc. All Rights Reserved.

Information in this document is provided in connection with Skyworks Solutions, Inc. ("Skyworks") products or services. These materials, including the information contained herein, are provided by Skyworks as a service to its customers and may be used for informational purposes only by the customer. Skyworks assumes no responsibility for errors or omissions in these materials or the information contained herein. Skyworks may change its documentation, products, services, specifications or product descriptions at any time, without notice. Skyworks makes no commitment to update the materials or information and shall have no responsibility whatsoever for conflicts, incompatibilities, or other difficulties arising from any future changes.

No license, whether express, implied, by estoppel or otherwise, is granted to any intellectual property rights by this document. Skyworks assumes no liability for any materials, products or information provided hereunder, including the sale, distribution, reproduction or use of Skyworks products, information or materials, except as may be provided in Skyworks Terms and Conditions of Sale.

THE MATERIALS, PRODUCTS AND INFORMATION ARE PROVIDED "AS IS" WITHOUT WARRANTY OF ANY KIND, WHETHER EXPRESS, IMPLIED, STATUTORY, OR OTHERWISE, INCLUDING FITNESS FOR A PARTICULAR PURPOSE OR USE, MERCHANTABILITY, PERFORMANCE, QUALITY OR NON-INFRINGEMENT OF ANY INTELLECTUAL PROPERTY RIGHT; ALL SUCH WARRANTIES ARE HEREBY EXPRESSLY DISCLAIMED. SKYWORKS DOES NOT WARRANT THE ACCURACY OR COMPLETENESS OF THE INFORMATION, TEXT, GRAPHICS OR OTHER ITEMS CONTAINED WITHIN THESE MATERIALS. SKYWORKS SHALL NOT BE LIABLE FOR ANY DAMAGES, INCLUDING BUT NOT LIMITED TO ANY SPECIAL, INDIRECT, INCIDENTAL, STATUTORY, OR CONSEQUENTIAL DAMAGES, INCLUDING WITHOUT LIMITATION, LOST REVENUES OR LOST PROFITS THAT MAY RESULT FROM THE USE OF THE MATERIALS OR INFORMATION, WHETHER OR NOT THE RECIPIENT OF MATERIALS HAS BEEN ADVISED OF THE POSSIBILITY OF SUCH DAMAGE.

Skyworks products are not intended for use in medical, lifesaving or life-sustaining applications, or other equipment in which the failure of the Skyworks products could lead to personal injury, death, physical or environmental damage. Skyworks customers using or selling Skyworks products for use in such applications do so at their own risk and agree to fully indemnify Skyworks for any damages resulting from such improper use or sale.

Customers are responsible for their products and applications using Skyworks products, which may deviate from published specifications as a result of design defects, errors, or operation of products outside of published parameters or design specifications. Customers should include design and operating safeguards to minimize these and other risks. Skyworks assumes no liability for applications assistance, customer product design, or damage to any equipment resulting from the use of Skyworks products outside of stated published specifications or parameters.

Skyworks and the Skyworks symbol are trademarks or registered trademarks of Skyworks Solutions, Inc. or its subsidiaries in the United States and other countries. Third-party brands and names are for identification purposes only, and are the property of their respective owners. Additional information, including relevant terms and conditions, posted at www.skyworksinc.com, are incorporated by reference.