

**User Manual**  
Rev. 1.1  
**CC2400DK Development Kit**

## Table of contents

<b>INTRODUCTION</b> .....	<b>3</b>
<b>EVALUATION MODULE</b> .....	<b>4</b>
CIRCUIT DESCRIPTION .....	4
PCB LAYOUT .....	4
SCHEMATIC .....	10
<b>EVALUATION BOARD</b> .....	<b>12</b>
POWER SUPPLY SECTION .....	12
USB INTERFACE .....	14
RS-232 INTERFACE .....	14
JUMPERS .....	14
MICROCONTROLLER AND FPGA .....	15
CONNECTORS .....	16
PCB LAYOUT .....	17
SCHEMATICS, CC2400EB .....	20
BILL OF MATERIALS, CC2400EB .....	25
<b>USING THE DEVELOPMENT KIT</b> .....	<b>31</b>
CC2400 RF EVALUATION USING SMARTRF <sup>®</sup> STUDIO .....	31
USING THE CC2400DK FOR PROTOTYPING .....	32
<b>TROUBLESHOOTING</b> .....	<b>33</b>
IT DOES NOT WORK .....	33
SMARTRF <sup>®</sup> STUDIO DOES NOT RECOGNIZE THE CC2400EB .....	33

## Introduction

The CC2400 single-chip RF transceiver provides a highly integrated, flexible low-cost solution for applications using the worldwide unlicensed 2.4 GHz frequency band. The CC2400DK development kit is a powerful and flexible tool specifically designed to make it easy for the user to evaluate the RF performance of the CC2400 and to minimize the time spent on evaluation.

The Development Kit includes two Evaluation Boards and two Evaluation Modules. The Evaluation Modules contain the CC2400 chip and required external components.

The Evaluation Board serves as a motherboard for the Evaluation Modules. The Evaluation Board provides a USB port, a serial port, buttons, LEDs, voltage regulator, configuration jumpers and connectors to make it easy to interface the CC2400 with the SmartRF<sup>®</sup> Studio software and various test equipment.

This User Manual describes how to use the Development Kit. SmartRF<sup>®</sup> Studio is documented in its own user manual.

Your SmartRF<sup>®</sup> CC2400DK Development Kit should contain the following items:

Kit contents	
<i>Item</i>	<i>Number of articles</i>
Evaluation Board (CC2400EB)	2
Evaluation Module (CC2400EM)	2
Quick Start instructions	1
Antenna, 50Ω quarter-wave monopole, SMA male connector	2
SMA to BNC adapters	4
USB cable	2
CC2400 sample kit	1

## Evaluation Module

The Evaluation Module contains the CC2400 chip together with the needed external circuitry for operation. Not all components are needed in an actual application. Please see the datasheet for a typical application circuit.

The CC2400 operates in the 2.4 GHz frequency band. Although this frequency band is usually described as “world-wide”, some countries do not allow unlicensed operation in this band. Please refer to application note AN001 for more information about applicable regulations.

**Important:** *Contact your local telecommunication authorities before transmitting an RF signal.*

### Circuit description

The CC2400 RF section includes all the necessary components for correct operation.

The CC2400 is connected to a 16 MHz crystal.

The Evaluation Module can be plugged into the Evaluation Board. Two 2x10 pin pin row connectors with 0.050-inch pitch are used for this purpose.



**Figure 1: CC2400EM Evaluation Module**

### PCB layout

RF circuits operating at high frequencies are sensitive to the physical layout of the PCB. Chipcon has carefully optimized the layout of the CC2400EM evaluation module and we therefore recommend that the user copies it when making own PCB designs.

The PCB is of a 4-layer type in order to provide a well-defined ground plane as well as adequate routing space. The laminate used is standard FR-4 board material. The PCB is 1.0mm thick, with layer 1 on the top side, layers 2 and 3 are internal layers and layer 4 is on the bottom side. Layers 1 and 4 are used for routing, while layer 2 is a ground plane and layer 3 is used for power routing. All areas not utilized for routing are filled with copper connected to ground to provide RF shielding. The ground planes on all layers are stitched together with closely spaced vias.

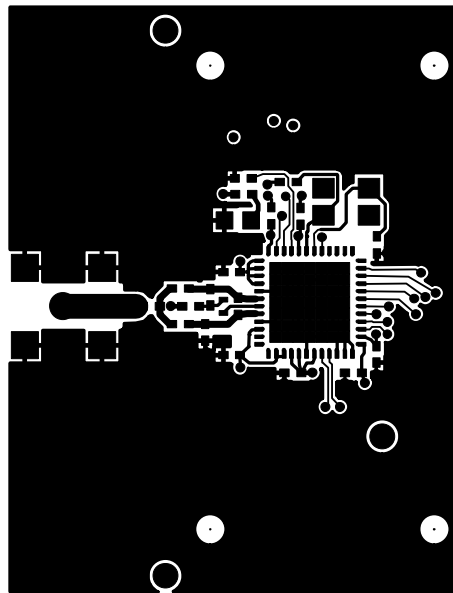

Figure 2: CC2400EM PCB layout, layer 1

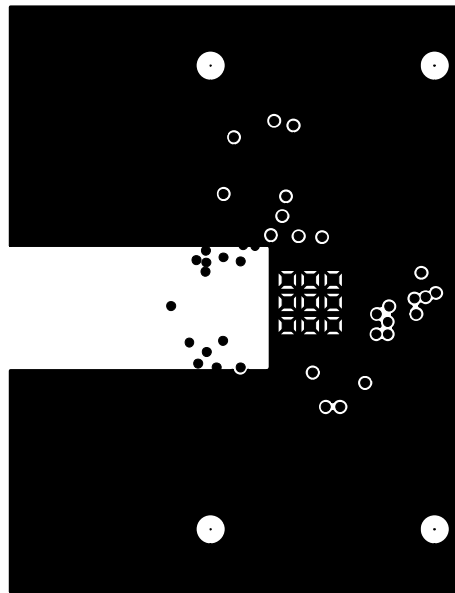

Figure 3: CC2400EM PCB layout, layer 2

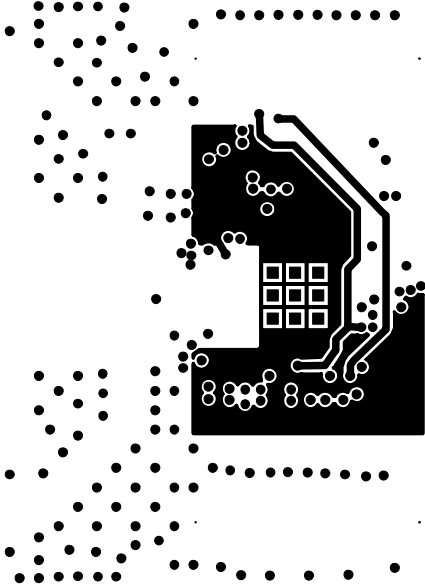

Figure 4: CC2400 PCB layout, layer 3

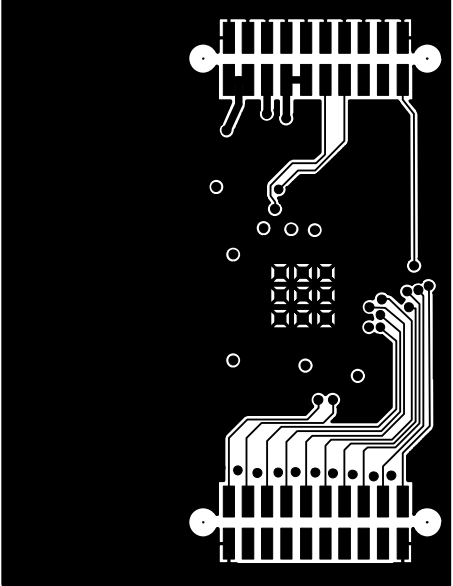
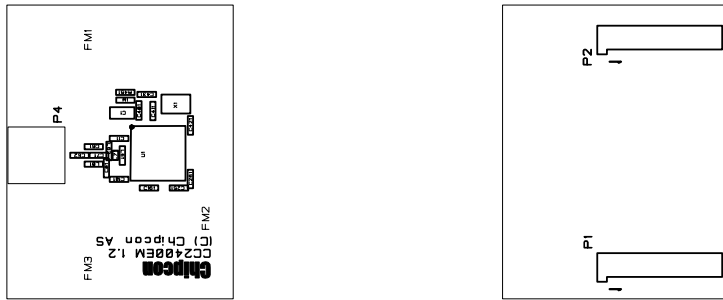

Figure 5: CC2400EM PCB layout, layer 4





**Figure 6: CC2400EM component placement, top side (left) and bottom side (right)**

**Schematic**

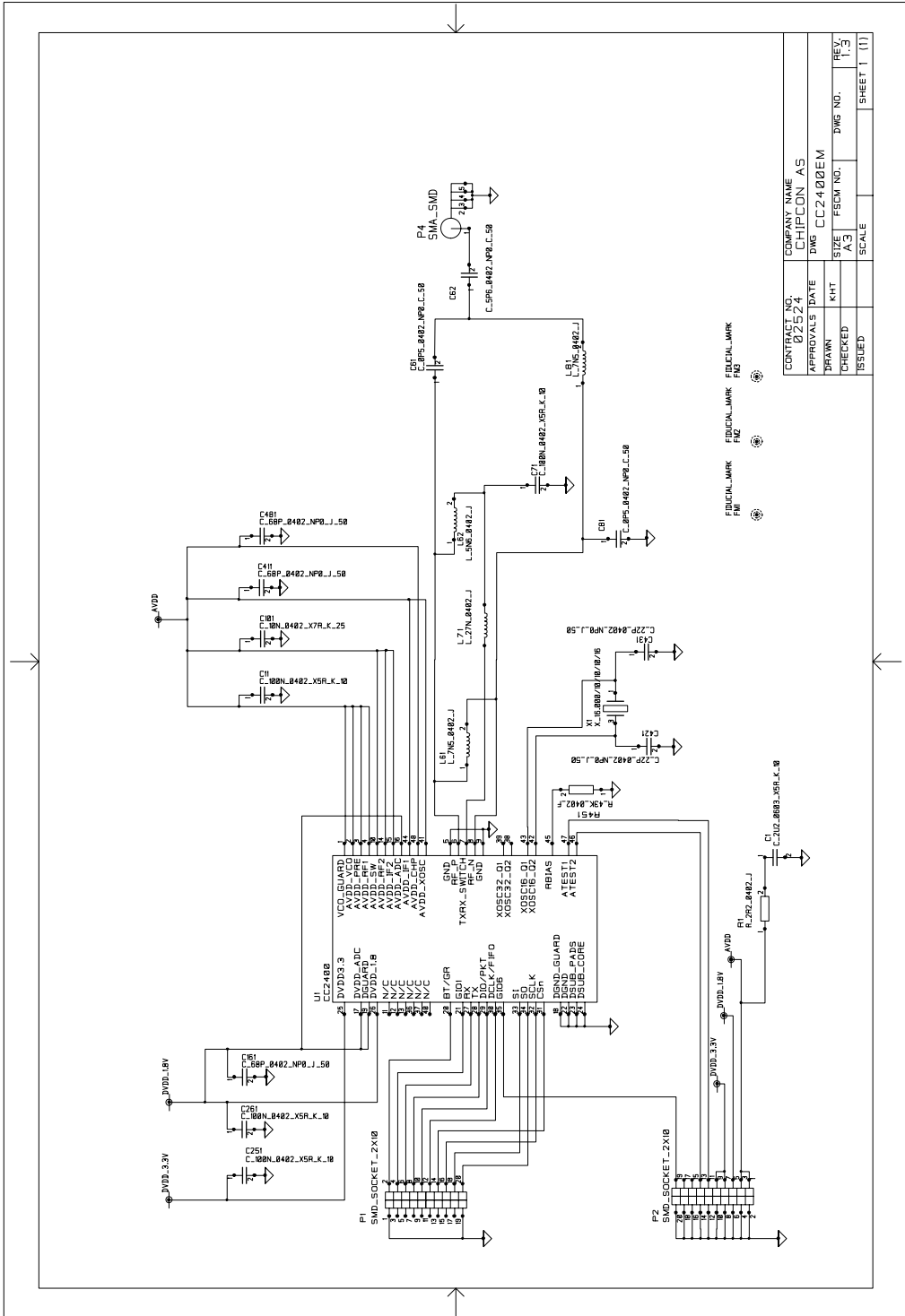

**Bill of materials, CC2400EM**

<b>Bill of materials, CC2400EM</b>			
<i>Reference</i>	<i>Description</i>	<i>Value</i>	<i>Part</i>
C1	Capacitor 0603	2.2 $\mu$ F, 10%	C_2U2_0603_X5R_K_10
C11	Capacitor 0402	100 nF, 10%	C_100N_0402_X5R_J_10
C61	Capacitor 0402	0.5 pF, $\pm$ 0.25 pF	C_0P5_0402_NP0_C_50
C62	Capacitor 0402	5.6 pF, $\pm$ 0.25 pF	C_5P6_0402_NP0_C_50
C71	Capacitor 0402	100 nF, 10%	C_100N_0402_X5R_J_10
C81	Capacitor 0402	0.5 pF, $\pm$ 0.25 pF	C_0P5_0402_NP0_C_50
C101	Capacitor 0402	10 nF, 10%	C_10N_0402_X7R_K_25
C161	Capacitor 0402	68 pF, 5%	C_68P_0402_NP0_J_50
C251	Capacitor 0402	100 nF, 10%	C_100N_0402_X5R_K_10
C261	Capacitor 0402	100 nF, 10%	C_100N_0402_X5R_K_10
C411	Capacitor 0402	68 pF, 5%	C_68P_0402_NP0_J_50
C421	Capacitor 0402	27 pF, 5%	C_27P_0402_NP0_J_50
C431	Capacitor 0402	27 pF, 5%	C_27P_0402_NP0_J_50
C481	Capacitor 0402	68 pF, 5%	C_68P_0402_NP0_J_50
L61	Inductor 0402	7.5 nH, 5%	L_7N5_0402_J
L62	Inductor 0402	5.6 nH, 5%	L_5N6_0402_J
L71	Inductor 0402	27 nH, 5%	L_27N_0402_J
L81	Inductor 0402	7.5 nH, 5%	L_7N5_0402_J
P1	SMD pinrow socket		SMD_SOCKET_2x10 (Samtec SFM-110-02-S-D-A-K-TR)
P2	SMD pinrow socket		SMD_SOCKET_2x10 (Samtec SFM-110-02-S-D-A-K-TR)
P4	Surface-mount SMA, straight		SMA_SMD
R1	Resistor 0402	2.2 $\Omega$ , 5%	R2R2_0402_J
R451	Resistor 0402	43 k $\Omega$ , 1%	R_43K_0402_F
U1	Single-chip transceiver		CC2400
X1	Crystal, ceramic SMD 4x25mm		X_16.000/10/10/10/16 (Toyocom TSX-10A 16M 16pF)

*Note:* The crystal X1 mounted on the EM board is a 16.000 MHz crystal, with  $\pm$ 10 ppm initial tolerance,  $\pm$  10 ppm drift over temperature and a temperature range of -10° C to +60° C. The crystal is designed for 16 pF load capacitance. In an actual application, the tolerance, drift and temperature range of the crystal must be considered with application requirements in mind. Please consult the data sheet and SmartRF® Studio for more information. It is possible to choose a larger crystal package to save cost. The crystal should have an ESR of 60  $\Omega$  or less.

## Evaluation Board

The Evaluation Board is used as a motherboard for the Evaluation Modules and provides power and external connections.

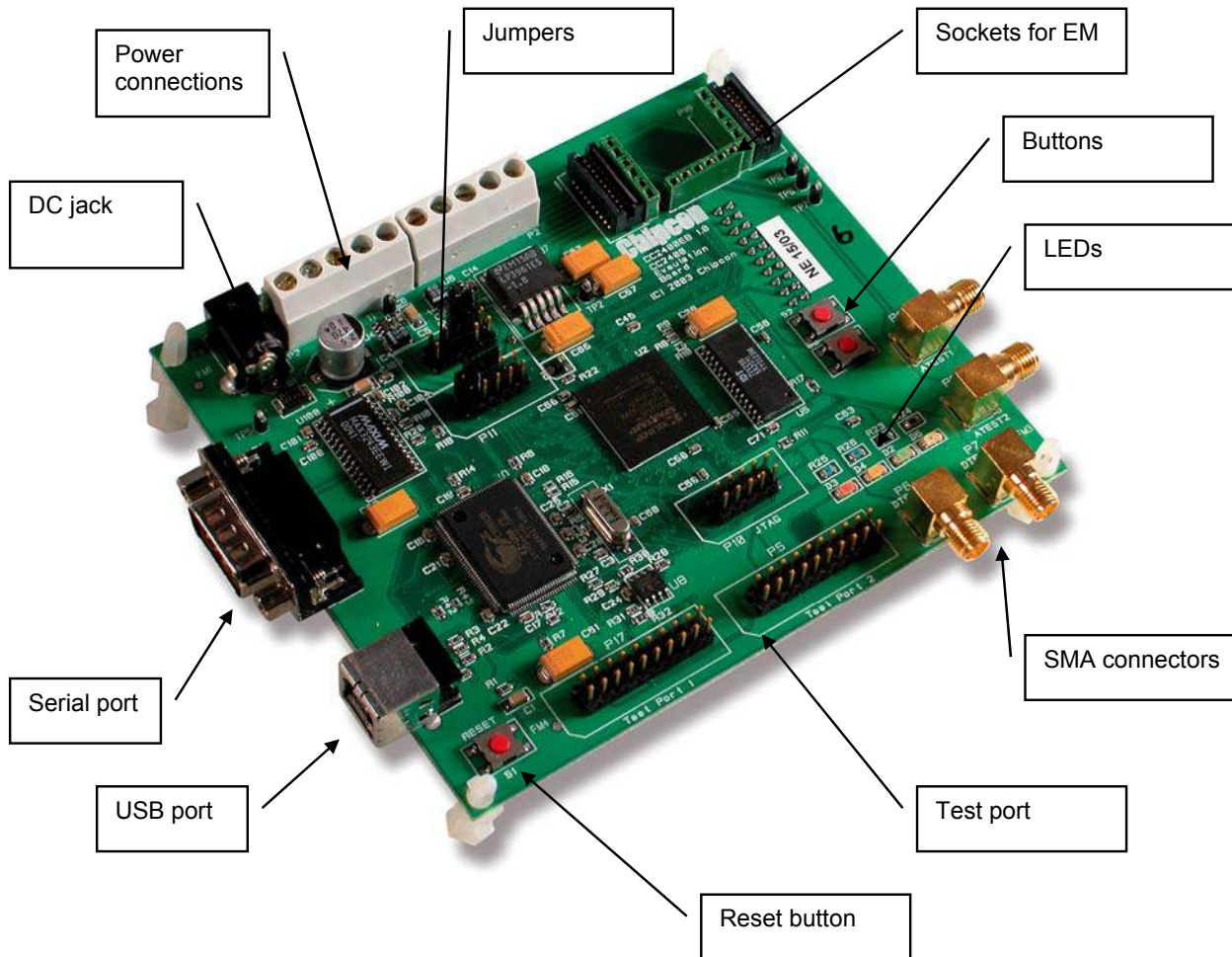

**Figure 7: CC2400EB Evaluation Board**

### Power supply section

The power supply section is configured by moving the jumpers located on the board. There are three voltage regulators on the board, one for use by the FPGA, a 3.3 V regulator for general use and a 1.8 V regulator for powering the CC2400. The voltage regulator for the FPGA is turned on under software control when the USB controller has been properly configured.

A diode prevents permanent damage if wrong polarity is applied to the non-regulated input. There are two power connectors; a 3.5mm DC jack-type connector allows you to connect an unregulated battery eliminator easily (the positive supply is on the center pin), and two 5-pin terminal blocks can be used to connect either an unregulated or regulated power supply.

An amperemeter can also be connected in order to measure the DC current drawn by the CC2400. Since the CC2400 has two voltage supplies (Core and I/O), there are separate

current measurement loops for these two supplies. If you are not going to measure the currents, short-circuit jumpers must be connected between the terminals, otherwise the Evaluation Module will not be supplied with power.

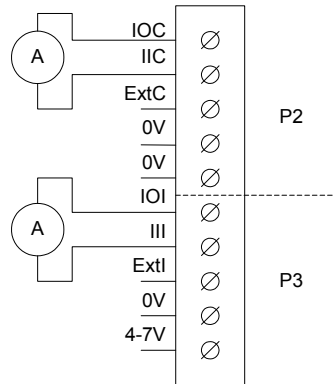

**Figure 8: Power terminal block with amperemeters attached**

**Table 1: Power connector connections**

Connector and pin	Marking	Description
P3 pin 1	4-7V	Unregulated voltage in. Input to voltage regulators. Equivalent with the DC jack input.
P3 pin 2	0V	Circuit ground.
P3 pin 3	ExtI	External I/O voltage. An externally applied voltage will drive the I/O supply of the CC2400 (and the associated FPGA pins) if the jumpers are set correctly.
P3 pin 4	III	I/O supply current input. Insert an amperemeter between this pin and the IOI pin to measure the current drawn by the I/O supply of the CC2400.
P3 pin 5	IOI	I/O supply current output. Insert an amperemeter between this pin and the III pin to measure the current drawn by the I/O supply of the CC2400.
P2 pin 1	0V	Circuit ground.
P2 pin 2	0V	Circuit ground.
P2 pin 3	Ext C	External core voltage. An externally applied voltage that will drive the core supply of the CC2400 if the jumpers are set correctly.
P2 pin 4	IIC	Core voltage current input. Insert an amperemeter between this pin and the IOC pin to measure the current drawn by the core supply of the CC2400.
P2 pin 5	IOC	Core voltage current output. Insert an amperemeter between this pin and the IIC pin to measure the current drawn by the core supply of the CC2400.

**USB interface**

The CC2400EB connects to a PC via a USB interface. SmartRF® Studio uses the USB interface to control the CC2400EB. The USB interface can be used both to configure the CC2400 and transfer data. Chipcon provides a Windows driver that is installed as part of the SmartRF® Studio installation process. This driver must be present for SmartRF® Studio to communicate with the CC2400EB.

Because USB is used, the CC2400DK will only function with PCs running Windows 98, Windows ME, Windows 2000, Windows XP or newer. Windows NT and Windows 95 cannot be used since they do not support USB.

**RS-232 interface**

A serial port is included on the CC2400EB. This is intended for debugging purposes, and *cannot* be used to connect the Evaluation Board to SmartRF® Studio.

**Jumpers**

The jumpers are used to configure the Evaluation Board. The factory default settings are shown below, please return to these settings if you are experiencing any problems.

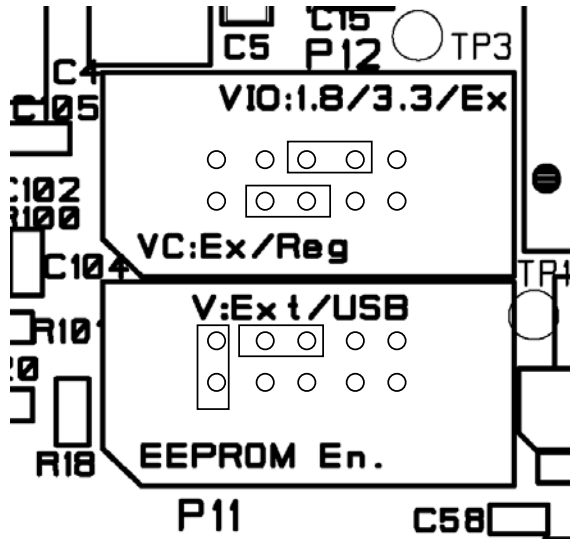

Figure 9 Default jumper settings

<b>Jumpers</b>		
<i>Name</i>	<i>Default setting</i>	<i>Description</i>
VIO	Between pins 6 and 8	Determines how the I/O supply of the CC2400 is supplied with power. If the jumper is connected between pins 8 and 6, the 1.8V supply is used. If the jumper is connected between pins 8 and 10, the 3.3V supply is used. If the jumper is connected between pins 8 and 7, the I/O supply is driven by the external voltage present on the ExtI pin on the power connector.
VC	Between pins 3 and 5	Determines how the core supply of the CC2400 is supplied with power. If the jumper is connected between pins 3 and 5, power is supplied by the 1.8V regulator. If the jumper is connected between pins 3 and 1, the core supply is driven by the external voltage present on the ExtC pin on the power connector.
V	Between pins 4 and 6	Determines how power is supplied to the board. If the jumper is connected between pins 4 and 6, the EB is powered from the power connected to the power connector or the power jack. If the jumper is connected between pins 6 and 8, the EB is powered from the USB bus. In this case, the USB port the EB is connected to must be able to supply 500 mA current.
EEPROM En.	Present	Determines if USB configuration information is loaded from EEPROM memory. If removed, the CC2400EB will report itself as a default USB device. This jumper should always be present during normal operation.

### Microcontroller and FPGA

The CC2400EB has been built around a Cypress USB microcontroller and a Xilinx Spartan II 200E FPGA. This has been done to ensure maximum flexibility and is not representative for a low-cost CC2400 application.

Both the microcontroller and the FPGA are RAM-based devices, and their configuration is loaded via the USB interface on power-up. The CC2400EB must therefore be connected to a PC to function properly.

Four LEDs and two buttons are included on the board for user interface purposes. The LEDs are driven by the FPGA, while the buttons are connected to both the FPGA and the microcontroller.

A reset button is provided, which will reset both the microcontroller and the USB interface.

The LEDs are used to indicate status when the CC2400EB is used together with SmartRF® Studio.

## Connectors

The Evaluation Board is furnished with many connectors for easy access to various signals.

Test Port 1 (P17) and Test Port 2 (P5) are 2x10 pin pin-row connectors that are connected to the FPGA and can be used to monitor various signals, including all the CC2400 signals. The pin-out of these connectors is compatible with logic analyzer probes from Agilent.

The DTEST1 (P6) and DTEST2 (P7) SMA connectors are also connected to the FPGA and can be used to output or input signals from/to the CC2400, respectively.

The ATEST1 (P9) and ATEST2 (P8) provide access to analog test signals from the CC2400.

The selection of what signals are available at the different connectors is done in SmartRF® Studio.



### PCB layout

The Evaluation Board is a 4-layer, 1.6 mm thick FR-4 PCB. Four layers are used because of the routing requirements. Layers 1 and 4 are used for signal routing, layer 2 is a ground plane and layer 3 is used for power routing. The majority of the components are mounted on the top side of the PCB, while a few decoupling capacitors were put on the bottom side.

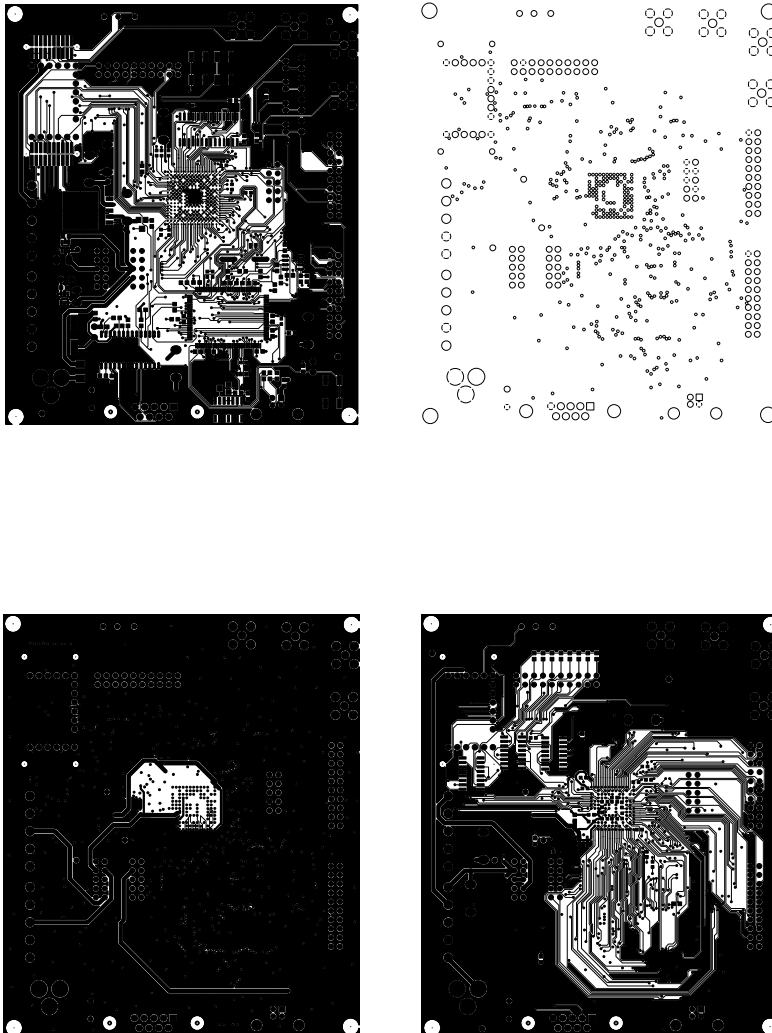

**Figure 10: CC2400EB PCB layout, layer 1 (top left), layer 2 (top right), layer 3 (bottom left) and layer 4 (bottom right)**

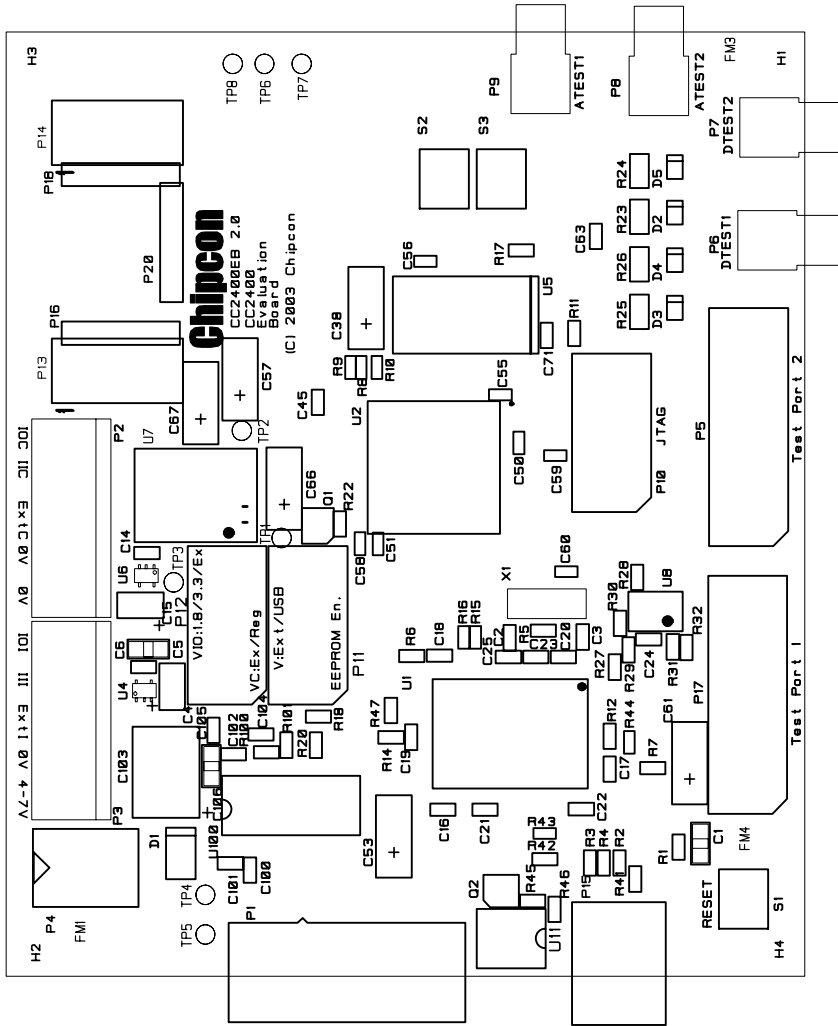

Figure 11: CC2400EB component placement, top side

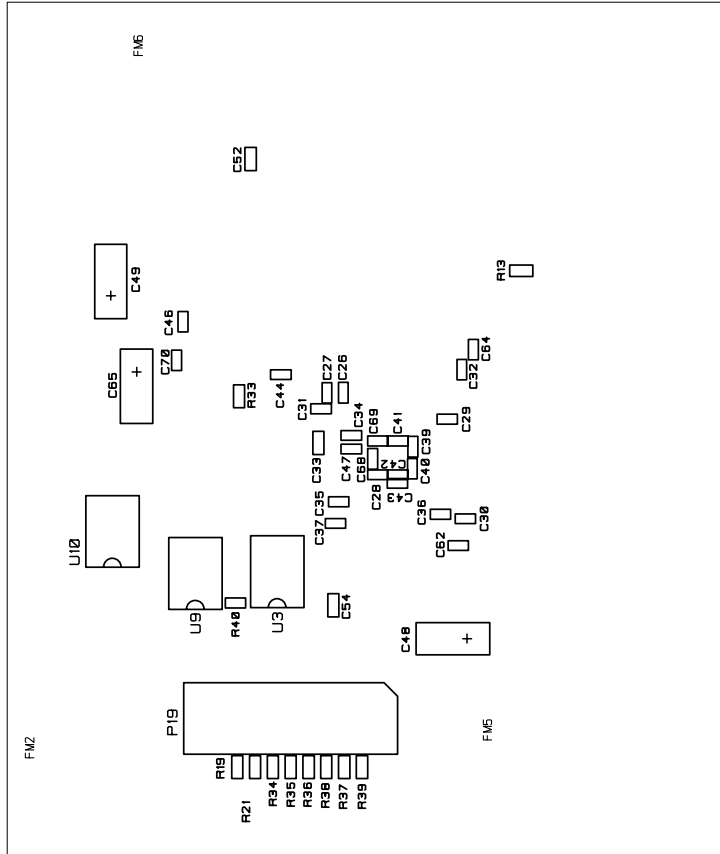
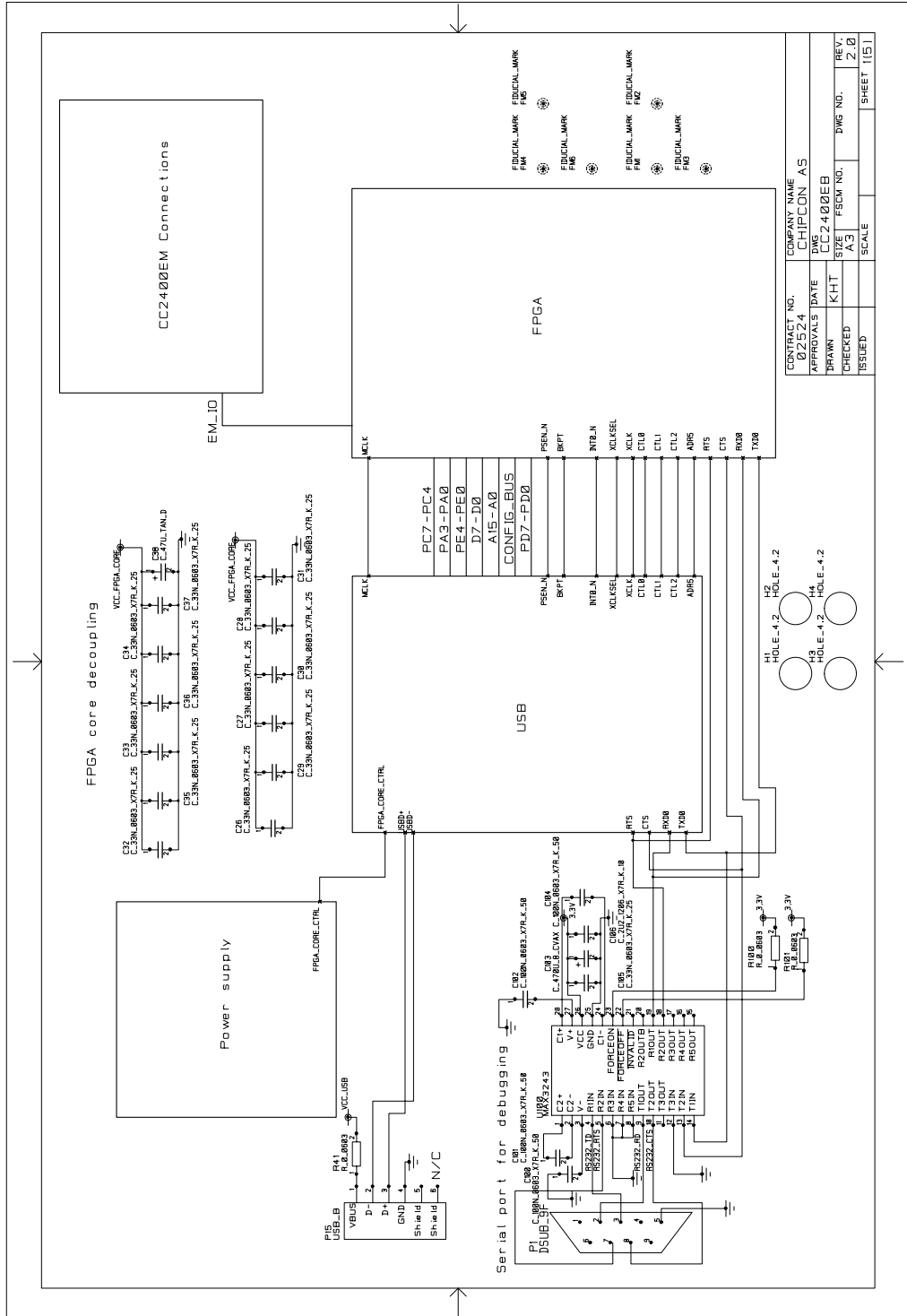
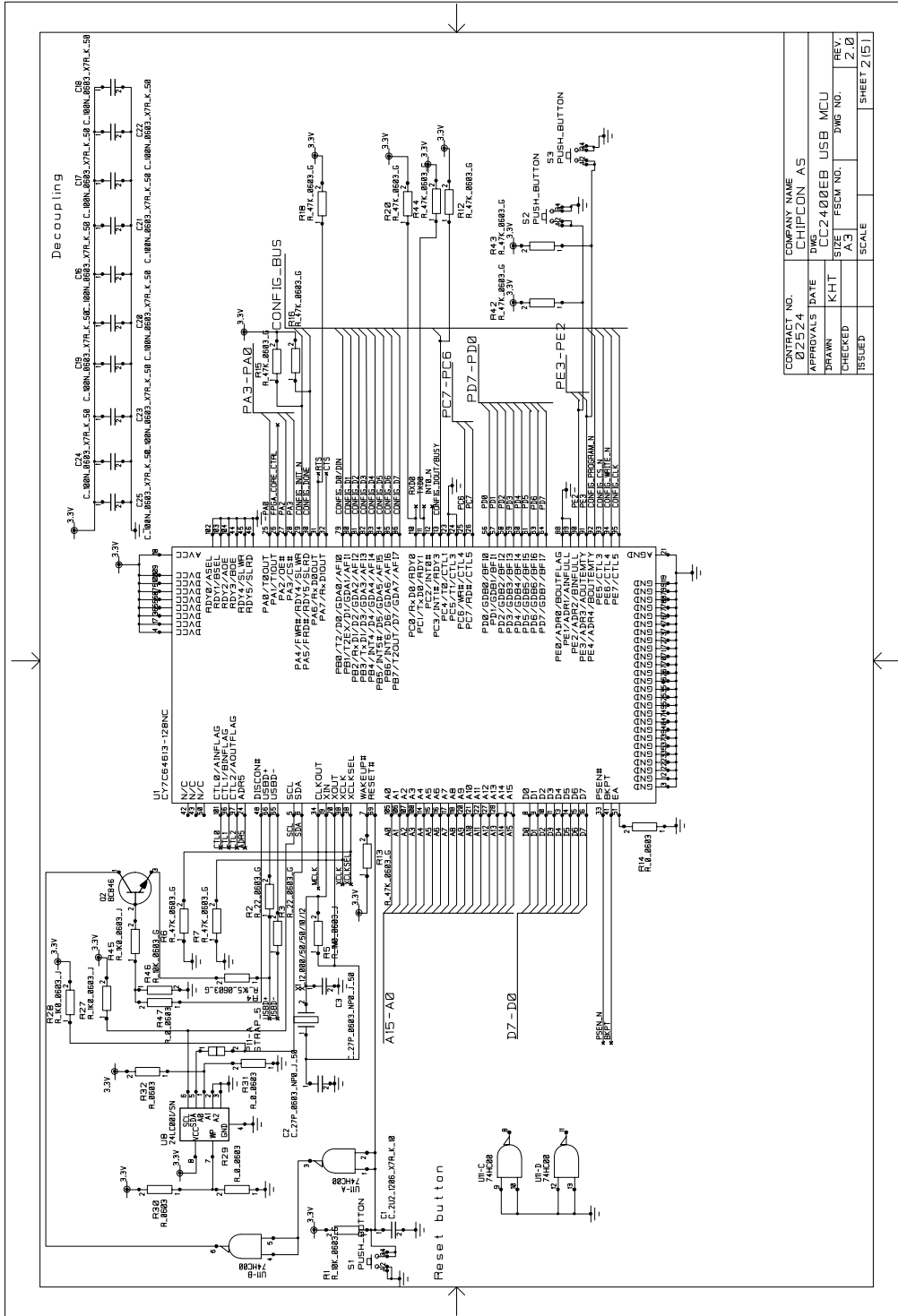

Figure 12: CC2400EB component placement, bottom side

**Schematics, CC2400EB**



CONTRACT NO.	02524	COMPANY NAME	CHIPCON AS
APPROVALS DATE		DATE	CC2400EB
DRAWN	KHT	SIZE	A3
CHECKED		FIG	
ISSUED		SCALE	
		DWG NO.	2.0
		REV.	115



CONTRACT NO. 02524		COMPANY NAME CHIPCON AS	
APPROVALS DATE		DATE	
DRAWN KHT	CHECKED A3	FILED	REV. 2.0
ISSUED		SCALE	
SHEET 2		SHEET 2	

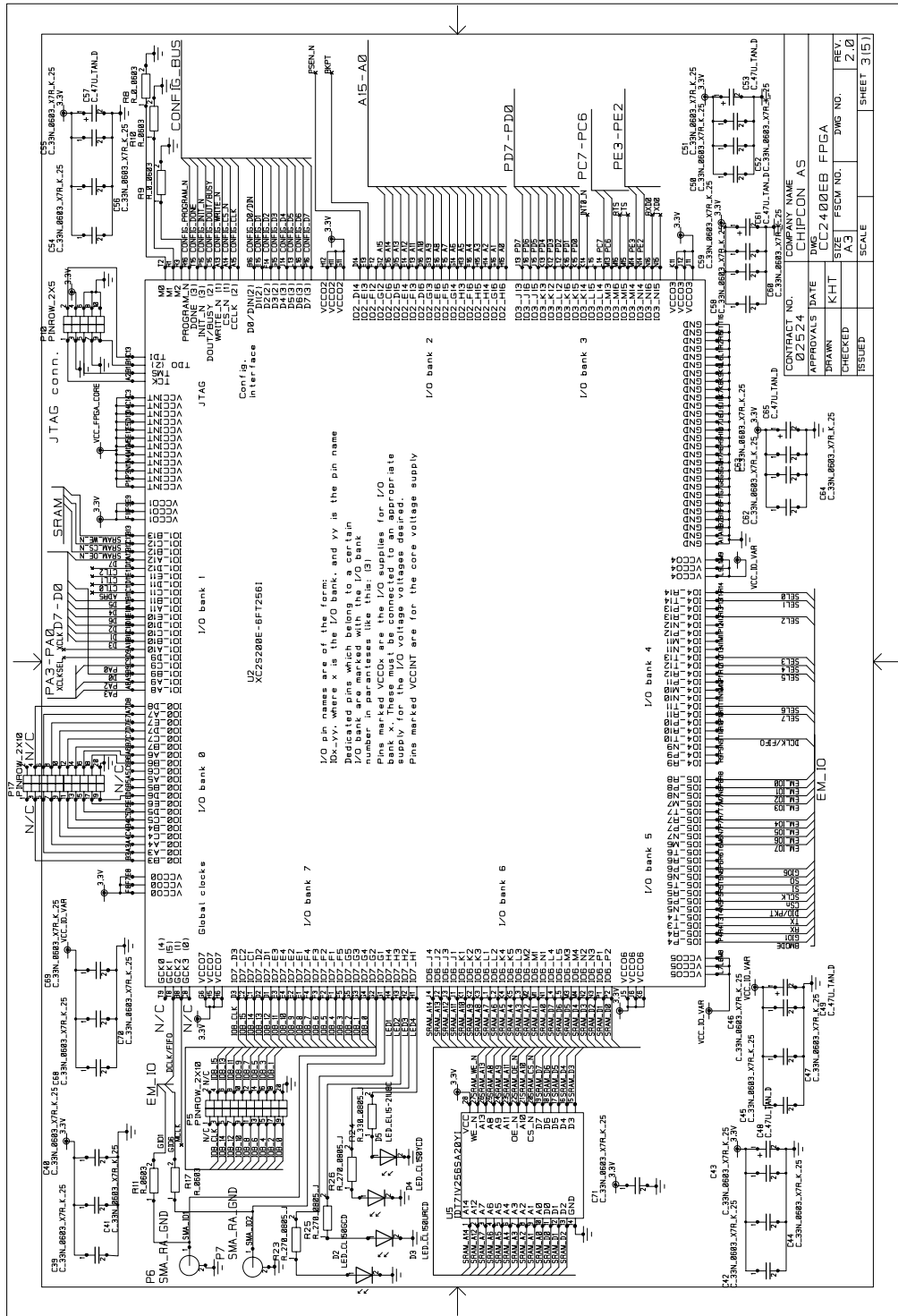

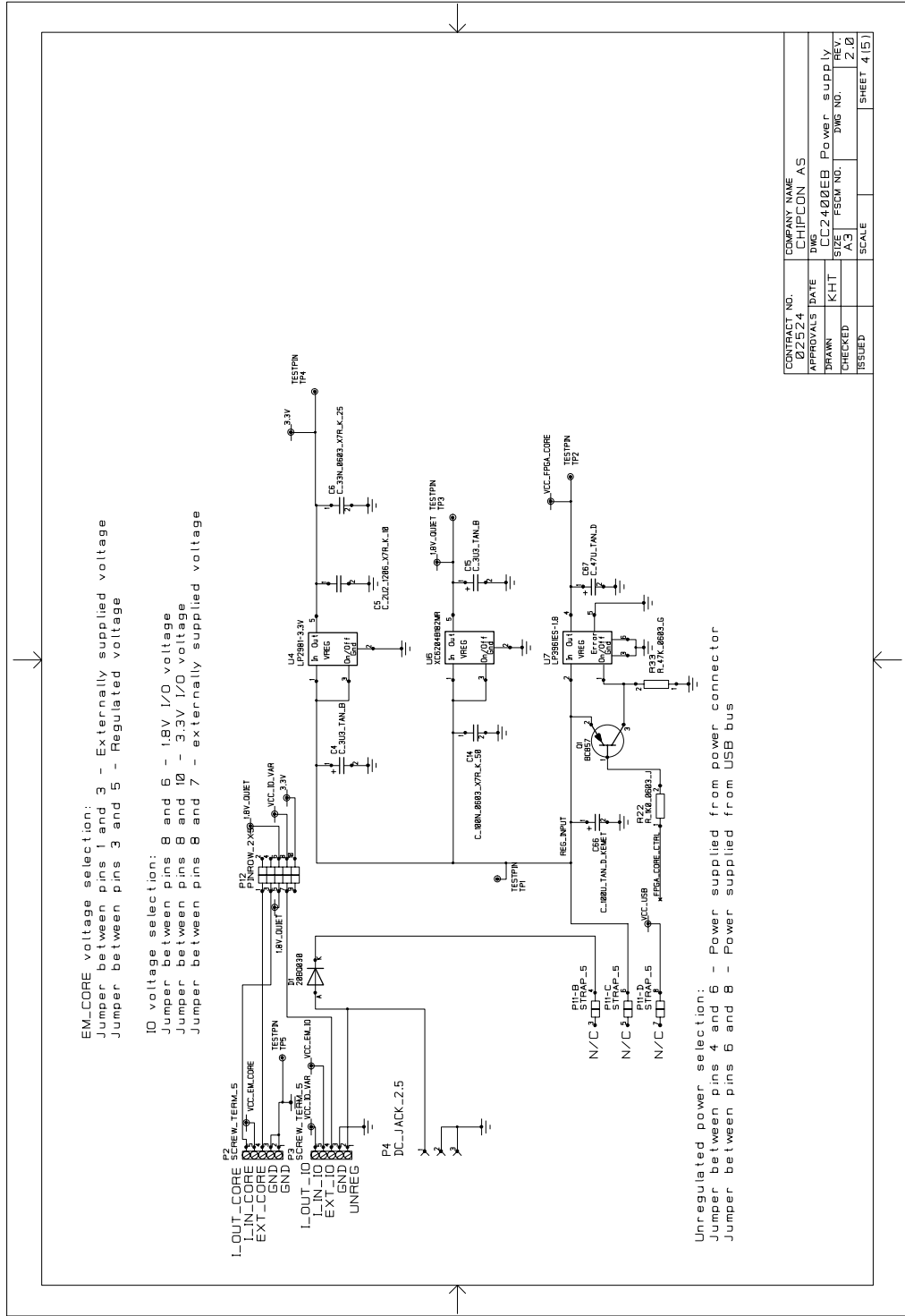

CONTRACT NO.	02524	COMPANY NAME	CHIPCON AS
APPROVALS DATE		DATE	20080808
DRAWN	KHT	DESIGNED BY	POWERSUPPLY
CHECKED		SIZE	A3
ISSUED		FEED NO.	20
		SCALE	
			SHEET 4 (5)

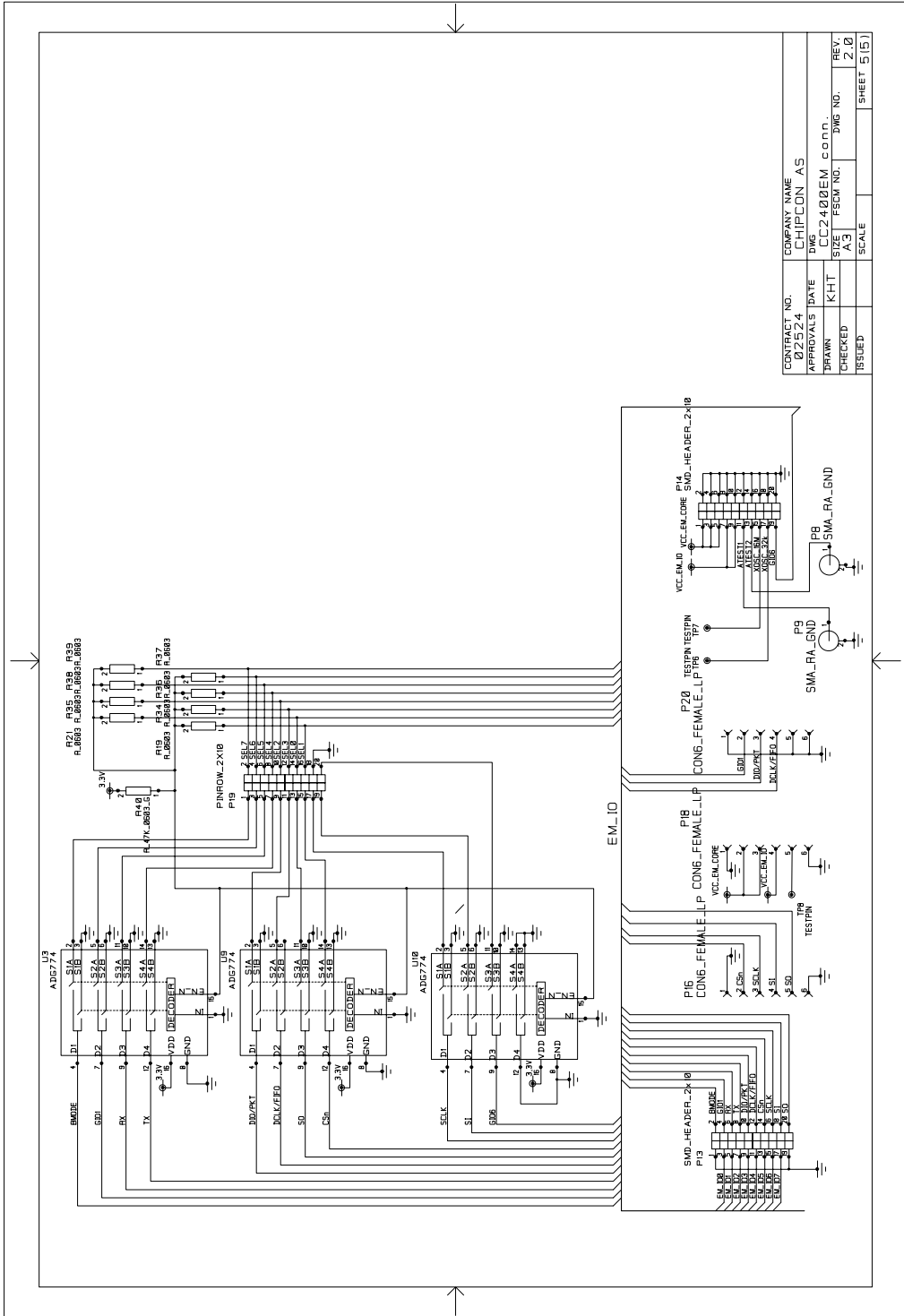

CONTRACT NO.	02524	COMPANY NAME	CHIPCON AS
APPROVALS DATE		DRW	C240EM
DRAWN	KHT	DESIGNER	CCO
CHECKED		SIZE	A3
ISSUED		PAGE NO.	20
		REV.	515
		SCALE	
		SHEET NO.	515



**Bill of Materials, CC2400EB**

<b>Bill of materials, CC2400EB Evaluation Board</b>			
<i>Reference</i>	<i>Description</i>	<i>Value</i>	<i>Part</i>
C1	Capacitor 1206	2.2 $\mu$ F, 10%	C_2U2_1206_X7R_K_10
C2	Capacitor 0603	27 pF, 5%	C_27P_0603_NP0_J_50
C3	Capacitor 0603	27 pF, 5%	C_27P_0603_NP0_J_50
C4	Capacitor, tantal	3.3 $\mu$ F	C_3U3_TAN_B
C5	Capacitor 1206	2.2 $\mu$ F, 10%	C_2U2_1206_X7R_K_10
C6	Capacitor 0603	33 nF, 10%	C_33N_0603_X7R_K_25
C14	Capacitor 0603	100 nF, 10%	C_100N_0603_X7R_K_50
C15	Capacitor, tantal	3.3 $\mu$ F	C_3U3_TAN_B
C16	Capacitor 0603	100 nF, 10%	C_100N_0603_X7R_K_50
C17	Capacitor 0603	100 nF, 10%	C_100N_0603_X7R_K_50
C18	Capacitor 0603	100 nF, 10%	C_100N_0603_X7R_K_50
C19	Capacitor 0603	100 nF, 10%	C_100N_0603_X7R_K_50
C20	Capacitor 0603	100 nF, 10%	C_100N_0603_X7R_K_50
C21	Capacitor 0603	100 nF, 10%	C_100N_0603_X7R_K_50
C22	Capacitor 0603	100 nF, 10%	C_100N_0603_X7R_K_50
C23	Capacitor 0603	100 nF, 10%	C_100N_0603_X7R_K_50
C24	Capacitor 0603	100 nF, 10%	C_100N_0603_X7R_K_50
C25	Capacitor 0603	100 nF, 10%	C_100N_0603_X7R_K_50
C26	Capacitor 0603	33 nF, 10%	C_33N_0603_X7R_K_25
C27	Capacitor 0603	33 nF, 10%	C_33N_0603_X7R_K_25
C28	Capacitor 0603	33 nF, 10%	C_33N_0603_X7R_K_25
C29	Capacitor 0603	33 nF, 10%	C_33N_0603_X7R_K_25
C30	Capacitor 0603	33 nF, 10%	C_33N_0603_X7R_K_25
C31	Capacitor 0603	33 nF, 10%	C_33N_0603_X7R_K_25
C32	Capacitor 0603	33 nF, 10%	C_33N_0603_X7R_K_25
C33	Capacitor 0603	33 nF, 10%	C_33N_0603_X7R_K_25
C34	Capacitor 0603	33 nF, 10%	C_33N_0603_X7R_K_25
C35	Capacitor 0603	33 nF, 10%	C_33N_0603_X7R_K_25
C36	Capacitor 0603	33 nF, 10%	C_33N_0603_X7R_K_25
C37	Capacitor 0603	33 nF, 10%	C_33N_0603_X7R_K_25
C38	Capacitor, tantal	47 $\mu$ F	C_47U_TAN_D
C39	Capacitor 0603	33 nF, 10%	C_33N_0603_X7R_K_25
C40	Capacitor 0603	33 nF, 10%	C_33N_0603_X7R_K_25
C41	Capacitor 0603	33 nF, 10%	C_33N_0603_X7R_K_25

Comment [C1]:

Bill of materials, CC2400EB Evaluation Board			
Reference	Description	Value	Part
C42	Capacitor 0603	33 nF, 10%	C_33N_0603_X7R_K_25
C43	Capacitor 0603	33 nF, 10%	C_33N_0603_X7R_K_25
C44	Capacitor 0603	33 nF, 10%	C_33N_0603_X7R_K_25
C45	Capacitor 0603	33 nF, 10%	C_33N_0603_X7R_K_25
C46	Capacitor 0603	33 nF, 10%	C_33N_0603_X7R_K_25
C47	Capacitor 0603	33 nF, 10%	C_33N_0603_X7R_K_25
C48	Capacitor, tantal	47 $\mu$ F	C_47U_TAN_D
C49	Capacitor, tantal	47 $\mu$ F	C_47U_TAN_D
C50	Capacitor 0603	33 nF, 10%	C_33N_0603_X7R_K_25
C51	Capacitor 0603	33 nF, 10%	C_33N_0603_X7R_K_25
C52	Capacitor 0603	33 nF, 10%	C_33N_0603_X7R_K_25
C53	Capacitor, tantal	47 $\mu$ F	C_47U_TAN_D
C54	Capacitor 0603	33 nF, 10%	C_33N_0603_X7R_K_25
C55	Capacitor 0603	33 nF, 10%	C_33N_0603_X7R_K_25
C56	Capacitor 0603	33 nF, 10%	C_33N_0603_X7R_K_25
C57	Capacitor, tantal	47 $\mu$ F	C_47U_TAN_D
C58	Capacitor 0603	33 nF, 10%	C_33N_0603_X7R_K_25
C59	Capacitor 0603	33 nF, 10%	C_33N_0603_X7R_K_25
C60	Capacitor 0603	33 nF, 10%	C_33N_0603_X7R_K_25
C61	Capacitor, tantal	47 $\mu$ F	C_47U_TAN_D
C62	Capacitor 0603	33 nF, 10%	C_33N_0603_X7R_K_25
C63	Capacitor 0603	33 nF, 10%	C_33N_0603_X7R_K_25
C64	Capacitor 0603	33 nF, 10%	C_33N_0603_X7R_K_25
C65	Capacitor, tantal	47 $\mu$ F	C_47U_TAN_D
C66	Capacitor, tantal, low ESR	100 $\mu$ F	C_100U_TAN_D_KEMET (Kemet T494D107M010AS)
C67	Capacitor, tantal	47 $\mu$ F	C_47U_TAN_D
C68	Capacitor 0603	33 nF, 10%	C_33N_0603_X7R_K_25
C69	Capacitor 0603	33 nF, 10%	C_33N_0603_X7R_K_25
C70	Capacitor 0603	33 nF, 10%	C_33N_0603_X7R_K_25
C71	Capacitor 0603	33 nF, 10%	C_33N_0603_X7R_K_25
C100	Capacitor 0603	100 nF, 10%	C_100N_0603_X7R_K_50
C101	Capacitor 0603	100 nF, 10%	C_100N_0603_X7R_K_50
C102	Capacitor 0603	100 nF, 10%	C_100N_0603_X7R_K_50
C103	Capacitor low impedance	470 $\mu$ F, electrolytic	C_470U_8_CVAX (Sanyo CV-AX 8x10,2)

Bill of materials, CC2400EB Evaluation Board			
Reference	Description	Value	Part
C104	Capacitor 0603	100 nF, 10%	C_100N_0603_X7R_K_50
C105	Capacitor 0603	33 nF, 10%	C_33N_0603_X7R_K_25
C106	Capacitor 1206	2.2 $\mu$ F, 10%	C_2U2_1206_X7R_K_10
D1	Schottky diode, 2A		20BQ030, International Rectifier
D2	LED, green, SMD		LED_CL150GCD, Citizen
D3	LED, red, SMD		LED_CL150URCD, Citizen
D4	LED, yellow, SMD		LED_CL150YCD, Citizen
D5	LED, blue, SMD		LED_EL15-21UBC, Everlight
H1	Circuit board support		Distance 12.5mm
H2	Circuit board support		Distance 12.5mm
H3	Circuit board support		Distance 12.5mm
H4	Circuit board support		Distance 12.5mm
P1	D-SUB, 9 pin, female		DSUB_9F
P2	5-pin terminal, screw		SCREW_TERM_5
P3	5-pin terminal, screw		SCREW_TERM_5
P4	DC jack, 2.5mm center pin		DC_JACK_2.5
P5	Pin row connector, 2x10		PINROW_2_10
P6	SMA connector		SMA (Right angle)
P7	SMA connector		SMA (Right angle)
P8	SMA connector		SMA (Right angle)
P9	SMA connector		SMA (Right angle)
P10	Pin row connector, 2x5		PINROW_2X5
P11	Pin row connector, 2x5		PINROW_2X5
P12	Pin row connector, 2x5		PINROW_2X5
P13	SMD pinrow header		SMD_HEADER_2x10 (Samtec TFM-110-02-S-D-A-K-TR)
P14	SMD pinrow header		SMD_HEADER_2x10 (Samtec TFM-110-02-S-D-A-K-TR)
P15	USB B-type connector		USB_B (AMP 787780-1)
P16	Low-profile pin row connector, 1x6		CON6_FEMALE_LP (Preci-DIP 801-91-006-10-012)
P17	Pin row connector, 2x10		PINROW_2X10
P18	Low-profile pin row connector, 1x6		CON6_FEMALE_LP (Preci-DIP 801-91-006-10-012)

Comment [C2]:

Bill of materials, CC2400EB Evaluation Board			
Reference	Description	Value	Part
P19	Do not mount		DNM
P20	Low-profile pin row connector, 1x6		CON6_FEMALE_LP (Preci-DIP 801-91-006-10-012)
Q1	PNP, general-purpose		BC857B (Philips)
Q2	NPN, small-signal		BC846B (Philips)
R1	Resistor 0603	10 k $\Omega$ , 2%	R_10K_0603_G
R2	Resistor 0603	22 $\Omega$ , 2%	R_22_0603_G
R3	Resistor 0603	22 $\Omega$ , 2%	R_22_0603_G
R4	Resistor 0603	1.5 k $\Omega$ , 2%	R_1K5_0603_G
R5	Resistor 0603	1 M $\Omega$ , 5%	R_1M0_0603_J
R6	Resistor 0603	47 k $\Omega$ , 2%	R_47K_0603_G
R7	Resistor 0603	47k $\Omega$ , 2%	R_47K_0603_G
R8	Resistor 0603	0 $\Omega$	R_0_0603
R9	Resistor 0603	0 $\Omega$	R_0_0603
R10	Do Not Mount		DNM
R11	Do Not Mount		DNM
R12	Resistor 0603	47k $\Omega$ , 2%	R_47K_0603_G
R13	Resistor 0603	47k $\Omega$ , 2%	R_47K_0603_G
R14	Resistor 0603	0 $\Omega$	R_0_0603
R15	Resistor 0603	47 k $\Omega$ , 2%	R_47K_0603_G
R16	Resistor 0603	47 k $\Omega$ , 2%	R_47K_0603_G
R17	Do Not Mount		DNM
R18	Resistor 0603	47k $\Omega$ , 2%	R_47K_0603_G
R19	Do Not Mount		DNM
R20	Resistor 0603	47 k $\Omega$ , 2%	R_47K_0603_G
R21	Do Not Mount		DNM
R22	Resistor 0603	1 k $\Omega$ , 5%	R_1K0_0605_J
R23	Resistor 0805	270 $\Omega$ , 5%	R_270_0805_J
R24	Resistor 0805	330 $\Omega$ , 5%	R_330_0805_J
R25	Resistor 0805	270 $\Omega$ , 5%	R_270_0805_J
R26	Resistor 0805	270 $\Omega$ , 5%	R_270_0805_J
R27	Resistor 0603	1 k $\Omega$ , 5%	R_1K0_0605_J
R28	Resistor 0603	1 k $\Omega$ , 5%	R_1K0_0605_J
R29	Resistor 0603	0 $\Omega$	R_0_0603
R30	Do Not Mount		DNM

Bill of materials, CC2400EB Evaluation Board			
Reference	Description	Value	Part
R31	Resistor 0603	0 $\Omega$	R_0_0603
R32	Do Not Mount		DNM
R33	Resistor 0603	47 k $\Omega$ , 2%	R_47K_0603_G
R34	Do Not Mount		DNM
R35	Do Not Mount		DNM
R36	Do Not Mount		DNM
R37	Do Not Mount		DNM
R38	Do Not Mount		DNM
R39	Do Not Mount		DNM
R40	Resistor 0603	47 k $\Omega$ , 2%	R_47K_0603_G
R41	Resistor 0603	0 $\Omega$	R_0_0603
R42	Resistor 0603	47 k $\Omega$ , 2%	R_47K_0603_G
R43	Resistor 0603	47 k $\Omega$ , 2%	R_47K_0603_G
R44	Resistor 0603	47 k $\Omega$ , 2%	R_47K_0603_G
R45	Resistor 0603	1 k $\Omega$ , 5%	R_1K0_0605_J
R46	Resistor 0603	10 k $\Omega$ , 2%	R_10K_0603_G
R47	Resistor 0603	0 $\Omega$	R_0_0603
R100	Resistor 0603	0 $\Omega$	R_0_0603
R101	Resistor 0603	0 $\Omega$	R_0_0603
S1	Push button, SMD		SKHUAF, Alps
S2	Push button, SMD		SKHUAF, Alps
S3	Push button, SMD		SKHUAF, Alps
TP1	Test point		TESTPIN
TP2	Test point		TESTPIN
TP3	Test point		TESTPIN
TP4	Test point		TESTPIN
TP5	Test point		TESTPIN
TP6	Test point		TESTPIN
TP7	Test point		TESTPIN
TP8	Test point		TESTPIN
U1	EZ-USB MCU		CY7C64613-128NC, Cypress
U2	Spartan IIE FPGA		XC2S200E-6FT256I, Xilinx
U3	Do Not Mount		DNM
U4	3.3 V low drop-out regulator		LP2981AIM5-3.3, National Semiconductor

<b>Bill of materials, CC2400EB Evaluation Board</b>			
<i>Reference</i>	<i>Description</i>	<i>Value</i>	<i>Part</i>
U5	32 kB SRAM		IDT71V256SA20YI, IDT
U6	1.8 V low drop-out regulator		XC6204B182MR, Torex
U7	1.8 V low drop-out regulator, 800 mA		LP3961ES-1.8, National Semiconductor
U8	16 byte I2C EEPROM		24LC00I/SN, Microchip
U9	Do Not Mount		DNM
U10	Do Not Mount		DNM
U11	Quad NAND gate		74HC00D, Philips
U100	RS-232 Transceiver, 3-5V		MAX3243EEWI, Maxim
X1	12 MHz crystal, HC-49SMD, 50/50 ppm, 12 pF		X_12.000/50/50/10/12

## Using the Development Kit

The Development Kit is useful for providing hands-on experience with the CC2400 for both software and hardware developers. The plug-in Evaluation Module provides flexibility; it can operate both in a stand-alone fashion and together with the Evaluation Board. Using the Evaluation Board, it is easy to interface the CC2400 with both test equipment and additional application circuitry without having to make a PCB from scratch. Below we will highlight the most useful setups.

### CC2400 RF Evaluation using SmartRF® Studio

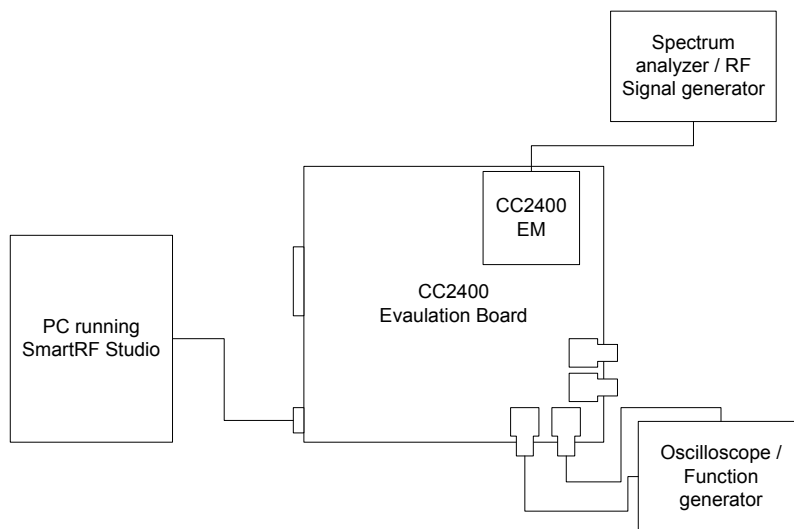

**Figure 13: RF Evaluation using SmartRF® Studio**

Using the setup shown in Figure 13, the RF performance of the CC2400 can be evaluated. Use the supplied cable to connect the USB port of the CC2400EB to the USB port of a PC running SmartRF® Studio. You can then use SmartRF® Studio to control all the RF parameters of the CC2400.

SmartRF® Studio can be used to perform a wide variety of RF tests, including link tests. Using two CC2400EBs, it is possible to send data from one PC to another. It is also possible to test a frequency-hopping link in the same fashion. Please refer to the SmartRF® Studio documentation for more information.

When the CC2400EB board is connected to a PC, the PC will load the USB driver for the board (SmartRF® Studio must be installed on the PC). Once the driver has loaded, it will update the FPGA and microcontroller, and the LEDs will start flashing. The LED flashing will stop if one of the buttons on the board is pressed, or when SmartRF® Studio is started.

When SmartRF Studio is running, the LEDs are used to indicate the FH network ID for the board. The ID is shown as a binary number, with the red LED representing the least significant bit (LSB), the yellow LED representing bit 1, and the green LED representing the most significant bit (MSB). When FH network is active, the blue LED toggles each time the status is read from the PC.

**Important:** *The use of radio transceivers is regulated by international and national rules. Before transmitting an RF signal on an antenna, please contact your local telecommunication authorities to make sure that you are licensed to operate the transceiver.*

### Using the CC2400DK for prototyping

The CC2400EM module contains the CC2400 and all external components required. All CC2400 signals are available at the SMD connectors on the bottom side of the module. The modules can be easily plugged into a prototype PCB containing the rest of the system. The SMD connectors used on the CC2400EM are manufactured by Samtec (<http://www.samtec.com/>), please refer to the CC2400EB bill of materials for the part number of the connector that will interface with the connectors on the EM.

It is also possible to do prototyping by connecting any microcontroller development kit to the CC2400EM through Test Port 1. The FPGA must then be programmed using the SmartRF Studio “Load FPGA Configuration” function at startup. The “fpga\_cc2400\_uc\_prototyping\_1\_0.bin” FPGA file is downloadable from the Chipcon website. All LEDs will be turned off after programming this FPGA. The FPGA will give access to all CC2400 digital pins on Test Port 1, as shown below.

Test Port 1 Pin Number	Test Port 1 (to / from uC)
1	N/C
2	N/C
3	N/C
4	DIO/PKT (to uC)
5	HighZ
6	HighZ
7	HighZ
8	DCLK/FIFO (to uC)
9	HighZ
10	HighZ
11	HighZ
12	CSn (from uC)
13	SCLK (from uC)
14	SI (from uC)
15	SO (to uC)
16	GIO1 (to uC)
17	GIO6 (to uC)
18	TX (from uC)
19	RX (from uC)
20	GND

Test Port 2 contains the same pins, except these are all outputs from the FPGA. Test Port 2 may be connected to a Logic Analyzer for software debugging purposes.

It should be noted that when using a ribbon cable from Test Port 1 to the MCU, one can experience that some of the signals are interfering with each other.

A solution would be to use single wires instead, or use some form of shielded ribbon cable.



## Troubleshooting

### It does not work

- Make sure that either a jumper or an amperemeter is connected between the IOI and II terminals and the IIC and IOC terminals on the power connector.
- Make sure that the power supply is connected to the correct pins on the power connector.
- Is the supply voltage correctly polarized? If not, the protection diode will prevent any current from flowing. + and – are indicated on the PCB. On the DC jack, the tip is + and the ring is –.
- Please note that the CC2400EB must be connected to a PC for proper operation. The FPGA and microcontroller are RAM-based, and firmware must be loaded from a PC when power is applied to the board.
- If the USB driver is loaded correctly, you should see the LEDs on the CC2400EB flash. The LEDs will stop flashing when one of the buttons on the CC2400EB is pressed or when SmartRF® Studio is started.

### SmartRF® Studio does not recognize the CC2400EB

- Make sure that you have installed SmartRF® Studio using the installation program.
- Make sure that the USB port on your computer is installed correctly (try another USB device with the same port). Also note that USB only works correctly with Windows 98, ME, 2000, XP or newer.
- Please note that SmartRF® Studio can only communicate with the CC2400EB via the USB port. The serial port *cannot* be used to communicate with the CC2400EB.

## Document History

Revision	Date	Description/Changes
1.0	2003-10-01	Initial release.
1.1	2004-04-19	Added information about FPGA configuration for prototyping with an external microcontroller.  Minor corrections.  C421 and C431 changed to 27 pF.

## Disclaimer

Chipcon AS believes the information contained herein is correct and accurate at the time of this printing. However, Chipcon AS reserves the right to make changes to this product without notice. Chipcon AS does not assume any responsibility for the use of the described product.; neither does it convey any license under its patent rights, or the rights of others. The latest updates are available at the Chipcon website or by contacting Chipcon directly.

As far as possible, major changes of product specifications and functionality will be stated in product specific Errata Notes published at the Chipcon website. Customers are encouraged to sign up for the Developer's Newsletter in order to receive the most recent updates on products and support tools.

When a product is discontinued this will be done according to Chipcon's procedure for obsolete products as described in Chipcon's Quality Manual. This includes informing about last-time-buy options. The Quality Manual can be downloaded from Chipcon's website.

## Trademarks

*SmartRF*<sup>®</sup> is a registered trademark of Chipcon AS. SmartRF<sup>®</sup> is Chipcon's RF technology platform with RF library cells, modules and design expertise. Based on SmartRF<sup>®</sup> technology Chipcon develops standard component RF circuits as well as full custom ASICs based on customer requirements and this technology.

All other trademarks, registered trademarks and product names are the sole property of their respective owners.

© 2003, Chipcon AS. All rights reserved.

## Address Information

Web site: <http://www.chipcon.com>  
E-mail: [wireless@chipcon.com](mailto:wireless@chipcon.com)  
Technical Support Email: [support@chipcon.com](mailto:support@chipcon.com)  
Technical Support Hotline: +47 22 95 85 45

### Headquarters:

Chipcon AS  
Gaustadalléen 21  
NO-0349 Oslo  
NORWAY  
Tel: +47 22 95 85 44  
Fax: +47 22 95 85 46  
E-mail: [wireless@chipcon.com](mailto:wireless@chipcon.com)

### US Offices:

Chipcon Inc., Western US Sales Office  
19925 Stevens Creek Blvd.  
Cupertino, CA 95014-2358  
USA  
Tel: +1 408 973 7845  
Fax: +1 408 973 7257  
Email: [USsales@chipcon.com](mailto:USsales@chipcon.com)

Chipcon Inc., Eastern US Sales Office  
35 Pinehurst Avenue  
Nashua, New Hampshire, 03062  
USA  
Tel: +1 603 888 1326  
Fax: +1 603 888 4239  
Email: [eastUSsales@chipcon.com](mailto:eastUSsales@chipcon.com)

### Sales Office Germany:

Chipcon AS  
Riedberghof 3  
D-74379 Ingersheim  
GERMANY  
Tel: +49 7142 9156815  
Fax: +49 7142 9156818  
Email: [Germanysales@chipcon.com](mailto:Germanysales@chipcon.com)

### Strategic Automotive Center:

Chipcon AS  
Hechtseestrasse 16  
D-83022 Rosenheim  
GERMANY  
Tel: +49 8031 2227 660  
Fax: +49 8031 2227 661  
Email: [automotive@chipcon.com](mailto:automotive@chipcon.com)

### Sales Office Asia :

Chipcon Asia Pacific  
37F, Asem Tower  
159-1 Samsung-dong, Kangnam-ku  
Seoul 135-798 Korea  
Tel: +82 2 6001 3888  
Fax: +82 2 6001 3711  
Email: [Asiasales@chipcon.com](mailto:Asiasales@chipcon.com)