



The Future of Analog IC Technology[®]

EVM3682-RE-00A

18V 10A Step-Down Power Module Evaluation Board

NOT RECOMMENDED FOR NEW DESIGNS, REFER TO EVM3683-10-MN-01A

DESCRIPTION

The EVM3682-RE-00A is used for demonstrating the performance of MPS' MPM3682, a 10A step-down power module with built-in power MOSFETs and power inductor.

High power efficiency over a wide load range is achieved by scaling down the switching frequency at light load to reduce the switching related loss by constant on time control. Over-Current-Protection, Over-Voltage Protection, Under-Voltage Protection, and thermal shutdown provide reliable operation.

MPM3682 is available in QFN 12x12x4mm package.

ELECTRICAL SPECIFICATION

Parameter	Symbol	Value	Units
Input Voltage	V _{IN}	8-18	V
Output Voltage	V _{OUT}	1/1.2/1.5/1.8	V
Output Current	I _{OUT}	10	A

FEATURES

- Complete 10A DC-to-DC Solution
- Wide Input Voltage Range from 2.5V:
 - 2.5V to 18V with External 5V Bias
 - 4.5V to 18V with Internal Bias
- 1% Reference Voltage Over 0°C to 70°C Junction Temperature Range
- Adaptive COT Control for Ultrafast Transient Response
- Programmable Switching Frequency from 200KHz to 1MHz
- Support Pre-Bias Start Up
- Programmable Soft-Start Time with Default 3ms
- Non-latch OCP, OVP and Thermal Shutdown
- Output Adjustable from 0.65V to 5V
- 12 x 12 x 4 (mm) QFN package

APPLICATIONS

- Telecom and Networking Systems
- Base Stations
- Servers
- Personal Video Recorders
- Flat Panel Television and Monitors
- Distributed Power Systems

All MPS parts are lead-free and adhere to the RoHS directive. For MPS green status, please visit MPS website under Quality Assurance. "MPS" and "The Future of Analog IC Technology", are Registered Trademarks of Monolithic Power Systems, Inc.

EVM3682-RE-00A EVALUATION BOARD



Board Number	MPS IC Number
EVM3682-RE-00A	MPM3682GRE

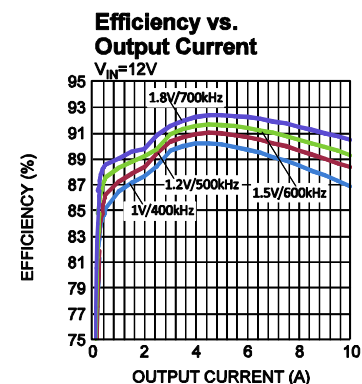

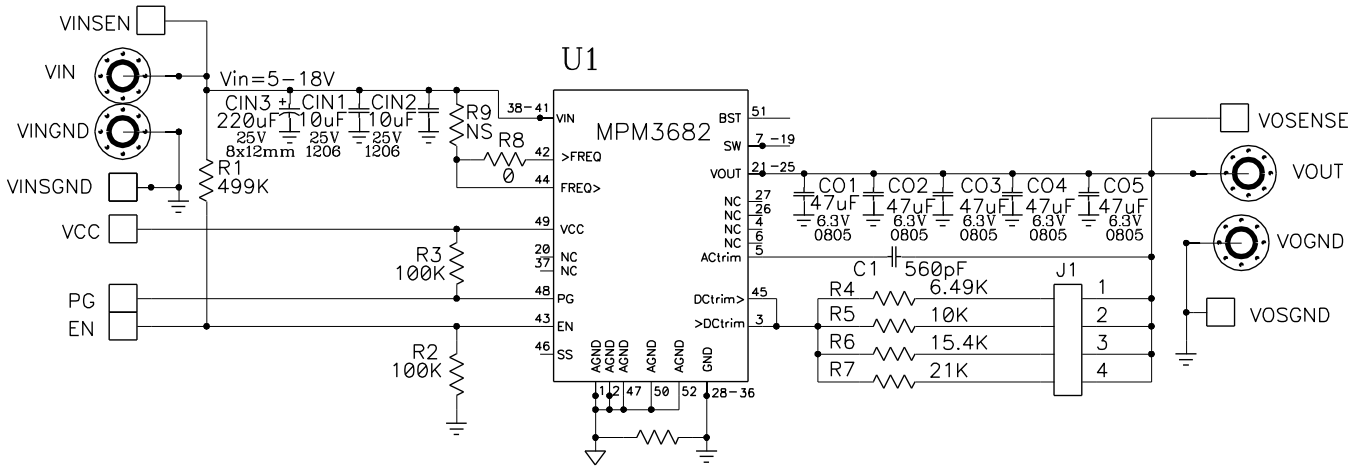
EVALUATION BOARD SCHEMATIC

J1				VOUT
1	2	3	4	1.0V
ON	OPEN	OPEN	OPEN	1.2V
OPEN	ON	OPEN	OPEN	1.5V
OPEN	OPEN	ON	OPEN	1.8V

EVM3682-RE-00A BILL OF MATERIALS

RefDes	Value	Description	Package	Manufacturer	Manufacturer P/N
C1	560pF	CAP, 25V, 5%, NP0	CAP0603	Murata	GRM1885C1E561JA01D
CIN1, CIN2	10μF	Capacitor, 25V, X7R, 10%	CAP1206	Murata	GRM31CR71E106KA12L
CIN3	220μF	220uF, 25V, 20%, 22mOhm ESR	SM8x12mm	Nichicon	PCV1E221MCL2GS
CO1, CO2, CO3, CO4, CO5	47μF	CAP, 4V, X5R, 20%	CAP0805	Murata	GRM21BR60G476ME15L
R1	499k	Film Res., 1%	0603	Yageo	RC0603FR-07499KL
R2, R3	100k	Film Res., 1%	0603	Yageo	RC0603FR-07100KL
R4	6.49k	Film Res., 1%	0603	Yageo	RC0603FR-076K49L
R5	10k	Film Res., 1%	0603	Yageo	RC0603FR-0710KL
R6	15.4k	Film Res., 1%	0603	Yageo	RC0603FR-0715K4L
R7	21k	Film Res., 1%	0603	Yageo	RC0603FR-0721KL
R8	0	Film Res., 1%	0603	Yageo	RC0603FR-070RL
R9	NS	Film Res., 1%	0603	Any	Any
U1	MPM3682	18V/10A Power Stage Module	QFN57-12X12mm	MPS	MPM3682GRE
Miscellaneous					
Banana Jack		Non-insulated Banana Jack	575-4	Keystone	575-4
J1		2mm, 8-pin Dual Row Header	4x2x2mm	Würth	620 008 211 21
Jumper		2mm Jumper	2x3.5mm	Würth	608 002 134 21
Test Point		2.54mm Pitch, 9-pin Header	2.54mmx9	Würth	613 009 111 21
Test Point		2.54mm Pitch, 3-pin Header	2.54mmx3	Würth	613 003 111 21

EVB TEST RESULTS

Performance waveforms are tested on the evaluation board.

$V_{IN}=12V$, $V_{OUT}=1.2V$, $T_A = 25^{\circ}C$, unless otherwise noted.

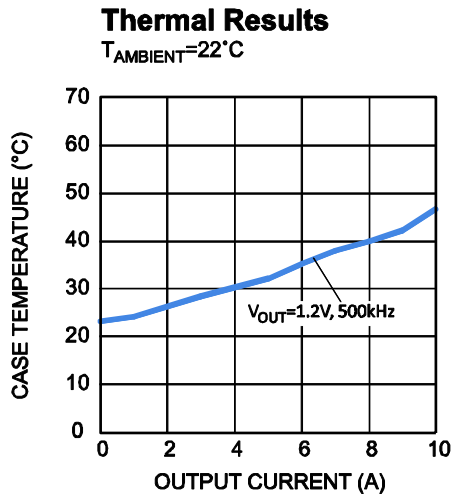
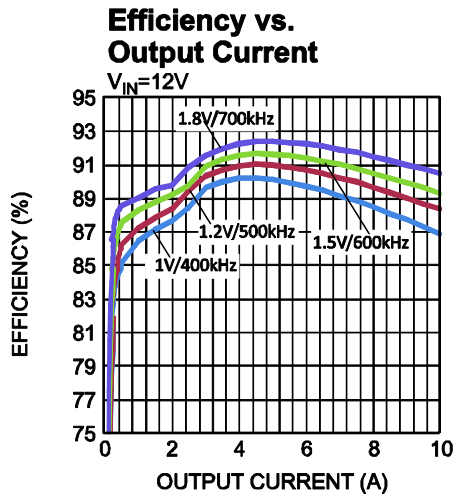

NOT RECOMMENDED FOR NEW DESIGNS, REFER TO EVM3683-10-MN-01A

EVB TEST RESULTS *(continued)*

Performance waveforms are tested on the evaluation board.

$V_{IN}=12V$, $V_{OUT}=1.2V$, $T_A = 25^{\circ}C$, unless otherwise noted.

Load Transient response

$I_{OUT}=1-8A @ 2.5A/\mu s$

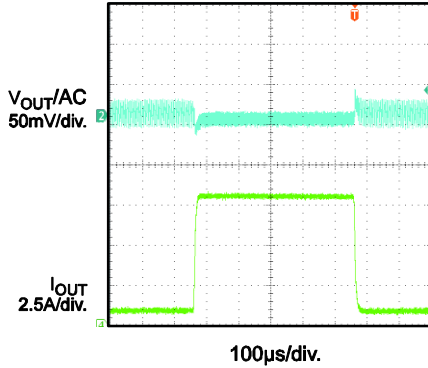

Power Up Through EN

0A

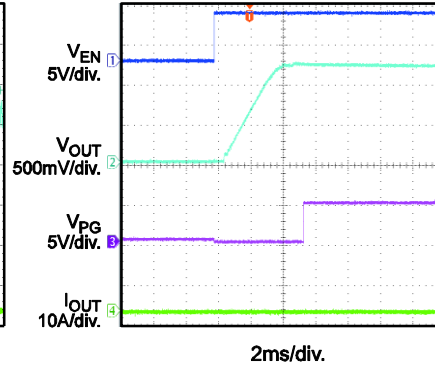

Power Up Through EN

10A

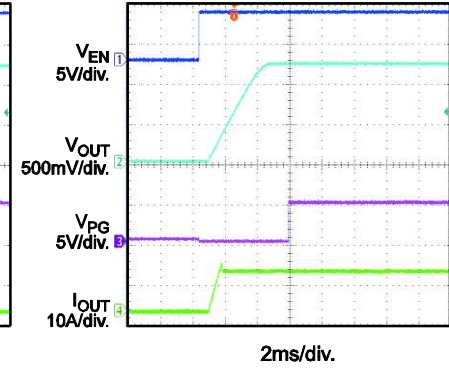

Power Up Through Input

0A

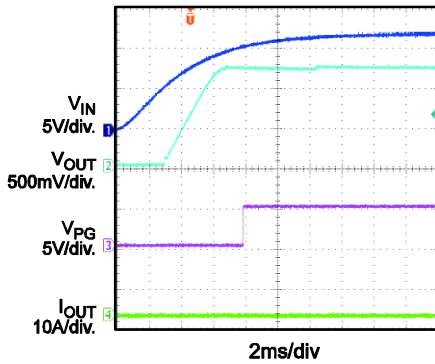

Power Up Through Input

10A

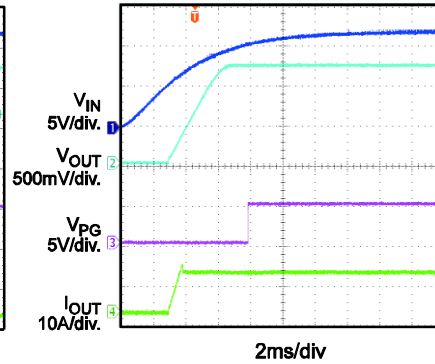

Output Ripple

0A

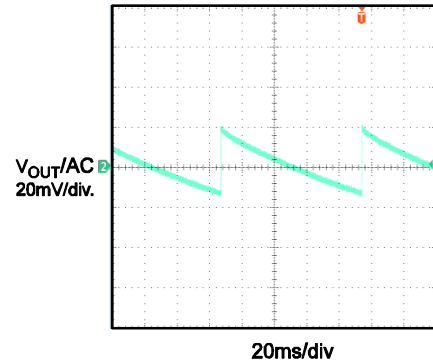

Output Ripple

10A

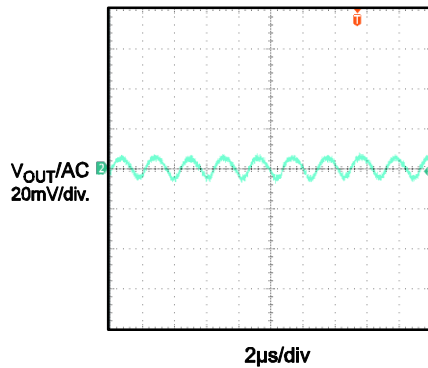

Over Current Protection

OCP

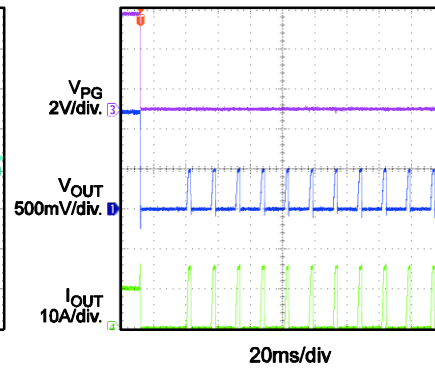

Over Current Protection

Recovery

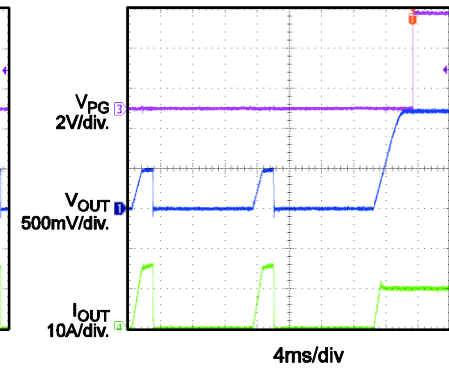

PRINTED CIRCUIT BOARD LAYER

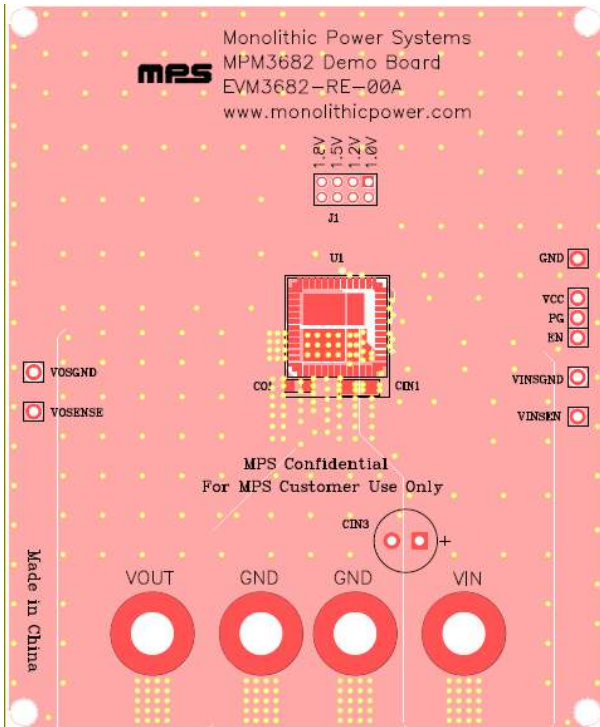

Figure 1: Top Silk Layer

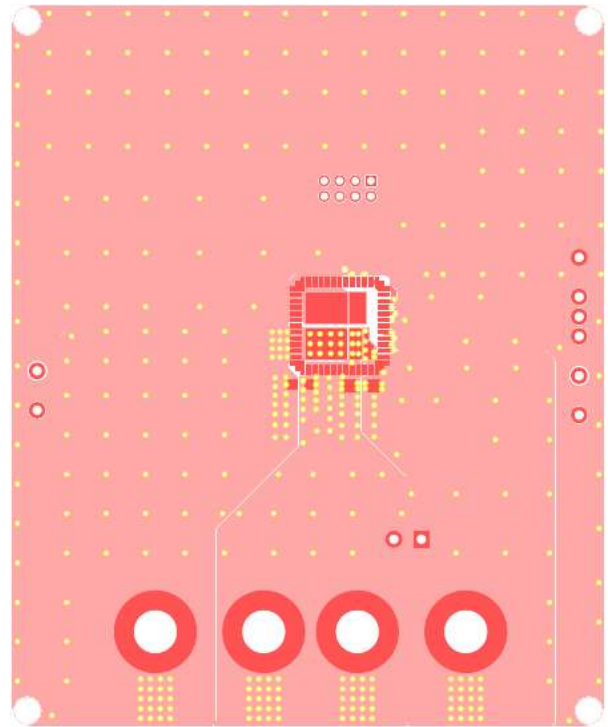

Figure 2: Top Layer

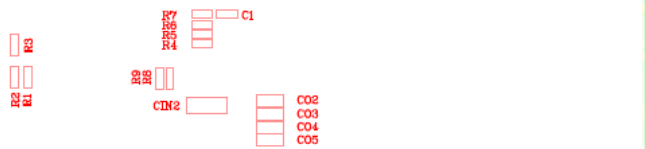

Figure 3: Bottom Silk Layer

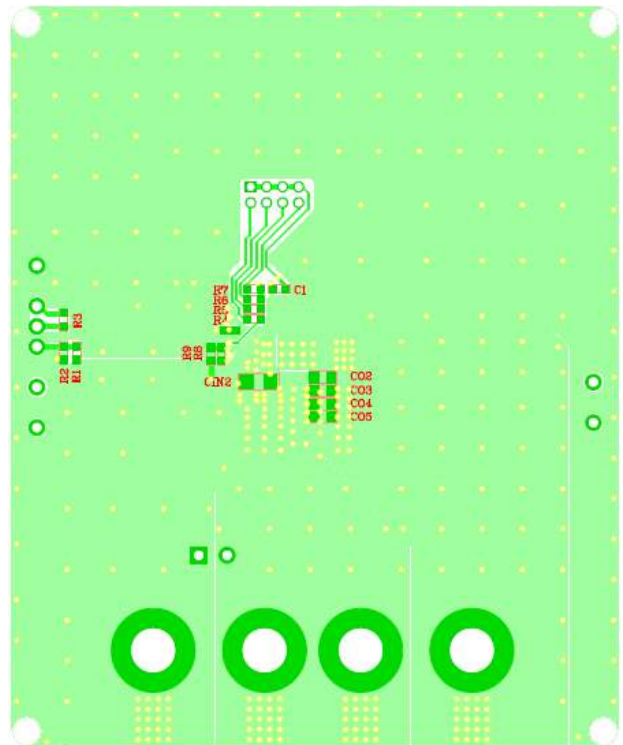

Figure 4: Bottom Layer

QUICK START GUIDE

The output voltage of this board is set externally which can be regulated as 1V, 1.2V, 1.5V or 1.8V by choosing the jumper position. The input voltage can range from 8V to 18V. The minimum 8V input voltage is limited by the EN signal, which is derived from VIN through a resistor divider. Lower input voltage (as low as 4.5V) can be set by fine tuning the resistor divider values. The following is the procedures to turn on the power module.

1. Put the jumper to the position to the desired output voltage setting.
2. Connect the positive and negative terminals of the load to the VOUT and GND pins, respectively.
3. Preset the power supply output between 8V and 18V, and then turn off the power supply. Make sure the power supply has high enough current limit to supply the current.
4. Connect the positive and negative terminals of the power supply output to the VIN and GND pins, respectively.
5. Turn the power supply on. The power module will automatically start up.

NOTICE: The information in this document is subject to change without notice. Please contact MPS for current specifications. Users should warrant and guarantee that third party Intellectual Property rights are not infringed upon when integrating MPS products into any application. MPS will not assume any legal responsibility for any said applications.