

# BMD-360

## Stand-alone Bluetooth 5.1 low energy and IEEE 802.15.4 module

Data sheet



### Abstract

This technical data sheet describes the BMD-360 stand-alone Bluetooth® low energy and IEEE 802.15.4 module. The OEMs can embed their own application on top of the integrated Bluetooth low energy stack using Nordic SDK integrated development environment (IDE).

# Document information

<b>Title</b>	<b>BMD-360</b>	
<b>Subtitle</b>	Stand-alone Bluetooth 5.1 low energy and IEEE 802.15.4 module	
<b>Document type</b>	Data sheet	
<b>Document number</b>	UBX-19039466	
<b>Revision and date</b>	R08	6-May-2022
<b>Disclosure restriction</b>	C1-Public	

<b>Product status</b>	<b>Corresponding content status</b>	
<b>Functional sample</b>	Draft	For functional testing. Revised and supplementary data will be published later.
<b>In development / Prototype</b>	Objective specification	Target values. Revised and supplementary data will be published later.
<b>Engineering sample</b>	Advance information	Data based on early testing. Revised and supplementary data will be published later.
<b>Initial production</b>	Early production information	Data from product verification. Revised and supplementary data may be published later.
<b>Mass production / End of life</b>	Production information	Document contains the final product specification.

This document applies to the following products:

<b>Product name</b>	<b>Type number</b>	<b>IN/PCN reference</b>	<b>Product status</b>
BMD-360	BMD-360-A-R-00	N/A	Obsolete
BMD-360	BMD-360-A-R-10	UBX-20009871	Initial production
BMD-360	BMD-360-A-R-20	UBX- 21028574	Initial production

u-blox or third parties may hold intellectual property rights in the products, names, logos and designs included in this document. Copying, reproduction, modification or disclosure to third parties of this document or any part thereof is only permitted with the express written permission of u-blox.

The information contained herein is provided "as is" and u-blox assumes no liability for its use. No warranty, either express or implied, is given, including but not limited to, with respect to the accuracy, correctness, reliability and fitness for a particular purpose of the information. This document may be revised by u-blox at any time without notice. For the most recent documents, visit [www.u-blox.com](http://www.u-blox.com).

Copyright © u-blox AG.

# Contents

<b>Document information</b> .....	<b>2</b>
<b>Contents</b> .....	<b>3</b>
<b>1 Functional description</b> .....	<b>5</b>
1.1 Features .....	5
1.2 Applications .....	5
1.3 Block diagram .....	6
1.4 Product specifications .....	6
<b>2 Pin definition</b> .....	<b>8</b>
2.1 Pin assignment.....	8
2.2 Peripheral pin assignments .....	9
<b>3 Electrical specifications</b> .....	<b>10</b>
3.1 Absolute maximum ratings .....	10
3.2 Operating conditions .....	10
3.3 General purpose I/O .....	10
3.4 Module reset .....	11
3.5 Debug and programming.....	11
3.6 Clocks .....	11
3.6.1 32.768 kHz crystal (LFXO).....	12
3.6.2 32.768 kHz clock source comparison .....	12
<b>4 Firmware</b> .....	<b>13</b>
4.1 Factory image .....	13
4.2 Bluetooth low energy SoftDevices.....	13
4.3 IEEE 802.15.4 (Thread and Zigbee) .....	13
4.4 Bluetooth device address .....	14
<b>5 Mechanical specifications</b> .....	<b>15</b>
5.1 Dimensions.....	15
5.2 Recommended PCB land pads .....	15
5.3 Module marking.....	16
5.3.1 BMD-360-A-R-00 module marking .....	16
5.3.2 BMD-360-A-R-10 and BMD-360-A-R-20 module markings .....	17
<b>6 RF design notes</b> .....	<b>18</b>
6.1 Recommended RF layout and ground plane.....	18
6.2 Mechanical enclosure.....	18
6.3 Antenna patterns.....	19
6.3.1 X-Y plane.....	19
6.3.2 X-Z plane.....	20
6.3.3 Y-Z plane.....	20
<b>7 BMD-360 evaluation development kit</b> .....	<b>21</b>
<b>8 Qualification and approvals</b> .....	<b>22</b>
8.1 United States (FCC) .....	22

8.1.1	Labeling and user information requirements .....	22
8.1.2	RF exposure .....	23
8.2	Canada (ISED) .....	23
8.2.1	Labeling and user information requirements .....	23
8.2.2	RF exposure .....	24
8.3	European Union regulatory compliance .....	24
8.3.1	Radio Equipment Directive (RED) 2014/53/EU .....	24
8.4	Australia / New Zealand (RCM) .....	24
8.5	Bluetooth qualification.....	24
<b>9</b>	<b>Environmental.....</b>	<b>25</b>
9.1	RoHS .....	25
9.2	REACH .....	25
9.3	California proposition 65 (P65) .....	25
<b>10</b>	<b>Product handling.....</b>	<b>26</b>
10.1	Packaging .....	26
10.1.1	BMD-360-A-R-00 reel packaging .....	26
10.1.2	BMD-360-A-R-10 and BMD-360-A-R-20 reel packaging .....	26
10.1.3	BMD-360-A-R-00 carrier tape dimensions.....	27
10.1.4	BMD-360-A-R-10 and BMD-360-A-R-20 carrier tape dimensions.....	27
10.2	Carrier tape orientation .....	28
10.3	Moisture sensitivity level.....	28
10.4	Reflow soldering .....	28
10.5	ESD precautions.....	28
<b>11</b>	<b>Ordering information.....</b>	<b>29</b>
<b>12</b>	<b>Life support and other high-risk warnings.....</b>	<b>30</b>
	<b>Related documents .....</b>	<b>31</b>
	<b>Revision history .....</b>	<b>31</b>
	<b>Contact.....</b>	<b>32</b>

# 1 Functional description

The BMD-360 is a powerful, highly flexible, ultra-low power Bluetooth 5.1 and IEEE 802.15.4 (Thread and Zigbee) module based on the nRF52811 SoC from Nordic Semiconductor. With an Arm® Cortex® M4 CPU, embedded 2.4GHz transceiver, and integrated antenna, it provides a complete RF solution with no additional RF design, allowing faster time to market. Providing full use of the nRF52811's capabilities and peripherals, the BMD-360 can power demanding applications, while simplifying designs and reducing BOM costs. Angle of Arrival (AoA) and Angle of Departure (AoD) features of Bluetooth 5.1 are supported. With an internal DC-DC converter and intelligent power control, the BMD-360 provides class-leading power efficiency, enabling ultra-low power sensitive applications. Regulatory pre-approvals reduce the burden to enter the market. As a drop-in replacement for the BMD-300/301/330, the BMD-360 completes the BMD-300 Series lineup with an optimized peripheral set that is attractive for a wide range of cost-sensitive applications.

## 1.1 Features

- Based on the Nordic Semiconductor nRF52811 SoC
- Bluetooth 5.1 2M PHY, 1M PHY, Coded PHY (long range), CSA #2, AoA, AoD
- IEEE 802.15.4 with Thread and Zigbee support
- Complete RF solution with an integrated DC-DC converter
- Nordic Semiconductor SoftDevice ready
- Over-the-Air (OTA) firmware updates
- No external components required
- Arm® Cortex®-M4 32-bit processor
- 192 kB embedded flash memory
- 24 kB RAM
- -40 °C to +85 °C Temperature Range
- 32 General Purpose I/O Pins
- 12-bit/200 KSPS ADC
- Serial Wire Debug (SWD)
- SPI Master/Slave (8 Mbps)
- 2-wire Master/Slave (I2C compatible)
- Footprint compatible with BMD-300, BMD-301, BMD-330, BMD-340, and BMD-341
- UART (w/ CTS/RTS and DMA)
- Temperature sensor
- 20 channel CPU independent Programmable Peripheral Interconnect (PPI)
- Quadrature Demodulator (QDEC)
- 128-bit AES HW encryption
- 3 x 32-bit Timer / Counter
- 2 x 24-bit Real-Time Counter (RTC)
- Dimensions: 14 x 9.8 x 1.9mm

## 1.2 Applications

- Beacons – iBeacon™, Eddystone, AltBeacon, AoA, AoD
- Low-Power Sensors
- Fitness devices
- Wearables
- Climate Control
- Lighting
- Safety and Security
- Home Appliances

- Access Control
- Internet of Things
- Home Health Care
- Advanced Remote Controls
- Smart Energy Management
- Low-Power Sensor Networks
- Interactive Entertainment
- Key Fobs
- Environmental Monitoring
- Hotel Automation
- Office Automation

### 1.3 Block diagram

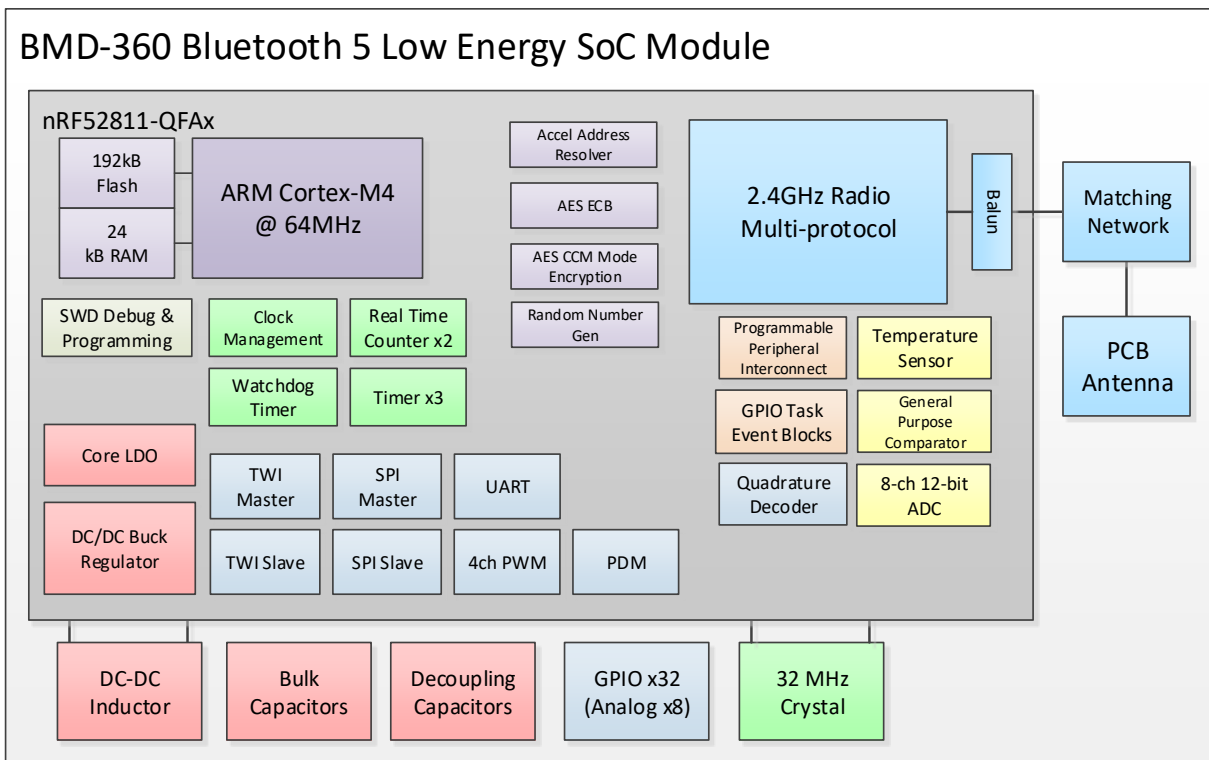

Figure 1: Block diagram of BMD-360

### 1.4 Product specifications

Detail	Description
<b>Bluetooth</b>	
Bluetooth version	Bluetooth 5.1 Low Energy, LE Coded PHY (Long Range), LE 2M PHY, LE 1M PHY, Advertising Extensions, CSA #2, AoA/AoD
Bluetooth security	AES-128
LE connections	Concurrent peripheral and broadcaster roles (S113)
<b>IEEE 802.15.4</b>	
Thread stack	OpenThread, Thread 1.1 compatible
Thread security	AES-128
Zigbee stack	Zigbee 3.0 compatible
<b>Radio</b>	
Frequency	2.360 GHz to 2.500 GHz

Detail	Description
Modulations	GFSK at 1 Mbps and 2 Mbps, QPSK at 250 Kbps
Transmit power	+4 dBm maximum
Receiver sensitivity	-97 dBm (Bluetooth low energy 1M mode), -104 dBm (Coded PHY mode)
Antenna	Integrated (-1 dBi peak)
<b>Current consumption</b>	
TX only @ +4 dBm, 0 dBm @ 3V, DCDC enabled	7.0 mA, 4.6 mA
TX only @ +4 dBm, 0 dBm	15.4 mA, 10.1 mA
RX only @ 1 Mbps @ 3V, DCDC enabled	4.6 mA
RX only @ 1 Mbps	10.0 mA
RX only @ 2 Mbps @ 3V, DCDC enabled	5.2 mA
RX only @ 2 Mbps	11.2 mA
CPU @ 64 MHz from flash, from RAM	4.2 mA, 4.0 mA
CPU @ 64 MHz from flash, from RAM @ 3 V, DCDC enabled	2.2 mA, 2.1 mA
System Off, On	0.3 $\mu$ A, 0.6 $\mu$ A
Additional current for RAM retention	30 nA / 4 KB block
<b>Dimensions</b>	
BMD-360	Length: 14.0 mm $\pm$ 0.3mm
	Width: 9.8 mm $\pm$ 0.3mm
	Height: 1.9 mm $\pm$ 0.1mm
<b>Hardware</b>	
Interfaces	SPI Master/Slave x 2 UART Two-Wire Master/Slave (I2C) GPIO x 32 PWM PDM
Power supply	1.7 V to 3.6 V
Temperature range	-40 $^{\circ}$ C to +85 $^{\circ}$ C
<b>Certifications</b>	
USA (FCC)	FCC part 15.247 modular certification FCC ID: XPYBMD360
Canada (ISED)	Innovation, Science and Economic Development Canada RSS-247 modular certification IC: 8595A-BMD360
Europe (CE)	EN 62368-1:2014+A11:2017 EN 62479:2010 EN 301 489-1 V2.1.1 EN 301 489-17 V3.2.0 EN 300 328 V2.2.2
Australia / New Zealand (RCM)	AS/NZS 4268:2017, Radio equipment and systems – Short range devices
Bluetooth	BMD-360 RF-PHY Component (Tested) – DID: D040773; QDID: 95452
<b>Radio chip</b>	
Nordic Semiconductor nRF52811	Additional details: nRF52811 Product Specification [3] nRF Connect SDK [4] nRF5 Software Development Kit [5]

**Table 1: Product specifications**

## 2 Pin definition

### 2.1 Pin assignment

BMD-360 shares an identical pin-out with BMD-300, BMD-301, and BMD-330. This pin-out is also a subset of the BMD-340/341 footprint, allowing a single design to support any of these modules.

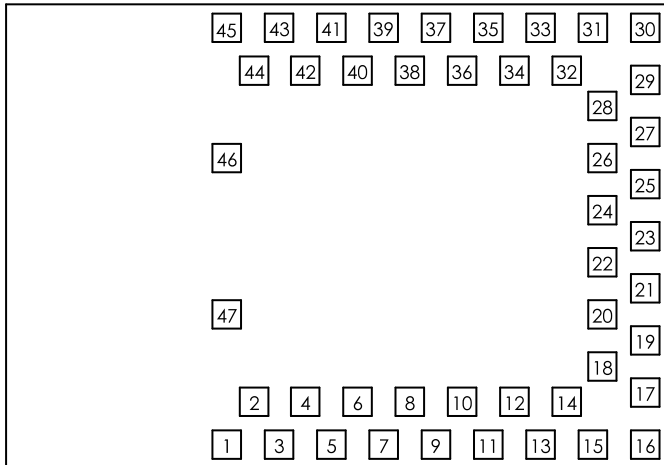

Figure 2: BMD-360 Pin assignment (Top view)

No.	Name	I/O	Description	nRF52 pin	Remarks
1	GND	Power	Electrical Ground		
2	GND	Power	Electrical Ground		
3	GND	Power	Electrical Ground		
4	GND	Power	Electrical Ground		
5	GND	Power	Electrical Ground		
6	P0.25	I/O	GPIO	P0.25	Standard drive, low frequency I/O only
7	P0.26	I/O	GPIO	P0.26	Standard drive, low frequency I/O only
8	P0.27	I/O	GPIO	P0.27	Standard drive, low frequency I/O only
9	P0.28	I/O	GPIO/AIN4	P0.28	Pin is analog capable, standard drive, low frequency GPIO only
10	P0.29	I/O	GPIO/AIN5	P0.29	Pin is analog capable, standard drive, low frequency GPIO only
11	P0.30	I/O	GPIO/AIN6	P0.30	Pin is analog capable
12	P0.31	I/O	GPIO/AIN7	P0.31	Pin is analog capable
13	P0.00	I/O	GPIO/XTAL1 (32.768 kHz)	P0.00	
14	P0.01	I/O	GPIO/XTAL2 (32.768 kHz)	P0.01	
15	P0.02	I/O	GPIO/AIN0	P0.02	Pin is analog capable
16	GND	Power	Electrical Ground		
17	VCC	Power	1.7 V to 3.6 V	VDD	An internal 4.7 $\mu$ F bulk capacitor is included on the module. However, it is good design practice to add additional bulk capacitance as required for your application, i.e. those with heavy GPIO usage and/or current draw.
18	GND	Power	Electrical Ground		
19	P0.03	I/O	GPIO/AIN1	P0.03	Pin is analog capable
20	P0.04	I/O	GPIO/AIN2	P0.04	Pin is analog capable
21	P0.05	I/O	GPIO/AIN3	P0.05	Pin is analog capable
22	P0.06	I/O	GPIO	P0.06	



No.	Name	I/O	Description	nRF52 pin	Remarks
23	P0.07	I/O	GPIO	P0.07	
24	P0.08	I/O	GPIO	P0.08	
25	P0.09	I/O	GPIO	P0.09	
26	P0.10	I/O	GPIO	P0.10	
27	P0.11	I/O	GPIO	P0.11	
28	P0.12	I/O	GPIO	P0.12	
29	GND	Power	Electrical Ground		
30	GND	Power	Electrical Ground		
31	P0.13	I/O	GPIO	P0.13	
32	P0.14	I/O	GPIO	P0.14	
33	P0.15	I/O	GPIO	P0.15	
34	P0.16	I/O	GPIO	P0.16	
35	P0.17	I/O	GPIO	P0.17	
36	P0.18	I/O	GPIO	P0.18	
37	P0.19	I/O	GPIO	P0.19	
38	P0.20	I/O	GPIO	P0.20	
39	P0.21	I/O	GPIO/RESET_N	P0.21	
40	P0.22	I/O	GPIO	P0.22	
41	P0.23	I/O	GPIO	P0.23	
42	P0.24	I/O	GPIO	P0.24	
43	SWCLK	I	SWD Clock	SWDCLK	
44	SWDIO	I/O	SWD IO	SWDIO	
45	GND	Power	Electrical Ground		
46	GND	Power	Electrical Ground		
47	GND	Power	Electrical Ground		

**Table 2: BMD-360 pin-out**

## 2.2 Peripheral pin assignments

The peripherals within the BMD-360 may be assigned to nearly any of the GPIO pins through the application. There are some restrictions called out by the nRF52811 product specification. See the Remarks in [Table 2](#). Also note that certain peripherals are assigned to specific pins, such the analog inputs.

 Only one peripheral signal can be multiplexed to a GPIO pin at a time. Trace signals, analog inputs, XTAL signals, SWD interface, and reset are restricted to certain pins due to additional internal circuitry required by the interface. See [Table 3](#).

Peripheral	Signal	Pin Options
UART0, I2C0, SPI0, SPI1, PDM, PWM0	All	P0.00-P0.31
ADC, COMP, LPCOMP	All	P0.02-P0.05, P0.28-P0.31 (AIN0-AIN7)
Reset	RESET_N	P0.21
SWD	SWD Clock	SWCLK
	SWD IO	SWDIO
32.768 kHz Crystal	XTAL1	P0.00
	XTAL2	P0.01

**Table 3: Peripheral pin options**

### 3 Electrical specifications

Stressing the device above one or more of the [Absolute maximum ratings](#) may cause permanent damage. These are stress ratings only. Operating the module at these or at any conditions other than those specified in the [Operating conditions](#) should be avoided. Exposure to absolute maximum rating conditions for extended periods can also affect device reliability.

Where application information is given, it is advisory only and does not form part of the specification.

#### 3.1 Absolute maximum ratings

Symbol	Description	Min	Max	Unit
V <sub>CC_MAX</sub>	Voltage on supply pin	-0.3	3.9	V
V <sub>IO_MAX</sub>	Voltage on GPIO pins (VCC > 3.6V)	-0.3	3.9	V
V <sub>IO_MAX</sub>	Voltage on GPIO pins (VCC ≤ 3.6V)	-0.3	VCC + V 0.3 V	
T <sub>S</sub>	Storage Temperature Range	-40	125	°C

**Table 4: Absolute maximum ratings**

The product is not protected against overvoltage or reversed voltages. If necessary, voltage spikes exceeding the power supply voltage specification, given in table above, must be limited to values within the specified boundaries by using appropriate protection devices.

#### 3.2 Operating conditions

Unless otherwise specified, all operating condition specifications are at an ambient temperature of 25 °C and a supply voltage of 3.3 V.

Operation beyond the specified operating conditions is not recommended and extended exposure beyond them may affect device reliability.

Symbol	Parameter	Min	Typ.	Max	Unit
V <sub>CC</sub>	Operating supply voltage	1.7	3.0	3.6	V
T <sub>R_VCC</sub>	Supply rise time (0 V to 1.7 V)	-	-	60	ms
T <sub>A</sub>	Operating Ambient Temperature Range	-40	25	85	°C

**Table 5: Operating conditions**

#### 3.3 General purpose I/O

The general purpose I/O is organized as one port enabling access and control of the 32 available GPIO pins via one port. Each GPIO can be accessed with the following user configurable features:

- Input/output direction
- Output drive strength
- Internal pull-up and pull-down resistors
- Wake-up from high- or low-level triggers on all pins
- Trigger interrupt on all pins

- All pins can be used by the PPI task/event system; the maximum number of pins that can be interfaced through the PPI at the same time is limited by the number of GPIOTE channels
- All pins can be individually configured to carry serial interface or quadrature demodulator signals

Symbol	Parameter	Min.	Typ.	Max.	Unit
$V_{IH}$	Input High Voltage	$0.7 \times VCC$	-	VCC	V
$V_{IL}$	Input Low Voltage	GND	-	$0.3 \times VCC$	V
$V_{OH}$	Output High Voltage	$VCC - 0.4$	-	VCC	V
$V_{OL}$	Output Low Voltage	GND	-	$GND + 0.4$	V
$R_{PU}$	Pull-up Resistance	11	13	16	k $\Omega$
$R_{PD}$	Pull-down Resistance	11	13	16	k $\Omega$

Table 6: GPIO electrical specifications

### 3.4 Module reset

GPIO pin P0.21 may be used for a hardware reset. In order to utilize P0.21 as a hardware reset, the UICR registers PSELRESET[0] and PSELRESET[1] must be set alike, to the value of 0x7FFFFFFF15. When P0.21 is programmed as RESET, the internal pull-up is automatically enabled. Nordic Semiconductor example applications and development kits program P0.21 as RESET.

### 3.5 Debug and programming

The BMD-360 series supports the two pin Serial Wire Debug (SWD) interface and offers flexible and powerful mechanism for non-intrusive debugging of program code. Breakpoints, single stepping, and instruction trace capture of code execution flow are supported.

### 3.6 Clocks

The BMD-360 requires two clocks, a high frequency clock and a low frequency clock.

The high frequency clock is provided on-module by a high-accuracy 32 MHz crystal as required by the nRF52811 for radio operation.

The low frequency clock can be provided internally by an RC oscillator or synthesized from the fast clock, or externally by a 32.768 kHz crystal. An external crystal provides the lowest power consumption and greatest accuracy. Using the internal RC oscillator with calibration provides acceptable performance for Bluetooth low energy applications at a reduced cost and slight increase in power consumption.

### 3.6.1 32.768 kHz crystal (LFXO)

Symbol	Parameter	Typ.	Max.	Unit
$F_{NOM\_LFXO}$	Crystal frequency	32.768	-	kHz
$F_{TOL\_LFXO\_BLE}$	Frequency tolerance, Bluetooth low energy applications <sup>1</sup>	-	±250	ppm
$F_{TOL\_LFXO\_ANT}$	Frequency tolerance, ANT applications <sup>1</sup>	-	±50	ppm
$C_{L\_LFXO}$	Load Capacitance	-	12.5	pF
$C_{O\_LFXO}$	Shunt Capacitance	-	2	pF
$R_{S\_LFXO}$	Equivalent series resistance	-	100	kΩ
$C_{pin}$	Input Capacitance on XL1 & XL2 pads	4	-	pF

**Table 7: 32.768 kHz crystal (LFXO)**

### 3.6.2 32.768 kHz clock source comparison

Symbol	Parameter	Min.	Typ.	Max.	Unit
$I_{ON\_RAM\_OFF\_RTC\_LFXO}$	System ON with 32.768 kHz Crystal Oscillator	-	1.0	-	μA
$I_{ON\_RAM\_OFF\_RTC}$	Current for 32.768 kHz RC Oscillator	-	1.4	-	μA
$f_{TOL\_LFRC}$	Frequency Tolerance, 32.768 kHz RC Oscillator	-	-	±5	%
$f_{TOL\_CAL\_LFRC}$	Frequency tolerance, 32.768 kHz RC after calibration	-	-	±500	ppm
$f_{TOL\_LFSYNT}$	Frequency Tolerance, 32.768 kHz Synthesized Oscillator	-	-	±48	ppm

**Table 8: 32.768 kHz clock source comparison**

<sup>1</sup>  $f_{TOL\_LFXO\_BLE}$  and  $f_{TOL\_LFXO\_ANT}$  are the maximum allowed for Bluetooth low energy applications. Actual tolerance depends on the crystal used.

## 4 Firmware

Projects for the BMD-360 should utilize the Nordic Semiconductor nRF Connect SDK [\[4\]](#) and the nRF52811 tools for new development. The tools allow access to the very latest Bluetooth support from Nordic Semiconductor and provide an ongoing path as new features are released.

The nRF5 SDK [\[5\]](#) can also be used if the feature set of the SDK meets the application requirements.

### 4.1 Factory image

The BMD-360 module is not loaded with a factory firmware image.

### 4.2 Bluetooth low energy SoftDevices

Nordic Semiconductor protocol stacks for Bluetooth low energy are known as SoftDevices. SoftDevices are pre-compiled, pre-linked binary files. SoftDevices can be programmed in nRF52 series SoCs and are downloadable from the Nordic Semiconductor website.

The S113 SoftDevice is a Bluetooth low energy peripheral protocol stack solution. It supports up to four peripheral connections with an additional broadcaster role running concurrently. The S113 SoftDevice integrates a Bluetooth low energy Controller and Host and provides a full and flexible API for building Bluetooth low energy nRF52 System on Chip (SoC) solutions.

### 4.3 IEEE 802.15.4 (Thread and Zigbee)

IEEE 802.15.4 based protocols on BMD-360, such as Thread and Zigbee, are not implemented using a SoftDevice. Nordic Semiconductor provide pre-compiled Thread and Zigbee stacks and an IEEE 802.15.4 compliant MAC stack, which does not require a SoftDevice to be loaded to operate. Both allow for concurrent operation with Bluetooth low energy SoftDevices.

For more information about developing applications that utilize IEEE 802.15, see also reference [\[4\]](#).

## 4.4 Bluetooth device address

The BMD-360 modules are preprogrammed from the factory with a unique public Bluetooth device (MAC) address stored in the CUSTOMER[0] and CUSTOMER[1] registers of the User Information Configuration Registers (UICR). The Bluetooth device address consists of the IEEE Organizationally Unique Identifier (OUI) combined with the six hexadecimal digits that are printed on a 2D barcode and in human-readable text on the module label, as described in [Module marking](#). The Bluetooth device address is stored in little endian format. The most significant bytes of the CUSTOMER[1] register are 0xFF to complete the 32-bit register.

UICR Register	Address	Description	Remarks
CUSTOMER[0]	0x10001080	Bluetooth_addr [0] (0xFF)	Example value. Actual value printed on label
CUSTOMER[0]	0x10001081	Bluetooth_addr [1] (0xEE)	Example value. Actual value printed on label
CUSTOMER[0]	0x10001082	Bluetooth_addr [2] (0xDD)	Example value. Actual value printed on label
CUSTOMER[0]	0x10001083	Bluetooth_addr [3] (0xCC)	IEEE OUI <sup>2,3</sup>
CUSTOMER[1]	0x10001084	Bluetooth_addr [4] (0xBB)	IEEE OUI <sup>2,3</sup>
CUSTOMER[1]	0x10001085	Bluetooth_addr [5] (0xAA)	IEEE OUI <sup>2,3</sup>
CUSTOMER[1]	0x10001086	0xFF	Unused
CUSTOMER[1]	0x10001087	0xFF	Unused

**Table 9: Bluetooth device address**

<sup>2</sup> The IEEE OUI for type number BMD-360-A-R-00 is: 94:54:93. The second half of the full Bluetooth device address is encoded in the label data matrix. The full Bluetooth device address is stored in the UICR.

<sup>3</sup> Type numbers BMD-360-A-R-10 and BMD-360-A-R-20 encode the full Bluetooth device address in the label data matrix and is stored in the UICR.

# 5 Mechanical specifications

## 5.1 Dimensions

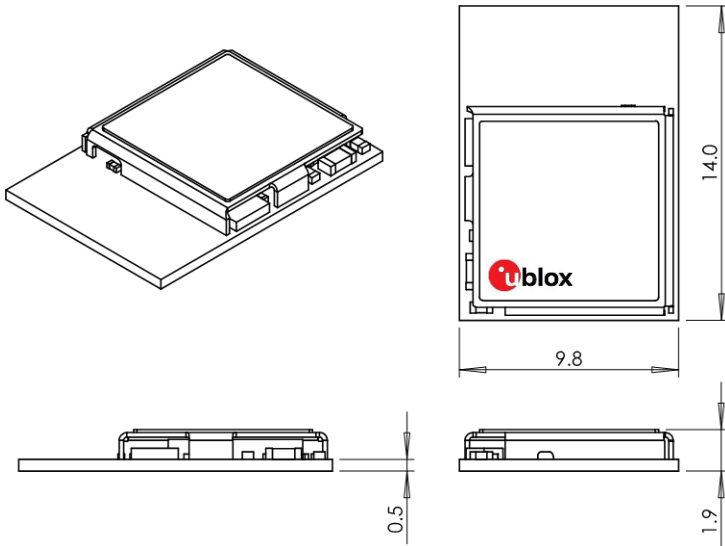

Length:  $\pm 0.3$  mm, Width:  $\pm 0.3$  mm, Height:  $\pm 0.1$  mm

Figure 3: BMD-360 mechanical drawing

## 5.2 Recommended PCB land pads

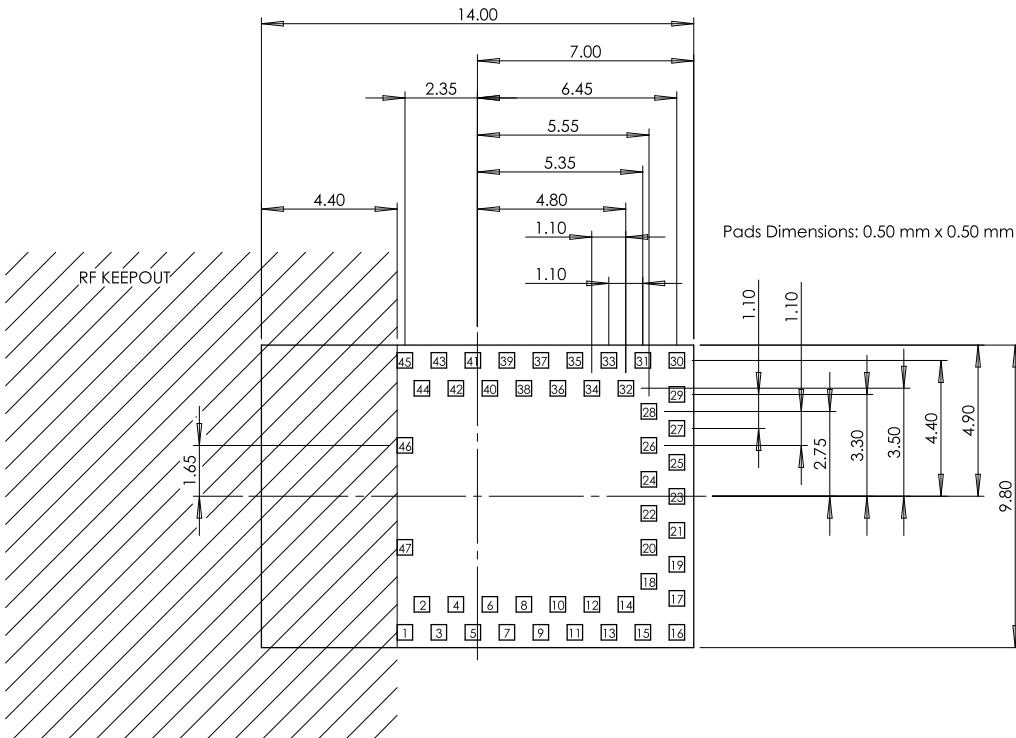

Figure 4: Recommended PCB land pads

The RF Keep-out area extends vertically to the board edge.

## 5.3 Module marking

### 5.3.1 BMD-360-A-R-00 module marking

Figure 5 illustrates the label of the BMD-360 modules, which includes the u-blox logo, product name, Bluetooth address, and certification numbers.

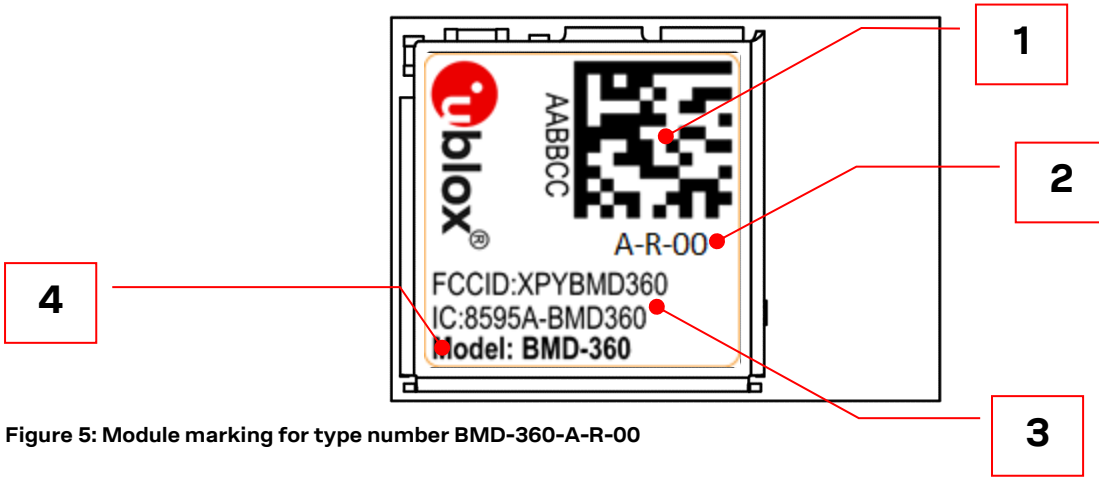

Figure 5: Module marking for type number BMD-360-A-R-00

Reference	Description
1	Data Matrix with unique serial number of six alphanumeric symbols, also in human-readable form. The full Bluetooth address consists of the IEEE OUI (94:54:93) with the six symbols appended: Example value: 94:54:93:AA:BB:CC
2	Last characters of type number: BMD-360-A-R-00
3	FCC and ISED (IC) Certification IDs
4	Product name

Table 10: BMD-360 label description for type number BMD-360-A-R-00



### 5.3.2 BMD-360-A-R-10 and BMD-360-A-R-20 module markings

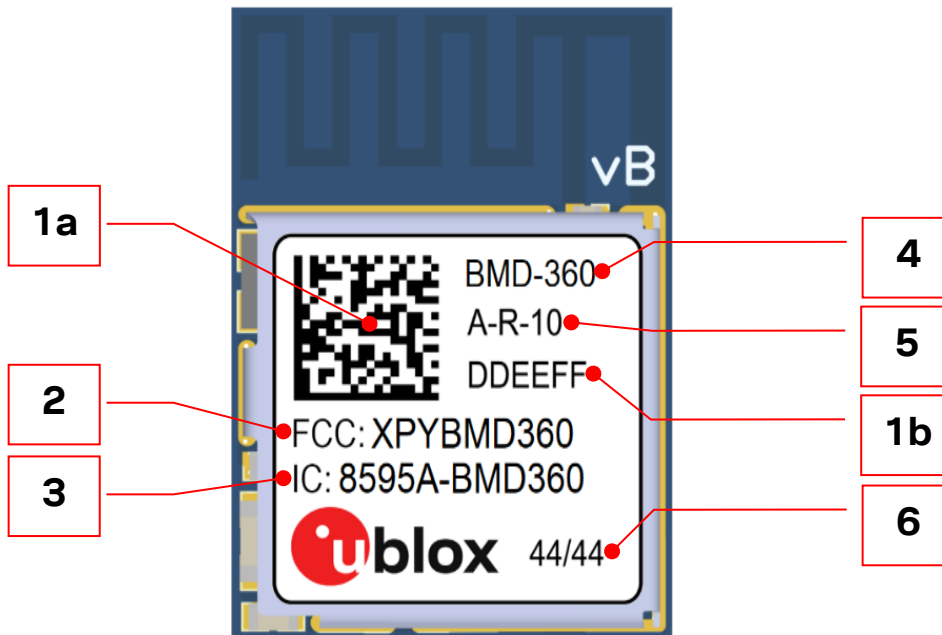

Figure 6: Module marking for type number BMD-360-A-R-10 and BMD-360-A-R-20

Reference	Description
1a	Data Matrix with unique serial number of 19 alphanumeric symbols. The first 3 symbols represent module type number unique to each module variant, the next 12 symbols represent the unique hexadecimal Bluetooth device address of the module AABCCDDEEFF, and the last 4 symbols represent the hardware and firmware version encoded HFFF.
1b	Second half of Bluetooth device address in human-readable format (DDEEFF above)
2	FCC ID (USA)
3	ISED (IC) ID (Canada)
4	Product name (Model)
4+5	Product type number
6	Date of production encoded YY/WW (year / week)

Table 11: Module marking for type number BMD-360-A-R-10 and BMD-360-A-R-20

Type number BMD-360-A-R-20 has an additional data matrix and marking located on the bottom side of the PCB. This data is for factory use only. Figure 7 shows type number BMD-360-A-R-10 (left) and BMD-360-A-R-20 (right).

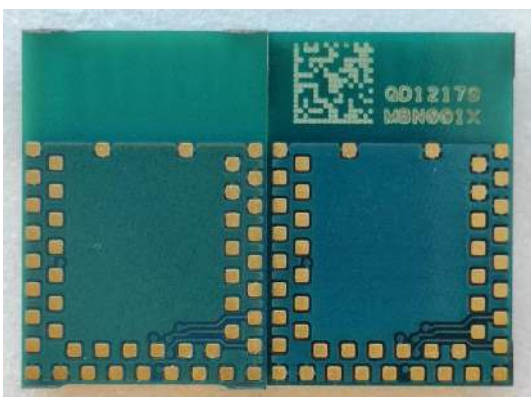

Figure 7: BMD-360-A-R-20 data matrix and marking example on PCB bottom side

## 6 RF design notes

### 6.1 Recommended RF layout and ground plane

The integrated antenna in BMD-360 requires a suitable ground plane to radiate effectively.

The area under and extending out from the antenna portion of the module should be kept clear of copper and other metal. The module should be placed at the edge of the PCB with the antenna edge facing out. Reducing the ground plane from that shown in [Figure 8](#) reduces the effective radiated power. For example, a 27 mm x 29 mm board (about the size of a coin cell) transmits a radiated power that is approximately 3 dB less than that transmitted by the BMD-360 Evaluation Board.

These RF guidelines are equally applicable to the BMD-300 module as they are for BMD-360. Designs incorporating the BMD-300 have a similar RF performance as the BMD-360 module.

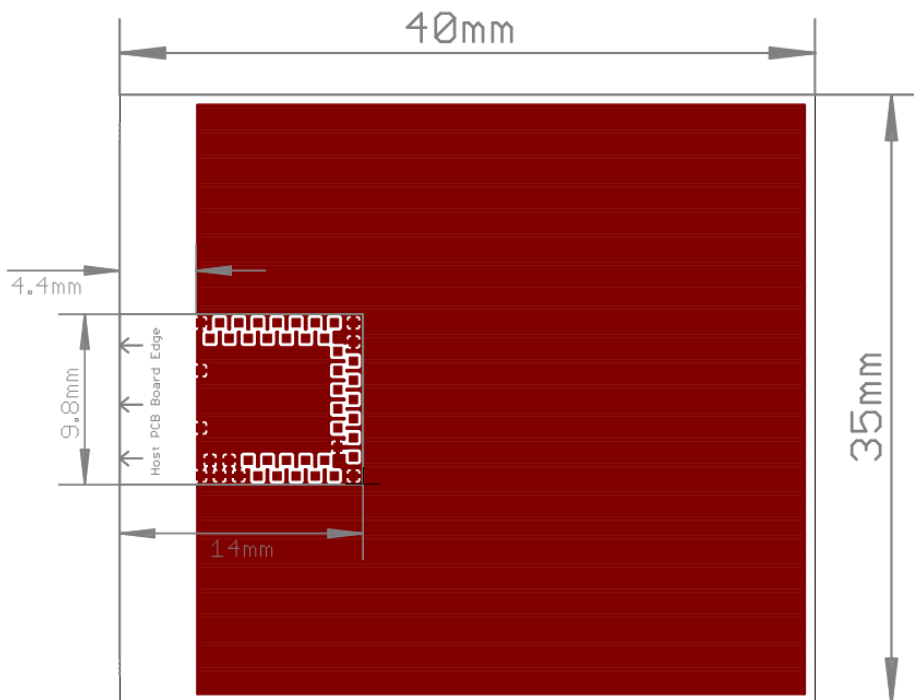

Figure 8: Recommended RF layout and ground plane for BMD-360

### 6.2 Mechanical enclosure

Care should be taken when designing and placing the BMD-360 module into an enclosure. Metal should be kept clear from the antenna area, both above and below. Any metal around the module can negatively impact RF performance.

The module is designed and tuned for the antenna and RF components to be in free air. Any potting, epoxy fill, plastic over-molding, or conformal coating can negatively impact RF performance and must be evaluated by the customer.

### 6.3 Antenna patterns

Antenna patterns are based on the BMD-360-EVAL with a ground plane size of 82 mm x 56 mm. The X-Y-Z orientation is shown in Figure 9.

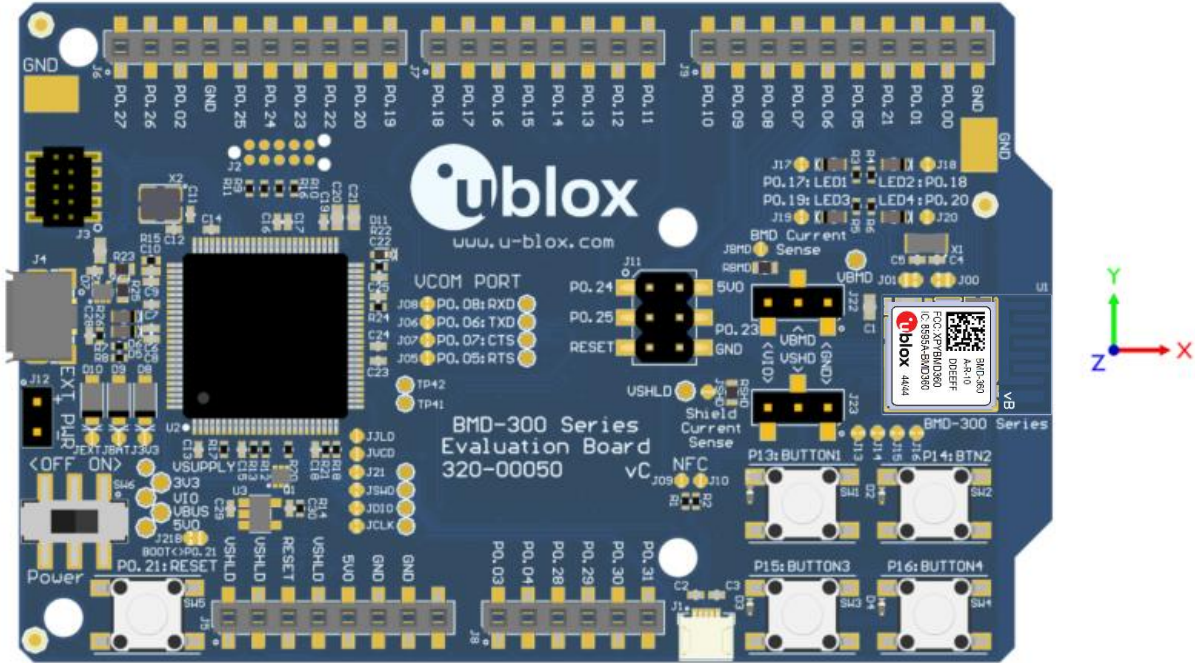

Figure 9: BMD-360 Evaluation kit X-Y-Z orientation

#### 6.3.1 X-Y plane

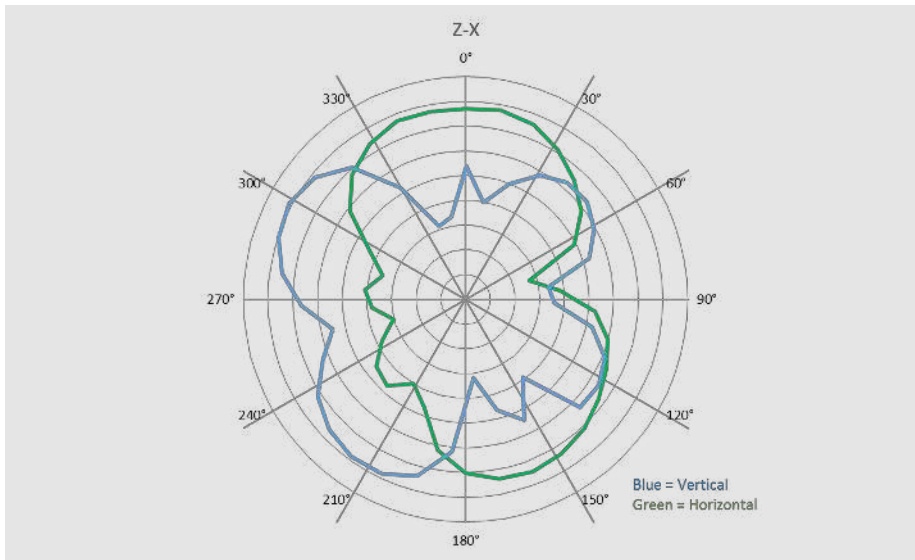

Figure 10: X-Y Plane Antenna Pattern

The outer-most ring is +5 dB. Each division is -5 dB.

### 6.3.2 X-Z plane

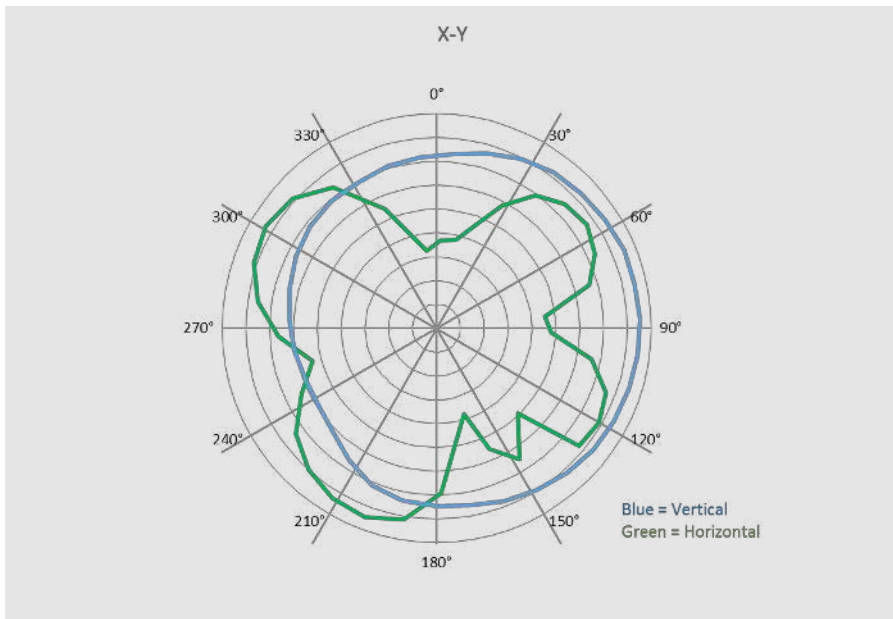

Figure 11: X-Z Plane Antenna Pattern

The outer-most ring is +5 dB. Each division is -5 dB.

### 6.3.3 Y-Z plane

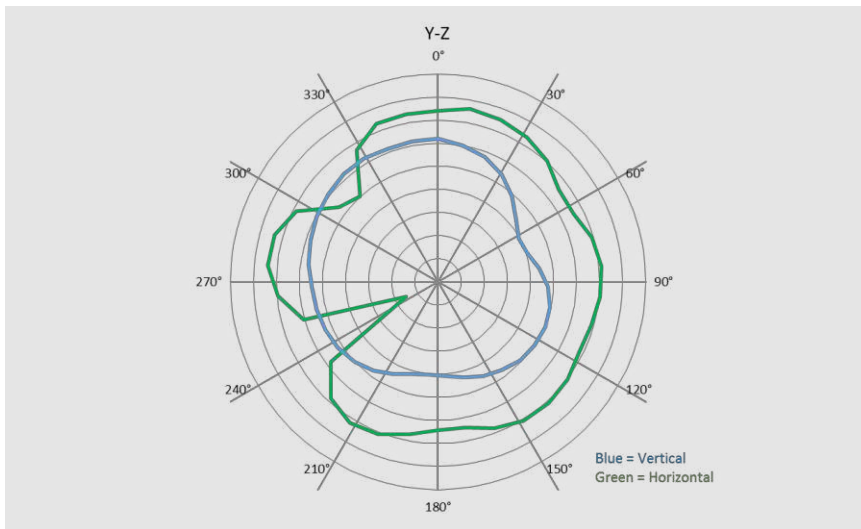

Figure 12: Y-Z Plane Antenna Pattern

The outer-most ring is +5 dB. Each division is -5 dB.

## 7 BMD-360 evaluation development kit

BMD-360-EVAL is a full-featured evaluation board that supports a power and virtual COM port over USB, 32.768 kHz crystal, on-board programming and debugging, four user LEDs, four user buttons, and a complete I/O pinout to headers.



BMD-360-EVAL also supports a power option that allows the board to be powered from a CR2032 coin cell battery, with current sense resistors and headers that provide good access for current measurements. An Arduino Uno R3 style header is provided for easy prototyping of any additional functions. BMD-360-EVAL also supports off-board programming for ANNA-B1, NINA-B1/B3/B4, and BMD-3 series modules.

## 8 Qualification and approvals

### 8.1 United States (FCC)

The BMD-360 module has received Federal Communications Commission (FCC) CFR47 Telecommunications, Part 15 Subpart C “Intentional Radiators” modular approval in accordance with Parts 15.212 and 15.247. The modular approval allows the end user to integrate the module into a finished product without obtaining subsequent and separate FCC approvals for intentional radiation, provided no changes or modifications are made to the module circuitry. Changes or modifications could void the user’s authority to operate the equipment. The end user must comply with all of the instructions provided by the Grantee, which indicate installation and/or operating conditions necessary for compliance.

The finished product is required to comply with all applicable FCC equipment authorizations regulations, requirements and equipment functions not associated with the transmitter module portion. For example, compliance must be demonstrated to regulations for other transmitter components within the host product; to requirements for unintentional radiators (Part 15 Subpart B “Unintentional Radiators”), such as digital devices, computer peripherals, radio receivers, etc.; and to additional authorization requirements for the non-transmitter functions on the transmitter module (that is, Verification, or Declaration of Conformity) (for example, transmitter modules may also contain digital logic functions) as appropriate.

-  Modification to this product will void the users’ authority to operate this equipment.
-  The OEM is still responsible for verifying end product compliance with FCC Part 15, subpart B limits for unintentional radiators through an accredited test facility.

#### 8.1.1 Labeling and user information requirements

**The BMD-360 is assigned the FCC ID number: XPYBMD360**

If the FCC ID is not visible when the module is installed inside another device, then the outside of the finished product into which the module is installed must also display a label referring to the enclosed module. This exterior label can use the following or similar wording:

Contains FCC ID: XPYBMD360

In addition to marking the product with the appropriate FCC ID, the end product shall bear the following statement in a conspicuous location on the device ([FCC Rules, Title 47, Subchapter A, Part 15, Subpart B, Chapter §15.19](#)):

This device complies with part 15 of the FCC Rules. Operation is subject to the following two conditions: (1) This device may not cause harmful interference, and (2) this device must accept any interference received, including interference that may cause undesired operation.

When the device is so small or for such use that it is impracticable to label it with the statement specified above in a font that is four-point or larger, and the device does not have a display that can show electronic labeling, then the information required by this paragraph shall be placed in the user manual and must also either be placed on the device packaging or on a removable label attached to the device.

The user manual may also require specific information based on the digital device classification. Refer to the [FCC Rules, Title 47, Subchapter A, Part 15, Subpart B, Chapter §15.105](#) for specific wording of these notices.

## 8.1.2 RF exposure

All transmitters regulated by FCC must comply with RF exposure requirements. [KDB 447498 General RF Exposure Guidance](#) provides guidance in determining whether proposed or existing transmitting facilities, operations or devices comply with limits for human exposure to Radio Frequency (RF) fields adopted by the Federal Communications Commission (FCC).

This module is approved for installation into mobile and/or portable host platforms and must not be co-located or operating in conjunction with any other antenna or transmitter except in accordance with FCC multi-transmitter guidelines. End users must be provided with transmitter operating conditions for satisfying RF Exposure compliance.

## 8.2 Canada (ISED)

The BMD-360 module is certified for use in Canada under Innovation, Science and Economic Development Canada (ISED) Radio Standards Specification (RSS) RSS-247 Issue 2 and RSSGen.

### 8.2.1 Labeling and user information requirements

**The BMD-360 is assigned the IC ID number: 8595A-BMD360**

Labeling Requirements for the Host Device (from Section 3.2.1, RSS-Gen, Issue 3, December 2010): The host device shall be properly labeled to identify the module within the host device. The Industry Canada certification label of a module shall be clearly visible at all times when installed in the host device, otherwise the host device must be labeled to display the Industry Canada certification number of the module, preceded by the words “Contains transmitter module”, or the word “Contains”, or similar wording expressing the same meaning, as follows:

Contains transmitter module IC: 8595A-BMD360

User Manual Notice for License-Exempt Radio Apparatus (from Section 7.1.3 RSS-Gen, Issue 3, December 2010): User manuals for license-exempt radio apparatus shall contain the following or equivalent notice in a conspicuous location in the user manual or alternatively on the device or both:

This device complies with Industry Canada license exempt RSS standard(s). Operation is subject to the following two conditions: (1) this device may not cause interference, and (2) this device must accept any interference, including interference that may cause undesired operation of the device.

Le présent appareil est conforme aux CNR d'Industrie Canada applicables aux appareils radio exempts de licence. L'exploitation est autorisée aux deux conditions suivantes: (1) l'appareil ne doit pas produire de brouillage, et (2) l'utilisateur de l'appareil doit accepter tout brouillage radioélectrique subi, même si le brouillage est susceptible d'en compromettre le fonctionnement.

Transmitter Antenna (from Section 7.1.2 RSS-Gen, Issue 3, December 2010): User manuals for transmitters shall display the following notice in a conspicuous location:

Under Industry Canada regulations, this radio transmitter may only operate using an antenna of a type and maximum (or lesser) gain approved for the transmitter by Industry Canada. To reduce potential radio interference to other users, the antenna type and its gain should be so chosen that the equivalent isotropically radiated power (e.i.r.p.) is not more than that necessary for successful communication.

Conformément à la réglementation d'Industrie Canada, le présent émetteur radio peut fonctionner avec une antenne d'un type et d'un gain maximal (ou inférieur) approuvé pour l'émetteur par Industrie Canada. Dans le but de réduire les risques de brouillage radioélectrique à l'intention des autres utilisateurs, il faut choisir le type d'antenne et son gain de sorte que la puissance isotrope rayonnée équivalente (p.i.r.e.) ne dépasse pas l'intensité nécessaire à l'établissement d'une communication satisfaisante.

## 8.2.2 RF exposure

All transmitters regulated by IC must comply with RF exposure requirements listed in RSS-102 - Radio Frequency (RF) Exposure Compliance of Radiocommunication Apparatus (All Frequency Bands). This module is approved for installation into mobile and/or portable host platforms and must not be co-located or operating in conjunction with any other antenna or transmitter except in accordance with Industry Canada's multi-transmitter guidelines. End users must be provided with transmitter operating conditions for satisfying RF Exposure compliance.

## 8.3 European Union regulatory compliance

Information about regulatory compliance of the European Union for the BMD-360 module is available in the BMD-360 Declaration of Conformity [2].

### 8.3.1 Radio Equipment Directive (RED) 2014/53/EU

The BMD-360 module complies with the essential requirements and other relevant provisions of Radio Equipment Directive (RED) 2014/53/EU.

## 8.4 Australia / New Zealand (RCM)

BMD-360 has been tested to comply with the AS/NZS 4268:2017, Radio equipment and systems – Short range devices – Limits and methods of measurement. The report may be obtained from your local FAE and may be used as evidence in obtaining permission to use the Regulatory Compliance Mark (RCM).

Information on registration as a Responsible Party, license and labeling requirements may be found at the following websites:

Australia: <http://www.acma.gov.au/theACMA/radiocommunications-short-range-devices-standard-2004>

New Zealand: <http://www.rsm.govt.nz/compliance>

Only Australian-based and New Zealand-based companies who are registered may be granted permission to use the RCM. An Australian-based or New Zealand-based agent or importer may also register as a Responsible Party to use the RCM on behalf of a company not in Australia or New Zealand.

## 8.5 Bluetooth qualification

The Bluetooth SIG maintains the Bluetooth Specification, and ensures that products are properly tested and comply with the Bluetooth license agreements. Companies that list products with the Bluetooth SIG are required to be members of the SIG and submit the listed fees. Refer to this link for details: <https://www.bluetooth.com/develop-with-bluetooth/qualification-listing>

The BMD-360 Bluetooth Low Energy module based on the Nordic Semiconductor nRF52811 is listed as a “Tested Component”, with Qualified Design ID 95452. This allows an end-product based on a BMD-360 module to inherit the component listings without the need to run through all of the tests again. The end-product will often inherit several QDIDs that are subsequently identified in a “Declaration of Compliance”.

BMD-360 primarily utilizes the S113 SoftDevice.



## 9 Environmental

### 9.1 RoHS

BMD-360 modules comply with Directive 2011/65/EU, 2015/863/EU of the European Parliament and the Council, with regards to the restricted use of certain hazardous substances in electrical and electronic equipment. The RoHS declaration is included in the BMD-360 Declaration of Conformity [2].

### 9.2 REACH

BMD-360 modules do not contain the [SVHC \(Substance of Very High Concern\)](#), as defined by Directive EC/1907/2006 Article according to REACH Annex XVII.

### 9.3 California proposition 65 (P65)

This product can expose you to Nickel (metallic), which is known to the State of California to cause cancer. For more information go to [www.P65Warnings.ca.gov](http://www.P65Warnings.ca.gov).



Warnings are not required where the listed chemical is inaccessible to the average user of the end product.

# 10 Product handling

## 10.1 Packaging

### 10.1.1 BMD-360-A-R-00 reel packaging

Modules are packaged on 330 mm reels loaded with 1000 modules. Each reel is placed in an antistatic bag, with a desiccant pack and humidity card, and packaged in a 340x350x65 mm box. An antistatic warning and reel label are affixed to the outside of the bag.

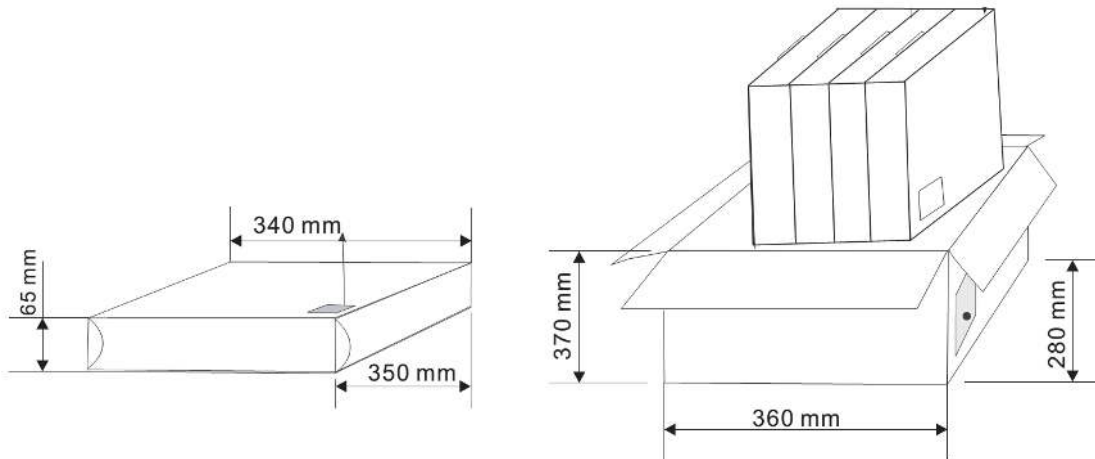

Figure 13: Reel cartons used for type number BMD-360-A-R-00

### 10.1.2 BMD-360-A-R-10 and BMD-360-A-R-20 reel packaging

Modules are packaged on 330 mm reels loaded with 1000 modules. Each reel is placed in an antistatic bag, with a desiccant pack and humidity card, and packaged in a 370x355x56 mm box. For the full packaging specifications, including the reel dimensions, shipping label content and box sizes, see also the Packaging Information reference [1]. BMD-360-A-R-10 and BMD-360-A-R-20 modules are packaged on u-blox reel type A3.

### 10.1.3 BMD-360-A-R-00 carrier tape dimensions

The BMD-360-A-R-00 modules are placed in the carrier tape specified in Figure 14. The module antenna is facing the tape sprocket holes.

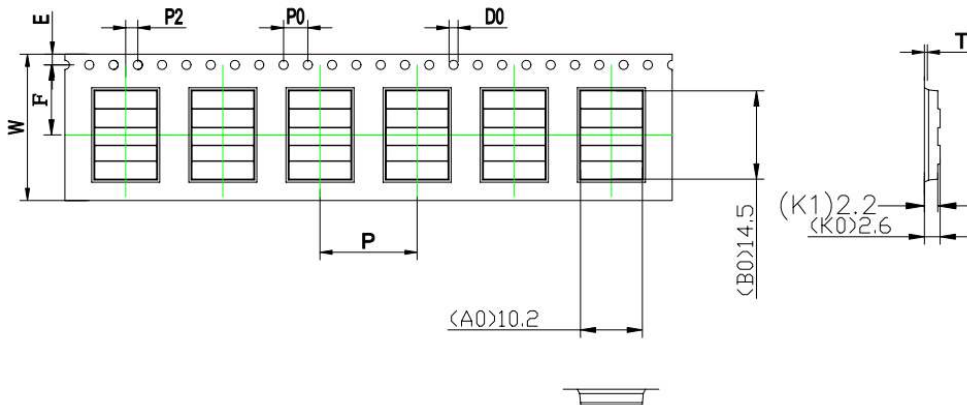

ITEM	W	A <sub>0</sub>	B <sub>0</sub>	K <sub>0</sub>	K <sub>1</sub>	P	F	E	D <sub>0</sub>	D <sub>1</sub>	P <sub>0</sub>	P <sub>2</sub>	T
DIM	24.0 <sup>+0.30</sup> <sub>-0.30</sub>	10.2 <sup>+0.10</sup> <sub>-0.10</sub>	14.5 <sup>+0.10</sup> <sub>-0.10</sub>	2.6 <sup>+0.10</sup> <sub>-0.10</sub>	2.2 <sup>+0.00</sup> <sub>-0.00</sub>	16.0 <sup>+0.10</sup> <sub>-0.10</sub>	11.5 <sup>+0.10</sup> <sub>-0.10</sub>	1.75 <sup>+0.10</sup> <sub>-0.10</sub>	1.50 <sup>+0.10</sup> <sub>-0.00</sub>	0.00 <sup>+0.10</sup> <sub>-0.00</sub>	4.00 <sup>+0.10</sup> <sub>-0.10</sub>	2.00 <sup>+0.10</sup> <sub>-0.10</sub>	0.30 <sup>+0.05</sup> <sub>-0.05</sub>
ALTERNATE													

Figure 14: BMD-360-A-R-00 carrier tape dimensions

### 10.1.4 BMD-360-A-R-10 and BMD-360-A-R-20 carrier tape dimensions

The dimensions of the carrier tape on which BMD-360-A-R-10 and BMD-360-A-R-20 are packaged are shown in Figure 15. The module antenna is facing the sprocket holes in the tape.

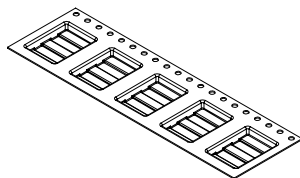
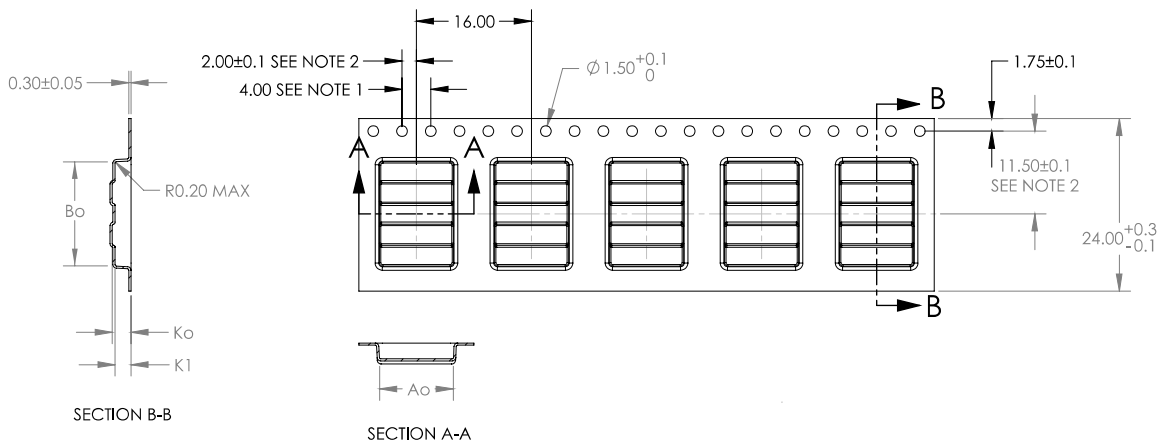

	DIM	±
A <sub>0</sub>	10.30	0.1
B <sub>0</sub>	14.50	0.1
K <sub>0</sub>	2.60	0.1
K <sub>1</sub>	2.20	0.1

NOTES:

1. 10 SPROCKET HOLE PITCH CUMULATIVE TOLERANCE ±0.2
2. POCKET POSITION RELATIVE TO SPROCKET HOLE MEASURED AS TRUE POSITION OF POCKET, NOT POCKET HOLE.
3. A<sub>0</sub> AND B<sub>0</sub> ARE MEASURED ON A PLANE AT A DISTANCE "R" ABOVE THE BOTTOM OF THE POCKET.

Figure 15: BMD-360-A-R-10 and BMD-360-A-R-20 carrier tape dimensions

## 10.2 Carrier tape orientation

BMD-360 modules are positioned in the carrier tape with the red u-blox logo dot on the label in **quadrant 3**. See [Figure 16](#).

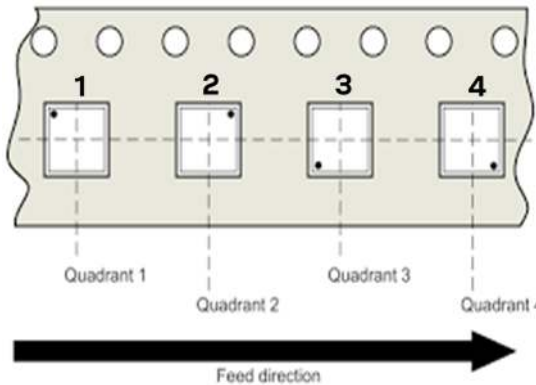

Figure 16: Carrier tape quadrants

“Feed direction” is defined in such a way that at the customer’s assembly line, at first the module at position “4” will be picked, then “3”, “2” and “1”.

## 10.3 Moisture sensitivity level

BMD-360 is rated for MSL 3 with a 168-hour floor life after opening.

## 10.4 Reflow soldering

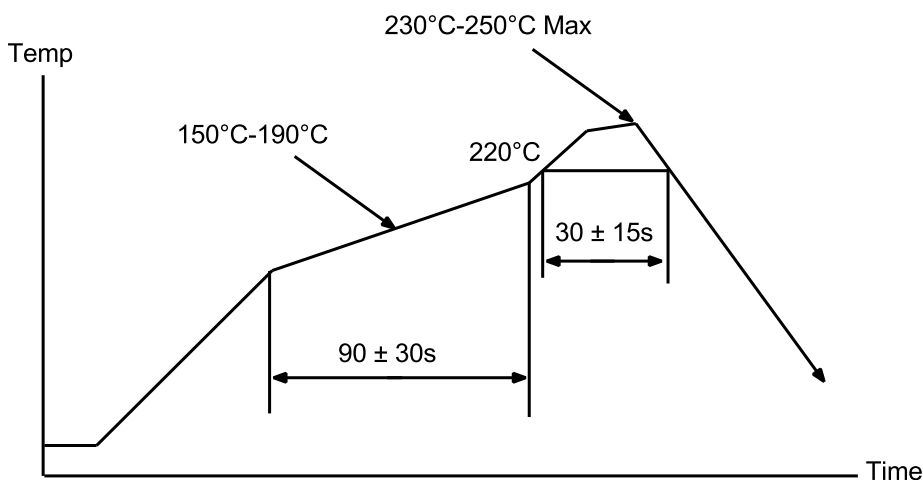

Figure 17: Reflow profile for lead free solder

## 10.5 ESD precautions

⚠ The BMD-360 module contains highly sensitive electronic circuitry and is an Electrostatic Sensitive Device (ESD). Handling the BMD-360 module without proper ESD protection may destroy or damage them permanently.

Proper ESD handling and packaging procedures must be applied throughout the processing, handling and operation of any application that incorporates the BMD-360 module. Failure to observe these recommendations can result in severe damage to the device.

# 11 Ordering information

Ordering Code	Product
BMD-360-A-R	BMD-360 module, Rev A, Tape & Reel, 1000-piece multiples
BMD-360-EVAL	BMD-360 Evaluation Kit w/ SEGGER J-Link-OB debug probe

**Table 12: Product ordering codes**

## 12 Life support and other high-risk warnings

This product is not designed nor intended for use in a life support device or system, nor for use in other fault-intolerant, hazardous or other environments requiring fail-safe performance, such as any application in which the failure or malfunction of the product could lead directly or indirectly to death, bodily injury, or physical or property damage (collectively, “High-Risk Environments”).

 u-blox expressly disclaims any express or implied warranty of fitness for use in high-risk environments.

The customer using this product in a High-Risk Environment agrees to indemnify and defend u-blox from and against any claims and damages arising out of such use.

## Related documents

- [1] Packaging information reference, [UBX-14001652](#)
- [2] BMD-360 EU Declaration of Conformity, [UBX-19057306](#)
- [3] Nordic Semiconductor, [nRF52811 Product Specification](#)
- [4] Nordic Semiconductor, [nRF Connect SDK](#)
- [5] Nordic Semiconductor, [nRF5 Software Development Kit](#)

 For product change notifications and regular updates of u-blox documentation, register on our website, [www.u-blox.com](http://www.u-blox.com).

## Revision history

Revision	Date	Name	Comments
0.5	15-Apr-2019		Preliminary release for engineering.
0.6	01-Jul-2019		Corrected typos. Updated Nordic Semiconductor documentation link. Updated images.
R03	21-Oct-2019		Document converted from Rigado to u-blox BMD-360 data sheet.
R04	09-Jan-2020	brec	Product / document status updated to Initial Production. Edits for consistency with other BMD-3 modules Corrected pins designated as standard drive (Table1) Removed "Pending" marking for the certifications as they have been completed. Added tolerances to Figure 3
R05	03-Mar-2020	brec	Added type number BMD-360-A-R-10; Added u-blox logo to Figure 3 to show orientation of label; Added label information for new type number in section 5.3; Added ESD precautions in section 10.5; Changed images to be u-blox branded; Added packaging specification for type number BMD-360-A-R-10 in section 10.1
R06	31-Mar-2020	brec	Updated product photo
R07	19-Jul-2021	brec	Added type number BMD-360-A-R-20, Figure 7, added references to nRF Connect SDK
R08	06-May-2022	brec	Added <a href="#">Carrier tape orientation</a> information. Updated product status for type number BMD-360-A-R-00 to Obsolete. Updated <a href="#">Figure 7</a> showing the additional bottom side marking of type number BMD-360-A-R-20. Removed ambiguous description of operating condition ranges in <a href="#">Electrical specifications</a> .

# Contact

For complete contact information, visit us at [www.u-blox.com](http://www.u-blox.com).

## u-blox Offices

### North, Central and South America

#### u-blox America, Inc.

Phone: +1 703 483 3180  
E-mail: [info\\_us@u-blox.com](mailto:info_us@u-blox.com)

#### Regional Office West Coast:

Phone: +1 408 573 3640  
E-mail: [info\\_us@u-blox.com](mailto:info_us@u-blox.com)

#### Technical Support:

Phone: +1 703 483 3185  
E-mail: [support\\_us@u-blox.com](mailto:support_us@u-blox.com)

### Headquarters

#### Europe, Middle East, Africa

#### u-blox AG

Phone: +41 44 722 74 44  
E-mail: [info@u-blox.com](mailto:info@u-blox.com)  
Support: [support@u-blox.com](mailto:support@u-blox.com)

### Asia, Australia, Pacific

#### u-blox Singapore Pte. Ltd.

Phone: +65 6734 3811  
E-mail: [info\\_ap@u-blox.com](mailto:info_ap@u-blox.com)  
Support: [support\\_ap@u-blox.com](mailto:support_ap@u-blox.com)

#### Regional Office Australia:

Phone: +61 3 9566 7255  
E-mail: [info\\_au@u-blox.com](mailto:info_au@u-blox.com)  
Support: [support\\_ap@u-blox.com](mailto:support_ap@u-blox.com)

#### Regional Office China (Beijing):

Phone: +86 10 68 133 545  
E-mail: [info\\_cn@u-blox.com](mailto:info_cn@u-blox.com)  
Support: [support\\_cn@u-blox.com](mailto:support_cn@u-blox.com)

#### Regional Office China (Chongqing):

Phone: +86 23 6815 1588  
E-mail: [info\\_cn@u-blox.com](mailto:info_cn@u-blox.com)  
Support: [support\\_cn@u-blox.com](mailto:support_cn@u-blox.com)

#### Regional Office China (Shanghai):

Phone: +86 21 6090 4832  
E-mail: [info\\_cn@u-blox.com](mailto:info_cn@u-blox.com)  
Support: [support\\_cn@u-blox.com](mailto:support_cn@u-blox.com)

#### Regional Office China (Shenzhen):

Phone: +86 755 8627 1083  
E-mail: [info\\_cn@u-blox.com](mailto:info_cn@u-blox.com)  
Support: [support\\_cn@u-blox.com](mailto:support_cn@u-blox.com)

#### Regional Office India:

Phone: +91 80 405 092 00  
E-mail: [info\\_in@u-blox.com](mailto:info_in@u-blox.com)  
Support: [support\\_in@u-blox.com](mailto:support_in@u-blox.com)

#### Regional Office Japan (Osaka):

Phone: +81 6 6941 3660  
E-mail: [info\\_jp@u-blox.com](mailto:info_jp@u-blox.com)  
Support: [support\\_jp@u-blox.com](mailto:support_jp@u-blox.com)

#### Regional Office Japan (Tokyo):

Phone: +81 3 5775 3850  
E-mail: [info\\_jp@u-blox.com](mailto:info_jp@u-blox.com)  
Support: [support\\_jp@u-blox.com](mailto:support_jp@u-blox.com)

#### Regional Office Korea:

Phone: +82 2 542 0861  
E-mail: [info\\_kr@u-blox.com](mailto:info_kr@u-blox.com)  
Support: [support\\_kr@u-blox.com](mailto:support_kr@u-blox.com)

#### Regional Office Taiwan:

Phone: +886 2 2657 1090  
E-mail: [info\\_tw@u-blox.com](mailto:info_tw@u-blox.com)  
Support: [support\\_tw@u-blox.com](mailto:support_tw@u-blox.com)