



Quartz Crystal Specification

IQD Part No. + Packaging: LFX TAL030798Reel

Würth Part No. 830030798



Description

- Industry standard SMD crystal
Resistance welded, hermetically sealed in an inert atmosphere, glass to metal seals on leads
Lead wires are mounted onto a plastic former to create a gull wing mount
- Model: HC49/4HSMX
- Model Issue number: 17

Frequency Parameters

- Frequency: 3.68640MHz
- Frequency Tolerance: $\pm 30.00\text{ppm}$
- Tolerance Condition: @ 25°C $\pm 2^\circ\text{C}$
- Frequency Stability: $\pm 50.00\text{ppm}$
- Operating Temperature Range: -40.00 to 85.00°C
- Overtone Order: Fundamental
- Ageing: $\pm 5\text{ppm typ per year @ } 25^\circ\text{C}$

Electrical Parameters

- Load Capacitance (CL): 16.00pF
- Shunt Capacitance (C0): 7pF max
- Drive Level: 500 μW max
- ESR: 300.00 Ω max

Environmental Parameters

- Shock: 981m/s², 6ms, 3 times in each of 3 mutually perpendicular planes
- Vibration: 10Hz-60Hz, 0.75mm amplitude, 60Hz-500Hz, 98.1m/s², 30mins in 3 mutually perpendicular planes
- Storage Temperature Range: -55 to 125°C

Manufacturing Details

- RoHS Terminations: SnAgCu or Sn
- RoHS Reflow Temp: 260degC 10s

Compliance

- RoHS Status (2011/65/EU): Compliant
- REACH Status: Compliant
- MSL Rating (JDEC-STD-033): Not Applicable

Packaging Details

- Pack Style: Reel Tape & reel in accordance with EIA-481-D
Pack Size: 1,000
- Alternative packing option available

USEFUL LINKS

Toolbox:

www.we-online.com/toolbox

Product Catalog:

www.we-online.com/products



Outline (mm)

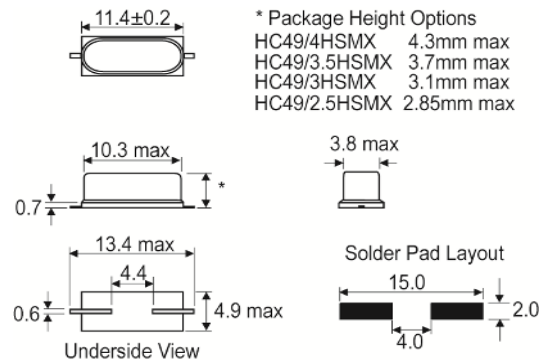

Typical Frequency vs Temperature Curves



CONTACT INFORMATION:

Würth Elektronik eiSos GmbH & Co. KG
Max-Eyth-Str. 1, 74638 Waldenburg, Germany
Tel: +49(0) 7942 945-0

Email: eiSos@we-online.de
Web: www.we-online.com