

Instruction manual for Evaluation Board of TB67S109AFTG

May 10, 2016

Re v.1.0

【Outline】

The TB67S109A is a two-phase bipolar stepping motor driver using a PWM chopper. CLK-IN control system and BiCD process are adopted. Rating of 50V and 4.0A is realized.

This evaluation board mounts necessary components to evaluate the IC. Each excitation drive of full step, half step, quarter step 1/8 step, 1/16 step, and 1/32 step can be run with PWM constant current drive. Please sense low noise and low vibration of the stepping motor.

【Note】

In using, please be careful about thermal condition sufficiently.
As for each control signal, please refer to the IC specification by accessing to the below URL.

<http://toshiba.semicon-storage.com/us/product/linear/motordriver/detail.TB67S109AFTG.html>

Further, the application of this evaluation board is limited to the purpose of evaluating and learning the motor control. Please do not ship them to a market.

Connection to Evaluation board

Corresponding table

(Silk name vs. Signal name)

(Note) Silk name and signal name on the board are different because the series products have the common board.

Silk name	Signal name
L_OUT	NC
38	LO
39	DMODE0
VREFB	VREFB
42	VREFA
OSCM	OSCM
44	CW/CCW
45	MO
46	DMODE1
47	DMODE2
2	CLK
3	ENABLE
4	RESET

Power source of VM (10V to 47V)

Two-phase bipolar type Stepping motor

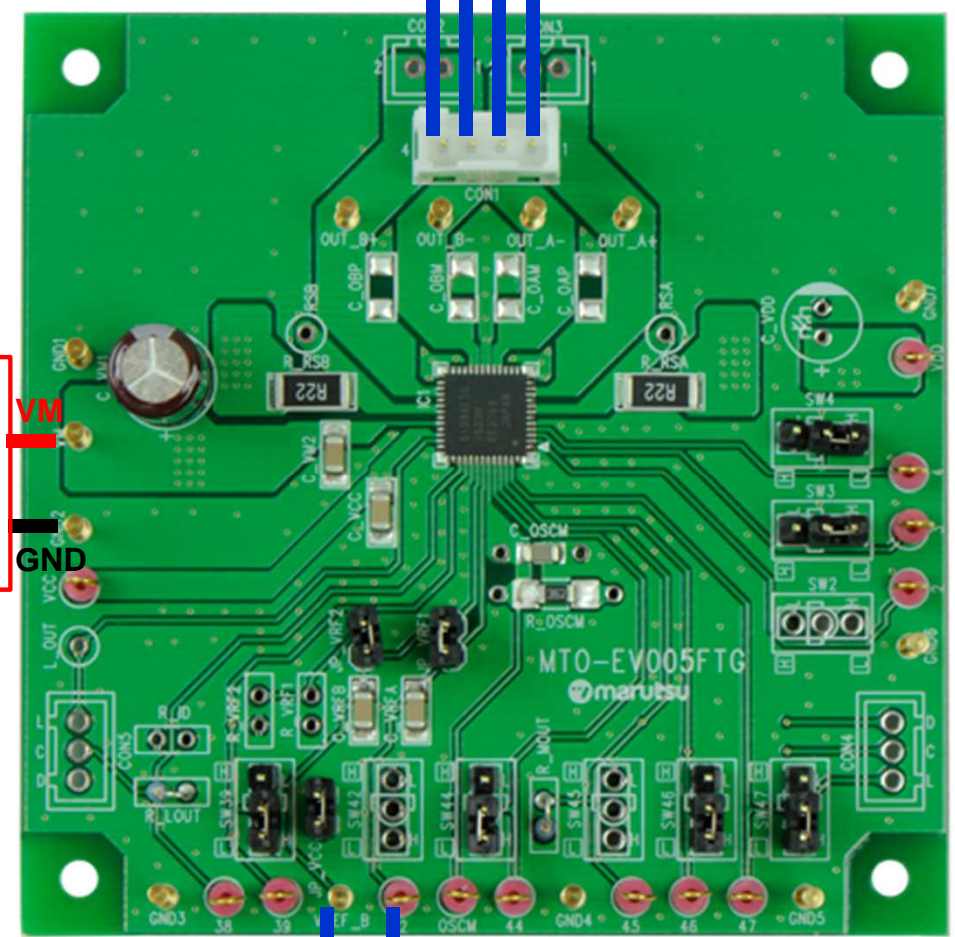

Reference voltage for motor current set Vref (0V to 3.6V)

Setting evaluation board 1

Setting motor current

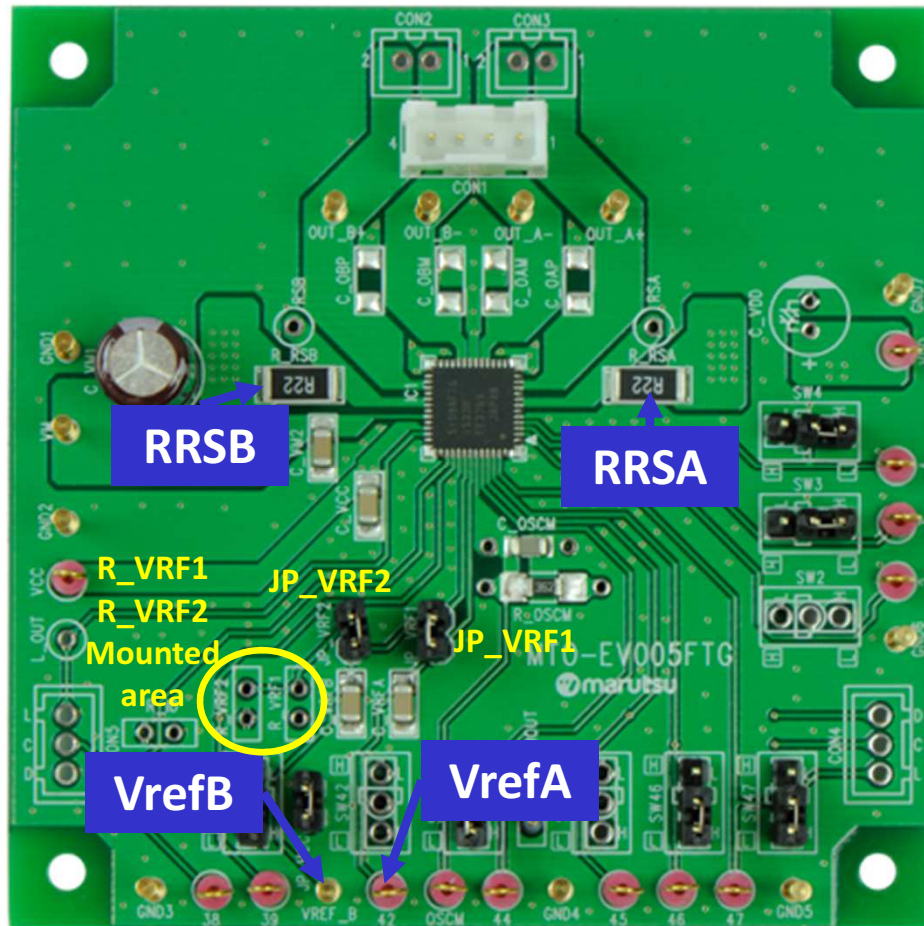

Setting motor current

$$I_{out(max)} = VREF(gain) \times \frac{Vref(V)}{RRS(\Omega)}$$

VREF(gain): Decay ratio of VREF: 1/5.0 (typ.)

RRS=0.22Ω

VREF of A-axis and B-axis are made common by short the jumper (JP_VRF1) and the both voltages are possible to input from VREFA pin. And Vref can be generated from the internal regulator (VCC) by mounting the divider resistance to R_VRF1 and R_VRF2 and short-circuiting JP_VRF2.

Waveform of motor current

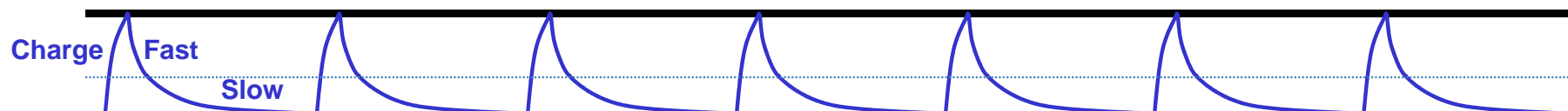

Current value of setting motor

Setting evaluation board2

Setting chopping frequency of the constant current of the motor

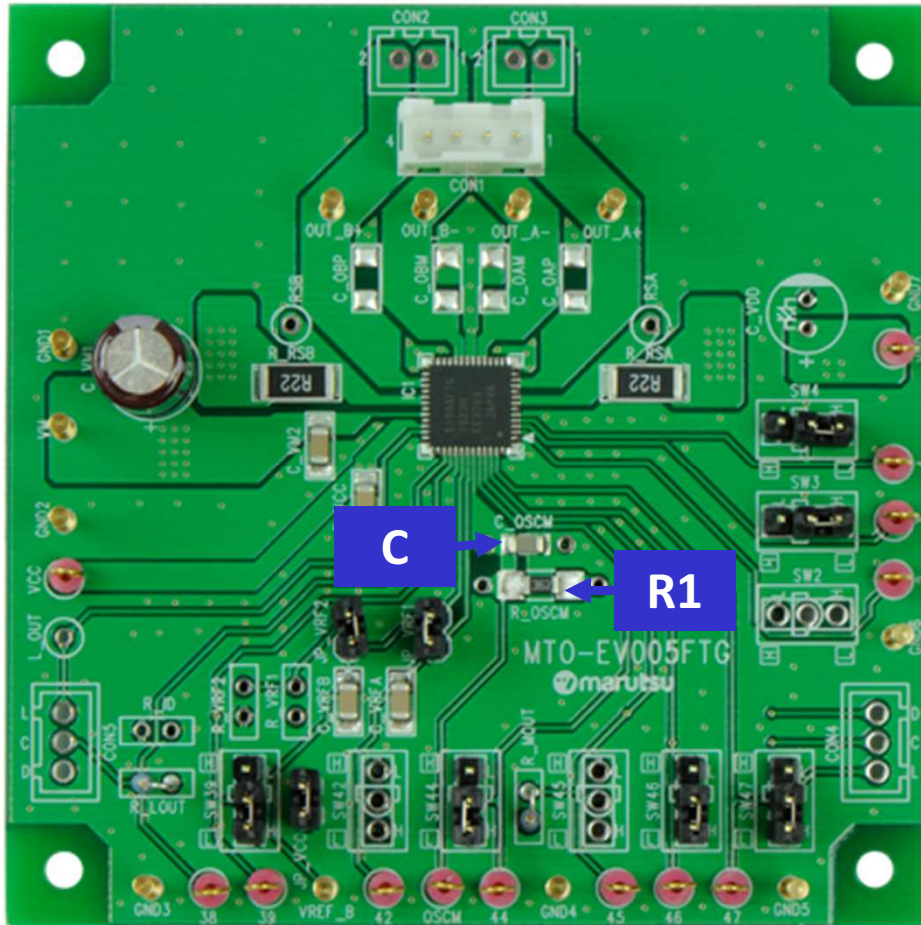

Formula of setting chopping frequency

$$f_{OSCM} = 1 / [0.56 \times \{C \times (R1 + 500)\}]$$

$$f_{chop} = f_{OSCM} / 16$$

Recommended frequency range:

f_{chop} =40kHz to 150kHz

70kHz configuration

Mounted parts are as follows;

Capacitor (C=270pF), Resistance (R1=5.1kΩ)

Waveform of motor current

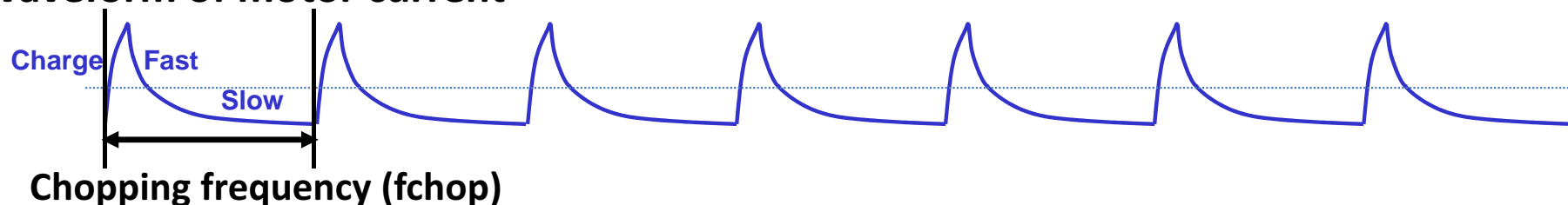

Setting evaluation board3

Setting motor operation

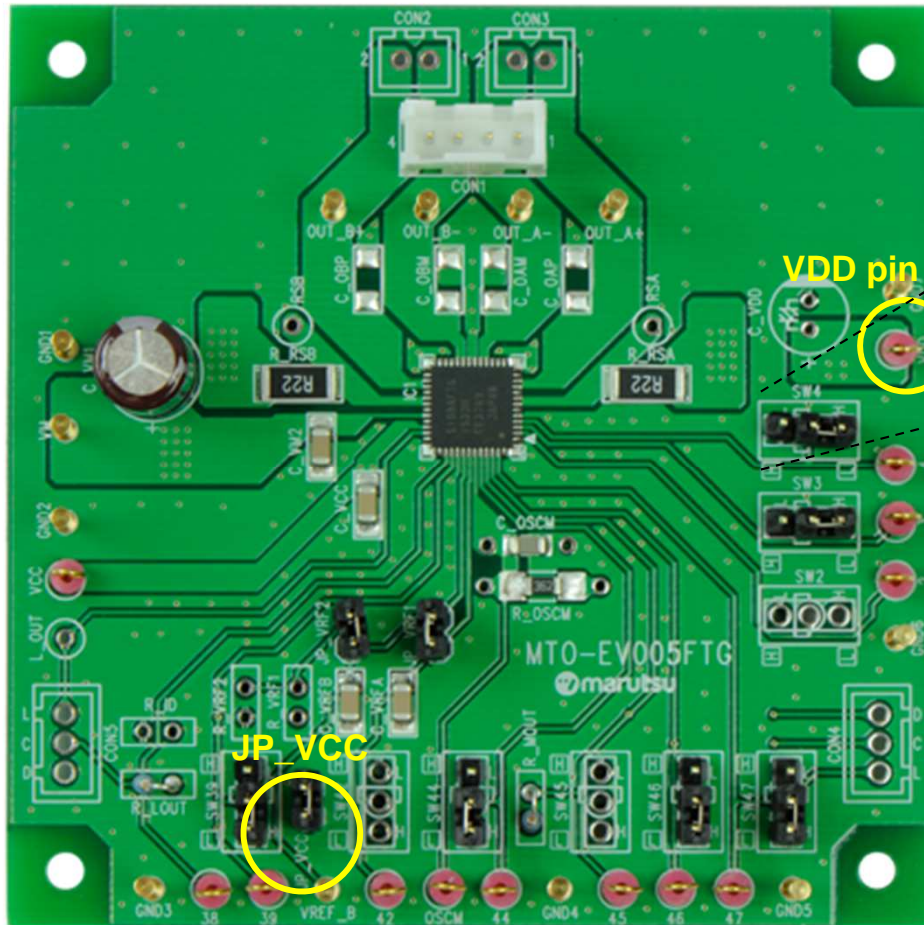

【Enhanced figure of jumper part】

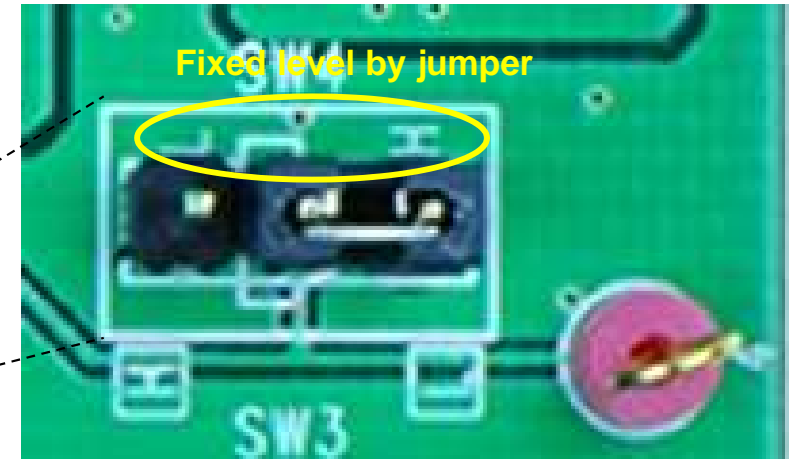

Jumper indicated above is adopted on this evaluation board to set operation of the TB67S109AFTG.

To select the function by the jumper, short-circuit JP_VCC or supply the voltage of high level by VDD pin.

In above, fixed level of the silk near the jumper is indicated inside the white frame. Please change the short position according to the configuration of the usage function.

In case of inputting the signal externally, please remove the short pin.

Circuit of evaluation board

