

EMIRS50 AT06V BR25M

Thermal MEMS based infrared source

For direct electrical fast modulation

TO46 header with Reflector 6

■ Infrared Source

Axetris infrared (IR) sources are micro-machined, electrically modulated thermal infrared emitters featuring true blackbody radiation characteristics, low power consumption, high emissivity and a long lifetime. The appropriate design is based on a resistive heating element deposited onto a thin dielectric membrane which is suspended on a micro-machined silicon structure.

■ Infrared Gas Detection Applications

- **Measurement principles:** non-dispersive infrared spectroscopy (NDIR), photoacoustic infrared spectroscopy (PAS) or attenuated-total-reflectance FTIR spectroscopy (ATR)
- **Target gases:** CO, CO₂, VOC, NO_x, NH₃, SO_x, SF₆, hydrocarbons, humidity, anesthetic agents, refrigerants, breath alcohols
- **Medical:** Capnography, anesthesia gas monitoring, respiration monitoring, pulmonary diagnostics, blood gas analysis
- **Industrial Applications:** Combustible and toxic gas detection, refrigerant monitoring, flame detection, fruit ripening monitoring, SF₆ monitoring, semiconductor fabrication
- **Automotive:** CO₂ automotive refrigerant monitoring, alcohol detection & interlock, cabin air quality
- **Environmental:** Heating, ventilating and air conditioning (HVAC), indoor air quality and VOC monitoring, air quality monitoring

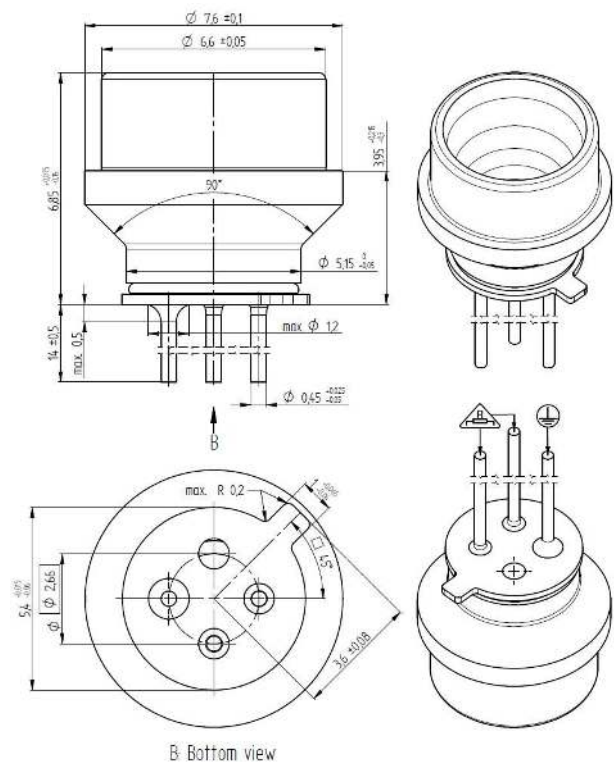

■ Features

- Large modulation depth at high frequencies
- Broad band emission
- Low power consumption
- Long lifetime
- True black body radiation (2 to 14 μm)
- Very fast electrical modulation (no chopper wheel needed)
- Suitable for portable and very small applications
- Rugged MEMS design

■ Absolute Maximum Ratings ($T_A = 22^\circ\text{C}$)

Parameter	Symbol	Rating	Unit
Heater membrane temperature ¹	T_M	500	$^\circ\text{C}$
Optical output power (hemispherical spectral) ($T_M = 500^\circ\text{C}$)	P_{00}	4.7	mW
Optical output power between 4 μm and 5 μm ($T_M = 500^\circ\text{C}$)	P_{s4-5}	0.68	mW
Optical output power between 6 μm and 8 μm ($T_M = 500^\circ\text{C}$)	P_{s6-8}	0.89	mW
Optical output power between 8 μm and 10 μm ($T_M = 500^\circ\text{C}$)	P_{s8-10}	0.54	mW
Optical output power between 10 μm and 13 μm ($T_M = 500^\circ\text{C}$)	P_{s10-13}	0.44	mW
Electrical cold resistance (at $T_M = T_A = 22^\circ\text{C}$)	R_{C22}	22 to 36	Ω
Electrical operating (hot) resistance ² (at $T_M = 500^\circ\text{C}$ with $f \geq 10 \text{ Hz}$ and $t_{on} \geq 3 \text{ ms}$)	R_{H500C}	$1.555 * R_{C22} - 3.618$	Ω
Package temperature	T_P	80	$^\circ\text{C}$
Storage temperature	T_S	-20 to +85	$^\circ\text{C}$
Ambient temperature ³ (operation)	T_A	-40 to +125	$^\circ\text{C}$
Heater area	A_H	0.8 x 0.8	mm^2
Frequency ⁴	f	10 to 100	Hz

Note: Emission power in this table is defined by hemispherical radiation. Stress beyond those listed under “absolute maximum ratings” may cause permanent damage to the device.

Note: Diagram $R_{H500C} - R_{C22} \mid (T_M = 500^\circ\text{C})$

How to ensure that the maximum temperature for T_M is not exceeded:

1. Determine electrical cold resistance R_C of the EMIRS device at $T_A=22^\circ\text{C}$
2. Ensure that anytime R_H does not exceed the representative limit as shown in this diagram with respect to these conditions:
 - a. $f \geq 10 \text{ Hz}$
 - b. on-time (pulse duration) $\geq 3 \text{ ms}$

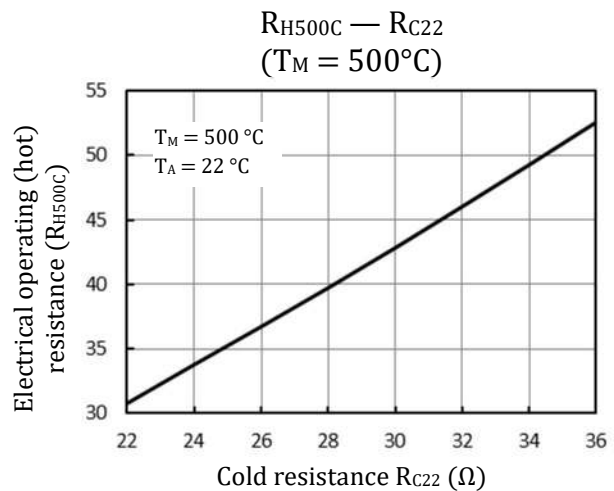

Electrical operating (hot) resistance R_H versus electrical cold resistance R_{C22} at $T_A = 22^\circ\text{C}$

¹ Temperatures above 500°C will impact drift and lifetime of the devices.

² See Diagram $R_H - R_C \mid (T_M = 500^\circ\text{C})$

³ The environmental and package temperature might impact the lifetime and characteristic of the devices.

⁴ Lower cut-off frequency of 10 Hz for designed thermodynamic state. DC drive is also possible but recommended with “soft-off” switch.

■ Ratings at Reference Operation (RO¹ T_A = 22°C)

Parameter	Symbol	Rating	Unit
Heater membrane temperature	T _M	< 500	°C
Duty cycle of rectangular V _H pulse	D	62	%
Frequency of rect. pulse shape ²	f _{ref}	10	Hz
On time constant of integral emissive power P ₀₀	τ _{on}	10	ms
Off time constant of integral emissive power P ₀₀	τ _{off}	5	ms
Package temperature at T _A = 22°C	T _P	40 to 50	°C

Note: First order on-time model using τ_{on}: First order off-time model using τ_{off}:

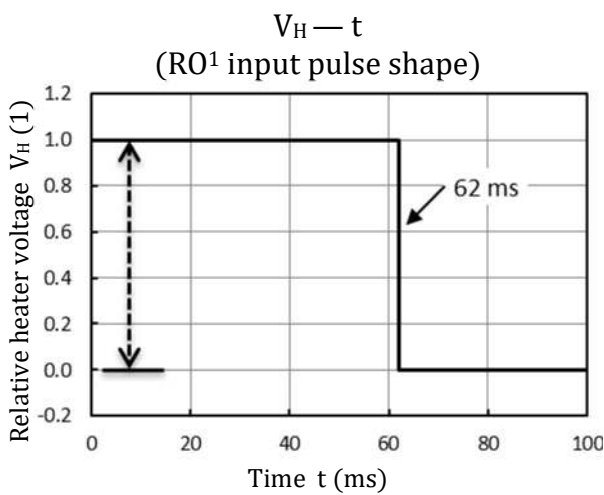

Relative rectangular heater voltage (V_H) pulse with a relative pulse width of 62 ms at 10 Hz (time description of reference operation RO¹)

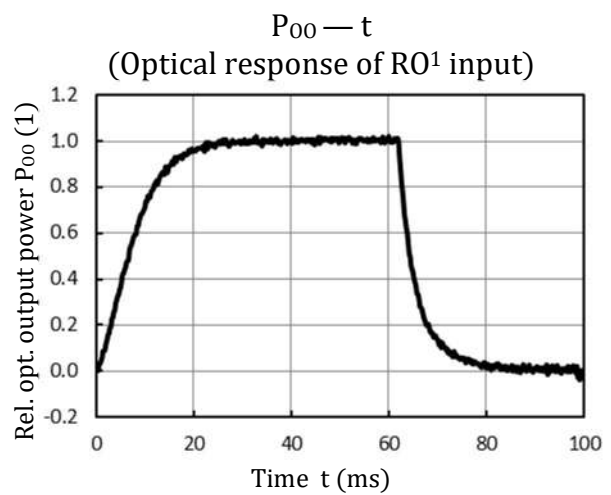

Optical response time (relative optical output power P₀₀) of a rectangular voltage pulse (RO¹ conditions)

¹ Reference Operation: combines lower cut-off frequency of 10 Hz and maximum modulation depth (max-min signal)

² Recommended frequencies from 10 Hz to 100 Hz

■ Typical Timing Characteristics Frequency (D = 62%)

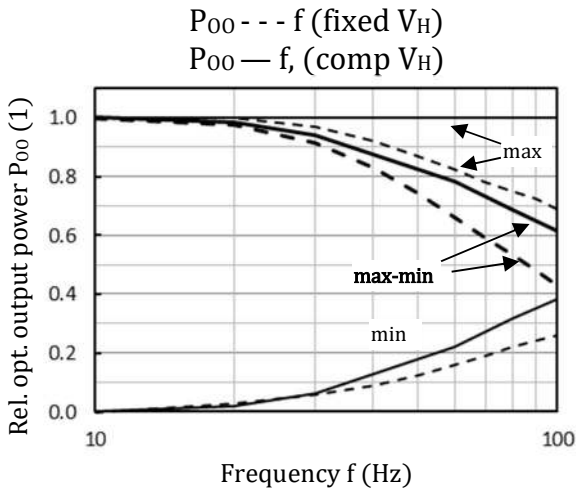

Relative (to RO) max, min, max-min values of optical output power (P_{00}) versus frequency f with fixed and compensated V_H

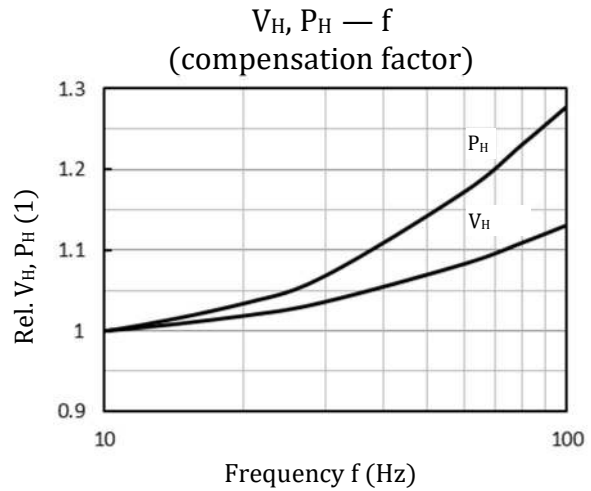

Relative (to RO) electrical drive values heater voltage V_H and power P_H versus frequency f for compensation

Note: Diagrams a, b

Relative P_{00}, V_H, P_H to reference operation (RO)
 $f=10$ Hz, rect. pulse $D=62\%$

max: maximum value of P_{00} response shape
min: minimum value of P_{00} response shape
max-min: amplitude calculation of P_{00} resp. shape

Fixed V_H : same voltage for all frequencies.

Compensated V_H : for every frequency value, the voltage is adjusted to achieve the same maximum of P_{00} response shape as for 10 Hz.

■ Typical Timing Characteristics Pulse Duration D¹ (f = 100 Hz)

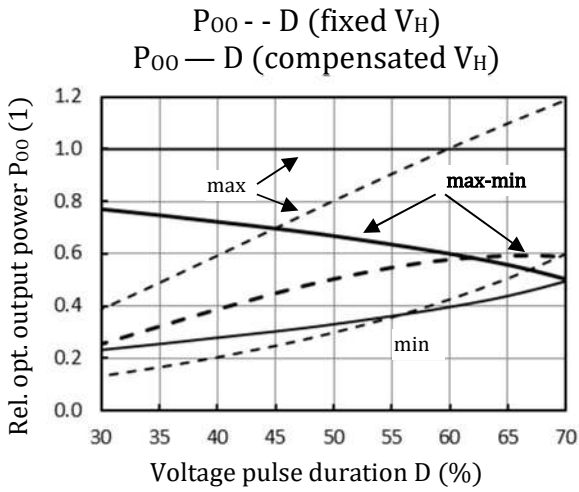

Relative (to D=62%) max, min, max-min values of optical output power (P₀₀) versus duty cycle D with fixed and compensated V_H

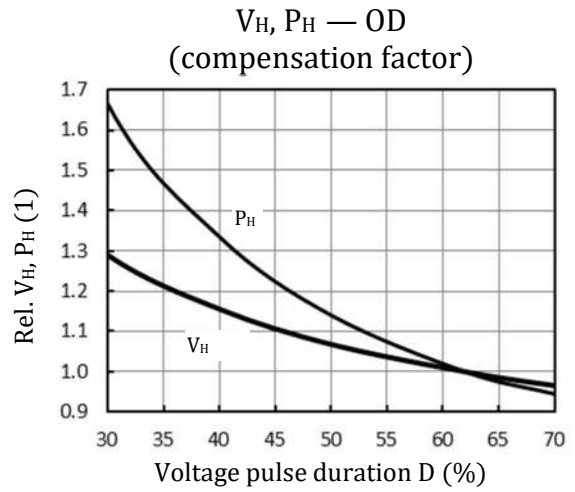

Relative (to R₀) electrical drive values heater voltage V_H and power P_H versus duty cycle D for compensation

Note: Diagrams a, b

Relative P₀₀, V_H, P_H to reference operation (R₀)
f=100 Hz, rect. voltage pulse

max: maximum value of P₀₀ response shape

min: minimum value of P₀₀ response shape

max-min: amplitude calculation of P₀₀ resp. shape

Fixed V_H: same voltage for all frequencies.

Compensated V_H: for every frequency value, the voltage is adjusted to achieve the same maximum of P₀₀ response shape as for D=62%.

¹ Effective D shorter than 30% and voltage or power compensation at high frequencies (e.g. 20% @ 100 Hz) might impact the lifetime and characteristic of the devices because of additional stress in material layers.

■ Typical electrical/thermal characteristics (RO, T_A = 22°C)

Parameter	Symbol	Rating	Unit
Peak chip membrane temperature	T _M	460	°C
Heater voltage	V _H	2.69	V
Heater power	P _H	187	mW

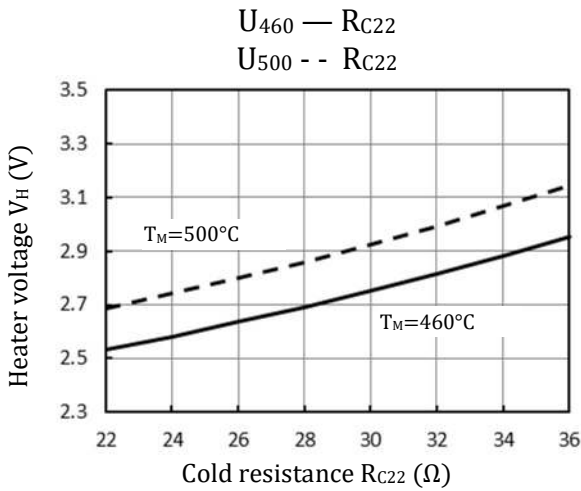

Mean¹ and upper bound of heater voltage V_H vs. cold resistance R_{C22}

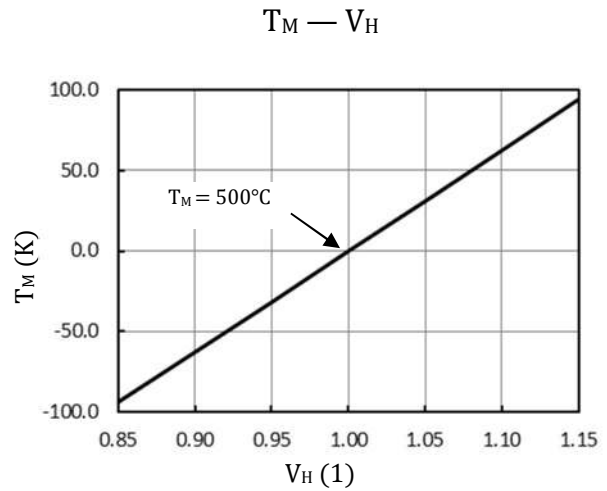

Relative change of membrane temperature (T_M) by changing heater voltage (V_H)

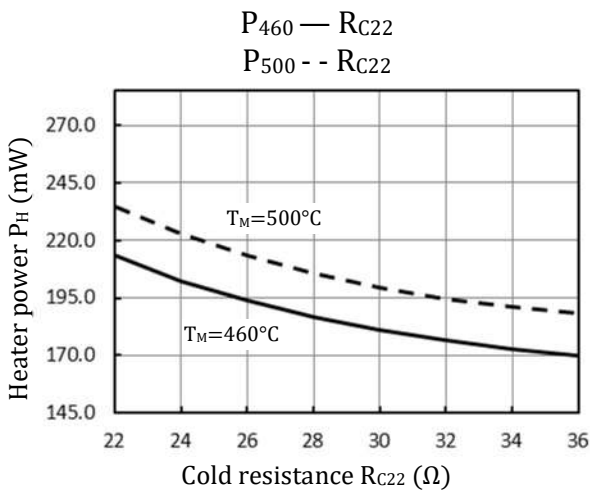

Mean¹ and upper bound of heater power P_H vs. cold resistance R_{C22}

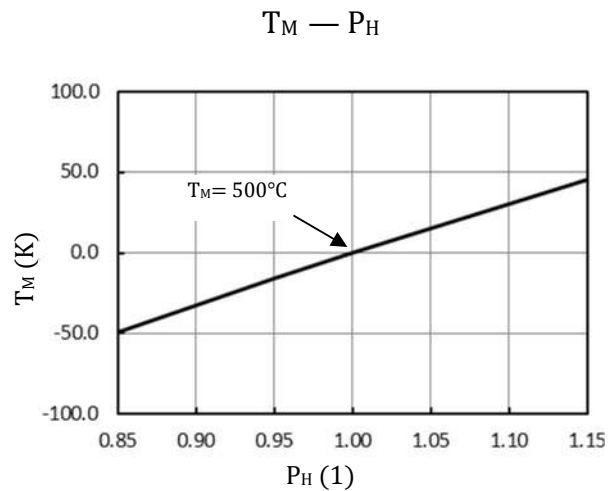

Relative change membrane temperature (T_M) by changing heater power (P_H)

¹ Recommended operation mode T_M = 460°C, which ensures 95% confidence that the maximum temperature T_M = 500°C is not exceeded.

■ Typical Optical Characteristics (RO, $T_A = 22^\circ\text{C}$)

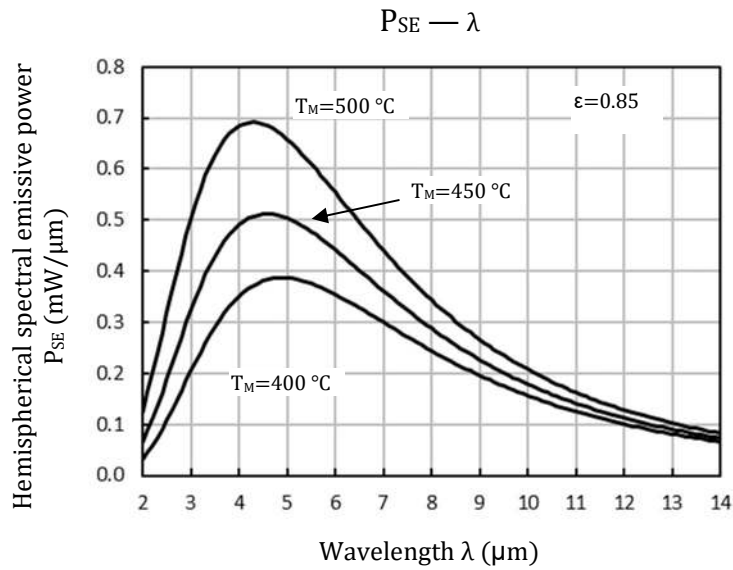

Hemispherical spectral emissive power of EMIRS50 chip surface with a typical emissivity (mean from 2 to 14 μm) of $\epsilon=0.85$

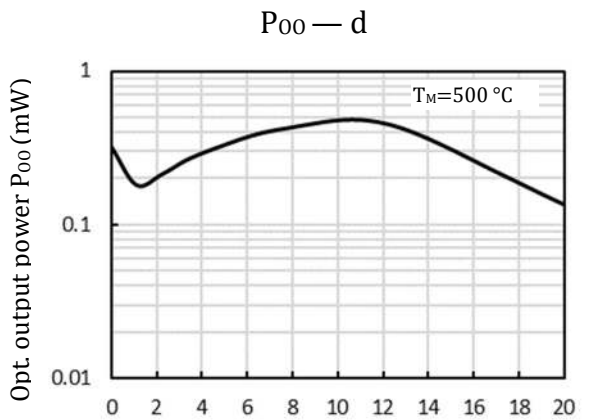

Optical output power (P_{00}) versus distance d of a 1 mm² detection surface at 500°C T_M

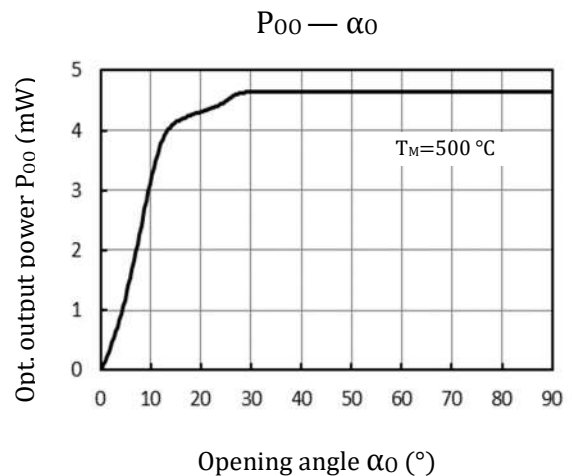

Optical output power (P_{00}) versus opening angle α_0 (integral rotation of a cone) at 500°C T_M

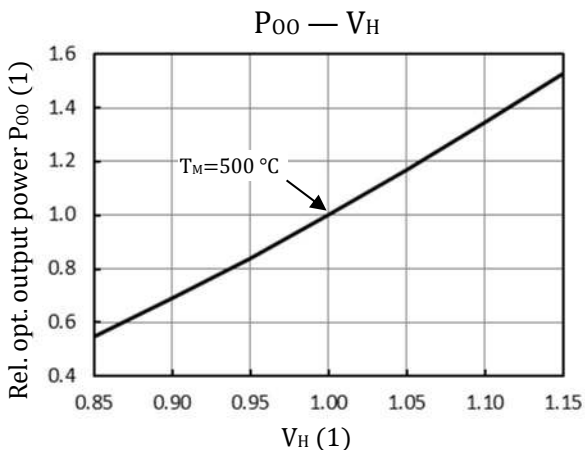

Relative change of optical output power (P_{00}) by changing heater voltage (V_H)

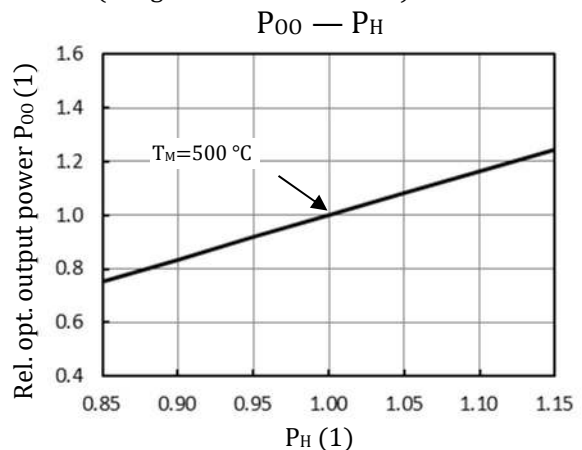

Relative change of optical output power (P_{00}) by changing heater power (P_H)

■ Specified Ratings at Test Voltage V_T (on-time ≥ 20 ms, $T_H = T_A = 22^\circ\text{C}$)

Parameter	Symbol	Condition	Typical value	Unit
Test voltage (for $T_M \approx 500^\circ\text{C}$)	V_T	$T_H = T_A = 20^\circ\text{C}$	$0.0295 * R_{C22} + 2.1271$	V
Optical output power (after 20 ms on)	P_{00}	after ≥ 20 ms V_T on time, $T_P = T_A = 22^\circ\text{C}$	4.50	mW

Note: Other optical output specifications are possible by customer specific requirements (e.g. spectral ranges).

Note: Diagram $V_{T500C} - R_{C22} | (T_M \approx 500^\circ\text{C})$

Defined test voltage V_T for specified ratings:

1. Determine electrical cold resistance R_{C22} of the EMIRS device at $T_A = 22^\circ\text{C}$
2. Drive the device with V_T for each R_C as shown in this diagram.
3. Ratings are only valid for $T_P = T_A = 22^\circ\text{C}$ and after 20 ms on-time.

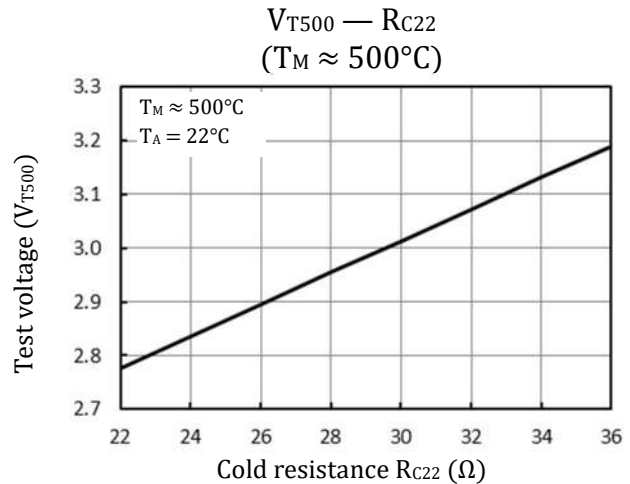

Test voltage V_T versus electrical cold resistance R_{C22} at $T_A = 22^\circ\text{C}$