



# Flambeau®

Distinctive Packaging For Quality Brands And Products™





# Flambeau®

Distinctive Packaging For Quality Brands And Products™



## Single Source Solutions ... In Plastic

Flambeau® Inc. is a worldwide industry leader in thermoplastic manufacturing, specializing in both injection and blow molding. Our unique competitive advantage is the ability to offer the largest array of proprietary stock plastic packaging and storage products ... along with countless customization options.

*Consider Flambeau Packaging as Your "Art to Part" Source!*

### Full range of services:

- Part design
- Mold design
- Manufacturing and assembly
- Various product fulfillment programs
- Prototyping
- Sampling
- Custom quoting

### Flambeau Inc. History

Flambeau Packaging, a division of Flambeau Inc. has been doing business since 1947. Headquartered in Baraboo, WI, we pride ourselves in being a family owned company. We foster core values such as Family, Integrity, Leadership, Teamwork and Knowledge for the pursuit of Excellence with people who care ... and who are committed to providing you professional service when you need it!

### Customer Service: 1(800)344-5716

Our professional customer service associates are eager to help answer questions and solve problems! You can contact us toll free for guidance and great customer care.

We encourage you to examine all we have to offer at our website: [flambeaucases.com](http://flambeaucases.com)



### Express Service<sup>SM</sup>

Offers one unit to single carton quantities of in-stock cases to be shipped within 24 business hours. Qualifying products are marked with a **E** symbol.



### Special Order / Non-Stock Products

Most products are in-stock and ready to ship, but non-stock products are marked in the catalog as **S** and are available with reasonable lead-times.



### ECO Friendly Products

Flambeau's Packaging Divisions offers 100% recyclable storage cases and boxes. Ensures customer disposal of product lessens their carbon footprint on the environment & provides additional value to items. Can be manufactured and made available in most products with production quantities as low as 1,000 pieces.

## Customer Service



Our professional customer service associates are eager to help answer questions and solve problems! You can contact us toll free for guidance and great customer care.

Customer Service: 1(800) 344-5716

For your convenience and order processing speed we accept:



### Hot Stamp Labeling

An economical way to customize with up to two colors. *\*Injection mold products only*



### Engraving

We use lid and base inserts on our stock boxes and cases. This allows you the flexibility to insert a custom engraved company logo and/or design plate on one or both sides. *\*Injection or blow mold products*



### In-Mold Decorating

High quality, multi-color graphic labeling. The result - better product presentation with guaranteed straight, crisp, clear graphics that are impervious to most chemicals. *\*Injection or blow mold products*





## Adhesive Labels

Adhesive-backed labels available and factory supplied. *\*Injection mold products only*



## Custom Interiors

Choose from custom mold interiors or custom foam interiors for that polished, professional look.



Mold Interior

Foam Interior

## Color Options

Flambeau offers a selection of color resins. Custom blended colors available upon request.





**No Rust With Zerust®**

Zerust® has proven to be the absolute best way to protect your equipment against rust & corrosion. The Zerust VCI (Vapor Corrosion Inhibitor) is mold-  
ed directly into many Flambeau® products. Zerust's

patented polymer emits a harmless vapor, forming a protective layer around metal surfaces. All Zerust products will maintain their effectiveness for up to five years of hassle free, long lasting protection.

Look for the Zerust symbol next to those products that feature this revolutionary technology. This is just another innovation from Flambeau... your most trusted source in storage.

*Flambeau Zerust helps to increase efficiency, saves money and, most importantly, protect tools and hardware from rust and tarnish.*

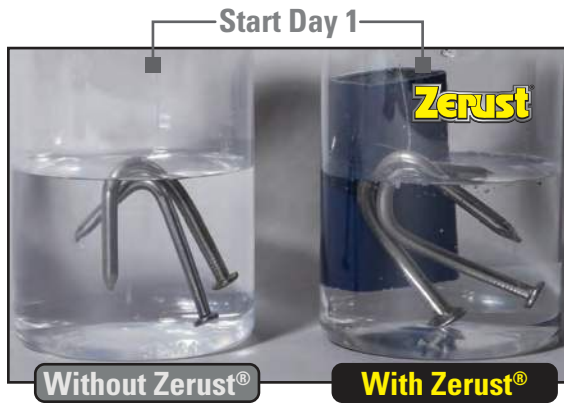

Zerust® is a registered trademark of Northern Technologies International Corporation (NTIC). ©2021 Flambeau Inc.

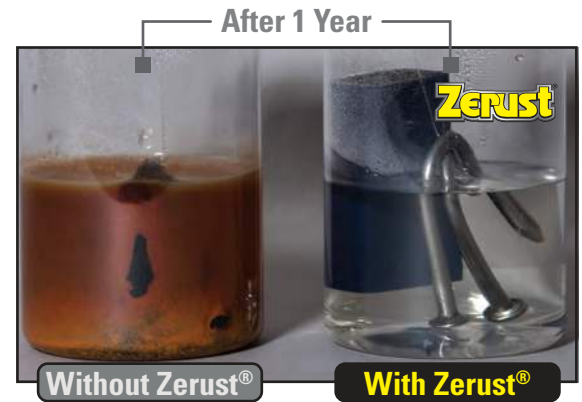
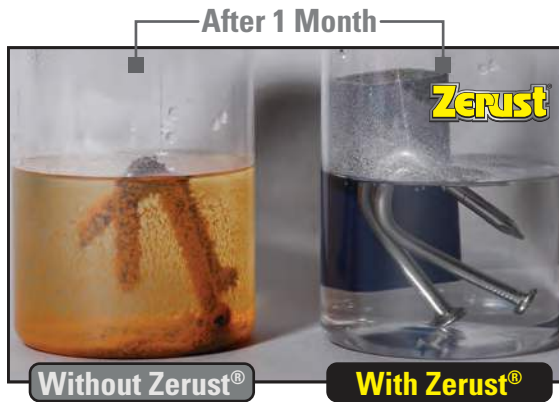
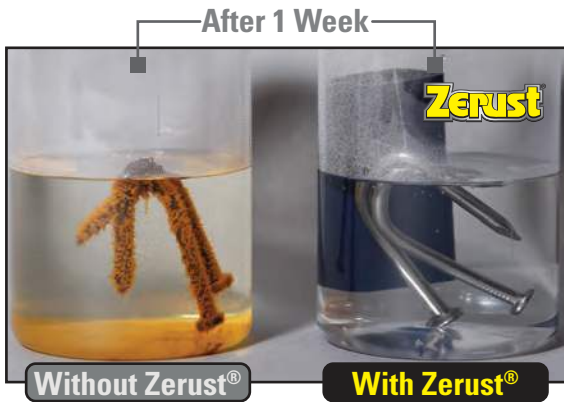

Zerust® is the oldest, most proven effective VCI, (Vapor Corrosion Inhibitor) in the industry! Flambeau®

Zerust Anti-Tarnish provides a solution to the corrosion problem by providing a safe, long-term protective shield. This additive

forms a harmless protective layer preventing tarnishing for up to five years.

Flambeau stocks select Super Satchels™ and Tuff Tainers® with Anti-Tarnish or Zerust molded directly into the product. Most products incorporating the Anti-Tarnish or Zerust features are available through our Special Order Program and may require certain minimum quantities.

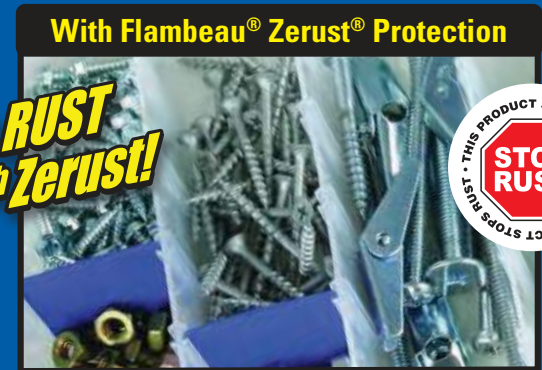





### Zerust® Dividers:

Having Zerust molded directly into the dividers themselves creates a harmless vapor barrier around your parts inhibiting corrosion for up to five years (see first chart).



Zerust is a registered trademark of Northern Technologies International Corporation.



### Anti-Tarnish Dividers:

Molded directly into the dividers forming a harmless protective layer around non-ferrous metals such as silver, gold and copper and will prevent tarnishing for up to 5 years!



To order Anti-Tarnish dividers for your specific Tuff Tainer® or Super Satchel™

MODEL #	PAGE	SETS TO A PACK	ORDER #
T4007AT	119	12	Bulk 601916
T5007AT	120	12	Bulk 601909
T9101AT	72	12	600924



### Dividers With Zerust

Order info for specific Tuff Tainers® or Super Satchels™

MODEL #	PAGE	PER PACK	ORDER #
T2003	119	15	2012ZP
T3003	119	12	3312ZP
T4007	119	12	4715ZP
T4008	119	12	4715ZP
T5007	120	12	5715ZP
T5008	120	12	5715ZP
T6004	120	12	6012ZP
T7003	120	12	7012ZP
T7004	121	12	7012ZP
T9101	72	12	5715ZP
T9007	72	12	9012ZP



### Standard Dividers

MODEL #	PAGE	PER PACK	ORDER #	BULK ORDER #
T1002	119	12	1012DP	601331
T2003	119	15	2012DP	601321
T3003	119	12	3715DP	601972
T4004	119	12	-	601973
T4007	119	12	4715DP	601974
T4008	119	12	-	601917
T5003	120	12	-	601975
T5007	120	12	5715DP	601976
T5008	120	12	-	601918
T6004	120	12	6012DP	601329
T7003	120	12	7012DP	601332
T7004	121	12	7012DP	601332
T9101	72	12	5712DP	601365
T9007	72	12	9012DP	601372



### Infinite Divider System™ (IDS) Dividers:

Unique patented system that allows you to place dividers exactly where you need them...every 1/16" (0.16 cm).

**No wasted space!**

To Order IDS Dividers:

MODEL #	PAGE	PER PACK	ORDER #	BULK ORDER #
T300	131	8	3108DP	601316
T600	131	8	6108DP	601308
999-2	131	8	9108DP	601310
T900	131	8	9108DP	601310

To Order IDS Dividers With ZERUST®

T300	131	Individually Sold	601342	-
T600	131	12	6108ZR	-
999-2	131	12	9108ZR	-
T900	131	12	9108ZR	-



# Distinctive Packaging For Quality Brands And Products™

**NEW**

## 6535TH Contractor Clipboard

Rugged notebook with many features. Don't leave home without it!

See page 58



Made in China



**NEW**

6792TC



## Merchant Case 19"

All purpose "over-sized" case provides tons of storage

See page 12

**NEW**

6773TC



## Merchant Case 12"

**NEW**

6778TD



## Merchant Case 14"



**NEW**



## Flambeau® Zerust® Toolboxes

Tool boxes come with patented Zerust Anti-Rust protection to keep your tools and fasteners from rusting.

See pages 56 - 58



9118ZR

9219ZR

9218ZR

9226ZR

9222ZR



# Distinctive Packaging For Quality Brands And Products™

## DOCU-BOX™

Protect owner manuals and product literature from adverse conditions.

See page 40



## Static Dissipative Slim Line™ Boxes

The Static Dissipative Slim Line™ Box has been engineered to protect ESDs (electrostatic-sensitive devices). This box is manufactured with static dissipative material.

See page 90



NEW

## 6750HS Big Mouth™ Toolbox

This compact utility toolbox is made of olive green polypropylene and features an increased storage volume base, carry handle, comfortable snap-shut latch and two lock holes for added security.

See page 68

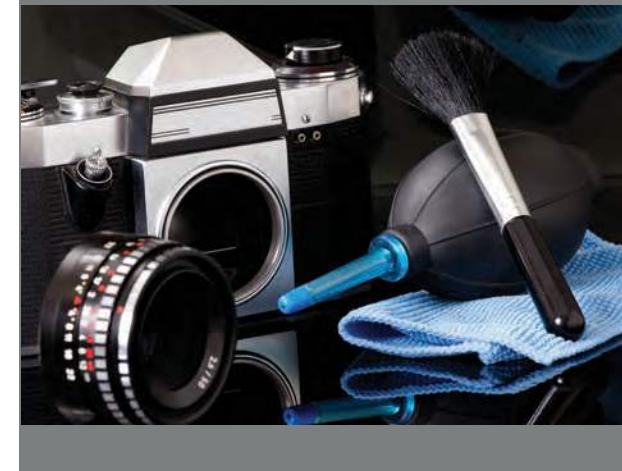

Distinctive Packaging For Quality Brands And Products™

NEW

Ammo Boxes

These Gear Boxes are perfect for Firearm Supplies, Medical Supplies, safety equipment, Auto Repair Kits, Test Equipment, Art Supplies, Maintenance Supplies and much more.

See page 17



7425GB

Shotshell Gear Box with Removable Dividers



7415GB

Shotshell Gear Box

NEW

8415GB HD Gear Box

Perfect for Firearm Supplies, Medical Supplies, safety equipment, Auto Repair Kits, Test Equipment, Art Supplies, Maintenance Supplies and much more.

See Page 18



NEW

AS1209 Atlas 12 Case

The Atlas 12 Case is built with heavy wall, high-impact polypropylene material and is waterproof when submerged. The Atlas 12 is designed to be ATA (Air Transport Association) compliant.

See page 46



Metal insert lock holes located to side of each latch for added security



Over-center latches, automatic pressure relief valve and overmold handle



# Distinctive Packaging For Quality Brands And Products™

**NEW**

## 5114NK Double Coverage™ Rifle Case

Two walls of protection fits scoped rifles or shotgun up to 47.5" long.

See pages 43 and 54



The Double Coverage Case is designed to hold one scoped rifle or shotgun up to 47.5" long



Air pockets between the two walls provide superior shock and impact protection

## Pallet Packer

Flambeau's NEW Pallet Packer stacks securely and squarely on a 48" x 40" pallet. Excellent for rifles.

Saves thousands of dollars on freight by not only stacking up to 2,880 cases (4610PP) per truck load, but it also fits within UPS/FedEx limits.

See page 52



**NEW**

4610PPB



**NEW**

5010PPB



**NEW**

## 1250STP Shotshell Storage Tray

Holds (50) shotgun shells.

See page 17



# Merchant™ Cases

All Merchant™ Cases employ shallow lid with deep base functionality. Slide open/shut lockable latches with bead-line seal fit between base and lid complete this unique line.



An off-set handle design provides excellent centered balance grasp between the lid & base.



Cases 10, 12 14, 15 & 19 are available in black or translucent

Merchant™ Cases are split 25-75 - shallow lid with deep base functionality!



**6767TC**  
**Merchant 7"**



**6772TC**  
**Merchant 10"**



**6773TC**  
**Merchant 12"**



**6778TD**  
**Merchant 14"**



**6782TC**  
**Merchant 15"**



**6792TC**  
**Merchant 19"**



Optional (2) layers of foam in the base for added protection!

**NEW**

**Merchant 19"**

The 19 inch is the newest & largest addition to our popular Merchant Case product line. This case is designed to have four sliding latches with lock holes for increased security, in addition to offering the same 25 - 75 lid to base split & integral recessed off-set handle.

## Case Options:



Without Foam



With Foam

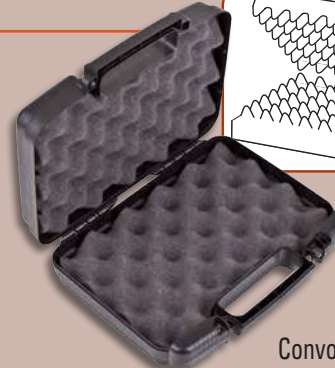
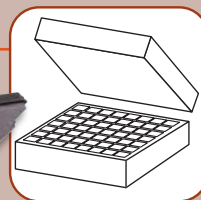

Convoluted Foam

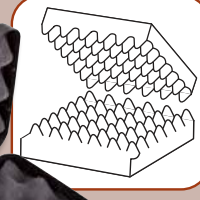

Convoluted and Diced Foam or a combination of foam

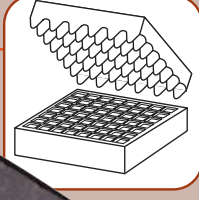





**6783TC 6783TC**

**Merchant 15"**

Off-Set Handle,  
Removable Tray,  
Divided Base and 16 Dividers

Patent # D650, 585 # D633, 294



**6786TC 6786TC**

**Merchant 15"**

Off-Set Handle,  
Divided Base and 12 Dividers



*\* Express Service (E Symbol) items are for quantities 500 and less. For greater quantities call customer service: 1-800-344-5716.*

MODEL #	STOCK #	DESCRIPTION	DIMENS (INSIDE: L x W x D)	PACKED
<b>6767TC</b>	6767TC	7.0" (17.78 cm) Black - w/Out Foam	6-1/2" x 4-1/5" x 2.0", (16.51 x 10.67 x 5.08 cm)	12/ctn
<b>6767TN</b>	6767TN	7.0" (17.78 cm) Translucent Clear and Convoluted Foam Base	6-1/2" x 4-1/5" x 2.0", (16.51 x 10.67 x 5.08 cm)	12/ctn
<b>6772TC</b>	6772TC	10.0" (25.40 cm) Black - w/Out Foam	9.0" x 6-1/2" x 2-3/8", (22.86 x 16.51 x 6.03 cm)	12/ctn
<b>6772TF</b>	6772TF	10.0" (25.40 cm) Black - w/Flat Foam Lid and Convoluted Foam Base	9.0" x 6-1/2" x 2-3/8", (22.86 x 16.51 x 6.03 cm)	12/ctn
<b>6772TD</b>	6772TD	10.0" (25.40 cm) Translucent Clear - w/Out Foam	9.0" x 6-1/2" x 2-3/8", (22.86 x 16.51 x 6.03 cm)	12/ctn
<b>6772TB<sup>®</sup></b>	6772TB	10.0" (25.40 cm) Black/ECO - w/Out Foam	9.0" x 6-1/2" x 2-3/8", (22.86 x 16.51 x 6.03 cm)	12/ctn
<b>6773TC</b>	6773TC	12.0" (30.48 cm) Black - w/Out Foam	11.0" x 7.0" x 3-1/2", (27.94 x 17.78 x 8.89 cm)	10/ctn
<b>6778TD</b>	6778TD	14.0" (35.56 cm) Black - w/Out Foam	13-3/4" x 7-1/2" x 3-1/4", (34.93 x 19.05 x 8.26 cm)	10/ctn
<b>6782TC</b>	6782TC	15.0" (38.10 cm) Black - w/Out Foam	14.0" x 11.0" x 3-2/5", (35.56 x 27.94 x 7.94 cm)	6/ctn
<b>6782TD</b>	6782TD	15.0" (38.10 cm) Trans. Clear - w/Out Foam	14.0" x 11.0" x 3-2/5", (35.56 x 27.94 x 7.94 cm)	6/ctn
<b>6783TC</b>	6783TC	15.0" (38.10 cm) Black w/Tray, Divided Base and 16 Dividers	14.0" x 11.0" x 3-2/5", (35.56 x 27.94 x 7.94 cm)	6/ctn
<b>6786TC</b>	6786TC	15.0" (38.10 cm) Black - w/Divided Base and 12 Dividers	14.0" x 11.0" x 3-2/5", (35.56 x 27.94 x 7.94 cm)	6/ctn
<b>6792TC</b>	6792TC	19.0" (48.26 cm) Black - w/Out Foam	19-15/32" x 12-17/64" x 4-9/32", (49.45 x 31.17 x 10.87 cm)	6/ctn
<b>6992TF</b>	6992TF	19.0" (48.26 cm) Black -w/Diced Foam	19-15/32" x 12-17/64" x 4-9/32", (49.45 x 31.17 x 10.87 cm)	6/ctn

# Tradesman™ Cases

*The Original!* Any other case resembling this style is a knock-off! Slide open/shut lockable latches with bead-line seal fit between base and lid complete this unique line.



Tradesman™ Cases are split 50-50



Centered Handle



6775TC

Tradesman 10.5"



Off-Set Handle



6777TC

Tradesman 12"



Centered Handle



6780TC

Tradesman 14"



Centered Handle



6785TC

Tradesman 17"

## Case Options:



Black



Translucent Clear  
Available Sizes 10, 14  
and 17



Translucent Blue  
Available Sizes 10  
and 14



Without Foam

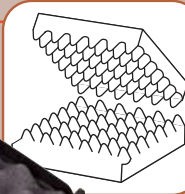

Convoluted  
Foam

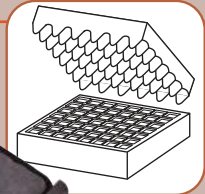

Convoluted  
and Diced Foam





# The Tradesman™ Case

\* Express Service (E Symbol) items are for quantities 500 and less. For greater quantities call customer service: 1-800-344-5716.

MODEL #	STOCK #	DESCRIPTION	DIMENS (INSIDE: L x W x D)	PACKED
<b>6775TC</b>	6775TC	10-1/2" (26.67 cm) Black -	9-1/2" x 5-3/4" x 2-3/4", (24.13 x 14.61 x 6.99 cm)	14/ctn
<b>6776TC</b>	6776TC	10-1/2" (26.67 cm) Black - w/Convuluted Foam	9-1/2" x 5-3/4" x 2-3/4", (24.13 x 14.61 x 6.99 cm)	14/ctn
<b>6775WF</b>	6775WF	10-1/2" (26.67 cm) Black - w/Convuluted Foam Lid and Diced Foam Base	9-1/2" x 5-3/4" x 2-3/4", (24.13 x 14.61 x 6.99 cm)	14/ctn
<b>6775TF</b>	6775TF	10-1/2" (26.67 cm) Translucent Clear	9-1/2" x 5-3/4" x 2-3/4", (24.13 x 14.61 x 6.99 cm)	14/ctn
<b>6775TD</b>	6775TD	10-1/2" (26.67 cm) Translucent Blue	9-1/2" x 5-3/4" x 2-3/4", (24.13 x 14.61 x 6.99 cm)	14/ctn
<b>6775TB</b> ®	6775TB	10-1/2" (26.67 cm) Black/ECO - w/Out Foam	9-1/2" x 5-3/4" x 2-3/4", (24.13 x 14.61 x 6.99 cm)	14/ctn
<b>6777TC</b>	6777TC	12.0" (30.48 cm) Black - w/Out Foam	11.0" x 7-1/4" x 3-1/4", (27.94 x 18.41 x 8.25 cm)	12/ctn
<b>6777TC</b>	6777TC	12.0" (30.48 cm) Black - w/Convuluted Foam	11.0" x 7-1/4" x 3-1/4", (27.94 x 18.41 x 8.25 cm)	12/ctn
<b>6777TC</b>	6777TC	12.0" (30.48 cm) Black - w/Convuluted Foam Lid and Diced Foam Base	11.0" x 7-1/4" x 3-1/4", (27.94 x 18.41 x 8.25 cm)	12/ctn
<b>6777TD</b>	6777TD	12.0" (30.48 cm) Translucent Clear - w/Out Foam	11.0" x 7-1/4" x 3-1/4", (27.94 x 18.41 x 8.25 cm)	12/ctn
<b>6777TB</b> ®	6777TB	12.0" (30.48 cm) Black/ECO - w/Out Foam	11.0" x 7-1/4" x 3-1/4", (27.94 x 18.41 x 8.25 cm)	12/ctn
<b>6780TC</b>	6780TC	14.0" (35.56 cm) Black - w/Out Foam	13-1/4" x 7-3/8" x 3.0", (33.66 x 18.73 x 7.62 cm)	14/ctn
<b>6781TC</b>	6781TC	14.0" (35.56 cm) Black - w/Convuluted Foam	13-1/4" x 7-3/8" x 3.0", (33.66 x 18.73 x 7.62 cm)	14/ctn
<b>6780XG</b>	6780XG	14.0" (35.56 cm) Black - w/Convuluted Foam Lid and Diced Foam Base	13-1/4" x 7-3/8" x 3.0", (33.66 x 18.73 x 7.62 cm)	14/ctn
<b>6780TN</b>	6780TN	14.0" (35.56 cm) Translucent Clear	13-1/4" x 7-3/8" x 3.0", (33.66 x 18.73 x 7.62 cm)	14/ctn
<b>6780TP</b>	6780TP	14.0" (35.56 cm) Translucent Blue	13-1/4" x 7-3/8" x 3.0", (33.66 x 18.73 x 7.62 cm)	14/ctn
<b>6780TB</b> ®	6780TB	14.0" (35.56 cm) Black/ECO - w/Out Foam	13-1/4" x 7-3/8" x 3.0", (33.66 x 18.73 x 7.62 cm)	14/ctn
<b>6785TC</b>	6785TC	17.0" (43.18 cm) Black - w/Out Foam	16-3/8" x 9-1/4" x 3-1/2", (41.59 x 23.50 x 8.89 cm)	6/ctn
<b>6785TE</b>	6785TE	17.0" (43.18 cm) Black - w/Convuluted Foam	16-3/8" x 9-1/4" x 3-1/2", (41.59 x 23.50 x 8.89 cm)	6/ctn
<b>6785UP</b>	6785UP	17.0" (43.18 cm) Black - w/Convuluted Foam Lid and Diced Foam Base	16-3/8" x 9-1/4" x 3-1/2", (41.59 x 23.50 x 8.89 cm)	6/ctn
<b>6785TI</b>	6785TI	17.0" (43.18 cm) Translucent Clear	16-3/8" x 9-1/4" x 3-1/2", (41.59 x 23.50 x 8.89 cm)	6/ctn
<b>6785TB</b> ®	6785TB	17.0" (43.18 cm) Black/ECO - w/Out Foam	16-3/8" x 9-1/4" x 3-1/2", (41.59 x 23.50 x 8.89 cm)	6/ctn

# Additional Options

## Tradesman™ and Merchant™ Cases

### Customization:

Customize your Tradesman or Merchant case with options that include engraving, printing, labeling, die-cut foam and the in-mold labeling process which is nearly indestructible and impervious to chemicals.



### Custom Options Enhance Interest:

Grab attention with attractive designs and colors that outperform your competitor's packaging. Private label any of our boxes to give your company the edge it deserve

### In-Mold Decorating:

Achieve high quality, multi-color graphic labeling. We guarantee straight, crisp, clear graphics impervious to most chemicals. *\*Injection or blow mold products.*



### Custom Foam:

Merchant™ and Tradesman™ cases offer the best solution when foam is the desired choice for protecting and merchandising your products.



Even the 7" Merchant Case can have a custom foam interior.



**NEW**

**7415GB**  
7415GB



**Shotshell Gear Box**

**NEW**

**7425GB**  
7425GB



**Shotshell Gear Box w/  
Removable Dividers**

**NEW**

**1250STP**  
1250STP



**Shotshell Storage Tray**

- Stackable / nesting
- Fits (50) shells of any 12 or 20 GA sizes



MODEL #	STOCK #	DESCRIPTION	DIMENSIONS (INSIDE: L x W x D)	PACKED
<b>7415GB</b>	7415GB	Black No Lift-Out Tray	9-5/8" x 7.0" x 4-1/4" (24.45 x 17.78 x 10.80 cm)	6/ctn
<b>7425GB</b>	7425GB	Black Removable Dividers	9-5/8" x 7.0" x 4-1/4" (24.45 x 17.78 x 10.80 cm)	6/ctn
<b>1250STP</b>	1250STP	Black	12.0" x 5-7/8" x 3.0" (30.48 x 14.92 x 7.62 cm)	6/ctn



# Gear Boxes

These Gear Boxes are perfect for Firearm Supplies, Medical Supplies, Safety Equipment, Auto Repair Kits, Test Equipment, Art Supplies, Maintenance Supplies and much more.

**Features:**

- Deep open interior
- Gasket in lid
- Lift-out tray
- Snap-open lid with storage
- Cam-over latch design
- Oversized handle & latch
- Tongue-and-groove design

**Benefits:**

- Accommodates large, tall parts & equipment
- Keeps content protected in harsh environments
- Provides added strength
- Helps keep dust and contaminants out
- Perfect for storing small parts
- Keeps everything organized & at your fingertips
- Secures contents in main compartment



All models include a 360° gasket in the lid which keeps contents dry and protected from some of the most extreme environments.



As an option, both sizes can be molded in Zerust® Corrosion Inhibitor creating an invisible barrier to protect metal parts from rust and tarnish. (See page 6)



**T1100**  
5415GB



**T1400**  
6415GB



**8415GB**  
8415GB

MODEL #	STOCK #	DESCRIPTION	DIMENSIONS (INSIDE: L x W x D)	PACKED
<b>T1100</b>	5415GB	Mini, Black with No Lift-Out Tray	6-7/8" x 3-1/2" x 5-1/2" (17.46 x 8.89 x 13.97 cm)	6/ctn
<b>T1400</b>	6415GB	Small, Black with No Lift-Out Tray	9-1/5" x 4-1/4" x 6.0" (23.37 x 10.80 x 15.24 cm)	6/ctn
<b>8415GB</b>	8415GB	HD, Black with No Lift-Out Tray	6-7/8" x 3-1/2" x 5-1/2" (17.46 x 8.89 x 13.97 cm)	4/ctn





All sizes available in custom colors.  
(See page 5 for details)



**T1408B**  
6430TB



**T1418**  
6917TB



MODEL #	STOCK #	DESCRIPTION	DIMENS. (INSIDE: L x W x D)	TRAY DIMENS. (L x W x D)	CLEARANCE UNDER TRAY (DEPTH)	PACKED
<b>T1408B</b>	6430TD	Medium, Black with Lift-Out Tray	13.0" x 6-3/4" x 7-1/4" (33.02 x 17.15 x 18.42 cm)	12-3/4" x 6-1/2" x 2.0" (32.39 x 16.51 x 5.08 cm)	5-1/4" (13.33 cm)	4/ctn
<b>T1418</b>	6917GB	Large, Black w/Lift-Out Tray w/2 Removable Dividers	16-1/2" x 10.0" x 10-1/2" (41.91 x 25.40 x 26.67 cm)	16.0" x 9-3/4" x 2-1/2" (40.64 x 24.76 x 6.35 cm)	7.0" (17.78 cm)	2/ctn

# Black Ribbon™

Flambeau offers a product line of water resistant cases available in six sizes! These extremely durable cases feature a metal front cam locking mechanical latch system and external rubber bumpers for impact absorption, skid resistance, and greater durability. Made of tough, impact-resistant ABS plastic, these cases are available with or without foam, as well as die-cut foam should you require more protection for your valuables. Black Ribbon cases are excellent for outdoor use in demanding environments and are ideal for storing and protecting cell phones, electronic devices, jewelry, small tools, components and more!



MODEL #	STOCK #	DESCRIPTION	DIMENS. (INSIDE: L x W x D)	PACKED	MODEL #	STOCK #	DESCRIPTION	DIMENS. (INSIDE: L x W x D)	PACKED
<b>6734PC</b>	6734PC	4-3/8" (11.11 cm) Black - w/Out Foam	3-7/8" x 2-3/8" x 1-3/8" (9.84 x 6.03 x 3.49 cm)	4/ctn	<b>6735PF</b>	6735PF	5.0" (12.70 cm) Black - w/Flat Foam Lid & Base	4-3/8" x 2-7/8" x 1-3/8" (11.11 x 7.30 x 3.49 cm)	4/ctn
<b>6735PC</b> (Not shown)	6735PC	5.0" (12.70 cm) Black - w/Out Foam	4-3/8" x 2-7/8" x 1-3/8" (11.11 x 7.30 x 3.49 cm)	4/ctn	<b>6736PF</b>	6736PF	6-1/4" (15.56 cm) Black - w/Flat Foam Lid & Base	5-7/8" x 2-3/4" x 1-1/2" (14.92 x 6.99 x 3.81 cm)	4/ctn
<b>6736PC</b>	6736PC	6-1/4" (15.56 cm) Black - w/Out Foam	5-7/8" x 2-3/4" x 1-1/2" (14.92 x 6.99 x 3.81 cm)	4/ctn	<b>6738PC</b>	6738PC	8-1/2" (21.59 cm) Black - w/Out Foam	8-1/2" x 5-1/4" x 2-1/4" (21.59 x 13.34 x 5.72 cm)	4/ctn
<b>6737PC</b>	6737PC	7-3/4" (19.69 cm) Black - w/Out Foam	7-1/8" x 3-5/8" x 1-11/16" (18.10 x 9.21 x 4.29 cm)	4/ctn	<b>6739PB</b>	6739PB	10-3/5" (26.92 cm) Black - w/Out Foam	10.0" x 8.0" x 2-1/2" (25.40 x 20.32 x 6.35 cm)	4/ctn

# Linesman Case

The Linesman Case is very unique yet versatile. This 43" long case is designed for multiple storage applications---long and deep enough to store and protect everything from fishing rods to small rifles, and everything in-between. The ergonomic offset handle helps balance the heaviest loads during transport.

**Features:**

- Deep 6" base
- (4) Locking points
- Ergonomic off-set handle
- Tough ABS latches
- Piano-style hinge construction
- Stackable



**7450AP** 7450AP



**7450BG** 7450BG

## 8 Pistol Linesman Case

Finally a case large enough to hold your firearm collection! Protected with foam, the pistols sit vertically along the 42 inch case with easy access to the grips. The flexible foam allows for any size pistol to fit nicely in each pre-cut slot. There's even enough room for an extra magazine next to each pistol.

MODEL #	STOCK #	DESCRIPTION	DIMENSIONS (L x W x D)	PACKED
<b>7450AP</b>	7450AP	Stock - No Foam	40.0" x 9-1/2" x 6.0" (101.63 x 24.05 x 15.24 cm)	1/ctn
<b>7450BG</b>	7450BG	8 - Pistol Foam	40.0" x 9-1/2" x 6.0" (101.63 x 24.05 x 15.24 cm)	1/ctn





**When You Need It Protected!**

## Infinity™ Case

With flair, style and professional presence, the Infinity is designed to give you a high level of protection with a modern look. It features a natural dust seal, double wall protection in the lid and base, is crush resistant and can withstand a 30 pound impact test. Two ABS cam-over latches are featured with each case size. Infinity cases are available in a variety of sizes and depths.

### Features:

- Integral or pin-hinge
- Locking hole
- Dual latch system
- Water-resistant
- Chemical-resistant
- Crush-resistant
- Stackable

Infinity 10 FH 4

Infinity 17 FW 6-1/2

Infinity 20 FQ 8-1/2

Infinity 12 FQ 2-1/2

Infinity 43 FZ 7

Infinity 14 FV 5

Infinity 12 FQ 4-1/2

Infinity 27 FZ 8-1/2

Infinity 14 FV 4

5" x 2"  
Name plate



Double Wall Protection



Infinity Locking Hole



Infinity Pin Hinge





### Infinity™ Case Customization:

The Infinity case lends itself to customization including engraving, printing, labeling, die-cut foam, custom colors and the in-mold labeling or decorating process.

- In-mold labeling or decorating process
- Engraving
- Printing
- Adhesive labels
- Die-cut foam
- Custom colors



Empty



Convoluted and Flat Foam



Convoluted and Diced Foam

#### Case Options:

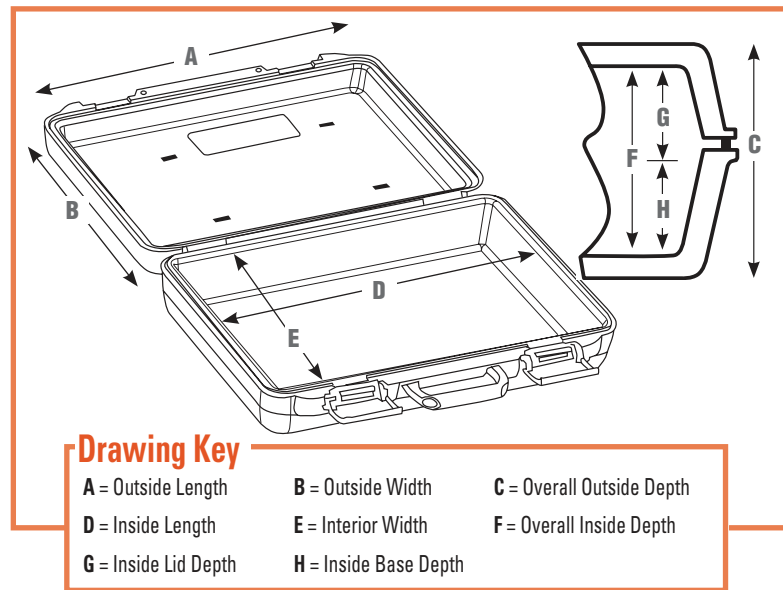
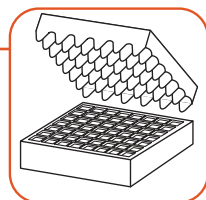
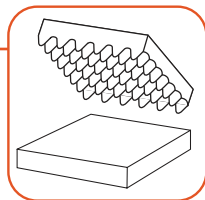

See ordering selection and information on next page



# Infinity® Case

\* Express Service (E Symbol) items are for quantities 500 and less. For greater quantities call customer service: 1-800-344-5716.

MODEL #	STOCK #	DESCRIPTION	DIMENS. (INSIDE: L x W x D) (D X E X F)	INSIDE DEPTH (INSIDE: LID, BASE)	DIMENS. (OUTSIDE: L x W x D) (A x B x C)	STANDARD: HANDLE / LATCH
50190 <b>E</b>	50190	<b>Infinity 10 FH4</b> Foam Available	8-1/4" x 5-7/16" x 3-5/16" (20.96 x 13.81 x 8.41)	Lid: 1-5/16" (3.33 cm) Base: 1-15/16" (4.92 cm)	10-1/8" x 8-1/8"x 4.0" (25.72 x 20.64 x 10.16 cm)	H052 / L089
50250 <b>E</b>	50250	<b>Infinity 12 FQ2-1/2</b> Foam Available	9-1/2" x 6-5/8" x 1-3/4" (24.13 x 16.83 x 4.45)	Lid: 3/8" (0.95 cm) Base: 1-3/8" (3.49 cm)	12.0" x 9.0"x 2-1/2" (30.48 x 22.864 x 6.35 cm)	NONE / L089
50290 <b>E</b>	50290	<b>Infinity 12 FQ4-1/2</b> Foam Available	9-1/2" x 6-5/8" x 3-3/16" (24.13 x 16.83 x 4.45)	Lid: 2-7/16" (6.19 cm) Base: 2-3/8" (6.03 cm)	12.0" x 9.0"x 4-1/2" (30.48 x 22.86 x 11.43 cm)	H052 / L089
50330 <b>E</b>	50330	<b>Infinity 14 FV4</b> Foam Available	11-1/2" x 8-1/2" x 3-3/16" (29.21 x 21.59 x 8.10)	Lid: 1-3/8" (3.49 cm) Base: 1-13/16" (4.60 cm)	14.0" x 10-1/2"x 4.0" (35.56 x 26.67 x 10.16 cm)	H052 / L089
50350 <b>E</b>	50350	<b>Infinity 14 FV5</b> Foam, Integral Hinge Avail.	11-1/2" x 8-1/2" x 4-1/4" (29.21 x 21.59 x 10.80)	Lid: 1-7/8" (4.76 cm) Base: 2-3/8" (6.03 cm)	14.0" x 10-1/2"x 5.0" (35.56 x 26.67 x 12.70 cm)	H052 / L089
50351 <b>E</b>	50351	<b>Infinity 14 FV5</b> Foam, Pin Hinge Avail.	11-1/2" x 8-1/2" x 4-1/4" (29.21 x 21.59 x 10.80)	Lid: 1-7/8" (4.76 cm) Base: 2-3/8" (6.03 cm)	14.0" x 10-1/2"x 5.0" (35.56 x 26.67 x 12.70 cm)	H052 / L089
50380 <b>E</b>	50380	<b>Infinity 14 FV6-1/2</b> Foam Available	11.0" x 7-11/16" x 5-3/4" (27.94 x 19.53 x 14.61)	Lid: 2-1/4" (5.41 cm) Base: 3-1/2" (8.90 cm)	14.0" x 11.0"x 7.0" (35.60 x 28.0 x 17.80 cm)	H023OM / L089
50410 <b>E</b>	50410	<b>Infinity 17 FW4-1/2</b> Foam Available	14-3/8" x 10.0" x 3-7/16" (36.51 x 25.40 x 8.73)	Lid: 1-1/4" (3.18 cm) Base: 2-3/16" (5.56 cm)	17.0" x 14-1/2 "x 4-1/2" (43.18 x 36.83 x 11.43 cm)	H023OM / L085
50430 <b>E</b>	50430	<b>Infinity 17 FW6-1/2</b> Foam Available	14-3/8" x 10.0" x 5-9/16" (36.51 x 25.40 x 14.13)	Lid: 2-5/16" (5.87 cm) Base: 3-1/4" (8.26 cm)	17.0" x 14-1/2 "x 6-1/2" (43.18 x 36.83 x 16.51 cm)	H023OM / L085
50470 <b>E</b>	50470	<b>Infinity 20 FX5-1/2</b> Foam Available	17-3/4" x 12-5/8" x 4-1/16" (45.09 x 32.07 x 11.75)	Lid: 1-13/16" (4.60 cm) Base: 3.0" (7.62 cm)	20.0" x 15.0 "x 5-1/2" (50.80 x 38.10 x 13.97 cm)	H023OM / L095
50500 <b>E</b>	50500	<b>Infinity 20 FX8-1/2</b> Foam Available	17-3/4" x 12-5/8" x 7-1/2" (45.09 x 32.07 x 19.05)	Lid: 3-1/4" (8.26 cm) Base: 4-1/4" (10.80 cm)	20.0" x 15.0 "x 8-1/2" (50.80 x 38.10 x 21.59 cm)	H023OM / L095
50817 <b>E</b>	50817	<b>Infinity 27 FZ8-1/2</b> Foam Available	24-15/16" x 14-3/16" x 7-1/2" (63.33 x 36.03 x 19.05)	Lid: 1-1/2" (3.81 cm) Base: 6.0" (15.24 cm)	27-3/8" x 18.0 "x 8-1/2" (69.53 x 45.72 x 21.59 cm)	H074 / L115
50845 <b>E</b>	50845	<b>Infinity 43 FZ7</b> Foam Available	40-5/8" x 14-7/16" x 6.0" (103.18 x 36.67 x 15.24)	Lid: 1-1/2" (3.81 cm) Base: 4-1/2" (11.43 cm)	43.0" x 18-15/16 "x 7.0" (109.22 x 46.51 x 17.78 cm)	H074 / L116

## The "P" Series, (the "Pin-Hinge" Case)

The "P" series case is a Flambeau® original and has a proven track record in most industries and applications. This is a "pin-hinge" style high-density polyethylene (HDPE) blow mold case. The routed

base option is designed to accommodate our standard solid foam or diced foam set and is available in a variety of sizes and depths *(see pages 28 - 29)*

### Features:

- Heavy-duty latches
- Double wall protection
- Impervious to most chemicals
- Crush-resistant
- Stackable



*See ordering selection and information on pages 28 -29*

# Additional Features and Options

## The "P" Series Cases

The "P" Series is easily customized through engraving, printing, labeling, custom colors, die-cut foam, molded interiors and in-mold decorating (molded into the case) which is nearly indestructible.

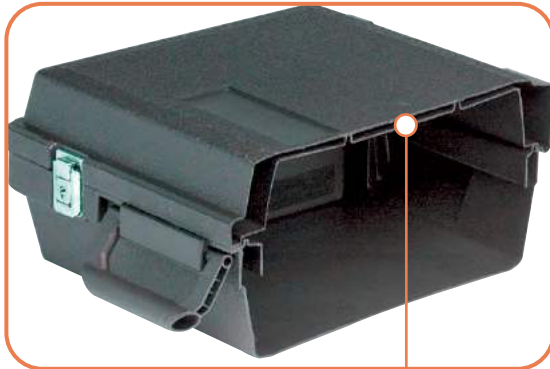

Double Wall Protection

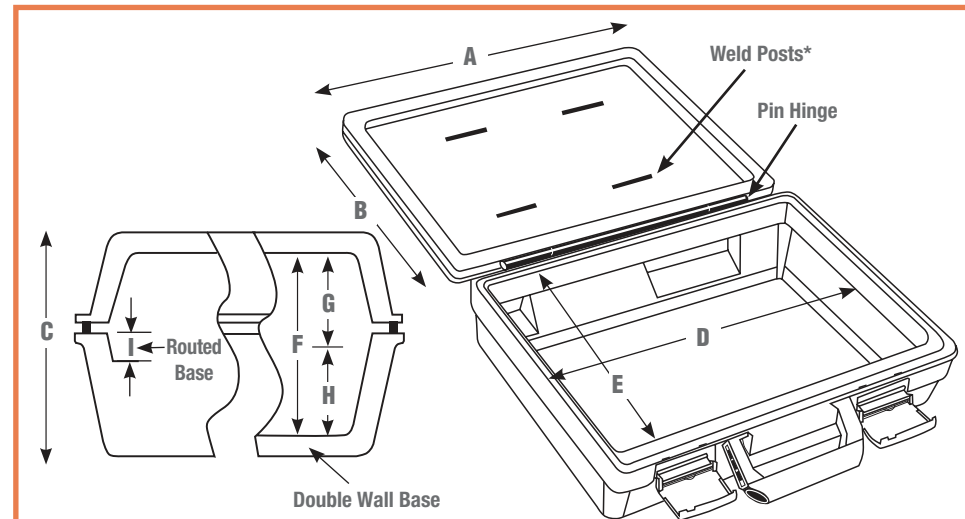





### Drawing Key

- |                      |                       |                           |
|----------------------|-----------------------|---------------------------|
| A = Outside Length   | B = Outside Width     | C = Overall Outside Depth |
| D = Inside Length    | E = Interior Width    | F = Overall Inside Depth  |
| G = Inside Lid Depth | H = Inside Base Depth | I = Routed Depth          |



## The "P" Series: The Pin-Hinge Case

MODEL #	STOCK #	DESCRIPTION	DIMENS. (INSIDE: L x W x D) (D X E X F)	INSIDE DEPTH (INSIDE: LID, BASE)	DIMENS. (OUTSIDE: L x W x D) (A x B x C)	STANDARD: HANDLE / LATCH	ROUTED DEPTH = I
<b>18673</b>	18673	PB 1-5/8 Foam Available	6-13/16" x 3-3/16" x 1-5/16" (17.30 x 8.10 x 3.33 cm)	Lid: 1/8" (0.32 cm) Base: 1-3/16" (3.02 cm)	7-1/2" x 4-1/2" x 1-5/8" (19.05 x 11.43 x 4.13 cm)	None / L089	1/4" (0.64 cm)
<b>17873</b>	17873	PC 3-1/8 Foam Available	7-9/16" x 5-7/8" x 2-13/16" (19.21 x 14.92 x 7.14 cm)	Lid: 5/8" (1.59 cm) Base: 2-3/16" (5.56 cm)	8-1/2" x 7-13/16" x 3-1/8" (21.59 x 19.84 x 7.94 cm)	H001 / L089	7/16" (1.11 cm)
<b>50032</b> 	50032	PC 3-9/16, Foam Avail., Label Area 4-7/8 x 1-7/8 (12.38 x 4.76)	7-9/16" x 5-7/8" x 3-1/4" (19.21 x 14.92 x 8.26 cm)	Lid: 5/8" (1.59 cm) Base: 2-5/8" (6.67 cm)	8-1/2" x 7-13/16" x 3-9/16" (21.59 x 19.84 x 9.05 cm)	H001 / L089	7/16" (1.11 cm)
<b>15865</b>	15865	PC 3-9/16, Label Area 3-1/4 x 1-1/2 (8.26 x 3.81)	7-9/16" x 5-7/8" x 3-1/4" (19.21 x 14.92 x 8.26 cm)	Lid: 5/8" (1.59 cm) Base: 2-5/8" (6.67 cm)	8-1/2" x 7-13/16" x 3-9/16" (21.59 x 19.84 x 9.05 cm)	H001 / L089	7/16" (1.11 cm)
<b>16070</b>	16070	PF 1-3/4	8-5/8" x 4.0" x 1-7/16" (21.91 x 10.16 x 3.65 cm)	Lid: 5/8" (1.59 cm) Base: 13/16" (2.06 cm)	9-1/2" x 5-3/4" x 1-3/4" (24.13 x 14.61 x 4.45 cm)	NONE / L089	7/16" (1.11 cm)
<b>16716</b>	16716	PF 3-1/8	8-5/8" x 4.0" x 2-13/16" (21.91 x 10.16 x 7.14 cm)	Lid: 5/8" (1.59 cm) Base: 3-3/16" (8.10 cm)	9-1/2" x 5-3/4" x 3-1/8" (24.13 x 14.61 x 7.94 cm)	H001 / L089	7/16" (1.11 cm)
<b>50048</b> 	50048	PH 3-1/8 Foam Available	9-1/8" x 6-1/2" x 2-13/16" (23.18 x 16.51 x 7.14 cm)	Lid: 5/8" (1.59 cm) Base: 2-3/16" (5.56 cm)	10.0" x 8-5/16" x 3-1/8" (25.40 x 21.11 x 7.94 cm)	H001 / L089	7/16" (1.11 cm)
<b>18964</b>	18964	PH 3-7/16	9-1/8" x 6-1/2" x 3-1/8" (23.18 x 16.51 x 7.94 cm)	Lid: 15/16" (2.38 cm) Base: 2-3/16" (5.56 cm)	10.0" x 8-5/16" x 3-7/16" (25.40 x 21.11 x 8.73 cm)	H001 / L089	7/16" (1.11 cm)
<b>17383</b>	17383	PH 3-9/16	9-1/8" x 6-1/2" x 3-1/4" (23.18 x 16.51 x 8.26 cm)	Lid: 5/8" (1.59 cm) Base: 2-5/8" (6.67 cm)	10.0" x 8-5/16" x 3-9/16" (25.40 x 21.11 x 9.05 cm)	H001 / L089	7/16" (1.11 cm)
<b>18290</b>	18290	PH 3-7/8	9-1/8" x 6-1/2" x 3-9/16" (23.18 x 16.51 x 9.05 cm)	Lid: 15/16" (2.38 cm) Base: 2-5/8" (6.67 cm)	10.0" x 8-5/16" x 3-7/8" (25.40 x 21.11 x 9.84 cm)	H001 / L089	7/16" (1.11 cm)
<b>16615</b>	16615	PQ 2-3/8	11-3/8" x 7.0" x 2-1/16" (28.89 x 17.78 x 5.24 cm)	Lid: 15/16" (2.38 cm) Base: 1-1/8" (2.86 cm)	12-1/4" x 8-13/16" x 2-3/8" (31.12 x 22.38 x 6.03 cm)	NONE / L089	7/16" (1.11 cm)
<b>18924</b>	18924	PQ 3-7/16	11-3/8" x 7.0" x 3-1/8" (28.89 x 17.78 x 7.94 cm)	Lid: 15/16" (2.38 cm) Base: 2-3/16" (5.56 cm)	12-1/4" x 8-13/16" x 3-7/16" (31.12 x 22.38 x 8.73 cm)	H052 / L089	7/16" (1.11 cm)
<b>50025</b> 	50025	PQ 3-7/8 Foam Available	11-3/8" x 7.0" x 3-9/16" (28.89 x 17.78 x 9.05 cm)	Lid: 15/16" (2.38 cm) Base: 2-5/8" (6.67 cm)	12-1/4" x 8-13/16" x 3-7/8" (31.12 x 22.38 x 9.84 cm)	H052 / L089	7/16" (1.11 cm)
<b>15658</b>	15658	PV 3-1/8	12-11/16" x 8-15/16" x 2-13/16" (32.23 x 22.70 x 7.14 cm)	Lid: 5/8" (1.59 cm) Base: 2-3/16" (5.56 cm)	13-1/2" x 10-13/16" x 3-1/8" (34.29 x 27.46 x 7.94 cm)	H052 / L089	7/16" (1.11 cm)
<b>16952</b>	16952	PV 3-7/16	12-11/16" x 8-15/16" x 3-1/8" (32.23 x 22.70 x 7.94 cm)	Lid: 15/16" (2.38 cm) Base: 2-3/16" (5.56 cm)	13-1/2" x 10-13/16" x 3-7/16" (34.29 x 27.46 x 8.73 cm)	H052 / L089	7/16" (1.11 cm)
<b>16541</b>	16541	PV 3-11/16	12-11/16" x 8-15/16" x 3-3/8" (32.23 x 22.70 x 8.57 cm)	Lid: 5/8" (1.59 cm) Base: 2-3/4" (6.99 cm)	13-1/2" x 10-13/16" x 3-11/16" (34.29 x 27.46 x 9.37 cm)	H052 / L089	7/16" (1.11 cm)
<b>50024</b> 	50024	PV 4 Foam Available	12-11/16" x 8-15/16" x 3-11/16" (32.23 x 22.70 x 9.37 cm)	Lid: 15/16" (2.38 cm) Base: 2-3/4" (6.99 cm)	13-1/2" x 10-13/16" x 4.0" (34.29 x 27.46 x 10.16 cm)	H052 / L089	7/16" (1.11 cm)

# The "P" Series Continued

\* Express Service (E Symbol) items are for quantities 500 and less. For greater quantities call customer service: 1-800-344-5716.

MODEL #	STOCK #	DESCRIPTION	DIMENS. (INSIDE: L x W x D) (D X E X F)	INSIDE DEPTH (INSIDE: LID, BASE)	DIMENS. (OUTSIDE: L x W x D) (A x B x C)	STANDARD: HANDLE / LATCH	ROUTED DEPTH = I
<b>50026</b> <span style="border: 1px solid red; padding: 0 2px;">E</span>	50026	PV 5-1/8 Foam Available	12-11/16" x 8-15/16" x 4-3/4" (32.23 x 22.70 x 12.07 cm)	Lid: 1-1/2" (3.81 cm) Base: 3-1/4" (8.26 cm)	13-1/2" x 10-13/16" x 5-1/8" (34.29 x 27.46 x 13.02 cm)	H052 / L089	7/16" (1.11 cm)
<b>16965</b>	16965	PV 6-1/8 Foam Available	12-11/16" x 8-15/16" x 5-5/8" (32.23 x 22.70 x 14.29 cm)	Lid: 1-7/8" (4.76 cm) Base: 3-3/4" (9.53 cm)	13-1/2" x 10-13/16" x 6-1/8" (34.29 x 27.46 x 15.56 cm)	H052 / L089	7/16" (1.11 cm)
<b>50030</b> <span style="border: 1px solid red; padding: 0 2px;">E</span>	50030	PW 4 Foam Available	14.0" x 10-3/4" x 3-1/2" (35.56 x 27.31 x 8.89 cm)	Lid: 5/8" (1.59 cm) Base: 2-7/8" (7.30 cm)	15-1/2" x 13-5/16" x 4.0" (39.37 x 33.81 x 10.16 cm)	H023OM / L085	1-1/4" (3.18 cm)
<b>11585</b>	11585	PW 4-3/4	14.0" x 10-3/4" x 4-1/4" (35.56 x 27.31 x 10.80 cm)	Lid: 1-3/8" (3.49 cm) Base: 2-7/8" (7.30 cm)	15-1/2" x 13-5/16" x 4-3/4" (39.37 x 33.81 x 12.07 cm)	H023OM / L085	1-1/4" (3.18 cm)
<b>11598</b>	11598	PW 4-3/4 Double Wall Base	14.0" x 10-3/4" x 4.0" (35.56 x 27.31 x 10.16 cm)	Lid: 1-3/8" (3.49 cm) Base: 2-5/8" (6.67 cm)	15-1/2" x 13-5/16" x 4-3/4" (39.37 x 33.81 x 12.07 cm)	H023OM / L085	1-1/4" (3.18 cm)
<b>11664</b>	11664	PW 5-1/2	14.0" x 10-3/4" x 5.0" (35.56 x 27.31 x 12.70 cm)	Lid: 2-1/8" (5.40 cm) Base: 2-7/8" (7.30 cm)	15-1/2" x 13-5/16" x 5-1/2" (39.37 x 33.81 x 13.97 cm)	H023OM / L085	1-1/4" (3.18 cm)
<b>50053</b> <span style="border: 1px solid red; padding: 0 2px;">E</span>	50053	PW 6-1/4 Foam Available	14.0" x 10-3/4" x 5-3/4" (35.56 x 27.31 x 14.61 cm)	Lid: 2-1/8" (5.40 cm) Base: 3-5/8" (9.21 cm)	15-1/2" x 13-5/16" x 6-1/4" (39.37 x 33.81 x 15.88 cm)	H023OM / L026	1-1/4" (3.18 cm)
<b>11588</b>	11588	PW 6-1/4	14.0" x 10-3/4" x 5-5/8" (35.56 x 27.31 x 14.29 cm)	Lid: 2-3/4" (6.98 cm) Base: 2-7/8" (7.30 cm)	15-1/2" x 13-5/16" x 6-1/4" (39.37 x 33.81 x 15.88 cm)	H023OM / L085	1-1/4" (3.18 cm)
<b>12090</b>	12090	PX 3-1/2	17.0" x 13.0" x 3.0" (43.18 x 33.02 x 7.62 cm)	Lid: 1-3/8" (3.49 cm) Base: 1-5/8" (4.13 cm)	18-1/2" x 15-9/16" x 3-1/2" (46.99 x 39.53 x 8.89 cm)	Integral / L037	15/16" (2.38 cm)
<b>50050</b> <span style="border: 1px solid red; padding: 0 2px;">E</span>	50050	PX 5	17.0" x 13.0" x 4-1/2" (43.18 x 33.02 x 11.43 cm)	Lid: 1-3/8" (3.49 cm) Base: 3-1/8" (7.94 cm)	18-1/2" x 15-9/16" x 5.0" (46.99 x 39.53 x 12.70 cm)	H023OM / L026	15/16" (2.38 cm)
<b>12097</b>	12097	PX 6-1/4	17.0" x 13.0" x 5-5/8" (43.18 x 33.02 x 14.29 cm)	Lid: 1-3/4" (4.45 cm) Base: 3-7/8" (9.84 cm)	18-1/2" x 15-9/16" x 6-1/4" (46.99 x 39.53 x 15.88 cm)	Integral / L037	15/16" (2.38 cm)
<b>50051</b> <span style="border: 1px solid red; padding: 0 2px;">E</span>	50051	PX 8	17.0" x 13.0" x 7-3/8" (43.18 x 33.02 x 18.73 cm)	Lid: 3-1/2" (8.89 cm) Base: 3-7/8" (9.84 cm)	18-1/2" x 15-9/16" x 8.0" (46.99 x 39.53 x 20.32 cm)	H023OM / L026	15/16" (2.38 cm)
<b>12023</b>	12023	PX 8	17.0" x 13.0" x 7-3/8" (43.18 x 33.02 x 18.73 cm)	Lid: 3-1/2" (8.89 cm) Base: 3-7/8" (9.84 cm)	18-1/2" x 15-9/16" x 8.0" (46.99 x 39.53 x 20.32 cm)	H023OM / L085	15/16" (2.38 cm)
<b>18925</b>	18925	PX 8	17.0" x 13.0" x 7.0" (43.18 x 33.02 x 17.78 cm)	Lid: 3-1/2" (8.89 cm) Base: 3-1/2" (8.89 cm)	18-1/2" x 15-9/16" x 8.0" (46.99 x 39.53 x 20.32 cm)	H023OM / L085	15/16" (2.38 cm)
<b>50045</b> <span style="border: 1px solid red; padding: 0 2px;">E</span>	50045	PZ 4-1/2, Foam Avail. Integral Handle Option	24-1/2" x 13.0" x 3-5/8" (62.23 x 33.02 x 9.21 cm)	Lid: 7/8" (2.22 cm) Base: 2-3/4" (6.99 cm)	26.0" x 15-9/16" x 4-1/2" (66.04 x 39.53 x 11.43 cm)	H023OM / L095	1-1/8" (2.86 cm)
<b>50088</b> <span style="border: 1px solid red; padding: 0 2px;">E</span>	12414	PZ 8, Foam Avail. Integral Handle Option	24-1/2" x 13.0" x 7-3/8" (62.23 x 33.02 x 18.73 cm)	Lid: 3-1/2" (8.89 cm) Base: 3-7/8" (9.84 cm)	26.0" x 15-9/16" x 8.0" (66.04 x 39.53 x 20.32 cm)	H023OM / L095	1-1/8" (2.86 cm)
<b>50415</b> <span style="border: 1px solid red; padding: 0 2px;">E</span>	12415	PZ 9	24-1/2" x 13.0" x 8-3/8" (62.23 x 33.02 x 21.27 cm)	Lid: 3-1/2" (8.89 cm) Base: 4-7/8" (12.38 cm)	26.0" x 15-9/16" x 9.0" (66.04 x 39.53 x 22.86 cm)	H023OM / L095	1-1/8" (2.86 cm)

# The Defender®



The combination of high-density polyethylene and double wall construction offers increased product protection. Can be customized through in-mold permanent label, logo engraving, custom colors, foam or molded interior.

Telescoping Handle



### Case Options:



Pressure Valve Release

Wheel Assembly

## The Defender®...Just In Case!





**Defender 12**

**Defender 18**

**Defender 23**

**Defender 26**

**Defender 17**



**Features:**



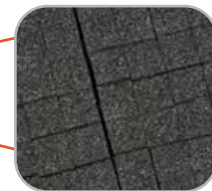











- ABS latches and steel pin-hinge construction
- Rear feet detail (offers stability for upright display)
- Exterior banding strap feature (allows case to be used as a shipping container)
- Water-resistant
- Chemical-resistant
- Crush-resistant
- Stackable



Diced Foam Option

# The Defender®

\* Express Service (E Symbol) items are for quantities 500 and less. For greater quantities call customer service: 1-800-344-5716.

MODEL #	STOCK #	DESCRIPTION	DIMENS (INSIDE: L x W x D)	DIMENS (OUTSIDE: L x W x D)
50641 	50641	<b>Defender 12 (DQ 6)</b>	12.0" x 9.0" x 5.0" (30.48 x 22.86 x 12.70)	15-15/16" x 13-1/4" x 6-7/16" (40.48 x 33.65 x 16.35 cm)
50641F 	50641F	<b>Defender 12 (DQ 6)</b> w/Diced Foam	12.0" x 9.0" x 5.0" (30.48 x 22.86 x 12.70)	15-15/16" x 13-1/4" x 6-7/16" (40.48 x 33.65 x 16.35 cm)
50514 	50514	<b>Defender 17 (DW 6)</b>	15.0" x 12.0" x 5.0" (38.10 x 30.48 x 12.70)	18-1/2" x 15.0" x 6-3/16" (21.59 x 38.10 x 15.72 cm)
50514F 	50514F	<b>Defender 17 (DW 6)</b> w/Diced Foam	15.0" x 12.0" x 5.0" (38.10 x 30.48 x 12.70)	18-1/2" x 15.0" x 6-3/16" (21.59 x 38.10 x 15.72 cm)
50642 	50642	<b>Defender 18 (DX 7)</b>	15-1/2" x 10-1/4" x 6.0" (39.37 x 26.03 x 15.24)	20-3/4" x 15-3/4" x 7-5/16" (52.70 x 40.0 x 18.57 cm)
50642F 	50642F	<b>Defender 18 (DX 7)</b> w/Diced Foam	15-1/2" x 10-1/4" x 6.0" (39.37 x 26.03 x 15.24)	20-3/4" x 15-3/4" x 7-5/16" (52.70 x 40.0 x 18.57 cm)
50720 	50720	<b>Defender 23 (DY 9)</b>	19-1/2" x 15.0" x 7-5/16" (49.53 x 38.10 x 18.57)	25-1/4" x 21.0" x 9-3/16" (64.13 x 53.34 x 23.34 cm)
50720F 	50720F	<b>Defender 23 (DY 9)</b> w/Diced Foam	19-1/2" x 15.0" x 7-5/16" (49.53 x 38.10 x 18.57)	25-1/4" x 21.0" x 9-3/16" (64.13 x 53.34 x 23.34 cm)
50720W 	50720W	<b>Defender 23 (DY 9)</b> w/Handle and Wheel Assembly	19-1/2" x 15.0" x 7-5/16" (49.53 x 38.10 x 18.57)	25-1/4" x 21.0" x 9-3/16" (64.13 x 53.34 x 23.34 cm)
50720WF 	50720WF	<b>Defender 23 (DY 9)</b> w/Diced Foam, Handle and Wheel Assembly	19-1/2" x 15.0" x 7-5/16" (49.53 x 38.10 x 18.57)	25-1/4" x 21.0" x 9-3/16" (64.13 x 53.34 x 23.34 cm)
50721 	50721	<b>Defender 26 (DZ 9)</b>	22-3/4" x 17-3/4" x 8.0" (57.78 x 44.04 x 20.32)	28-3/4" x 24.0" x 9-5/16" (73.02 x 60.96 x 23.65 cm)
50721F 	50721F	<b>Defender 26 (DZ 9)</b> w/Diced Foam	22-3/4" x 17-3/4" x 8.0" (57.78 x 44.04 x 20.32)	28-3/4" x 24.0" x 9-5/16" (73.02 x 60.96 x 23.65 cm)
50721W 	50721W	<b>Defender 26 (DZ 9)</b> w/Handle and Wheel Assembly	22-3/4" x 17-3/4" x 8.0" (57.78 x 44.04 x 20.32)	28-3/4" x 24.0" x 9-5/16" (73.02 x 60.96 x 23.65 cm)
50721WF 	50721WF	<b>Defender 26 (DZ 9)</b> w/Diced Foam, Handle and Wheel Assembly	22-3/4" x 17-3/4" x 8.0" (57.78 x 44.04 x 20.32)	28-3/4" x 24.0" x 9-5/16" (73.02 x 60.96 x 23.65 cm)

# The Aegis Line

The Aegis family of blow mold cases is Flambeau's latest introduction of all integral handle cases. These cases are built tough with double wall protection, steel pin-hinge assembly and multiple latch options. The Aegis line can be customized with engraved logo plate, custom molded interiors, foam inserts and other colors than black, if required.

A Case You Can Rely On!





# The Aegis Line



51000  
51000  
**Aegis 7**



51200  
51200  
**Aegis 12**

Shown with an optional custom interior



51250  
51250  
**Aegis 13**



51400  
51400  
**Aegis 15**



All Aegis Cases stocked with open core interiors



Customize All Aegis Cases with your name/company here



**51550**  
51550

**Aegis 22**



**51700**  
51700

**Aegis 23**

MODEL #	STOCK #	DESCRIPTION	DIMENSIONS (INSIDE: L x W x D)	DIMENSIONS (OUTSIDE: L x W x D)	PACKED
<b>51000</b>	51000	<b>Aegis 7</b> 1 Locking Point	6-2/5" x 3-1/2" x 1-3/4" (16.15 x 9.04 x 4.37 cm)	7-3/5" x 5-1/4" x 2-1/2" (19.38 x 13.39 x 6.35 cm)	105/ctn
<b>51200</b>	51200	<b>Aegis 12</b> No Locking Points	10-1/3" x 7-7/8" x 2-3/4" (26.19 x 19.91 x 5.74 cm)	11-3/4" x 10-2/5" x 2-7/8" (29.85 x 26.39 x 7.29 cm)	10/ctn
<b>51250</b>	51250	<b>Aegis 13</b> 2 Locking Points	12-1/8" x 6-3/5" x 2-1/2" (30.68 x 16.71 x 6.35 cm)	14-1/16" x 10.0" x 3-2/5" (35.71 x 25.43 x 8.66 cm)	30/ctn
<b>51400</b>	51400	<b>Aegis 15</b> 2 Locking Points	13-1/2" x 12.0" x 3-1/8" (34.14 x 30.23 x 7.82 cm)	16.0" x 15-1/2" x 4-1/3" (40.49 x 39.50 x 10.95 cm)	12/ctn
<b>51550</b>	51550	<b>Aegis 22</b> 2 Locking Points	19-3/5" x 15-1/3" x 4-2/5" (49.68 x 39.0 x 11.13 cm)	22-1/2" x 11.0" x 3-1/2" (57.15 x 27.94 x 8.89 cm)	4/ctn
<b>51700</b>	51700	<b>Aegis 23</b> 2 Locking Points	20.0" x 7-7/8" x 2-3/5" (50.62 x 19.84 x 6.71 cm)	22-1/2" x 19-3/5" x 5-3/5" (56.90 x 49.71 x 14.12 cm)	13/ctn
<b>51900</b>	51900	<b>Aegis 29</b> 2 Locking Points, Optional 2 Additional Latches	25.0" x 13-1/2" x 12-4/5" (63.5 x 34.29 x 32.39 cm)	29.0" x 21-1/8" x 13-3/4" (73.66 x 53.57 x 34.93 cm)	1/ctn



One of the largest blow mold cases in the market today!  
(Shown holding respirator equipment)

**51900**  
51900

**Aegis 29**

# Airmold® R-Series Case



The “R” series case features an integral hinge and latch system. This simple and reliable blow mold case is our most economical case offering. Constructed from high-density polyethylene (HDPE), this case is tough enough for almost any challenge. Available as a double wall case or with a routed base to accommodate foam, this case offers maximum protection. A broad range of sizes and depths are available.

**Features:**

- Integral hinge and latch
- Crush-resistant
- Options: double wall protection or routed base for foam insert

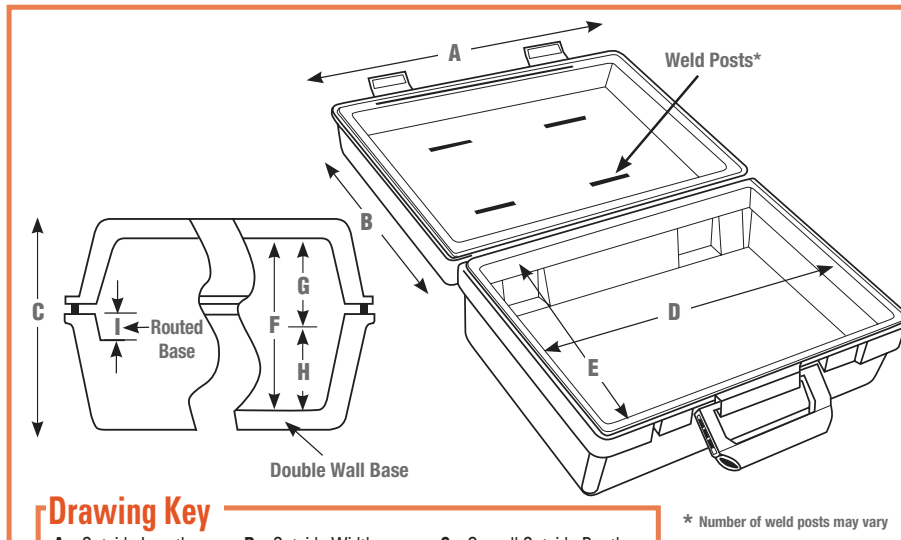

**Drawing Key**

A = Outside Length	B = Outside Width	C = Overall Outside Depth
D = Inside Length	E = Interior Width	F = Overall Inside Depth
G = Inside Lid Depth	H = Inside Base Depth	I = Routed Depth

\* Number of weld posts may vary

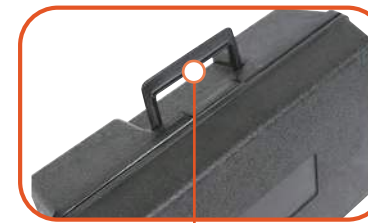



# The Airmold® R-Series

**\* Please Note: The Airmold Series is production-run only, no stock. See ordering selection and information on pages (37 - 39)**

MODEL #	STOCK #	DESCRIPTION	DIMENS. (INSIDE: L x W x D) (D X E X F)	INSIDE DEPTH (INSIDE: LID, BASE)	DIMENS. (OUTSIDE: L x W x D) (A x B x C)	STANDARD: HANDLE / LATCH	ROUTED DEPTH = I
<b>2504</b> Ⓢ	2504	RA 2-1/16	6-5/8" x 4-3/4" x 1-3/4" (16.83 x 12.07 x 4.45 cm)	Lid: 5/8" (1.59 cm) Base: 1-1/8" (2.86 cm)	7-1/2" x 5-3/4" x 2-1/16" (19.05 x 14.61 x 5.24 cm)	None / Integral	7/16" (1.11 cm)
<b>9431</b> Ⓢ	9431	RA 2-5/8	6-5/8" x 4-3/4" x 2-5/16" (16.83 x 12.07 x 5.87 cm)	Lid: 15/16" (2.38 cm) Base: 1-3/8" (3.49 cm)	7-1/2" x 5-3/4" x 2-5/8" (19.05 x 14.61 x 6.67 cm)	None / Integral	7/16" (1.11 cm)
<b>2505</b> Ⓢ	2505	RA 3-7/16	6-5/8" x 4-3/4" x 3-1/8" (16.83 x 12.07 x 7.94 cm)	Lid: 1.0" (2.54 cm) Base: 2-3/16" (5.56 cm)	7-1/2" x 5-3/4" x 3-7/16" (19.05 x 14.61 x 8.73 cm)	None / Integral	7/16" (1.11 cm)
<b>9411</b> Ⓢ	9411	RB 1-1/4	6-13/16" x 3-3/16" x 15/16" (17.30 x 8.10 x 2.38 cm)	Lid: 1/8" (0.32 cm) Base: 13/16" (2.06 cm)	7-1/2" x 4.0" x 1-1/4" (19.05 x 10.16 x 3.18 cm)	None / Integral	1/4" (0.64 cm)
<b>9512</b> Ⓢ	9512	RB 1-5/8	6-13/16" x 3-3/16" x 1-5/16" (17.30 x 8.10 x 3.33 cm)	Lid: 1/8" (0.32 cm) Base: 1-3/16" (3.02 cm)	7-1/2" x 4.0" x 1-5/8" (19.05 x 10.16 x 1.59 cm)	None / Integral	1/4" (0.64 cm)
<b>9513</b> Ⓢ	9513	RB 1-5/8	6-13/16" x 3-3/16" x 1-5/16" (17.30 x 8.10 x 3.33 cm)	Lid: 1/2" (1.27 cm) Base: 13/16" (2.06 cm)	7-1/2" x 4.0" x 1-5/8" (19.05 x 10.16 x 1.59 cm)	None / Integral	1/4" (0.64 cm)
<b>9514</b> Ⓢ	9514	RB 2	6-13/16" x 3-3/16" x 1-11/16" (17.30 x 8.10 x 4.29 cm)	Lid: 1/2" (1.27 cm) Base: 1-3/16" (3.02 cm)	7-1/2" x 4.0" x 2.0" (19.05 x 10.16 x 5.08 cm)	None / Integral	1/4" (0.64 cm)
<b>9515</b> Ⓢ	9515	RB 2	6-13/16" x 3-3/16" x 1-11/16" (17.30 x 8.10 x 4.29 cm)	Lid: 7/8" (2.22 cm) Base: 13/16" (2.06 cm)	7-1/2" x 4.0" x 2.0" (19.05 x 10.16 x 5.08 cm)	None / Integral	1/4" (0.64 cm)
<b>9516</b> Ⓢ	9516	RB 2-3/8	6-13/16" x 3-3/16" x 2-1/16" (17.30 x 8.10 x 5.24 cm)	Lid: 1/2" (1.27 cm) Base: 1-9/16" (3.97 cm)	7-1/2" x 4.0" x 2-3/8" (19.05 x 10.16 x 6.03 cm)	None / Integral	1/4" (0.64 cm)
<b>9517</b> Ⓢ	9517	RB 2-3/8	6-13/16" x 3-3/16" x 2-1/16" (17.30 x 8.10 x 5.24 cm)	Lid: 7/8" (2.22 cm) Base: 1-3/16" (3.02 cm)	7-1/2" x 4.0" x 2-3/8" (19.05 x 10.16 x 6.03 cm)	None / Integral	1/4" (0.64 cm)
<b>9518</b> Ⓢ	9518	RB 2-3/4	6-13/16" x 3-3/16" x 2-7/16" (17.30 x 8.10 x 6.19 cm)	Lid: 1/2" (1.27 cm) Base: 1-15/16" (4.92 cm)	7-1/2" x 4.0" x 2-3/4" (19.05 x 10.16 x 6.99 cm)	None / Integral	1/4" (0.64 cm)
<b>9519</b> Ⓢ	9519	RB 2-3/4	6-13/16" x 3-3/16" x 2-7/16" (17.30 x 8.10 x 6.19 cm)	Lid: 7/8" (2.22 cm) Base: 1-9/16" (3.97 cm)	7-1/2" x 4.0" x 2-3/4" (19.05 x 10.16 x 6.99 cm)	None / Integral	1/4" (0.64 cm)
<b>9520</b> Ⓢ	9520	RB 3-1/8	6-13/16" x 3-3/16" x 2-13/16" (17.30 x 8.10 x 7.14 cm)	Lid: 7/8" (2.22 cm) Base: 1-15/16" (4.92 cm)	7-1/2" x 4.0" x 3-1/8" (19.05 x 10.16 x 7.94 cm)	None / Integral	1/4" (0.64 cm)
<b>2500</b> Ⓢ	2500	RC 1-3/4	7-9/16" x 5-7/8" x 1-7/16" (19.21 x 14.92 x 3.65 cm)	Lid: 5/8" (1.59 cm) Base: 13/16" (2.06 cm)	8-1/2" x 7.0" x 1-3/4" (21.59 x 17.78 x 4.45 cm)	None / Integral	7/16" (1.11 cm)
<b>2509</b> Ⓢ	2509	RC 2-3/8	7-9/16" x 5-7/8" x 2-1/16" (19.21 x 14.92 x 5.24 cm)	Lid: 1.0" (2.54 cm) Base: 1-1/8" (2.86 cm)	8-1/2" x 7.0" x 2-3/8" (21.59 x 17.78 x 6.03 cm)	None / Integral	7/16" (1.11 cm)
<b>2513</b> Ⓢ	2513	RC 3-7/8	7-9/16" x 5-7/8" x 3-9/16" (19.21 x 14.92 x 9.05 cm)	Lid: 1.0" (2.54 cm) Base: 2-5/8" (6.67 cm)	8-1/2" x 7.0" x 3-7/8" (21.59 x 17.78 x 9.84 cm)	H001 / Integral	7/16" (1.11 cm)
<b>2524</b> Ⓢ	2524	RF 1-3/4	8-5/8" x 4.0" x 1-7/16" (21.91 x 10.16 x 3.65 cm)	Lid: 5/8" (1.59 cm) Base: 13/16" (2.06 cm)	9-1/2" x 5.0" x 1-3/4" (24.13 x 12.70 x 4.45 cm)	None / Integral	7/16" (1.11 cm)
<b>2527</b> Ⓢ	2527	RF 3-1/8	8-5/8" x 4.0" x 2-13/16" (21.91 x 10.16 x 7.14 cm)	Lid: 5/8" (1.59 cm) Base: 2-3/16" (5.56 cm)	9-1/2" x 5.0" x 3-1/8" (24.13 x 12.70 x 7.94 cm)	H001 / Integral	7/16" (1.11 cm)

# The Airmold® R-Series

MODEL #	STOCK #	DESCRIPTION	DIMENS. (INSIDE: L x W x D) (D X E X F)	INSIDE DEPTH (INSIDE: LID, BASE)	DIMENS. (OUTSIDE: L x W x D) (A x B x C)	STANDARD: HANDLE / LATCH	ROUTED DEPTH = I
<b>2532</b> Ⓢ	2532	RH 1-3/4	9-1/8" x 6-1/2" x 1-7/16" (23.18 x 16.51 x 3.65 cm)	Lid: 5/8" (1.59 cm) Base: 13/16" (2.06 cm)	10.0" x 7-1/2" x 1-3/4" (25.40 x 19.05 x 4.45 cm)	None / Integral	7/16" (1.11 cm)
<b>2533</b> Ⓢ	2533	RH 2-3/8	9-1/8" x 6-1/2" x 2-1/16" (23.18 x 16.51 x 5.24 cm)	Lid: 1.0" (2.54 cm) Base: 1-1/8" (2.86 cm)	10.0" x 7-1/2" x 2-3/8" (25.40 x 19.05 x 6.03 cm)	None / Integral	7/16" (1.11 cm)
<b>2534</b> Ⓢ	2534	RH 3-1/8	9-1/8" x 6-1/2" x 2-13/16" (23.18 x 16.51 x 7.14 cm)	Lid: 5/8" (1.59 cm) Base: 2-3/16" (5.56 cm)	10.0" x 7-1/2" x 3-1/8" (25.40 x 19.05 x 7.94 cm)	H001 / Integral	7/16" (1.11 cm)
<b>2541</b> Ⓢ	2541	RH 3-7/16	9-1/8" x 6-1/2" x 3-1/8" (23.18 x 16.51 x 7.94 cm)	Lid: 1.0" (2.54 cm) Base: 2-3/16" (5.56 cm)	10.0" x 7-1/2" x 3-7/16" (25.40 x 19.05 x 8.73 cm)	H001 / Integral	7/16" (1.11 cm)
<b>2537</b> Ⓢ	2537	RH 3-7/8	9-1/8" x 6-1/2" x 3-9/16" (23.18 x 16.51 x 9.05 cm)	Lid: 1.0" (2.54 cm) Base: 2-5/8" (6.67 cm)	10.0" x 7-1/2" x 3-7/8" (25.40 x 19.05 x 9.84 cm)	H001 / Integral	7/16" (1.11 cm)
<b>2547</b> Ⓢ	2547	RK 2-3/8	10-1/8" x 4-1/4" x 2-1/16" (25.72 x 10.80 x 5.34 cm)	Lid: 15/16" (2.38 cm) Base: 1-1/8" (2.86 cm)	11.0" x 5-1/4" x 2-3/8" (27.94 x 13.34 x 6.03 cm)	None / Integral	7/16" (1.11 cm)
<b>2549</b> Ⓢ	2549	RK 3-1/8	10-1/8" x 4-1/4" x 2-13/16" (25.72 x 10.80 x 7.14 cm)	Lid: 5/8" (1.59 cm) Base: 2-3/16" (5.56 cm)	11.0" x 5-1/4" x 3-1/8" (27.94 x 13.34 x 7.94 cm)	H001 / Integral	7/16" (1.11 cm)
<b>9624</b> Ⓢ	9624	RK 3-9/16	10-1/8" x 4-1/4" x 3-1/4" (25.72 x 10.80 x 8.26 cm)	Lid: 5/8" (1.59 cm) Base: 2-5/8" (6.67 cm)	11.0" x 5-1/4" x 3-9/16" (27.94 x 13.34 x 9.05 cm)	H001 / Integral	7/16" (1.11 cm)
<b>2560</b> Ⓢ	2560	RN 1-3/4	11-3/8" x 5-1/4" x 1-7/16" (28.89 x 13.34 x 3.65 cm)	Lid: 5/8" (1.59 cm) Base: 13/16" (2.06 cm)	12-1/4" x 6-1/4" x 1-3/4" (31.12 x 15.88 x 4.45 cm)	None / Integral	7/16" (1.11 cm)
<b>2569</b> Ⓢ	2569	RN 3-7/16	11-3/8" x 5-1/4" x 3-1/8" (28.89 x 13.34 x 7.94 cm)	Lid: 15/16" (2.38 cm) Base: 2-3/16" (5.56 cm)	12-1/4" x 6-1/4" x 3-7/16" (31.12 x 15.88 x 8.73 cm)	H001 / Integral	7/16" (1.11 cm)
<b>2565</b> Ⓢ	2565	RN 3-7/8	11-3/8" x 5-1/4" x 3-9/16" (28.89 x 13.34 x 9.05 cm)	Lid: 15/16" (2.38 cm) Base: 2-5/8" (6.67 cm)	12-1/4" x 6-1/4" x 3-7/8" (31.12 x 15.88 x 9.84 cm)	H001 / Integral	7/16" (1.11 cm)
<b>2574</b> Ⓢ	2574	RQ 1-3/4	11-3/8" x 7.0" x 1-7/16" (28.89 x 17.78 x 3.65 cm)	Lid: 5/8" (1.59 cm) Base: 13/16" (2.06 cm)	12-1/4" x 8.0" x 1-3/4" (31.12 x 20.32 x 4.45 cm)	None / Integral	7/16" (1.11 cm)
<b>2581</b> Ⓢ	2581	RQ 2-1/16	11-3/8" x 7.0" x 1-3/4" (28.89 x 17.78 x 4.45 cm)	Lid: 5/8" (1.59 cm) Base: 1-1/8" (2.86 cm)	12-1/4" x 8.0" x 2-1/16" (31.12 x 20.32 x 5.24 cm)	None / Integral	7/16" (1.11 cm)
<b>2575</b> Ⓢ	2575	RQ 2-3/8	11-3/8" x 7.0" x 2-1/16" (28.89 x 17.78 x 5.24 cm)	Lid: 1.0" (2.54 cm) Base: 1-1/8" (2.86 cm)	12-1/4" x 8.0" x 2-3/8" (31.12 x 20.32 x 6.03 cm)	None / Integral	7/16" (1.11 cm)
<b>7144</b> Ⓢ	7144	RQ 2-3/4	11-3/8" x 7.0" x 2-3/8" (28.89 x 17.78 x 6.03 cm)	Lid: 1-1/4" (3.18 cm) Base: 1-1/8" (2.86 cm)	12-1/4" x 8.0" x 2-3/4" (31.12 x 20.32 x 6.99 cm)	None / Integral	7/16" (1.11 cm)
<b>2577</b> Ⓢ	2577	RQ 3-1/8	11-3/8" x 7.0" x 2-13/16" (28.89 x 17.78 x 7.14 cm)	Lid: 5/8" (1.59 cm) Base: 2-3/16" (5.56 cm)	12-1/4" x 8.0" x 3-1/8" (31.12 x 20.32 x 7.94 cm)	H052 / Integral	7/16" (1.11 cm)
<b>2579</b> Ⓢ	2579	RQ 3-1/8	11-3/8" x 7.0" x 3-9/16" (28.89 x 17.78 x 9.05 cm)	Lid: 1.0" (2.54 cm) Base: 2-5/8" (6.67 cm)	12-1/4" x 8.0" x 3-7/8" (31.12 x 20.32 x 9.84 cm)	H001 / Integral	7/16" (1.11 cm)
<b>2585</b> Ⓢ	2585	RQ 4-1/4	11-3/8" x 7.0" x 3-7/8" (28.89 x 17.78 x 9.84 cm)	Lid: 1-1/4" (3.18 cm) Base: 2-5/8" (6.67 cm)	12-1/4" x 8.0" x 4-1/4" (31.12 x 20.32 x 10.80 cm)	H001 / Integral	7/16" (1.11 cm)

# The Airmold® R-Series

\* Please Note: The Airmold Series is production-run only, no stock. See ordering selection and information on pages (37 - 39)

MODEL #	STOCK #	DESCRIPTION	DIMENS. (INSIDE: L x W x D) (D X E X F)	INSIDE DEPTH (INSIDE: LID, BASE)	DIMENS. (OUTSIDE: L x W x D) (A x B x C)	STANDARD: HANDLE / LATCH	ROUTED DEPTH = I
<b>2588</b> Ⓢ	2588	RT 1-3/4	11-5/8" x 3-1/4" x 1-7/16" (29.53 x 8.26 x 3.65 cm)	Lid: 5/8" (1.59 cm) Base: 13/16" (2.06 cm)	12-1/2" x 4-1/4" x 1-3/4" (31.75 x 10.80 x 4.45 cm)	None / Integral	7/16" (1.11 cm)
<b>2590</b> Ⓢ	2590	RT 3-1/8	11-5/8" x 3-1/4" x 2-13/16" (29.53 x 8.26 x 7.14 cm)	Lid: 5/8" (1.59 cm) Base: 2-3/16" (5.56 cm)	12-1/2" x 4-1/4" x 3-1/8" (31.75 x 10.80 x 7.94 cm)	None / Integral	7/16" (1.11 cm)
<b>2618</b> Ⓢ	2618	RV 2-1/16	12-11/16" x 8-15/16" x 1-3/4" (32.23 x 22.70 x 4.45 cm)	Lid: 5/8" (1.59 cm) Base: 1-1/8" (2.86 cm)	13-1/2" x 10.0" x 2-1/16" (34.29 x 25.40 x 5.24 cm)	None / Integral	7/16" (1.11 cm)
<b>2596</b> Ⓢ	2596	RV 2-3/8	12-11/16" x 8-15/16" x 2-1/16" (32.23 x 22.70 x 5.24 cm)	Lid: 1.0" (2.54 cm) Base: 1-1/8" (2.86 cm)	13-1/2" x 10.0" x 2-3/8" (34.29 x 25.40 x 6.03 cm)	None / Integral	7/16" (1.11 cm)
<b>2597</b> Ⓢ	2597	RV 3-1/8	12-11/16" x 8-15/16" x 2-13/16" (32.23 x 22.70 x 7.14 cm)	Lid: 5/8" (1.59 cm) Base: 2-3/16" (5.56 cm)	13-1/2" x 10.0" x 3-1/8" (34.29 x 25.40 x 7.94 cm)	None / Integral	7/16" (1.11 cm)
<b>2611</b> Ⓢ	2611	RV 3-7/16	12-11/16" x 8-15/16" x 2-13/16" (32.23 x 22.70 x 7.14 cm)	Lid: 5/8" (1.59 cm) Base: 2-13/16" (7.14 cm)	13-1/2" x 10.0" x 3-7/16" (34.29 x 25.40 x 8.73 cm)	H024 / Integral	7/16" (1.11 cm)
<b>2600</b> Ⓢ	2600	RV 4	12-11/16" x 8-15/16" x 3-11/16" (32.23 x 22.70 x 9.67 cm)	Lid: 1.0" (2.54 cm) Base: 2-3/4" (6.99 cm)	13-1/2" x 10.0" x 4.0" (34.29 x 25.40 x 10.16 cm)	H052 / Integral	7/16" (1.11 cm)
<b>2605</b> Ⓢ	2605	RV 5-1/8	12-11/16" x 8-15/16" x 4-3/4" (32.23 x 22.70 x 12.07 cm)	Lid: 1-1/2" (3.81 cm) Base: 3-1/4" (8.26 cm)	13-1/2" x 10.0" x 5-1/8" (34.29 x 25.40 x 13.02 cm)	H024 / Integral	7/16" (1.11 cm)
<b>2619</b> Ⓢ	2619	RV 6-1/8	12-11/16" x 8-15/16" x 5-5/8" (32.23 x 22.70 x 14.29 cm)	Lid: 1-7/8" (4.76 cm) Base: 3-3/4" (9.53 cm)	13-1/2" x 10.0" x 6-1/8" (34.29 x 25.40 x 15.56 cm)	H024 / Integral	7/16" (1.11 cm)
<b>7205</b> Ⓢ	7205	RW 4-3/4 Opt. Integral Handle	14.0" x 10-3/4" x 4-1/4" (35.56 x 27.31 x 10.80 cm)	Lid: 1-3/8" (3.49 cm) Base: 2-7/8" (7.30 cm)	15-1/2" x 12-1/4" x 4-3/4" (39.37 x 31.12 x 12.07 cm)	H023OM / Integral	1-1/4" (3.18 cm)
<b>7279</b> Ⓢ	7279	RW 5-1/2 Opt. Integral Handle	14.0" x 10-3/4" x 5.0" (35.56 x 27.31 x 12.70 cm)	Lid: 2-1/8" (5.40 cm) Base: 2-7/8" (7.30 cm)	15-1/2" x 12-1/4" x 5-1/2" (39.37 x 31.12 x 13.97 cm)	H023OM / Integral	1-1/4" (3.18 cm)
<b>7207</b> Ⓢ	7207	RW 5-1/2 Opt. Integral Handle	14.0" x 10-3/4" x 5.0" (35.56 x 27.31 x 12.70 cm)	Lid: 1-3/8" (3.49 cm) Base: 3-5/8" (9.21 cm)	15-1/2" x 12-1/4" x 5-1/2" (39.37 x 31.12 x 13.97 cm)	H023OM / Integral	1-1/4" (3.18 cm)
<b>7203</b> Ⓢ	7203	RW 6-1/4 Opt. Integral Handle	14.0" x 10-3/4" x 5-3/4" (35.56 x 27.31 x 14.61 cm)	Lid: 2-1/8" (5.40 cm) Base: 3-5/8" (9.21 cm)	15-1/2" x 12-1/4" x 6-1/4" (39.37 x 31.12 x 15.88 cm)	H023OM / Integral	1-1/4" (3.18 cm)
<b>14532</b> Ⓢ	14532	RX 3 Opt. Integral Handle	17.0" x 13.0" x 2-1/2" (43.18 x 33.02 x 6.35 cm)	Lid: 7/8" (2.22 cm) Base: 1-5/8" (4.13 cm)	18-1/2" x 14-1/2" x 3.0" (46.99 x 36.83 x 7.62 cm)	H023OM / Integral	15/16" (2.38 cm)
<b>2725</b> Ⓢ	2725	RX 5 Opt. Integral Handle	17.0" x 13.0" x 4-1/2" (43.18 x 33.02 x 11.43 cm)	Lid: 1-3/8" (3.49 cm) Base: 3-1/8" (7.94 cm)	18-1/2" x 14-1/2" x 5.0" (46.99 x 36.83 x 12.70 cm)	H023OM / Integral	15/16" (2.38 cm)
<b>2728</b> Ⓢ	2728	RX 6-1/4 Opt. Integral Handle	17.0" x 13.0" x 5-5/8" (43.18 x 33.02 x 14.29 cm)	Lid: 1-3/4" (4.45 cm) Base: 3-7/8" (9.84 cm)	18-1/2" x 14-1/2" x 6-1/4" (46.99 x 36.83 x 15.88 cm)	H023OM / Integral	15/16" (2.38 cm)
<b>2742</b> Ⓢ	2742	RX 8 Opt. Integral Handle	17.0" x 13.0" x 7-3/8" (43.18 x 33.02 x 18.73 cm)	Lid: 3-1/2" (8.89 cm) Base: 3-7/8" (9.84 cm)	18-1/2" x 14-1/2" x 8.0" (46.99 x 36.83 x 20.32 cm)	H023OM / L037	15/16" (2.38 cm)



# Vision 20™

The Vision 20 combines blow mold and injection mold technologies resulting in an innovative solution for packaging and merchandising! The base is made with double wall blow mold construction. The lid is manufactured w/an "ultra-clear" injection mold terpolymer resin. The result is a startling efficient carrying case offering limitless customized options with "window-like" clarity lids for interior viewing!

### Features:

- "Window-like" clarity lids
- Double wall base construction allows for custom molded interiors
- (2) Locking points



- Gray with "window-like" view
- Clear lid made of Terpolymer



**50900**®  
50900

Interior Dimensions (L x W x D):  
17-3/4" x 12-3/4" x 5-1/2" (45.09 x 32.39 x 13.99 cm)  
Packed: 1/ctn



- Gray with "window-like" view
- Clear lid made of Polypropylene



**50901**®  
50901

Interior Dimensions (L x W x D):  
17-3/4" x 12-3/4" x 5-1/2" (45.09 x 32.39 x 13.99 cm)  
Packed: 1/ctn

## Blow Mold Tradesman™ Case

Featuring extra thick wall construction, the Blow Mold Tradesman is one of our most durable cases. This high-density polyethylene (HDPE) case is resistant to most common chemicals and gasoline.

### Features:

- Extra thick wall construction
- Logo area for customization
- Impervious to most chemicals and gasoline

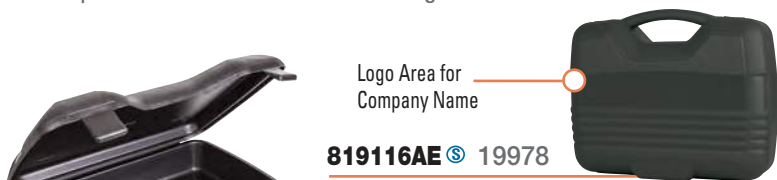

Logo Area for Company Name

**819116AE**® 19978

Black, Double Wall Case w/Logo Plate Area  
Interior Dimensions (L x W x D):  
15.0" x 8-1/2" x 3-1/2" (38.10 x 21.59 x 8.89 cm)  
Packed: 1/ctn

See page 5 for customization options



## Beta Case

Durability is built into this case! Made of high-density polyethylene (HDPE), this case is impervious to most common chemicals. Featuring an integral handle, hinge and latch system, the Beta Case is built tough.

### Features:

- Integral handle, hinge and latch system
- Stackable



Small Logo Plate

MODEL #	STOCK #	DESCRIPTION: BLACK	DIMENSIONS (INSIDE: L x W x D)	DEPTH (INSIDE: LID, BASE)	PACKED
<b>819116AE</b> ®	19978	Double Wall Case	13.0" x 8-1/2" x 2-3/4" (33.02 x 21.59 x 6.99 cm)	Lid: 1-1/2" (3.81 cm) Base: 1-1/2" (3.81 cm)	16/ctn
<b>50237</b> ®	50237	Double Wall Case w/Logo Plate Area	13.0" x 8-1/2" x 2-3/4" (33.02 x 21.59 x 6.99 cm)	Lid: 1-1/2" (3.81 cm) Base: 1-1/2" (3.81 cm)	16/ctn

\* Express Service (E Symbol) items are for quantities 500 and less.  
For greater quantities call customer service: 1-800-344-5716.

# Double Wall Shipper Mailers

Reusable shipping containers from Flambeau will help you save money and give you the durability needed to protect your cargo while in transit. Our blow mold mailers feature double wall construction and are stackable. Offered with our standard convoluted foam, they are designed to protect even the most sensitive cargo. Lids and bases are separate pieces for loading convenience and feature overlapping positive edges to reduce lid movement and provide a natural dust barrier. Made of high-density polyethylene (HDPE) our mailers are impervious to most common chemicals and gasoline.

**Features:**

- Convoluted foam in the lid and base
- Double wall construction
- Crush-resistant and stackable



MODEL #	STOCK #	DIMENSIONS (OUTSIDE: L x W x D)	DIMENSIONS (INSIDE: L x W x D)	MAXIMUM LOAD SIZE: (L x W x D)	PACKED
<b>8792-PI04</b>	8792-PI04	12.0" x 10.0" x 3.0" (30.48 x 25.40 x 7.62 cm)	9-1/2" x 7.0" x 1-5/8" (24.13 x 17.78 x 4.13 cm)	8-1/2" x 6.0" x 1.0" (21.59 x 15.24 x 2.54 cm)	36/ctn
<b>8793-PI05</b>	8793-PI05	12.0" x 10.0" x 5.0" (30.48 x 25.40 x 12.70 cm)	9-1/2" x 7.0" x 4.0" (24.13 x 17.78 x 10.16 cm)	8-1/2" x 6.0" x 3-1/4" (21.59 x 15.24 x 8.26 cm)	18/ctn
<b>8794-PI06</b>	8794-PI06	14.0" x 12.0" x 3.0" (35.56 x 30.48 x 7.62 cm)	11-1/2" x 9.0" x 1-5/8" (29.21 x 22.86 x 4.13 cm)	10-1/2" x 8.0" x 1.0" (26.67 x 20.32 x 2.54 cm)	24/ctn
<b>8286-PI07</b>	8286-PI07	14.0" x 12.0" x 5.0" (35.56 x 30.48 x 12.70 cm)	11-1/2" x 9.0" x 4.0" (29.21 x 22.86 x 10.16 cm)	10-1/2" x 8.0" x 3-1/4" (26.67 x 20.32 x 8.26 cm)	12/ctn
<b>8161-PI19</b>	8161-PI19	21.0" x 15.0" x 5.0" (53.34 x 38.10 x 12.70 cm)	18.0" x 12.0" x 4.0" (45.72 x 30.48 x 10.16 cm)	17.0" x 11.0" x 2-1/2" (43.18 x 27.94 x 6.35 cm)	6/ctn

\* Express Service (E Symbol) items are for quantities 500 and less. For greater quantities call customer service: 1-800-344-5716.

# DOCU-BOXES™

These two boxes were designed especially for holding and protecting operator manuals, instruction pamphlets and special documents of many varieties and types.



**819768AE** **NEW**  
819768AE

Description: Bi-Fold DOCU-BOX™, fits documents measuring up to 13-7/16" L x 9-3/16" W x 1-27/32" D (34.14 x 23.37 x 4.67 cm)  
Outside Dimensions (L x W x D): 16-17/64" x 12-1/64" x 2-57/64" (41.30 x 30.53 x 7.34 cm)  
Packed: 24/ctn



**819769AE** **NEW**  
819769AE

Description: Tri-Fold DOCU-BOX™, fits documents measuring up to 12" L x 9" W x 1-3/4" D (30.48 x 22.86 x 4.44 cm)  
Outside Dimensions (L x W x D): 14" x 11" x 2-57/64" (35.56 x 27.94 x 7.34 cm)  
Packed: 24/ctn





## Double Coverage™ Rifle Case

Flambeau® is excited to offer the Double Coverage Rifle Case as part of Flambeau's extensive line of weapon storage products. The case is manufactured with a double wall of HDPE plastic that forms the base and lid components. Air pockets created between the two walls during blow molding provide superior shock and impact resistance resulting in an extremely heavy-duty carrying case that performs as well or better than heavy-wall injection mold products. The case fits one scoped rifle or shotgun up to 47.5" long.

### Features:

- Easily stacks for shipment and stands for display
- (4) Large over-center ABS latches
- Off-the-shelf availability
- Four (4) Tamper-resistant heavy duty steel lid-to-base pin hinges
- Built-in lock points to secure contents
- Permanent integral handle
- Convoluted foam in lid & base
- Customizable features include die cut foam and molded interior



The Double Coverage Case is designed to hold one scoped rifle or shotgun up to 47.5" long



Air pockets between the two walls provide superior shock and impact protection

**5114NK** **NEW**  
5114NK

Description: black w/foam insert  
Interior Dimensions (L x W x D):  
48-3/32" x 10-13/32" x 3-13/64"  
(122.17 x 26.42 x 8.13 cm)  
Packed:1/ctn



# Case Handles & Latches

## Infinity Cases: (Pages 22 - 25)



Handle - H052  
Styles: FH, FQ (4-1/2 only) & FV



Overmolded Grip Handle - H0230M  
Styles: FH, FQ, FV, FW, FX and FZ



Handle - H074  
Style: FZ



Handle - H023  
Styles: FW and FX



Latch - 913713A  
Style: FW



Latch - L115  
Style: FZ (8-1/2)



Latch - L089  
Styles: FH, FQ and FV



Latch - L095  
Style: FX



Latch - L116  
Style: FZ (7)

## "P" Series: (Pages 26 - 29)



Handle - H001  
Styles: PC, PF (3-1/8 only) & PH



Handle - H052 / Styles: PQ (3-7/16, 3-13/16 and 3-7/8 only), PV



Handle - H023 / Styles: PW (4, 4-3/4, 5-1/2 & 6-1/4 only), PX (8 only), PZ



Handle - Integral  
Styles: PW, PX & PZ



Latch - L089  
Styles: PB, PC, PF, PH, PQ, PV



Latch - 913713A / Styles: PW (4, 4-3/4, 5-1/2 and 6-1/4 only), PX (8 only)



Latch - L026 / Styles: PW 6-1/4 only PX (5 & 8 only)



Latch - L037 / Styles: PX (3-1/2, 5, 6-1/4 and 8 only)



Latch - L095  
Use with Style: PZ

## Airmold Series: (Pages 36 - 39)



Handle - H001  
Styles: RA (3-1/8 & 3-7/16 only), RC (3-7/8 only), RF (3-1/8 only), RH (3-1/8, 3-7/16 & 3-7/8 only), RK (3-1/8 & 3-9/16 only), RN (3-7/16 & 3-7/8 only) and RQ (3-7/8 & 4-1/4 only)



Handle - H024  
Style: RV (3-7/16, 5-1/8 & 6-1/8 only)



Handle - H023  
Styles: RW, RX



Latch - L037  
Style: RX (8 only)



Latch - Integral / Styles: RA, RB, RC, RF, RH, RK, RN, RQ, RT, RV, RW, and RX (3, 5 & 6-1/4 only)

**Please Note:** Some cases do not have options available, please see each case family (pages 22-43).

## Optional Handles and Latches



**Handle - Integral**  
 "P" Series Styles: PW, PX & PZ  
 Airmold Series Styles: RW & RX



**Handle - H074**  
 Gear Box and Custom Case  
 Applications Only



**Handle - H040**  
 Custom Case  
 Applications Only



**Infinity Metal Latch - L078**  
 Styles FW, FX and Custom  
 Case Applications



**Latch - L115**  
 Custom Case  
 Applications Only



**Latch - L0110**  
 Custom Case  
 Applications Only

## Display Windows

The windows are manufactured from a clear plastic resin and can be hot stamped with your company name or logo. Four sizes of windows are available and are custom fit to our pin hinge style cases.



**AR1466 (L x W)**  
 7-1/2" x 3-1/2" (19.05 x 8.89 cm)



**AR1536 (L x W)**  
 10-1/4" x 3.0" (26.04 x 7.62 cm)



**X-1191 Small (L x W)**  
 5-15/16" x 1-15/16" (15.08 x 4.92 cm)



**X-1193 Large (L x W)**  
 8-7/16" x 2-3/16" (21.43 x 5.56 cm)

## Additional Options



**Flambeau Purge Valve**



**Perimeter Gasket**



**Custom Small & Large Exterior Logo Plate - Additional Tooling Expense**



**Lid Stays**



**Interior Door(s)**  
*Additional Tooling Expense*



**Interior Tray(s)**  
*Additional Tooling Expense*



**Security Feature**



**Removable Lid**



**Literature Holder Routed Slot**



**Literature Holder Plastic Clip - X893**



**Literature Holder Elastic Strap**



**Pallets and/or File Folders**

*For information on Flambeau's Custom Capabilities see the Capabilities section starting on page 2*



## Atlas 12 Case

**NEW**



Metal insert lock holes located to side of each latch for added security



Over-center latches, automatic pressure relief valve and overmold handle

First in a new family of cases engineered for demanding industrial, commercial and military applications. The Atlas 12 is built with heavy wall, high-impact polypropylene material and is waterproof when submerged. Designed to be ATA (Air Transport Association) compliant, featuring an automatic pressure relief valve, metal insert lock holes, an overmold handle and single-throw, over center, hardened ABS latches. A tongue-and-groove, lid-to-base fit is incorporated into the design, with stacking and standing features and multiple decorating options for private labeling. The Atlas 12 also accommodates stock and/or custom foam interiors with mounting positions for lid or base pallets.

### Features:

- Made from high-impact polypropylene
- Over-center latches
- Pressure relief valve
- Steel pin hinges
- Stackability feature
- ATA compliant

MODEL #	STOCK #	DESCRIPTION:	DIMENS. (INSIDE: L x W x D)	DIMENS. (OUTSIDE: L x W x D)	PACKED
<b>AS1209</b>	AS1209	Black, No Foam (Not Shown)	12.0" x 9.0" x 4-5/8" (33.78 x 28.83 x 13.08 cm)	13-5/16" x 11-11/32" x 5-5/32" (30.48 x 22.86 x 11.75 cm)	1/ctn
<b>AS1209F</b>	AS1209F	Black with Foam Insert	12.0" x 9.0" x 4-5/8" (33.78 x 28.83 x 13.08 cm)	13-5/16" x 11-11/32" x 5-5/32" (30.48 x 22.86 x 11.75 cm)	1/ctn



**MADE IN U.S.A.**

*Distinctive Packaging For Quality Brands And Products™*



## Waterproof Satchels

The new Waterproof Satchels feature heavy wall construction with a 360 degree seal. Available in two sizes, these satchels feature two locking points for extra security, a rubber overmolded handle for easy portability, a recessed lid for extra work space, rust proof steel pin hinge construction & a durable polycarbonate lid with ribbing design providing extra strength for crush resistance. The open core interior can be custom molded or inserted with die-cut foam to safely store and protect your valuables.

### Features:

- Locking points
- Overmolded handle
- Snap-shut latches
- Rubber seal
- Ribbing design for extra strength
- Steel pin hinge construction
- Recessed lid for work space
- Durable polycarbonate lid
- Stackable



Locking Point



**3000WPOC**  
3000WPOC

Description: Waterproof Satchel 3000  
Interior Dimensions (L x W x D):  
12-3/4" x 9-2/3" x 4-1/5" (31.97 x 24.28 x 10.56 cm)  
Base: 2-1/2", Lid: 1-3/5"  
Packed: 2/ctn



**4000WPOC**  
4000WPOC

Description: Waterproof Satchel 4000  
Interior Dimensions (L x W x D):  
16-1/5" x 11-1/3" x 6-3/4" (41.17 x 28.70 x 17.17 cm)  
Base: 4-7/8", Lid: 1-7/8"  
Packed: 2/ctn



**Rubber Seal**  
(shown on clear for illustration purposes)





# Waterproof Tuff Tainers®

Waterproof Tuff Tainers are clear, open core compartment boxes that are equipped with tight sealing latches and a waterproof gasket seal. Great for protecting valuable electronic equipment and other water sensitive items.



**WT3000**  
6723TE

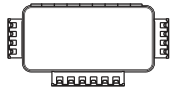

**WT4000**  
6741TE

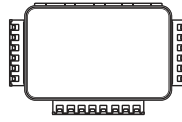

**WT5000**  
6750TE

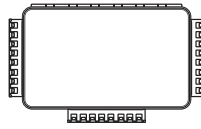



Protect your expensive  
valuables from water damage!



**WT5001**  
6751TE

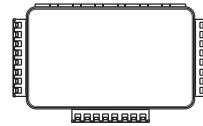

MODEL #	STOCK #	DESCRIPTION:	DIMENS. (INSIDE: L x W x D)	DIMENS. (OUTSIDE: L x W x D)	PACKED
<b>WT3000</b>	6723TE	Waterproof No Dividers	7-5/8" x 3-9/16" x 1.0" (19.38 x 9.05 x 2.54 cm)	9-1/8" x 4-15/16" x 1-1/2" (23.19 x 12.55 x 3.81 cm)	12/ctn
<b>WT4000</b>	6741TE	Waterproof No Dividers	9-5/16" x 5-13/16" x 1-1/4" (23.65 x 14.77 x 3.18 cm)	10-51/64" x 7-3/16" x 1-57/64" (27.41 x 18.29 x 4.80 cm)	6/ctn
<b>WT5000</b>	6750TE	Waterproof No Dividers	12-1/2" x 7-1/2" x 1-7/16" (31.75 x 19.05 x 3.65 cm)	14.0" x 8-7/8" x 2-7/64" (35.56 x 22.58 x 5.33 cm)	6/ctn
<b>WT5001</b>	6751TE	Waterproof No Dividers	12-1/2" x 7-1/2" x 2-5/16" (31.75 x 19.05 x 5.88 cm)	14.0" x 8-7/8" x 9-1.2" (35.56 x 22.58 x 7.67 cm)	6/ctn

**Tactical Cases**



2 Layers of foam in base:  
Convulated

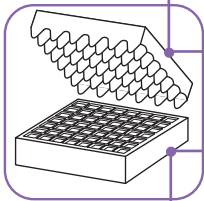

Diced Foam

Convolute foam option on lid and base



**6791DDC**  
6791DDC

**Small Tactical Case  
(Double Deep Pistol Case)**

Store more in one! The Small Tactical Case, a.k.a. Double Deep case, features a deep, 6" base for extra storage, 4 pad lock holes, 2 tough snap-fit latches and an integral off-set handle for easier transport. Rugged, stackable and extremely durable, this case is suitable for tool storage, camera equipment, firearms, emergency kits, along with many more functions.



**6505PDW**  
6505PDW

**Medium Tactical Case  
(Hand-Held "AR" Case)**

The only case in the market that features a distinctive 32" length. The Medium Tactical Case can store and protect any valuables featuring a 5" depth, optional interchangeable divider compartments, 4 tough snap-fit latches and 4 pad lock holes for greater security. Stackable with high impact copolymer polypropylene walls, this rugged case provides durability for the toughest transport.

Customize Cases with Your Name/Company

Optional interchangeable divider compartments



## Large Tactical Case (Full "AR" With Scope)

- Durable egg-shell foam
- Four magazine pockets
- Adjustable strap option
- Integral handle for easy transport
- Four locking points for extra security
- Mechanical style hinge for added durability



**6506PDW**  
6506PDW



**NOTE:** Cases made of high impact co-polymer polypropylene material.

MODEL #	STOCK #	DESCRIPTION	DIMENSIONS (L x W x D)	PACKED
<b>6791DDC</b>	6791DDC	Small Tactical, 2 Layers of Foam: Diced on Bottom, Convolute on Top & Lid	16-1/4" x 12.0" x 5-1/2" (41.28 x 30.48 x 13.97 cm)	6/ctn
<b>6792DDC</b>	6792DDC	Small Tactical, No Foam	16-1/4" x 12.0" x 5-1/2" (41.28 x 30.48 x 13.97 cm)	6/ctn
<b>6505PDW</b>	6505PDW	Medium Tactical, Convolute Foam in Base & Lid With 2 Straps & Dividers	31-4/5" x 11-2/5" x 5.0" (80.82 x 28.93 x 12.70 cm)	1/ctn
<b>6506PDW</b>	6506PDW	Medium Tactical, No Foam	31-4/5" x 11-2/5" x 5.0" (80.82 x 28.93 x 12.70 cm)	1/ctn
<b>6500ARP</b>	6500ARP	Black w/Egg-Shell Foam with 2 Straps and Dividers	40.0" x 12.0" x 4.0" (101.60 x 30.48 x 10.16 cm)	1/ctn

**NEW**

**60100**  
60100



### Suppressor 7 (Aegis 7)

Description: with High Heat Resistant Foam, Includes (1) Locking Point, No Handle  
Interior Dimensions (L x W x D):  
6-2/50 x 3-1/2" x 1-3/4"  
(16.15 x 9.04 x 4.37 cm)  
Packed: 1/ctn

**NEW**

**60500**  
60500



### Suppressor 13 (Aegis 13)

Description: with High Heat Resistant Foam, Includes (2) Locking Points, Integral Handle  
Interior Dimensions (L x W x D):  
12-1/8" x 6-3/5" x 2-1/2"  
(30.68 x 16.71 x 6.35 cm)  
Packed: 1/ctn



# Pallet Packer

Flambeau's NEW Pallet Packer stacks securely and squarely on a 48" x 40" pallet. The Pallet Packer has many features.

**Features:**

- Tough polypropylene construction
- Ribbed walls for extra strength and durability
- Includes (4) hold down strap loops
- Double slit foam for maximum options to strap objects down
- Tongue & groove design with a dust proof seal
- (4) Locking points and (4) snap-shut latches

Saves thousands of dollars on freight by only stacking up to 2,880 cases (4610PP) per truck load or up to 3,120 cases (4610PPB) per truckload, it also fits within UPS/FedEx limits.



**NEW**

**4610PPB**  
4610PPB



**NEW**

**5010PP**  
5010PP



MODEL #	STOCK #	DESCRIPTION	EXT. DIMENSIONS (L x W x D)	PACKED
<b>4610PP</b>	4610PP	With Single Carton	45-3/4" x 10.0" x 3-1/2" (116.21 x 25.4 x 8.89 cm)	1/ctn
<b>4610PPB</b>	4610PPB	Without Carton (Stacks on Pallet)	45-3/4" x 10.0" x 3-1/2" (116.21 x 25.4 x 8.89 cm)	52/pallet
<b>5010PP</b>	5010PP	With Single Carton	45-3/4" x 10.0" x 3-1/2" (116.21 x 25.4 x 8.89 cm)	1/ctn

## Economy Rifle Case

- Largest economy single available
- Four locking points and piano style hinge
- Durable egg-shell foam

**6470SS**  
6470SS

Description: black w/egg-shell foam  
Interior Dimensions (L x W x D):  
53-5/8" x 126-1/8" x 3-3/4"  
(136.20 x 30.79 x 9.53 cm)  
Packed:1/ctn



Patent # D486,637

## Single Rifle Case

- Four locking points for extra security
- Combination of piano style hinge and brass hinge provide durability, safety and protection
- Oversized single fits most scoped rifles
- Durable egg-shell foam

**6489NK**  
6489NK

Description: black w/egg-shell foam  
Interior Dimensions (L x W x D):  
53-1/2" x 13-1/2" x 4-1/2"  
(135.89 x 34.29 x 11.43 cm)  
Packed:1/ctn



Patent # D486960

Customize All these Cases  
with Your name/company

## Double Rifle Case

- Four locking points for extra security
- Combination of piano style hinge and brass hinge provide durability, safety and protection
- Oversized case will accommodate two scoped rifles
- Durable egg-shell foam

**6499NK**  
6499NK

Description: black w/egg-shell foam  
Interior Dimensions (L x W x D):  
53-3/8" x 16-1/2" x 4-1/2"  
(136.20 x 41.91 x 11.43 cm)  
Packed:1/ctn



Patent # D486960

## Double Coverage™ Rifle Case

Flambeau Inc. is excited to offer its Double Coverage Rifle Case as part of Flambeau's extensive line of weapon storage products. The case is manufactured with a double wall of HD polypropylene plastic that forms the base and lid components. Air pockets created between the two walls during blow molding provide superior shock and impact resistance resulting in an extremely heavy-duty carrying case that performs as well or better than heavy-wall injection mold products for less cost. The case fits one scoped rifle or shotgun up to 47.5" long.

### Features:

- Stacks for shipment and stands for display
- (4) Large over-center ABS latches
- Off-the-shelf availability
- Four (4) Tamper-resistant heavy duty steel lid-to-base pin hinges
- Made from high-density polypropylene material
- Built-in lock points to secure contents
- Permanent integral handle
- Convolute foam base and lid
- Customizable features include die cut foam and Zerust® anti-corrosion protection



The Double Coverage Case is designed to hold one scoped rifle or shotgun up to 47.5" long



Air pockets between the two walls provide superior shock and impact protection

5114NK  
5114NK

**NEW**

Description: black w/foam insert  
Interior Dimensions (L x W x D):  
48-3/32" x 10-13/32" x 3-13/64"  
(122.17 x 26.42 x 8.13 cm)  
Packed:1/ctn





# Linesman Case

The Linesman Case is very unique yet versatile. This 43" long case is designed for multiple storage applications---long and deep enough to store and protect everything from fishing rods to small rifles, and everything in-between. The ergonomic offset handle helps balance the heaviest loads during transport.

## Features:

- Deep 6" base
- (4) Locking points
- Ergonomic off-set handle
- Tough ABS latches
- Piano-style hinge construction
- Stackable

MODEL #	STOCK #	DESCRIPTION	DIMENSIONS (L x W x D)	PACKED
<b>7450AP</b> <i>(Not shown)</i>	7450AP	Stock - No Foam	40.0" x 9-1/2" x 6.0" (101.63 x 24.05 x 15.24 cm)	1/ctn
<b>7450BG</b>	7450BG	8 - Pistol Foam	40.0" x 9-1/2" x 6.0" (101.63 x 24.05 x 15.24 cm)	1/ctn

**7450BG** 7450BG

## 8 Pistol Linesman Case



Finally a case large enough to hold your firearm collection! Ships complete with lid and base foam set designed to hold up to (8) firearms. Flexible foam allows for any size pistol to fit nicely in the slot. There's even enough room for an extra magazine next to each pistol.



## Stop Rust Gun Plug

Designed to protect valuable firearms up to 3 years from rusting during storage. Simply insert plug into barrel of gun and let the protection begin!

**6647ZR**  
6647ZR

Description: yellow plug molded with Zerust®  
Dimensions (L x W x D):  
3.0" (7.62 cm)  
Packed:12/ctn



**3 YEAR**  
**ZERUST**  
**PROTECTION**

The Stop Rust Gun Plug fits firearms ranging from .22 caliber to a 28 gauge shotgun

**NEW** Zerust® Toolboxes



**Protect your equipment  
from the elements!**



New Flambeau® Zerust® Toolboxes come with patented Zerust Anti-Rust protection to keep your tools and fasteners from rusting. All boxes include an overmolded seal to keep out the elements and provide an enclosed environment for harmless Zerust vapor to form an invisible protective coating on your tools. Lockable metal latches allow you to secure your investment.

**Features:**

- Zerust corrosion protection
- Water-resistant seal
- Lockable with steel latches

(See following page)







## Rust and Corrosion Inhibitors...The Best Way to Protect Your Valuable Investments!

Flambeau's EXCLUSIVE Zerust® products are the absolute best way to protect your gear from rust and corrosion. Molded into many Flambeau products, this patented polymer emits an odorless harmless vapor, forming a protective layer around metal surfaces for years of hassle-free, long-lasting rust and corrosion protection. Look for the Zerust symbol for products that include Zerust!

With Flambeau® Zerust® Protection

**No RUST with Zerust!**



Zerust® is a registered trademark of Northern Technologies International Corporation (NTIC)



9118ZR  
9118ZR

**NEW**



### 15" Zerust® Dry Box

Interior Dimensions (L x W x D):

15-3/4" x 9.0" x 11.0" (40 x 22.86 x 27.94 cm)

Packed: 4/ctn



9218ZR  
9218ZR

**NEW**



### 18" Zerust® Cantilever Toolbox

Interior Dimensions (L x W x D):

18.0" x 12.0" x 9.0" (45.72 x 30.48 x 22.86 cm)

Packed: 4/ctn



Clear blue window compartment for small, quick access



9219ZR  
9219ZR

**NEW**



### 19" Zerust® Toolbox with Lift-Out Tray

Interior Dimensions (L x W x D):

19.0" x 9.5" x 9.0" (48.26 x 24.13 x 22.86 cm)

Packed: 4/ctn







## Zerust® Toolboxes (continued)

### Features:

- Zerust corrosion protection
- Water-resistant seal
- Lockable with steel latches

**NEW**



Heavy steel clip on the inside and outside



**6535TH**  
6535TH

### Contractor Clipboard

- Heavy steel clips, inside and outside
- Pockets for business cards and collateral material such as folders and DVDs
- Secure latch to hold material safely inside

Interior Dimensions (L x W x D):

16.0" x 11.75" x 1-5/8" (40.64 x 29.85 x 4.13 cm)

Packed: 4/ctn



Made in China



**9222ZR**  
9222ZR



### 22" Zerust® Toolbox with Lift-Out Tray **NEW**

Interior Dimensions (L x W x D):

22.0" x 13.0" x 11.0" (55.88 x 33.02 x 27.94 cm)

Packed: 4/ctn



**9226ZR**  
9226ZR



### 26" Zerust® Toolbox with Lift-Out Tray **NEW**

Interior Dimensions (L x W x D):

26.0" x 13.0" x 11.0" (55.88 x 33.02 x 27.94 cm)

Packed: 2/ctn



Clear blue window compartment for small, quick access



Flambeau Utility Series Tool Boxes are far superior to other industrial tool boxes. Built with heavy-wall co-polymer polypropylene, the utility series will out-perform it's competition. Our heavy-duty cantilever trays are secured by rust-resistant hardware for extra longevity.

**Features:**

- Resistant to oil and common chemicals
- Tip-Guard™ (cantilever trays only)
- Removable interior trays
- Dent-proof and scratch resistant
- Lockable

**When You Need To It's Protected!**



# Utility Boxes

Flambeau Utility Boxes feature spacious open interiors and are manufactured from light-weight copolymer resins that are non-conductive, dent-proof, rust-proof and scratch-resistant.

### Features:

- Brass hinge and latch pins, tough recessed handles
- Positive action latches
- Models 1800 and 2100 have (2) 3/16" (2.06 cm) lock tabs
- Textured finish and tongue-and-groove construction



**1100**  
6734UB



**1200**  
6736UB



**1400**  
6742UB



**1700**  
6746UB

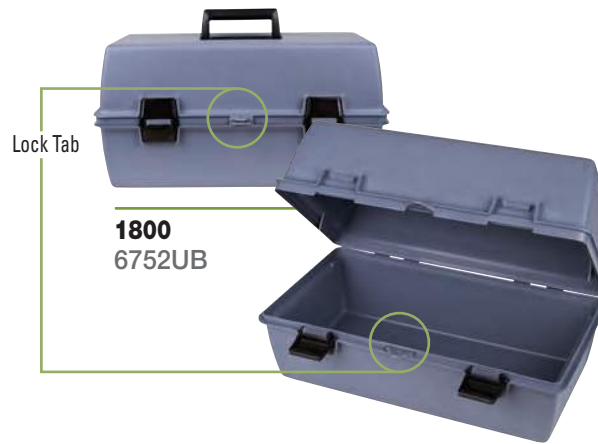

**1800**  
6752UB



**2100**  
6760UB

MODEL #	STOCK #	DESCRIPTION	DIMENS. (INSIDE: L x W x D)	LID, BASE DEPTH DIMENS.	DIMENS. (OUTSIDE: L x W x D)	PACKED
<b>1100</b>	6734UB	Gray Utility Box	11-1/8" x 5-3/4" x 4.0" (28.26 x 14.61 x 10.16 cm)	12-1/8" x 7-1/4" x 4-1/2" (30.80 x 18.42 x 11.43 cm)	Lid: 1-3/4" (4.45 cm) Base: 2-3/4" (6.99 cm)	6/ctn
<b>1200</b>	6736UB	Gray Utility Box	11-1/8" x 5-3/4" x 5-1/4" (28.26 x 14.61 x 13.34 cm)	12-1/8" x 7-1/4" x 5-1/2" (30.80 x 18.42 x 13.97 cm)	Lid: 2-3/4" (6.99 cm) Base: 2-3/4" (6.99 cm)	6/ctn
<b>1400</b>	6742UB	Gray Utility Box	13.0" x 6.0" x 6-1/4" (33.02 x 15.24 x 15.88 cm)	14-3/8" x 8.0" x 7.0" (36.51 x 20.32 x 17.78 cm)	Lid: 3-1/2" (8.89 cm) Base: 3-1/2" (8.89 cm)	6/ctn
<b>1700</b>	6746UB	Gray Utility Box	15.0" x 6-3/4" x 6-1/2" (38.10 x 17.14 x 16.51 cm)	16-3/8" x 8-5/8" x 7.0" (41.59 x 21.91 x 17.78 cm)	Lid: 3-1/2" (8.89 cm) Base: 3-1/2" (8.89 cm)	4/ctn
<b>1800</b>	6752UB	Gray Utility Box: Has 3/16" (2.06 cm) Dia. Lock Tab	15-5/8" x 6-1/2" x 7-3/4" (39.69 x 16.51 x 19.69 cm)	17-1/2" x 10-1/4" x 8-1/2" (44.45 x 26.04 x 21.59 cm)	Lid: 4-1/4" (10.80 cm) Base: 4-1/4" (10.80 cm)	4/ctn
<b>2100</b>	6760UB	Gray Utility Box: Has 3/16" (2.06 cm) Dia. Lock Tab	17-1/8" x 8-5/8" x 9-1/4" (43.50 x 21.91 x 23.50 cm)	19.0" x 11-1/2" x 10-1/2" (48.26 x 29.21 x 26.67 cm)	Lid: 5-1/4" (13.34 cm) Base: 5-1/4" (13.34 cm)	2/ctn



**MADE IN U.S.A.**

*Distinctive Packaging For Quality Brands And Products™*





# Boxes with Lift-Out Trays and Lock Tabs



**14800-2**  
6744HS



**17800-2**  
6748HS



**19800-2**  
6757HS



**19804**  
6757TYS



**14800-2C**®  
6744HC

**Conductive Toolbox**

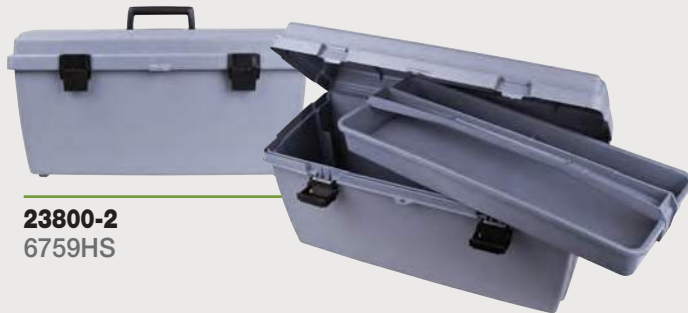

**23800-2**  
6759HS

## Utility Chest



**27800-2**  
6754TC

MODEL #	STOCK #	DESCRIPTION	DIMENS. (INSIDE: L x W x D)	DIMENS. (OUTSIDE: L x W x D)	LID, BASE DEPTH DIMENS.	TRAY DIMENS. L x W x D)	PACKED
<b>14800-2</b>	6744HS	Gray w/3/16" (2.06 cm) Diameter Lock Tab	13.0" x 5-3/8" x 4-1/4" (33.02 x 13.65 x 10.80 cm)	14-1/2" x 7-1/2" x 5-1/4" (36.83 x 19.05 x 13.34 cm)	Lid: 1-1/2" (3.81 cm) Base: 3-1/2" (8.89 cm)	12-1/4" x 4-3/4" x 1-1/2" (31.12 x 12.07 x 3.81 cm)	6/ctn
<b>17800-2</b>	6748HS	Gray w/3/16" (2.06 cm) Diameter Lock Tab	14-1/2" x 6-1/8" x 6.0" (36.83 x 15.56 x 15.24 cm)	16-5/8" x 8-3/4" x 7-1/8" (42.23 x 22.23 x 18.10 cm)	Lid: 2-1/8" (5.40 cm) Base: 4-3/4" (12.07 cm)	13-3/4" x 5-5/8" x 1-7/8" (34.93 x 14.29 x 4.76 cm)	4/ctn
<b>19800-2</b>	6757HS	Gray w/3/16" (2.06 cm) Diameter Lock Tab	18-1/8" x 6-1/2" x 7-1/8" (46.36 x 16.51 x 18.10 cm)	20-1/4" x 8-7/8" x 8-3/8" (51.44 x 22.54 x 21.27 cm)	Lid: 2-3/8" (6.03 cm) Base: 7.0" (17.78 cm)	17-5/8" x 6-3/8" x 2-3/16" (44.77 x 16.19 x 5.56 cm)	4/ctn
<b>19804</b>	6757TY	Yellow w/3/16" (2.06 cm) Diameter Lock Tab	18-1/8" x 6-1/2" x 7-1/8" (46.36 x 16.51 x 18.10 cm)	20-1/4" x 8-7/8" x 8-3/8" (51.44 x 22.54 x 21.27 cm)	Lid: 2-3/8" (6.03 cm) Base: 7.0" (17.78 cm)	17-5/8" x 6-3/8" x 2-3/16" (44.77 x 16.19 x 5.56 cm)	4/ctn
<b>23800-2</b>	6759HS	Gray w/3/16" (2.06 cm) Diameter Lock Tab	20-5/8" x 7-1/2" x 10.0" (52.39 x 19.05 x 25.40 cm)	23.0" x 10-1/2" x 11-3/8" (58.42 x 26.67 x 28.89 cm)	Lid: 2-1/2" (6.35 cm) Base: 8-3/8" (21.27 cm)	20-5/8" x 7-1/2" x 2.0" (52.39 x 19.05 x 5.08 cm)	2/ctn
<b>27800-2</b>	6754TC	Gray w/3/16" (2.06 cm) Diameter Lock Tab	23.0" x 12-1/2" x 12.0" (58.42 x 31.75 x 30.48 cm)	27-1/2" x 13-3/4" x 14.0" (69.85 x 35.93 x 35.56 cm)	Lid: 3-1/2" (8.89 cm) Base: 10-3/8" (26.35 cm)	11-1/2" x 2-1/4" x 11.0" (29.21 x 5.72 x 27.94 cm)	2/ctn

TOOLBOXES

### Low Boy™ Toolbox

This low profile Toolbox has an ergonomic handle and is manufactured from light-weight copolymer resins that are non-conductive, dent-proof, rust-proof and scratch-resistant.



**18192-2**  
6735HS

Description: Yellow  
 Interior Dimensions (L x W x D):  
 17.0" x 10-1/2" x 3-5/8" (43.18 x 26.67 x 9.21 cm)  
 Outside Dimensions (L x W x D):  
 18-1/2" x 12-1/2" x 6.0" (46.99 x 31.75 x 15.24 cm)  
 Packed: 4/ctn

### Expandable Building Box

Manufactured from light-weight copolymer resins that are non-conductive, dent-proof, rust-proof and scratch-resistant.

**Features:**

- Includes (2) 999-2 Infinite Divider System™ Boxes
- Additional trays available with Expansion Kit



**13900-2**  
6730HS

Description: Yellow and black  
 Interior Dimensions (L x W x D):  
 18.0" x 11.0" x 3-1/2" (45.72 x 27.94 x 8.89 cm)  
 Outside Dimensions (L x W x D):  
 18-1/2" x 12-1/2" x 11-3/4" (46.99 x 31.75 x 28.85 cm)  
 Packed: 4/ctn



**999-2**  
6726ID

Interior Dimensions (L x W x D):  
 13-1/8" x 8-7/8" x 1-15/16"  
 (33.34 x 22.54 x 4.92 cm)

### Expansion Kit

- Additional trays available with Expansion Kit



**13901-2**  
6731HS

Description: Expansion kit is black  
 Interior Dimensions (L x W x D):  
 13-1/2" x 9-1/4" x 2-3/4" (34.29 x 23.50 x 6.99 cm)  
 Outside Dimensions (L x W x D):  
 16-3/16" x 10-1/16" x 3-1/4" (41.12 x 25.56 x 8.26 cm)  
 Packed: 6/ctn

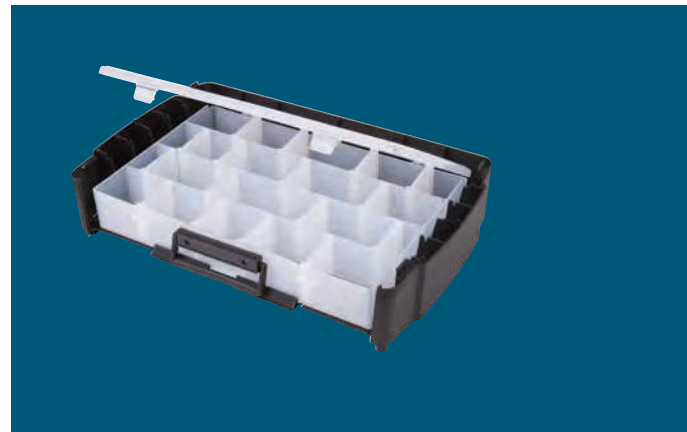

## Lil' Brute Toolbox

Super Satchel style handle with L-089 "quick-snap" latches. Available with or without lift-out tray (trays are not sold separately). Customize with colors or hot stamp options (see page 5). A fantastic value!



Description: Black with tray  
 Interior Dimensions (L x W x D):  
 12.0" x 4-3/4" x 4-3/4" (30.48 x 12.07 x 12.07 cm)  
 Outside Dimensions (L x W x D):  
 13.0" x 6.0" x 5-3/8" (33.02 x 15.24 x 13.65 cm)  
 Tray Dimensions (13805-2 only) (L x W x D):  
 12.0" x 4-3/8" x 1.0" (30.48 x 11.11 x 2.54 cm)  
 Lid: 1-1/2" (1.27 cm), Base: 4-1/4" (10.80 cm)  
 Packed: 6/ctn  
 (Tray not sold separately)

### With tray

**13805-2**  
6743HS



### Without tray

**13815-2**  
6742HS



## Utility Tote

- Copolymer resins resist rusting, fading and scratching
- Has a large built-in handle and pull-out tray on bottom can be opened from either side
- Ideal for service areas or vehicles
- Drawer with 12 compartments
  - Drawer dimensions L x W x D:  
13-3/4" x 9.0" x 1-1/2" (34.93 x 22.86 x 3.81 cm)



**16500-2**  
6769HS

Description: Black with light gray drawer  
 Interior Dimensions (L x W x D):  
 13-3/4" x 9.0" x 4.0" (34.93 x 22.86 x 10.16 cm)  
 Outside Dimensions (L x W x D):  
 16-5/8" x 10-1/4" x 6-7/8" (42.23 x 26.04 x 17.46 cm)  
 Packed: 6/ctn





# Boxes with Cantilever Trays

Rugged Utility Boxes featuring Tip Guard™ cantilever trays make it easy to organize tools and parts, repair kits, samples or sports equipment in a small space. Manufactured from light-weight copolymer resins that are dent-proof, rust-proof and scratch-resistant, as well as resistant to oils and most common chemicals.

### Features:

- Tough recessed handles
- Brass hinge and latch pins
- Positive-action latches
- Cantilever Tip-Guard tray supports
- Tongue-and-groove construction
- Light gray trays



**2-Tray Box**

**17090-2**  
6749HS

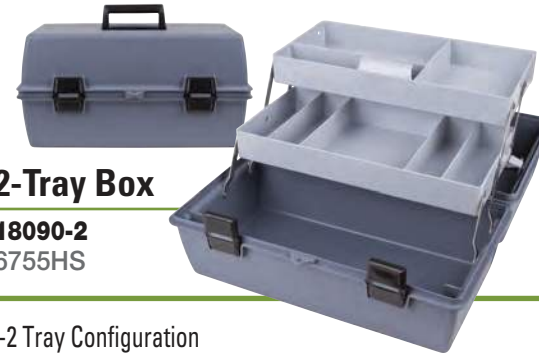

**2-Tray Box**

**18090-2**  
6755HS

17090-2 Tray Configuration

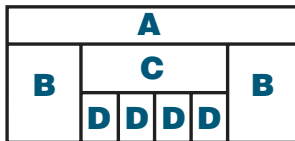

Top Tray (from front of box)



Bottom Tray (from front of box)

**17090-2**

Tray Compartments (Inside L x W x D):

- A**= 14-1/4" x 1-7/8" x 1-5/16" (36.20 x 4.76 x 3.33 cm)
- B**= 3-1/2" x 3-3/16" x 1-5/16" (8.89 x 8.10 x 3.33 cm)
- C**= 7.0" x 1-7/8" x 1-5/16" (17.78 x 4.76 x 3.33 cm)
- D**= 1-11/16" x 1-7/8" x 1-5/16" (4.29 x 4.76 x 3.33 cm)
- E**= 6.0" x 5-3/4" x 1-5/16" (15.24 x 14.61 x 3.33 cm)
- F**= 4.0" x 5-3/4" x 1-5/16" (10.16 x 14.61 x 3.33 cm)

18090-2 Tray Configuration

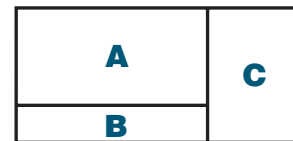

Top Tray (from front of box)



Bottom Tray (from front of box)

**18090-2**

Tray Compartments (Inside L x W x D):

- A**= 9.0" x 7.0" x 1-3/4" (22.86 x 17.78 x 4.45 cm)
- B**= 9.0" x 2-1/4" x 1-3/4" (22.86 x 5.72 x 4.45 cm)
- C**= 5-1/2" x 7.0" x 1-3/4" (13.97 x 17.78 x 4.45 cm)
- D**= 2-7/16" x 7.0" x 1-3/4" (6.19 x 17.78 x 4.45 cm)
- E**= 6-1/4" x 7.0" x 1-3/4" (15.88 x 17.78 x 4.45 cm)



## 6-Tray Box

**19060-2**  
6756HS



### 19060-2 Tray Configuration



Top Tray - Right Bank  
(from front of box)



Middle Tray - Right Bank  
(from front of box)



Bottom Tray - Right Bank  
(from front of box)



Top Tray - Left Bank  
(from front of box)



Middle Tray - Left Bank  
(from front of box)



Bottom Tray - Left Bank  
(from front of box)

### 19060-2

#### Tray Compartments (Inside L x W x D):

**A** = 14-1/2" x 2-3/4" x 1.0" (36.83 x 6.99 x 2.54 cm)

**B** = 1-3/4" x 2-3/4" x 1.0" (4.45 x 6.99 x 2.54 cm)

**C** = 1-7/8" x 2-7/8" x 1-5/16" (4.76 x 7.30 x 3.33 cm)

**D** = Slant Divider Wall: 12-1/2" x 1-5/8" and  
2-3/8" x 1-5/16" (31.75 x 4.13 x 6.03 x 3.33 cm)

**E** = 14-1/2" x 1-3/8" x 1-5/16" (36.83 x 3.49 x 3.33 cm)

**F** = 1-1/2" x 4-3/8" x 1-5/16" (3.81 x 11.11 x 3.33 cm)

**G** = 8-1/8" x 4-3/8" x 1-5/16" (20.64 x 11.11 x 3.33 cm)

MODEL #	STOCK #	DESCRIPTION	DIMENS. (INSIDE: L x W x D)	DIMENS. (OUTSIDE: L x W x D)	LID, BASE DEPTH DIMENS.	PACKED
<b>17090-2</b>	6749HS	Gray, 2 Cantilever Trays 11 Compartments	15.0" x 6-3/4" x 6-1/2" (38.10 x 17.15 x 16.51 cm)	16-3/8" x 8-5/8" x 7.0" (41.59 x 21.91 x 17.78 cm)	Lid: 3-1/2" (8.89 cm) Base: 3-1/2" (8.89 cm)	4/ctn
<b>18090-2</b>	6755HS	Gray, 2 Cantilever Trays 8 Compartments	15-5/8" x 6-1/2" x 7-3/4" (39.69 x 16.51 x 19.69 cm)	17-1/2" x 10-1/4" x 8-1/2" (44.45 x 26.04 x 21.59 cm)	Lid: 4-1/2" (10.80 cm) Base: 4-1/2" (10.80 cm)	4/ctn
<b>19060-2</b>	6756HS	Gray, 6 Cantilever Trays 35 Compartments	15-1/2" x 7-1/4" x 8-1/2" (39.37 x 18.42 x 21.59 cm)	18-1/2" x 10-3/4" x 10-3/8" (46.99 x 27.31 x 26.35 cm)	Lid: 4-3/4" (12.70 cm) Base: 4.0" (10.16 cm)	1/ctn

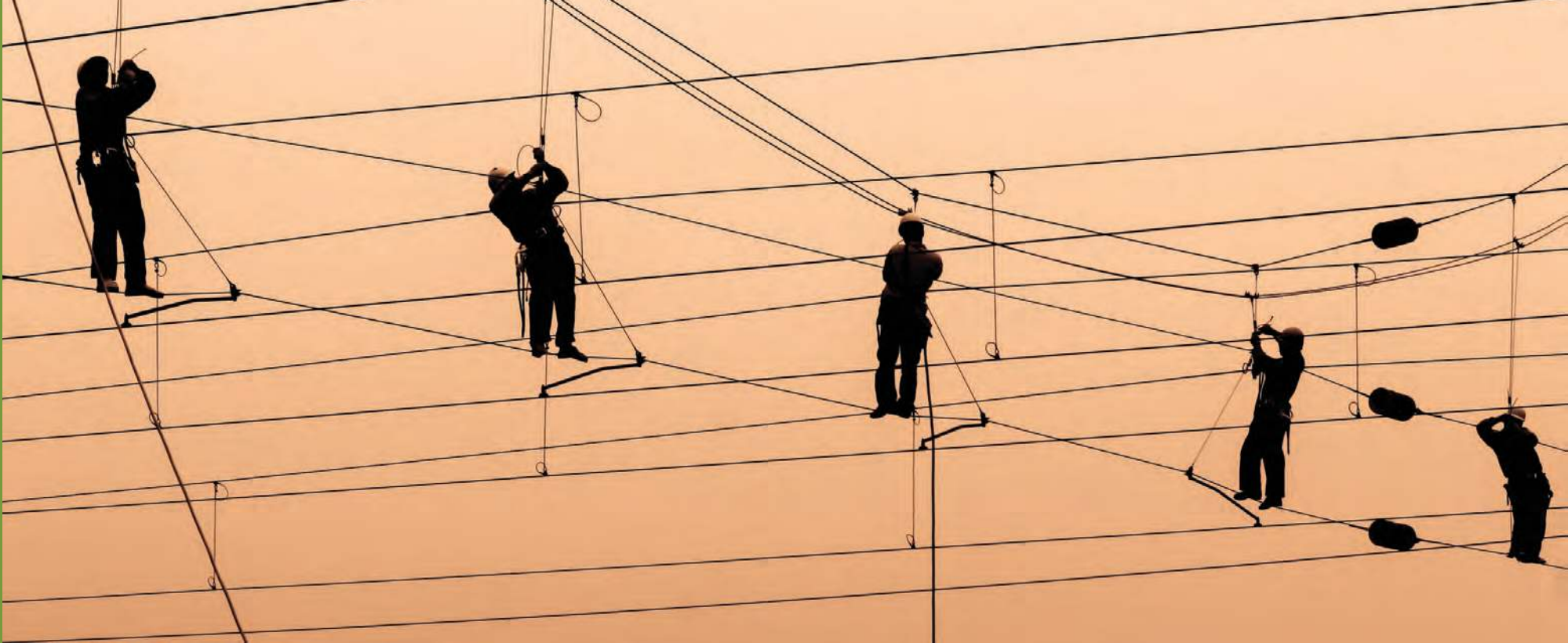

## Utility Bench Box

- Spacious 20" x 8" x 4" (50.8 x 20.32 x 10.16 cm) top
- Two large pull-out drawers with (2) compartments in drawer one and (2) compartments in drawer two
- Drawer dimensions are 18-3/8" x 5-7/8" x 1-7/8" (46.67 x 14.92 x 4.76 cm)
- Drawers can be secured from accidental opening
- Includes two (2) removable dividers for each drawer
- Fold-down handle

**21800-2**   
**6758HS**

Description: Black with (2) light gray drawers  
 Interior Dimensions (L x W x D):  
 20.0" x 8.0" x 4.0" (50.80 x 20.32 x 10.16 cm)  
 Outside Dimensions (L x W x D):  
 21-3/4" x 10-3/4" x 9-3/8" (55.25 x 27.31 x 23.81 cm)  
 Packed: 1/ctn





## Tool Chest

Flambeau Tool Chests are designed to organize, store and protect precision tools, hardware and small parts. They feature a unique front panel design that allows drawer access when the front panel is down. A unique lock prevents accidental spills and allows the lid and drawers to lift as a unit, providing access to the large lower storage area.

### Features:

- Resistant to most common chemicals, solvents & oils
- Lockable w/brass hinges and latch pins
- Molded in industrial-grade ABS plastic
- Large gray interchangeable drawers w/adjustable compartment sizes
- Positive-action latches

### 22030-2 6759CH

Description: Gray with (2) light gray drawers  
Outside Dimensions (L x W x D):  
19-1/2" x 11-1/2" x 11-3/4" (49.53 x 29.21 x 29.85 cm)  
Packed: 1/ctn

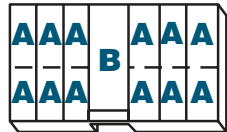

**22030-2  
Drawer B (#AR841-45):**  
L = 15-9/16" (39.53 cm),  
W = 8-13/16" (22.84 cm),  
D = 1-3/8" (3.49 cm)

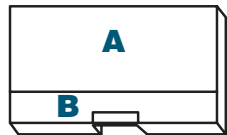

**22030-2  
Drawer F (#AR897-45):**  
L = 15-9/16" (39.53 cm),  
W = 8-13/16" (22.84 cm),  
D = 1-3/8" (3.49 cm)

**22030-2  
Drawer B Compartments (L x W x D):**  
**A** = 1-15/16" x 4-1/2" x 1-1/4" (4.92 x 11.43 x 3.18 cm),  
**B** = 3-3/16" x 8-7/8" x 1-1/4" (8.10 x 22.54 x 3.18 cm)

**22030-2  
Drawer B Compartments (L x W x D):**  
**A** = 15-1/8" x 6-3/16" x 1-1/4" (38.42 x 15.72 x 3.18 cm),  
**B** = 15-1/8" x 2-7/16" x 1-1/4" (38.42 x 6.19 x 3.18 cm)

## Tool Chests Replacement Drawer Packs

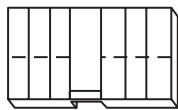

**Drawer B (#AR841-45):**  
L = 15-9/16" (39.53 cm),  
W = 8-13/16" (22.84 cm),  
D = 1-3/8" (3.49 cm)



**Drawer F (#AR869-45):**  
L = 15-9/16" (39.53 cm),  
W = 8-13/16" (22.84 cm),  
D = 1-3/8" (3.49 cm)

- Each replacement drawer pack includes (6) drawers

MODEL #	STOCK #	DESCRIPTION	PACKED
<b>AR841-45</b>	6069DP	<b>Drawer B</b>	6/ctn
<b>AR869-45</b>	6071DP	<b>Drawer C</b>	6/ctn

Dimensions listed are overall dimensions





## Big Mouth™ Toolbox

Flambeau Inc. is pleased to introduce the Big Mouth Toolbox to its Utility Toolbox line of products. This compact toolbox made of olive green polypropylene features increased base storage volume, carry handle, comfortable snap-shut latch and two lock holes for extra security.

The all-weather, oil-resistant construction, along with the water-resistant fit of the tongue-and-groove design between lid and base keep the contents secure and protected.

The Big Mouth Toolbox can also be customized by adding a company logo or a custom interior to provide your product or kit with a secure fit.

### Features:

- Increased base storage volume
- Proprietary all-weather, oil-resistant construction
- Tongue-and-groove design between the lid and base yields a water-resistant fit
- Carry handle
- Comfortable snap-shut latch
- (2) Lock holes for extra security

**NEW**

**6750HS**  
6750HS



Description: Olive green  
Interior Dimensions (L x W x D):  
7-1/2" x 4.0" x 3-1/4" (19.05 x 10.16 x 8.26 cm)  
Packed: 6/ctn



## Double Wall Small Toolbox

### Features:

- Lift-out tray sits on a “lip” at the top of the toolbox base
- Tray size is larger than bottom dimension of toolbox
- Injection mold latches
- Routed base for more storage space



**50042**  **E**  
50042

Interior Dimensions (L x W x D):  
15-1/2" x 4-3/4" x 4.0" (39.37 x 12.07 x 10.16 cm)  
Outside Dimensions (L x W x D):  
15-5/8" x 4-15/16" x 4-11/16" (39.69 x 12.54 x 11.91 cm)  
Tray Dimensions (L x W x D):  
16-5/8" x 4-15/16" x 1-1/4" (42.23 x 12.54 x 3.18 cm)  
Lid, base depth Dimensions:  
Lid: 1-7/8" (4.76 cm), Base: 2-13/16" (7.14 cm)  
Packed: 30/ctn



Lid: 1-7/8" (4.76 cm)

Base: 2-13/16" (7.14 cm)

Lockable



## Double Wall Large Toolbox

### Features:

- Lift-out tray sits on a “lip” at the top of the toolbox base
- Tray size is larger than bottom dimension of toolbox
- Injection mold handle with large integral latch
- Double wall construction for extra strength

**50043**  **E**  
50043

Interior Dimensions (L x W x D):  
18-1/4" x 7-1/2" x 5-3/4" (46.367 x 19.05 x 14.61 cm)  
Outside Dimensions (L x W x D):  
19-7/8" x 8-5/16" x 7.0" (50.48 x 21.11 x 17.78 cm)  
Tray Dimensions (L x W x D):  
16-5/8" x 4-15/16" x 1-1/4" (42.23 x 12.54 x 3.18 cm)  
Lid, base depth Dimensions:  
Lid: 3-1/2" (8.89 cm), Base: 3-1/2" (8.89 cm)  
Packed: 8/ctn



Lid: 3-1/2" (8.89 cm)

Base: 3-1/2" (8.89 cm)



\* **Express Service (E Symbol) items are for quantities 500 and less.**  
**For greater quantities call customer service: 1-800-344-5716.**



## Industrial Satchels: Large

Flambeau's Industrial Satchel Cases are ideal for maintenance, repair and operation (MRO) environments. These industrial satchels are built tough and designed to sort, store and organize nuts, bolts, fasteners and other maintenance items. Tinted lid provides excellent clarity. Base, dividers, handle and latches made with impact resistant polypropylene.

### Features:

- Can be customized (color and company logo)
- Rust-proof heavy-duty hinges

MODEL #	STOCK #	DESCRIPTION	DIMENS (OUTSIDE: L x W x D)	PACKED
<b>1016-2</b>	6745AB	Tinted Translucent Lid, 32 Compts, Includes 12 Removable Dividers*	18-1/2" x 13.0" x 3.0" (46.99 x 33.02 x 7.62 cm)	6/ctn
<b>1021-2</b>	6745AG	Tinted Translucent Lid, 21 Compartments	18-1/2" x 13.0" x 3.0" (46.99 x 33.02 x 7.62 cm)	6/ctn
<b>1024-2</b>	6745AA	Tinted Translucent Lid, 24 Compartments	18-1/2" x 13.0" x 3.0" (46.99 x 33.02 x 7.62 cm)	6/ctn
<b>1032-2</b>	6745AC	Tinted Translucent Lid, 32 Compts, Includes 24 Removable Dividers*	18-1/2" x 13.0" x 3.0" (46.99 x 33.02 x 7.62 cm)	6/ctn

\*Divider Packs Available (sold separately):

- 12pk of dividers for **1016-2** is order #**6014DP**. Bulk pks of dividers for **1016-2** is order #**601312**
- 12pk of dividers for **1032-2** is order #**6013DP**. Bulk pks of dividers for **1032-2** is order #**601303**

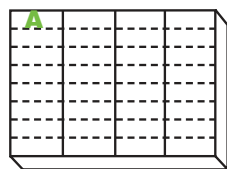

**(16) Compartments (L x W):**  
**A = 4.0" x 3.0" (10.16 x 7.62 cm)**

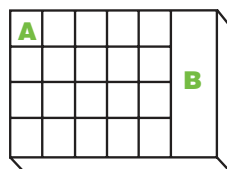

**(21) Compartments (L x W):**  
**A = 2-7/8" x 3.0" (7.30 x 7.62 cm)**  
**B = 4.0" x 13.0" (10.16 x 33.02 cm)**

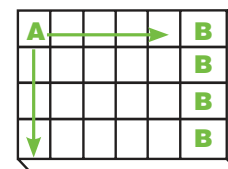

**(24) Compartments (L x W):**  
**A = 2-7/8" x 3.0" (7.30 x 7.62 cm)**  
**B = 4.0" x 3.0" (10.16 x 7.62 cm)**

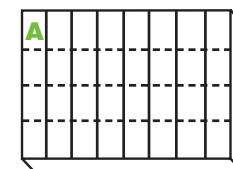

**(32) Compartments (L x W):**  
**A = 2-1/8" x 2-15/16" (5.40 x 7.46 cm)**

# Industrial Satchels: Small



**711-2**



Uses **Figure 1:**  
Compartment (L x W):

**A** = 14-5/8" x 10-1/8" (25.72 x 37.15 cm)

**724-2**

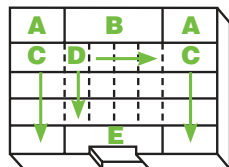

Uses **Figure 2:**  
Compartments (L x W):

**A** = 2-1/8" x 3-1/8" (5.40 x 7.94 cm),  
**B** = 2-1/8" x 8-1/8" (5.40 x 20.64 cm),  
**C** = 2.0" x 3-1/8" (5.08 x 7.94 cm),  
**D** = 2.0" x 2.0" (5.08 x 5.08 cm),  
**E** = 1-1/2" x 8-1/8" (3.81 x 20.64 cm)

**748-2**

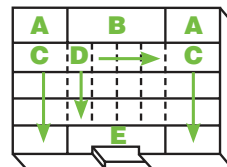

Uses (Top and bottom section) **Figure 2:**  
Compartments (L x W):

**A** = 2-1/8" x 3-1/8" (5.40 x 7.94 cm),  
**B** = 2-1/8" x 8-1/8" (5.40 x 20.64 cm),  
**C** = 2.0" x 3-1/8" (5.08 x 7.94 cm),  
**D** = 2.0" x 2.0" (5.08 x 5.08 cm),  
**E** = 1-1/2" x 8-1/8" (3.81 x 20.64 cm)

**725-2** <sup>®</sup>

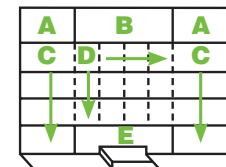

Uses (Top section) **Figure 2:**  
Compartments (L x W):

**A** = 2-1/8" x 3-1/8" (5.40 x 7.94 cm),  
**B** = 2-1/8" x 8-1/8" (5.40 x 20.64 cm),  
**C** = 2.0" x 3-1/8" (5.08 x 7.94 cm),  
**D** = 2.0" x 2.0" (5.08 x 5.08 cm),  
**E** = 1-1/2" x 8-1/8" (3.81 x 20.64 cm)

\*Divider Packs Available (sold separately):

• 12pk of dividers for **724-2**, **725-2** and **748-2** is order #6020DP. Bulk pkcs of dividers for **724-2**, **725-2** and **748-2** is order #602025

MODEL #	STOCK #	DESCRIPTION	DIMENS (OUTSIDE: L x W x D)	PACKED
<b>711-2</b>	6771UA	Tinted Translucent Lid, 1 Compartment	15-1/2" x 11-3/4" x 2-1/2" (39.37 x 28.85 x 6.35 cm)	12/ctn
<b>724-2</b>	6770PA	Tinted Translucent Lid, 9-24 Compts, 15 Removable Dividers	15-1/2" x 11-3/4" x 2-1/2" (39.37 x 28.85 x 6.35 cm)	12/ctn
<b>748-2</b>	6772AD	Double-Sided, Tinted Translucent Lid, 18-48 Compts, 30 Removable Dividers*	15-1/2" x 11-3/4" x 5.0" (39.37 x 28.85 x 12.70 cm)	6/ctn
<b>725-2</b>	6773AB	Double-Sided, Tinted Translucent Lid, 10-25 Compts, 15 Removable Dividers*	15-1/2" x 11-3/4" x 5.0" (39.37 x 28.85 x 12.70 cm)	6/ctn



Uses (Bottom section) **Figure 1:**  
Compartment (L x W):

**A** = 14-5/8" x 10-1/8" (25.72 x 37.15 cm)

# Slim, Deep and Double Deep Satchels

Used in many industries as a kit for replacement parts or as a salesperson's sidekick, you won't need to worry about being organized. All Super Satchels are made out of "Acid Free" translucent polypropylene with a positive contact latch system.



**T9100 6990TE**  
**Slim Super Satchel™**

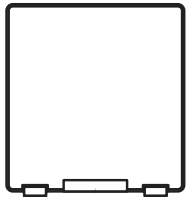

1 Compartment (L x W)



**T9101 6998TE**  
**Slim Super Satchel™**

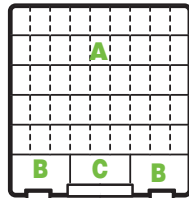

**8 Compartments (L x W):**  
**A** = 13-1/8" x 6-2.0" (33.34 x 5.08 cm),  
**B** = 3-3/4" x 3.0" (9.53 x 7.62 cm),  
**C** = 5-1/2" x 2-3/4" (13.97 x 6.99 cm)



**T9101AT 6999TE**  
**Slim Super Satchel™ w/Anti-Tarnish**

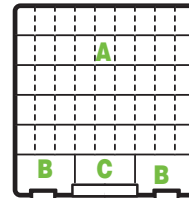

**8 Compartments (L x W):**  
**A** = 13-1/8" x 6-2.0" (33.34 x 5.08 cm),  
**B** = 3-3/4" x 3.0" (9.53 x 7.62 cm),  
**C** = 5-1/2" x 2-3/4" (13.97 x 6.99 cm)



**T9001 6991TE**  
**Deep Super Satchel™**

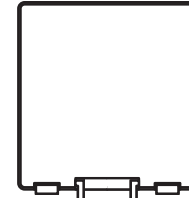

1 Compartment (L x W)

\* Please Note: additional divider packs sold separately on (page 7)

MODEL #	STOCK #	DESCRIPTION	DIMENS. (INSIDE: L x W x D)	DIMENSIONS (OUTSIDE: L x W x D)	DIVIDERS #	BULK ORDER #	PACKED
<b>T9100</b>	6990TE	1 Compartment with Black Latches	13-1/8" x 13-1/8" x 1-3/4" (33.34 x 33.34 x 4.45 cm)	14.0" x 15.0" x 2.0" (35.56 x 38.10 x 5.08 cm)	-	-	6/ctn
<b>T9101</b>	6998TE	8 Compartments, Black Latches and 20 Removable Dividers*	13-1/8" x 13-1/8" x 1-3/4" (33.34 x 33.34 x 4.45 cm)	14.0" x 15.0" x 2.0" (35.56 x 38.10 x 5.08 cm)	<b>5712DP</b>	<b>601365</b>	6/ctn
<b>T9101AT</b>	6999TE	8 Compartments, Silver Latches and 20 Removable Anti-Tarnish Dividers*	13-1/8" x 13-1/8" x 1-3/4" (33.34 x 33.34 x 4.45 cm)	14.0" x 15.0" x 2.0" (35.56 x 38.10 x 5.08 cm)	<b>5812DP</b>	-	6/ctn
<b>T9001</b>	6991TE	1 Compartment w/Black Handle & Latches	13-1/8" x 13-1/8" x 3.0" (33.34 x 33.34 x 7.62 cm)	14.0" x 15.0" x 3-1/2" (35.56 x 38.10 x 8.89 cm)	-	-	6/ctn



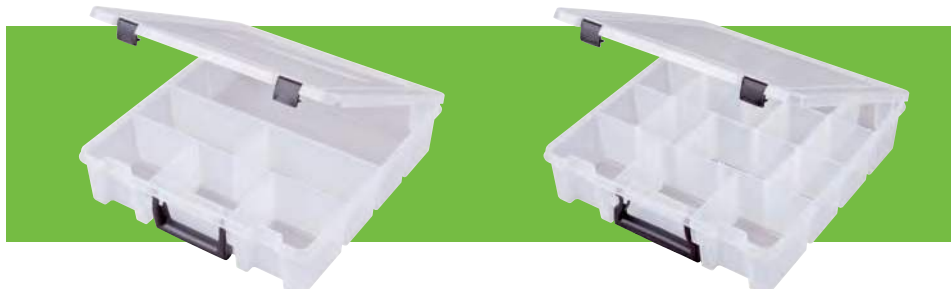

**T9006 6996TE**  
**Deep Super Satchel™**

**T9007 6997TE**  
**Deep Super Satchel™**



**T9200 6784TE**  
**Double Deep™ Super Satchel™**

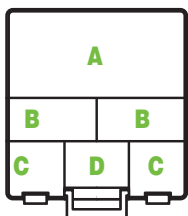

**6 Compartments (L x W):**  
**A** = 13-1/8" x 6-1/2" (33.34 x 16.51 cm),  
**B** = 6-1/2" x 3.0" (16.51 x 7.62 cm),  
**C** = 4-1/8" x 3.0" (10.48 x 7.62 cm),  
**D** = 4-1/2" x 3-1/8" (11.43 x 7.94 cm)

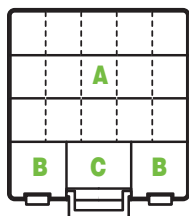

**6 Compartments (L x W):**  
**A** = 13-1/8" x 3-1/8" (33.34 x 7.93 cm),  
**B** = 4-1/4" x 3-3/4" (10.79 x 9.52 cm),  
**C** = 4-1/2" x 3-3/4" (11.43 x 9.52 cm)

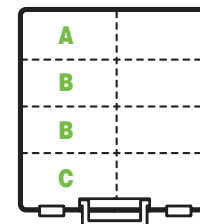

**T9200 Double Deep Super Satchel (L x W):**  
**A** = (1 row of 2 compts) 6-1/4" x 3.0" (15.88 x 7.62 cm),  
**B** = (2 rows of 4 compts) 6-1/4" x 3-1/4" (15.88 x 8.26 cm),  
**C** = (1 row of 2 compts) 6-1/4" x 2-3/4" (15.88 x 6.99 cm)

MODEL #	STOCK #	DESCRIPTION	DIMENS. (INSIDE: L x W x D)	DIMENSIONS (OUTSIDE: L x W x D)	DIVIDERS #	BULK ORDER #	PACKED
<b>T9006</b>	6996TE	6 Compartments, Black Handle and Latches	13-1/8" x 13-1/8" x 3.0" (33.34 x 33.34 x 7.62 cm)	14.0" x 15.0" x 3-1/2" (35.56 x 38.10 x 8.89 cm)	-	-	6/ctn
<b>T9007</b>	6997TE	6 Compts, Black Handle and Latches and 12 Removable Dividers*	13-1/8" x 13-1/8" x 3.0" (33.34 x 33.34 x 7.62 cm)	14.0" x 15.0" x 3-1/2" (35.56 x 38.10 x 8.89 cm)	<b>9012DP</b>	<b>601372</b>	6/ctn
<b>T9200</b>	6784TE	Black Handle and Latches and 7 Removable Dividers*	15-1/4" x 14.0" x 6-1/125" (38.74 x 35.56 x 15.56 cm)	15-7/32" x 14-5/32" x 6-7/32" (38.66 x 35.96 x 15.80 cm)	-	<b>600513</b>	3/ctn

\*Please Note: additional divider packs sold separately on (page 7)

# Deluxe Super Satchel™

Like the Slim, Deep and Double Deep, the Deluxe Super Satchels are made out of "Acid Free" translucent polypropylene with a positive contact latch system.



**T9500 6787TE**

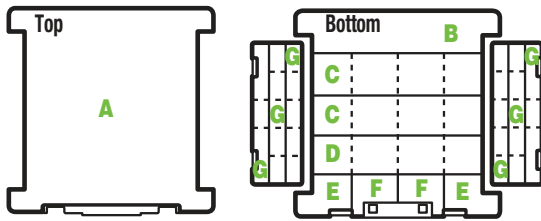

**Up to (24) Compartments (L x W):**

- A** = 13-1/4" x 15-1/8" (33.66 x 38.42 cm),
- B** = 13-1/2" x 3-1/8" (34.29 x 7.94 cm),
- C** = (2 rows of 4 compts) 2-7/8" x 3-1/8" (7.30 x 7.94 cm),
- D** = (1 rows of 4 compts) 2-7/8" x 3-1/4" (7.30 x 8.26 cm)
- E** = (2 compts) 3.0" x 2-1/2" (7.62 x 6.35 cm),
- F** = (2 compts) 2-1/4" x 3-5/8" (5.72 x 9.21 cm),
- G** = (3 rows of 15 compts/each side) 2-1/4" x 1-1/8" (5.71 x 2.86 cm)



**T9501 6788TE**

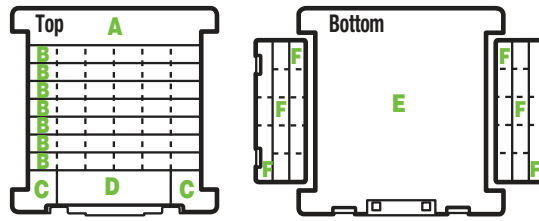

**Up to (73) Compartments (L x W):**

- A** = 13-1/4" x 2-3/4" (33.66 x 6.99 cm),
- B** = (7 rows of 42 compts) 13-1/4" x 1-1/4" (33.66 x 3.18 cm),
- C** = (2 compts) 2.0" x 2-5/8" (5.08 x 6.67 cm),
- D** = (1 compts) 9.0" x 2-3/4" (22.86 x 6.99 cm)
- E** = 13-1/4" x 5-1/2" (33.66 x 38.74 cm),
- F** = (3 rows of 15 compts/each side) 2-1/4" x 1-1/8" (5.71 x 2.86 cm)



**T9502 6789TE**

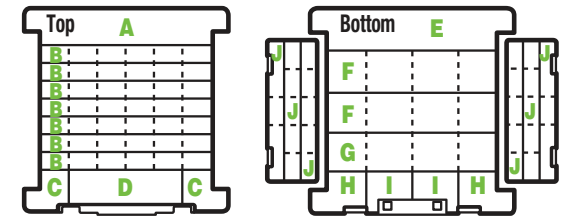

**Up to (89) Compartments (L x W):**

- A** = 13-1/4" x 2-3/4" (33.66 x 6.99 cm),
- B** = 13-1/4" x 1-1/4" (33.66 x 3.18 cm),
- C** = 2.0" x 2-5/8" (5.08 x 6.67 cm),
- D** = 9.0" x 2-3/4" (22.86 x 6.99 cm)
- E** = 13-1/2" x 3-1/8" (34.29 x 7.94 cm),
- F** = (2 rows of 4 compts) 2-7/8" x 3-1/8" (7.30 x 7.94 cm),
- G** = (1 row of 4 compts) 2-7/8" x 3-1/4" (7.30 x 8.26 cm),
- H** = (2 compts) 3.0" x 2-1/2" (7.62 x 6.35 cm),
- I** = (2 compts) 2-1/4" x 3-5/8" (5.72 x 9.21 cm),
- J** = (3 rows of 15 compts/each side) 2-1/4" x 1-1/8" (5.71 x 2.86 cm)

\*Please Note: additional divider packs sold separately on (page 7)

MODEL #	STOCK #	DESCRIPTION	DIMENSIONS (OUTSIDE: L x W x D)	PACKED
<b>T9500</b>	6787TE	Translucent, Black Handle and Latches Open Top / Divided Bottom, Includes Removable Dividers*	17-1/4" x 16-3/4" x 5.0" (43.82 x 42.55 x 12.70 cm)	3/ctn
<b>T9501</b>	6788TE	Translucent, Black Handle and Latches Divided Top / Open Bottom, Includes Removable Dividers*	17-1/4" x 16-3/4" x 5.0" (43.82 x 42.55 x 12.70 cm)	3/ctn
<b>T9502</b>	6789TE	Translucent, Black Handle and Latches Divided Top / Divided Bottom, Includes Removable Dividers*	17-1/4" x 16-3/4" x 5.0" (43.82 x 42.55 x 12.70 cm)	3/ctn

## IDS™ Cabinets - (Infinite Divider Storage™ System)

A hybrid between mobile and stationary storage, these cabinets have interlocking grooves for easy and secure stacking. The IDS™ system truly gives you mastery over your storage space with (5) IDS translucent boxes featuring dividers that can be placed every 1/16" (0.16 cm) throughout the compartments!

### Features:

- Infinite Divider System™ (IDS)
- Resistant to oil & common chemicals
- Interlocking stackable cabinets
- Dent-proof
- Fully extendable drawers
- Removable cases



Dividers can be placed at 1/16" (0.16 cm) increments throughout the entire box

**T900**  
6725ID



**IDS Box** (Inside L x W x D):  
13-1/8" x 8-7/8" x 1-15/16" (33.34 x 22.54 x 4.92 cm)

**999-2**  
6726ID

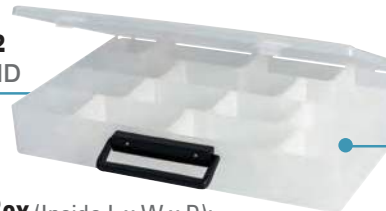

**IDS Box** (Inside L x W x D):  
13-1/8" x 8-7/8" x 1-15/16" (33.34 x 22.54 x 4.92 cm)



**8500NT**  
8500NT



**8500ST**  
8500ST



**8500JT**  
8500JT



Special interlocking grooves on the cabinets allow them to be stacked on top of each other.

MODEL #	STOCK #	DESCRIPTION	DIMENS. (OUTSIDE: L x W x D)	PACKED
<b>8500NT</b>	8500NT	Cabinet with (5) Trays, No Boxes	15-1/4" x 14-3/4" x 16.0" (38.74 x 37.47 x 40.64 cm)	1/ctn
<b>8500ST</b>	8500ST	Cabinet with (5) Trays and (5) T900 Boxes T900 Boxes Come with (16) IDS™ Dividers	15-1/4" x 14-3/4" x 16.0" (38.74 x 37.47 x 40.64 cm)	1/ctn
<b>8500JT</b>	8500JT	Cabinet with (5) Trays and (5) 999-2 Boxes 999-2 Boxes Come with (16) IDS Dividers	15-1/4" x 14-3/4" x 16.0" (38.74 x 37.47 x 40.64 cm)	1/ctn

\*See Compartment Box section (pages 130 - 131) for additional boxes that will work within these cabinets. Check (page 7) for replacement IDS Dividers



Drawer Cabinets



**2275-2**  
6763DB



**2276-2**  
6764DB



**2277-2**  
6765DB

Flambeau® Drawer Cabinets are designed to organize, store and protect precision tools, hardware and small parts. Featuring a self-storing door panel providing all-weather protection for the contents inside.

**Features:**

- Industrial grade ABS plastic
- Resistant to most common chemicals, solvents and oils
- Lockable with positive-action latches
- Brass hinges and latch pins



Know exactly where you can get your hands on your hardware when you store it in this box!

## Drawer Cabinets Drawer Dimensions

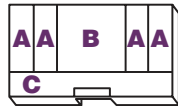

**Drawer A (#AR839-45): Drawer A Compartments (L x W x D):**  
 L = 15-9/16" (39.53 cm),  
 W = 8-13/16" (22.84 cm),  
 D = 1-3/8" (3.49 cm)  
**A** = 1-15/16" x 6-3/16" x 1-1/4" (4.92 x 15.72 x 3.18 cm),  
**B** = 7-5/16" x 6-3/16" x 1-1/4" (18.57 x 15.72 x 3.18 cm),  
**C** = 15-1/8" x 2-7/16" x 1-1/4" (5.08 x 7.94 x 3.18 cm)

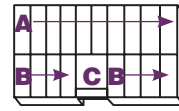

**Drawer D (#AR839-45): Drawer D Compartment (L x W x D):**  
 L = 15-9/16" (39.53 cm),  
 W = 8-13/16" (22.84 cm),  
 D = 1-3/8" (3.49 cm)  
**A** = 1-3/8" x 5-1/16" x 1-1/4" (3.49 x 12.86 x 3.18 cm),  
**B** = 1-3/8" x 3-9/16" x 1-1/4" (3.49 x 9.05 x 3.18 cm),  
**C** = 3-3/16" x 3-9/16" x 1-1/4" (8.10 x 9.05 x 3.18 cm)

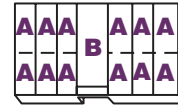

**Drawer B (#AR841-45): Drawer B Compartments (L x W x D):**  
 L = 15-9/16" (39.53 cm),  
 W = 8-13/16" (22.84 cm),  
 D = 1-3/8" (3.49 cm)  
**A** = 1-15/16" x 4-1/2" x 1-1/4" (4.92 x 11.43 x 3.18 cm),  
**B** = 3-3/16" x 8-7/8" x 1-1/4" (8.10 x 22.54 x 3.18 cm)



**Drawer E (#AR841-45): Drawer E Compartment (L x W x D):**  
 L = 15-9/16" (39.53 cm),  
 W = 8-13/16" (22.84 cm),  
 D = 4-7/16" (11.27 cm)  
**A** = 15-1/8" x 8-5/8" x 4-5/16" (38.42 x 21.91 x 10.95 cm)



**Drawer C (#AR869-45): Drawer C Compartment (L x W x D):**  
 L = 15-9/16" (39.53 cm),  
 W = 8-13/16" (22.84 cm),  
 D = 2-7/8" (7.30 cm)  
**A** = 15-1/8" x 8-5/8" x 2-5/8" (38.42 x 21.91 x 6.67 cm)



**Drawer F (#AR869-45): Drawer F Compartment (L x W x D):**  
 L = 15-9/16" (39.53 cm),  
 W = 8-13/16" (22.84 cm),  
 D = 1-3/8" (3.49 cm)  
**A** = 15-1/8" x 6-3/16" x 1-1/4" (38.42 x 15.72 x 3.18 cm),  
**B** = 15-1/8" x 2-7/16" x 1-1/4" (38.42 x 6.19 x 3.18 cm)

MODEL #	STOCK #	DESCRIPTION	DIMENS. (OUTSIDE: L x W x D)	DRAWER CONFIGURATIONS	PACKED
<b>22060</b> (Not shown)	6596DH	Gray with Light Gray Drawers	19-1/2" x 11-1/2" x 11-3/4" (49.53 x 29.21 x 29.85 cm)	<b>(4) B, (1) C and (1) F</b>	1/ctn
<b>2275-2</b>	6763DB	Gray with Light Gray Drawers	19-1/2" x 10-3/8" x 15.0" (49.53 x 26.35 x 38.10 cm)	<b>(2) B, (2) D and (1) E</b>	1/ctn
<b>2276-2</b>	6764DB	Gray with Light Gray Drawers	19-1/2" x 10-3/8" x 15.0" (49.53 x 26.35 x 38.10 cm)	<b>(1) A, (3) B, (1) C and (1) D</b>	1/ctn
<b>2277-2</b>	6765DB	Gray with Light Gray Drawers	19-1/2" x 10-3/8" x 15.0" (49.53 x 26.35 x 38.10 cm)	<b>(1) A, (2) B, and (4) D</b>	1/ctn

Dimensions listed are overall dimensions

## Drawer Cabinets Replacement Drawer Packs

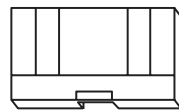

**Drawer A (#AR839-45):**  
 L = 15-9/16" (39.53 cm),  
 W = 8-13/16" (22.84 cm),  
 D = 1-3/8" (3.49 cm)

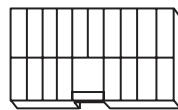

**Drawer D (#AR839-45):**  
 L = 15-9/16" (39.53 cm),  
 W = 8-13/16" (22.84 cm),  
 D = 1-3/8" (3.49 cm)

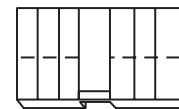

**Drawer B (#AR841-45):**  
 L = 15-9/16" (39.53 cm),  
 W = 8-13/16" (22.84 cm),  
 D = 1-3/8" (3.49 cm)



**Drawer E (#AR841-45):**  
 L = 15-9/16" (39.53 cm),  
 W = 8-13/16" (22.84 cm),  
 D = 4-7/16" (11.27 cm)

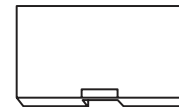

**Drawer C (#AR869-45):**  
 L = 15-9/16" (39.53 cm),  
 W = 8-13/16" (22.84 cm),  
 D = 2-7/8" (7.30 cm)

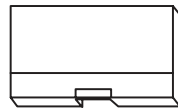

**Drawer F (#AR869-45):**  
 L = 15-9/16" (39.53 cm),  
 W = 8-13/16" (22.84 cm),  
 D = 1-3/8" (3.49 cm)

• Each replacement drawer pack includes (6) drawers

MODEL #	STOCK #	DESCRIPTION	PACKED
<b>AR839-45</b>	6073DP	<b>Drawer A</b>	6/ctn
<b>AR841-45</b>	6069DP	<b>Drawer B</b>	6/ctn
<b>AR869-45</b>	6071DP	<b>Drawer C</b>	6/ctn
<b>AR840-45</b>	6072DP	<b>Drawer D</b>	6/ctn
<b>AR928-45</b>	6060DP	<b>Drawer E</b>	6/ctn
<b>AR897-45</b>	6070DP	<b>Drawer F</b>	6/ctn



## Parts Station Storage Cabinets

High-density storage, maximum organization and cost savings efficiency can be achieved with our generous selection of reinforced durable plastic frame storage cabinets. Each drawer cabinet features terpolymer translucent drawers & drawer stops to prevent accidental spills



Dividers

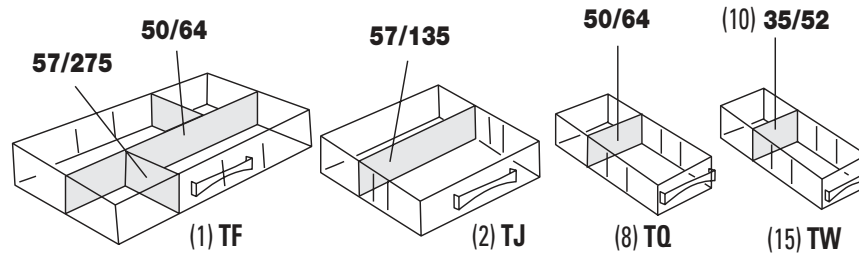
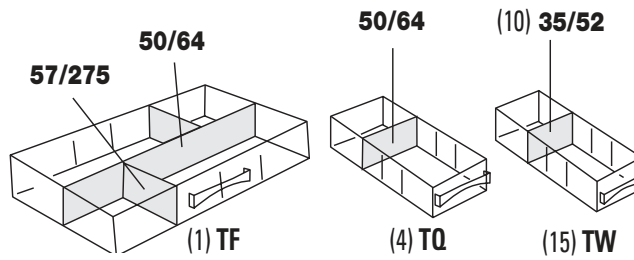

MODEL #	STOCK #	DESCRIPTION	USES DIVIDER #	DIMENS. (OUT: L x W x H)	PACKED
<b>C20P</b>	6575PC	Gray Clear Terpolymer Drawers Clear Terpolymer Dividers	* (10) <b>35/52</b> <b>50/64</b> <b>57/275</b>	12.0" x 6-1/4" x 11-1/4" (30.48 x 15.88 x 28.58 cm)	4/ctn
<b>C26P</b>	6576PC	Gray Clear Terpolymer Drawers Clear Terpolymer Dividers	* (10) <b>35/52</b> <b>50/64</b> <b>57/135</b> <b>57/275</b>	12.0" x 6-1/4" x 16-1/2" (30.48 x 15.88 x 41.91 cm)	4/ctn
<b>U30P</b>	6573PC	Gray Clear Terpolymer Drawers Clear Terpolymer Dividers	* (10) <b>35/52</b>	12.0" x 6-1/4" x 11-1/4" (30.48 x 15.88 x 28.58 cm)	4/ctn
<b>U45P</b>	6574PC	Gray Clear Terpolymer Drawers Clear Terpolymer Dividers	* (10) <b>35/52</b>	12.0" x 6-1/4" x 16-1/2" (30.48 x 15.88 x 41.91 cm)	4/ctn

\* All cabinets include (10) 35/52 dividers, all other dividers are optional



**C20P**



**C26P**



**U30P**



**U45P**

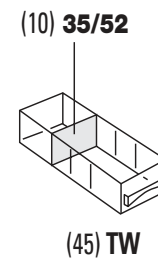
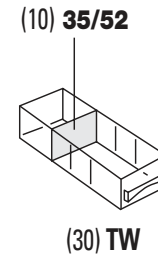



## Stand 'N Store™

A cross between a tool box and a step stool, the Stand 'N Store™ makes a great companion for tool portability and that often needed "little extra reach" on any job site.

### Features:

- Engineered to support 305 pounds (136.08 kg)
- Heavy-duty riveted fold-down handle
- Lift-out center tray

**22500-3**  
6759TC

Description: Safety Yellow  
Interior Dimensions (L x W x D):  
15-1/2" x 9.0" x 7-1/2"  
(39.37 x 22.86 x 19.05 cm)  
Tray Dimensions (L x W x D):  
14.0" x 8-1/4" x 1-5/8"  
(35.56 x 20.96 x 4.13 cm)  
Packed: 2/ctn



They're Stackable!

## Expandable Tube

### Features:

- Contoured, blow mold construction - won't bend, crush or break
- Hinged door makes it easy to load and unload
- Mold-in handle for maximum durability
- Completely lockable for added security
- Telescopes from 63" (160.02 cm) to 87" (220.99 cm) for maximum versatility

**50077**®  
50077

Description: Black, Expandable  
Outside Dimensions (L x W x D):  
5.0" Diameter, 63" Collapsed  
(12.70 Dia., 160.02 cm)  
Telescope Range:  
63.0" to 87.0"  
(160.02 to 220.99 cm)  
Packed: 1/ctn

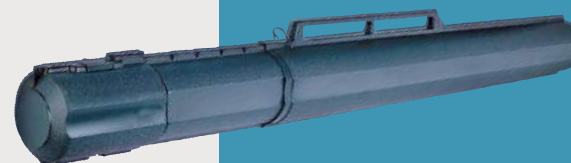

Collapsed

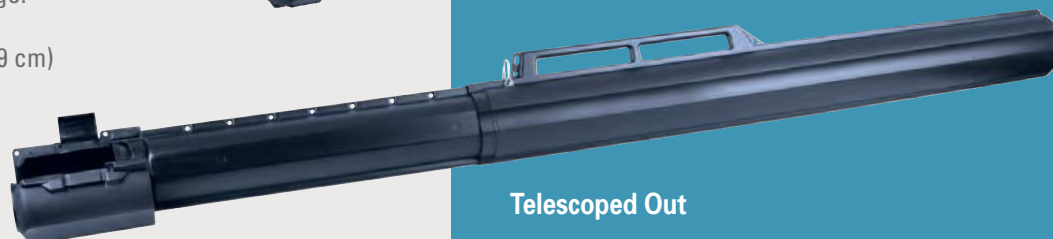

Telescoped Out

## Utility Workstation™ Cart

Stress tested for weight up to 300 pounds (136.08 kg), easily integrate this cart into almost any application. Many other Flambeau products can be integrated into this Workstation to increase your organization and efficiency. Can be customized with your company name or logo. Easy assembly.

### Features:

- Heavy-duty locking casters
- Ergonomic handle with tool receiver hold up
- Sliding removable lid and bin rail
- Locking tabs for lid
- Customizable logo area
- Drain plugs in each tray

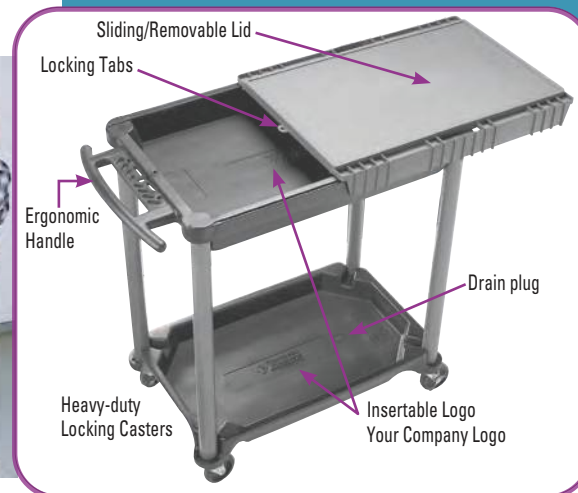

MODEL #	STOCK #	DESCRIPTION	OVERALL DIMENSIONS (L x W x D)	PACKED	
<b>8510ST</b>	8510ST	Two-Tone Gray	43.0" x 21.0" x 38.0" (109.22 x 55.55 x 99.06 cm)	1/ctn	
		DIMENSIONS (INSIDE TRAY: L x W x D)	DIMENSIONS (BOTTOM TRAY: L x W x D)	DIMENSIONS (WORK SURFACE: L x W)	LOGO AREA
		25-1/2" x 18.0" x 3-5/25" (64.77 x 45.72 x 8.13 cm)	20.0" x 17.0" x 3.0" (50.80 x 43.18 x 7.62 cm)	29-1/2" x 21" (72.39 x 19.05 cm)	14.0" x 3-1/4" (35.56 x 8.25 cm)

## Bin Storage Systems

Mix & match our four (4) sizes of bins to your liking. Our polypropylene bins are extra heavy-duty and can be stacked or wall-mounted with a rail. Our bins are impervious to rust, oil and most common chemicals.

### Features:

- Stackable and mountable
- Can be used with the Utility Workstation™ (see above)



MODEL #	STOCK #	DESCRIPTION	DIMENS (INSIDE L x W x D)	PACKED
<b>60R</b>	6794RB	Red	4-1/4" x 4.0" x 1-1/2" (10.80 x 10.16 x 3.81 cm)	24/ctn
<b>60B</b>	6794BB	Blue		
<b>60Y</b>	6794YB	Yellow		
<b>120R</b>	6795RB	Red	4-1/4" x 5.0" x 2-1/2" (10.80 x 12.70 x 6.35 cm)	24/ctn
<b>120B</b>	6795BB	Blue		
<b>120Y</b>	6795YB	Yellow		
<b>240R</b>	6796RB	Red	4-1/4" x 6-1/2" x 3-1/4" (10.80 x 16.51 x 8.26 cm)	12/ctn
<b>240B</b>	6796BB	Blue		
<b>240Y</b>	6796YB	Yellow		
<b>480R</b>	6797RB	Red	4-1/4" x 8-3/4" x 5-1/4" (10.80 x 22.23 x 13.34 cm)	12/ctn
<b>480B</b>	6797BB	Blue		
<b>480Y</b>	6797YB	Yellow		

**351BA** 6794BA • Set of (16) **60Y**, (24) **120R**, (24) **120R**, (24) **240Y** & (16) **480B**  
**Bin Set**  
 • Packed: 1/ctn



Conductive Bins are also available upon request

\* Width is measured from back to front straight edge before flare out

## Rolling Tote Storage Cabinet

The Rolling Tote Storage Cabinet is designed for light commercial parts storage and transport. Excellent for storing and transporting hand held tools, MRO items, or single unit storage for multiple uses. Features side extension pull handle with grip and lift out removable tray including lid stays. The large interior storage area, approximately 31" x 20" provides ample area to organize.

### Features:

- Padded steel pull handle for easy transport
- Includes removable tray
- Weight: 23.0 lbs per carton / cu/carton: 6-3/4" (17.14 cm)
- Lid can be used as a work surface

Great for outdoor gear and more!



### 6531BK 6531BK

Description:  
Black with Metal Latches  
Inside Dimensions (L x W x D):  
25.0" x 13-3/4" x 15-3/4"  
(63.5 x 34.92 x 40.0 cm)  
Outside Dimensions (L x W x D):  
29-1/2" x 18-1/2" x 19-1/2"  
(74.93 x 47.0 x 49.53 cm)  
Packed: 1/ctn





# Carry Packs™

From the shelf or wall (mountable), this system gives you the high-density storage and organization you need and the freedom to easily get your parts to the work site.

### Features:

- Boxes lock in place for ease of folding and carrying
- Each box can be quickly disengaged for part access
- Carry Pack frames are available with or without boxes

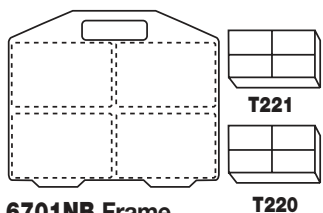

6701NB Frame

Additional boxes that fit:  
**20220-2**  
**A220 A221**  
**A226 A228**  
**K220 K226**  
**M220 M221**

**20220-2**  
 Includes (2) **T220** & **T221**  
 trans. polypropylene boxes

**T220 and T221**  
 Dimens: (LxWxD)  
 4-3/8" x 2-5/8" x 1.0"  
 (11.11 x 6.67 x 2.54 cm)

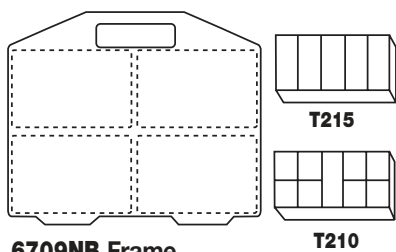

6709NB Frame

Additional boxes that fit:  
**21221-2**  
**A210 A211**  
**A212 A213**  
**A214 A215**  
**K210 K215**  
**K216 M210**  
**M215 T219**

**21210-2**  
 Includes (2) **T210** & **T215**  
 trans. polypropylene boxes

**T210 and T215**  
 Dimens: (LxWxD)  
 6-3/4" x 3-3/16" x 1-3/16"  
 (17.15 x 8.10 x 3.02 cm)

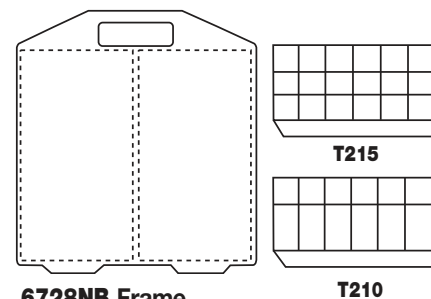

6728NB Frame

Additional boxes that fit:  
**21600-2**  
**A602 A603**  
**A606 A607**  
**A610 A613**  
**K601 K602**  
**K606 K607**  
**K616R K618**  
**M602 M606**  
**M612 T606**  
**T616R**

**21600-2**  
 Includes (2) **T612** & **T618**  
 trans. polypropylene boxes

**T612 and T618**  
 Dimens: (LxWxD)  
 10-1/2" x 6-3/16" x 1-9/16"  
 (26.67 x 15.72 x 3.97 cm)

\* Additional boxes sold separately

\*See Compartment Box section (pages 96 - 135) for additional boxes

MODEL #	STOCK #	DESCRIPTION	OVERALL DIMENS. (OUTSIDE: L x W x D)	PACKED
<b>20220-2</b> ☺	6701VU	Includes (2) <b>T220</b> & <b>T221</b> Boxes	9-3/4" x 8-3/4" x 1-1/2" (24.77 x 22.23 x 3.81 cm)	6/ctn
<b>6701NB</b> ☺	6701NB	<b>Frame Only</b>	9-3/4" x 8-3/4" x 1-1/2" (24.77 x 22.23 x 3.81 cm)	6/ctn
<b>21210-2</b>	6709VU	Includes (2) <b>T210</b> & <b>T215</b> Boxes	14-1/4" x 10-3/4" x 1-1/2" (36.20 x 27.31 x 3.81 cm)	6/ctn
<b>6709NB</b> ☺	6709NB	<b>Frame Only</b>	14-1/4" x 10-3/4" x 1-1/2" (36.20 x 27.31 x 3.81 cm)	6/ctn
<b>21600-2</b> ☺	6728VU	Includes (2) <b>T612</b> & <b>T618</b> Boxes	13-7/16" x 13-1/2" x 2-1/8" (34.13 x 34.29 x 5.40 cm)	6/ctn
<b>6728NB</b> ☺	6728NB	<b>Frame Only</b>	13-7/16" x 13-1/2" x 2-1/8" (34.13 x 34.29 x 5.40 cm)	6/ctn



21210-2 folded and side view

# MEDICAL STORAGE



Our medical line is light-weight, rust-proof, scratch and chemical-resistant. Flambeau® medical cases, chests, and instrument boxes are built to last with extra thick walls for long-lasting durability and impact resistance. Used by EMS personnel, triage staff, first-responders and other respected medical professionals around the globe, our variety of products will meet your needs.

#### Features:

- Autoclave safe (select items)
- Locking tabs (select items)
- Positive contact cam-over latches
- Thick wall construction and rust-proof hinges
- Heavy-duty riveted fold-down handles
- Rugged cantilever stays

**Maximum Versatility - Built to Last!**



## Paramedic Gear Box

### Features:

- Orange with lift-out tray
- Lockable with a heavy-duty large comfort handle
- Top compartment "U" shaped 1" (2.54 cm) deep
- Positive-touch, double-latch system (top storage area)



**PM1408** 6430PM

Interior Dimensions (L x W x D):  
13.0" x 6-3/4" x 7-1/4" (33.02 x 17.15 x 18.42 cm)  
Tray Dimensions (L x W x D):  
12-3/4" x 6-1/2" x 2.0" (32.39 x 16.51 x 5.08 cm)  
Clearance under tray (L x W x D): 5-1/4" (13.33 cm)  
Packed: 4/ctn



- 360° Water Resistant: features a water-tight seal
- Lift-out tray has a center handle

## Paramedic Case

Our most complete Paramedic cases yet! These cases combine bulk storage with compartments to give you the convenience and flexibility you need.

### Features:

- Orange with black handle and latch
- Includes (4) 6004R and (2) T2003 removable Tuff Tainer® boxes\*
- Interior slotted to hold an additional (3) removable, T2003 Tuff Tainer boxes



**PM7040** 6049PM (Not Shown)

Interior Dimensions (L x W x D):  
14.0" x 8-1/2" x 3-1/4" (35.56 x 21.59 x 8.26 cm)  
Bulk Storage (L x W x D):  
14.0" x 8.0" x 4.0" (35.56 x 20.32 x 10.16 cm)  
Packed: 2/ctn



(2) T2003

(4) 6004R

\* Tuff Tainers are adjustable compartmented boxes; for dimensions of:

T2003 (pg.119), T6004 (pg. 120),

T4007E (pg. 119), T4000 (pg. 119), T1002 (pg. 119)

## Paramedic Box

The standard in emergency care cases.

### Features:

- Orange with white trays
- Heavy-duty trays - riveted cantilever rust-resistant hardware
- Lockable



**PM2072** 6774PM

Interior Dimensions (L x W x D):  
17-1/8" x 9-1/2" x 5.0" (43.50 x 24.13 x 12.70 cm)  
Tray Dimensions (L x W x D):  
14-3/8" x 6-5/8" x 2.0" (36.51 x 16.83 x 5.08 cm)  
Packed: 1/ctn

2 Tip-Proof Cantilever Trays,  
(10) Large Compartments





## First Aid Cases



- Orange, (1) compartment
- Includes white lift-out tray

Includes lift-out tray



- Orange with white trays
- (8) Compartments
- (2) Tip-proof cantilever trays



- Orange with white trays
- (8) Compartments
- (2) Tip-proof cantilever trays



### PM1702 6768PM

Interior Dimensions (L x W x D):  
15.0" x 6-3/4" x 6-1/2" (38.10 x 17.15 x 16.51 cm)  
Removable Tray Dimensions (L x W x D):  
14-3/8" x 6-5/8" x 2.0" (36.51 x 16.83 x 5.08 cm)  
Packed: 4/ctn



### PM1772 6770PM

Interior Dimensions (L x W x D):  
15.0" x 6-3/4" x 6-1/2" (38.10 x 17.15 x 16.51 cm)  
Tray Dimensions (L x W x D):  
14-1/4" x 5-3/4" x 1-3/8" (36.20 x 14.61 x 3.49 cm)  
Packed: 4/ctn



### PM1872 6772PM

Interior Dimensions (L x W x D):  
15-5/8" x 6-1/2" x 7-3/4" (39.39 x 16.51 x 19.69 cm)  
Tray Dimensions (L x W x D):  
14-3/4" x 7-1/8" x 1-3/4" (37.47 x 18.10 x 4.45 cm)  
Packed: 4/ctn

## Products you can rely on!



Our medical line is light weight, rust-proof, scratch and chemical resistant. Flambeau® medical cases, chests and instrument boxes are built to last with long-lasting durability & impact resistant. These boxes and cases are preferred by EMS, First Responders, Triage staff and other respected professionals around the globe.

## Command Center Box

Excellent for bulk storage. With integral handles on each end, this box gives you the flexibility and ease of quick transport from your vehicle to the scene. This box is durable, but light-weight and has become a favorite!

### Features:

- Orange with lift-out tray
- Lockable with 2 power latches

### PM27800 6754PM

Interior Dimensions (L x W x D):  
23.0" x 12-1/2" x 12.0" (58.42 x 31.75 x 30.40 cm)  
Removable Tray Dimensions (L x W x D):  
12.0" x 11-3/4" x 2.0" (30.48 x 29.85 x 5.08 cm)  
Packed: 2/ctn





# Trauma Drug Kits

Our trauma drug kits have a drop-front panel for easy access to the storage bin below, a positive cam-over latch, and are lockable for protection of contents. The ABS drawers can be sterilized. All drawers are removable and interchangeable.

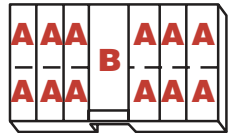

**Drawer B (#AR841-10):** **Drawer B Compartments**  
 L = 15-9/16" (39.53 cm),  
 W = 8-13/16" (22.84 cm),  
 D = 1-3/8" (3.49 cm)  
**Dimensions (L x W x D):**  
**A** = 1-15/16" x 4-1/2" x 1-1/4"  
 (4.92 x 11.43 x 3.18 cm),  
**B** = 3-3/16" x 8-7/8" x 1-1/4"  
 (8.10 x 22.54 x 3.18 cm)

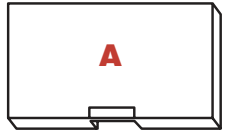

**Drawer C (#AR869-10):** **Drawer C Compartments**  
 L = 15-9/16" (39.53 cm),  
 W = 8-13/16" (22.84 cm),  
 D = 2-7/8" (7.30 cm)  
**Dimensions (L x W x D):**  
**A** = 15-1/8" x 8-5/8" x 2-5/8"  
 (38.42 x 21.91 x 6.67 cm)

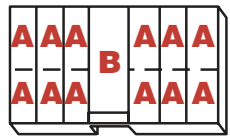

**Drawer B (#AR841-10):** **Drawer B Compartments**  
 L = 15-9/16" (39.53 cm),  
 W = 8-13/16" (22.84 cm),  
 D = 1-3/8" (3.49 cm)  
**Dimensions (L x W x D):**  
**A** = 1-15/16" x 4-1/2" x 1-1/4"  
 (4.92 x 11.43 x 3.18 cm),  
**B** = 3-3/16" x 8-7/8" x 1-1/4"  
 (8.10 x 22.54 x 3.18 cm)

To order replacement drawers, please call Customer Service: 1-800-344-5716. Be sure to give them the Drawer letter (A, B, etc.) and number listed after "#" in this section for easier ordering.



**PM2272 6776PM**

Description: Orange with White Drawers and (27) Compartments  
 Outside Dimensions (L x W x D):  
 19-1/2" x 11-1/2" x 11-3/4" (49.53 x 29.21 x 29.85 cm)  
 Drawer Configuration: (1) B and (1) C  
 Packed: 1/ctn



**PM2273 6777PM**

Description: Orange with White Drawers and (53 - 65) Compartments  
 Outside Dimensions (L x W x D):  
 19-1/2" x 11-1/2" x 11-3/4" (49.53 x 29.21 x 29.85 cm)  
 Drawer Configuration: (3) B  
 Packed: 1/ctn





# Drawer Cabinets

Our drawer cabinets feature a front panel that easily drops down and provides access to the drawers inside. The front panel also features a lockable latch for extra security. ABS drawers can be sterilized and are removable and interchangeable.



**PM2274** 6762PM

Description: Orange with White Drawers and (27) Compartments

Outside Dimensions (L x W x D):

19-1/2" x 10-3/8" x 15.0" (49.53 x 26.35 x 38.10 cm)

Drawer Configuration: (1) A, (1) C, (1) D and (1) E

Packed: 1/ctn



**PM2275** 6763PM

Description: Orange with White Drawers and (53 - 65) Compartments

Outside Dimensions (L x W x D):

19-1/2" x 10-3/8" x 15.0" (49.53 x 26.35 x 38.10 cm)

Drawer Configuration: (2) B, (2) D and (1) E

Packed: 1/ctn

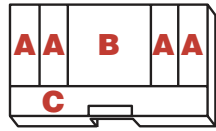

**Drawer A (#AR839-10):**

L = 15-9/16" (39.53 cm),  
W = 8-13/16" (22.84 cm),  
D = 1-3/8" (3.49 cm)

**Drawer A Compartments**

Dimensions (L x W x D):  
**A** = 1-15/16" x 6-3/16" x 1-1/4"  
(4.92 x 15.72 x 3.18 cm),  
**B** = 7-5/16" x 6-3/16" x 1-1/4"  
(18.57 x 15.72 x 3.18 cm),  
**C** = 15-1/8" x 2-7/16" x 1-1/4"  
(5.08 x 7.94 x 3.18 cm)



**Drawer C (#AR869-10):**

L = 15-9/16" (39.53 cm),  
W = 8-13/16" (22.84 cm),  
D = 2-7/8" (7.30 cm)

**Drawer C Compartments**

Dimensions (L x W x D):  
**A** = 15-1/8" x 8-5/8" x 2-5/8"  
(38.42 x 21.91 x 6.67 cm)

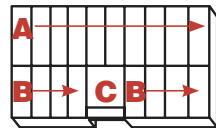

**Drawer D (#AR840-10):**

L = 15-9/16" (39.53 cm),  
W = 8-13/16" (22.84 cm),  
D = 1-3/8" (3.49 cm)

**Drawer D Compartments**

Dimensions (L x W x D):  
**A** = 1-3/8" x 5-1/16" x 1-1/4"  
(3.49 x 12.86 x 3.18 cm),  
**B** = 1-3/8" x 3-9/16" x 1-1/4"  
(3.49 x 9.05 x 3.18 cm),  
**C** = 3-3/16" x 3-9/16" x 1-1/4"  
(8.10 x 9.05 x 3.18 cm)



**Drawer E (#AR928-10):**

L = 15-9/16" (39.53 cm),  
W = 8-13/16" (22.84 cm),  
D = 2-7/8" (7.30 cm)

**Drawer E Compartments**

Dimensions (L x W x D):  
**A** = 15-1/8" x 8-5/8" x 4-5/16"  
(38.42 x 21.91 x 10.95 cm)

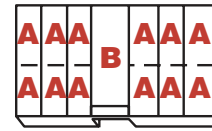

**Drawer B (#AR841-10):**

L = 15-9/16" (39.53 cm),  
W = 8-13/16" (22.84 cm),  
D = 1-3/8" (3.49 cm)

**Drawer B Compartments**

Dimensions (L x W x D):  
**A** = 1-15/16" x 4-1/2" x 1-1/4"  
(4.92 x 11.43 x 3.18 cm),  
**B** = 3-3/16" x 8-7/8" x 1-1/4"  
(8.10 x 22.54 x 3.18 cm)

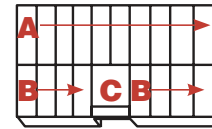

**Drawer D (#AR840-10):**

L = 15-9/16" (39.53 cm),  
W = 8-13/16" (22.84 cm),  
D = 1-3/8" (3.49 cm)

**Drawer D Compartments**

Dimensions (L x W x D):  
**A** = 1-3/8" x 5-1/16" x 1-1/4"  
(3.49 x 12.86 x 3.18 cm),  
**B** = 1-3/8" x 3-9/16" x 1-1/4"  
(3.49 x 9.05 x 3.18 cm),  
**C** = 3-3/16" x 3-9/16" x 1-1/4"  
(8.10 x 9.05 x 3.18 cm)



**Drawer E (#AR928-10):**

L = 15-9/16" (39.53 cm),  
W = 8-13/16" (22.84 cm),  
D = 2-7/8" (7.30 cm)

**Drawer E Compartments**

Dimensions (L x W x D):  
**A** = 15-1/8" x 8-5/8" x 4-5/16"  
(38.42 x 21.91 x 10.95 cm)

To order replacement drawers, please call Customer Service: 1-800-344-5716. Be sure to give them the Drawer letter (A, B, etc.) and number listed after "#" in this section for easier ordering.





**Withstands Autoclaving and Sterilization!**

### Medical Device Box

Store, transport, and protect cardiac implant devices and most other small wafer type implantable devices. Sterilize with ETO; Gamma; or E-Beam process. Made of tough Polypropylene material. This box can easily be customized with logo or name plate.



**6528MD 6528MD**

Description: Natural  
 Inside Dimensions (L x W x D):  
 5-3/10" x 5-3/10" x 1-1/2" (13.46 x 13.46 x 3.81 cm)  
 Tray Dimensions (L x W x D):  
 5-3/10" x 5-3/10" x 1-1/2" (13.46 x 13.46 x 3.81 cm)  
 Packed: 24/ctn

### Instrument Boxes

Ideal for your small or delicate equipment.

Features:

- Integral hinge and positive latch
- Durable polypropylene construction



MODEL #	STOCK #	DESCRIPTION	DIMENS. (INSIDE: L x W x D)	PACKED
<b>V301</b>	6142VB	Orange, 1 Compartment with Hanging Tag	7.0" x 3-1/4" x 1.0" (17.78 x 8.26 x 2.54 cm)	36/ctn
<b>V301PT</b>	6650VC	Taupe, 1 Compartment	7.0" x 3-1/4" x 1.0" (17.78 x 8.26 x 2.54 cm)	36/ctn
<b>V401</b>	6152VB	Taupe, 1 Compartment	8-1/8" x 4-1/8" x 1-3/16" (20.64 x 10.48 x 3.02 cm)	24/ctn
<b>V401D-2</b>	6654DV	Taupe, 1 Deep Compartment	8-1/8" x 4-1/8" x 2-5/8" (20.64 x 10.48 x 6.03 cm)	24/ctn
<b>V501</b>	6160VB	Taupe, 1 Compartment	10.0" x 4-1/4" x 1-1/2" (25.40 x 10.80 x 3.81 cm)	24/ctn
<b>V601</b>	6667VB	Taupe, 1 Compartment	13-1/2" x 5-3/4" x 2.0" (34.29 x 14.61 x 5.08 cm)	12/ctn
<b>V701</b>	6172VB	Taupe, 1 Compartment	17.0" x 7-1/8" x 2.0" (43.18 x 18.10 x 5.08 cm)	6/ctn

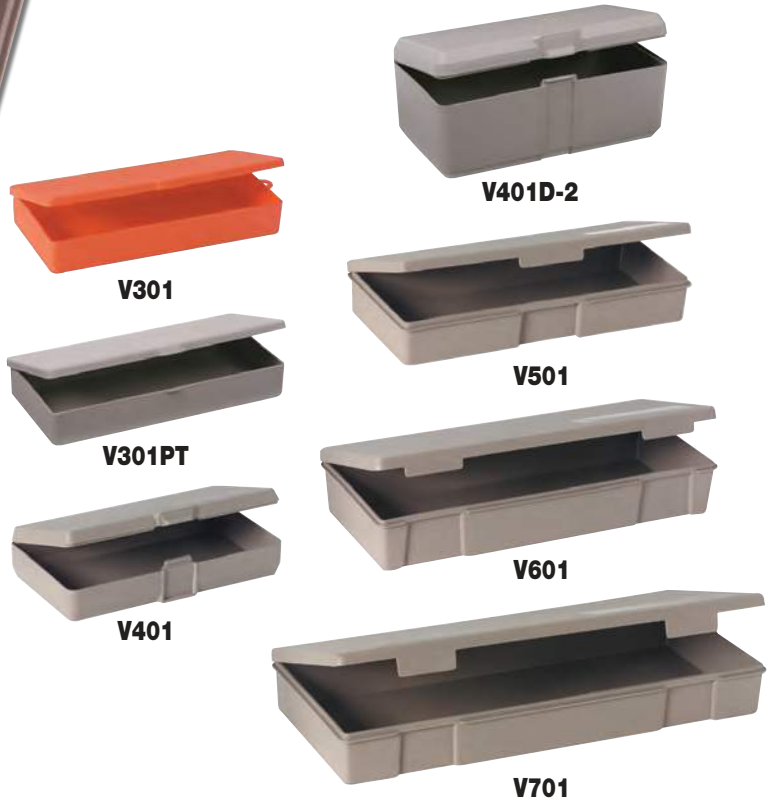



Designed to safely store prescription medications from inquisitive eyes.

## ScriptSafe® Case

ScriptSafe® is a heavy-duty plastic carrying case with patented locking features designed to safely store and help secure prescription medications. Two of the three configurations feature a “cam-actuated” locking mechanism which locks the case down—while the contents inside remain locked.

**Features:**

- Steel hinge pin construction
- Tamper resistant hinge segments
- Patented “Lockdown” features (models 6526MD and 6527MD)
- Includes 2 keys

Patent # 8,695,386



**6525MD 6525MD**  
Open Core Design



**6526MD 6526MD**  
Short Axle Lockdown Feature



**6527MD 6527MD**  
Divided Core Design

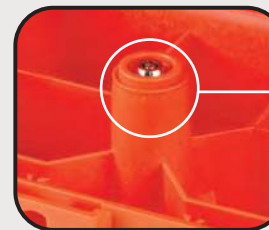

Tall Axle Lockdown Feature

MODEL #	STOCK #	DESCRIPTION	DIMENS. (INSIDE: L x W x D)	PACKED
<b>6525MD</b>	6525MD	Orange, Open Core w/Out Lockdown Feature	8-1/2" x 7-1/8" x 2-3/4" (21.59 x 18.10 x 6.99 cm)	12/ctn
<b>6526MD</b>	6526MD	Orange, Open Core w/Lockdown Feature	8-1/2" x 7-1/8" x 2-3/4" (21.59 x 18.10 x 6.99 cm)	12/ctn
<b>6527MD®</b>	6527MD	Orange, Divided Core w/Lockdown Feature	8-1/2" x 7-1/8" x 2-3/4" (21.59 x 18.10 x 6.99 cm)	12/ctn



Guard Against Expensive Damage



Static Dissipative Slim Line™ Box

The Static Dissipative Slim Line™ Box has been engineered to protect ESDs (electrostatic-sensitive devices). This box is manufactured with static

dissipative material that protects computer cards, chips and circuits from harmful static electricity. This product has an ESD protection range of  $1 \times 10^6$  -  $1 \times 10^{10}$ .

EDS401F

**NEW**

Optional foam available upon request



**NEW**

ESD401 6600ES

Description: Black  
 Inside Dimensions (L x W x D):  
 4-1/2" x 3-1/2" x 1/2" (11.43 x 83.89 x 1.27 cm)  
 Packed: 48/ctn



**3 New Sizes Coming Soon!**

3.6" x 2.6" x 1.0"



3.6" x 2.6" x .75"



2.6" x 2.6" x .50"





# Conductive Cases

## Options:

- Clear conductive window (Special order styles only)
  - Easy part identification without compromise of Faraday Cage protection
- Grounding Snap
  - Reduces surface charges so the case can be safely opened without damaging contents
- Antistatic or conductive foam
  - (Conductive quoted separately)
  - (Antistatic included upon request, foam is glued into the case)
  - Provides physical shock resistance, reduces the potential for static build-up and arc due to the low friction coefficient of the foam

## Technical Data:

- Surface resistivity  $10^{10}$ - $10^{11}$  (ASTM D 257 / ESD S11.11)
- Static decay <2.0 seconds (MIL-PRF-81705D)

## Features:

- Double wall construction - maximum physical protection
- Locking tabs (select items)
- Secure positive, integral double latches
- ESD protection
- Reusable and stackable



MODEL #	STOCK #	DESCRIPTION	DIMENSIONS (INSIDE: L x W x D* *) *B = Base; L = Lid; * *Depth = Base + Lid	PACKED
<b>50019</b>	50019 / 21460	5 x 3 Conductive Case	5-1/16" x 2-3/4" B*, 2-5/8" L* x 1" (13.49 x 6.99 B*, 6.67 L* x 2.54 cm)	341/ctn
<b>21463</b>	21463	6 x 5 Conductive Case	6-3/4" B*, 6-1/2" L* x 5.0" B*, 4-3/4" L* x 1-1/16" (17.15 B*, 16.51 L* x 12.70 B*, 12.07 L* x 3.02 cm)	135/ctn
<b>50014</b>	50014	9 x 7 Conductive Case w/Wire Tie Feature	8-15/16" B*, 9-1/16" L* x 6-5/8" B*, 6-1/2" L* x 1-1/4" (22.70 B*, 23.02 L* x 16.83 B*, 16.51 L* x 3.18 cm)	96/ctn
<b>50015</b>	50015	12 x 8 Conductive Case w/Wire Tie Feature	11-7/8" B*, 11-15/16" L* x 8-3/16" B*, 8-7/16" L* x 1-1/4" (30.16 B*, 30.32 L* x 20.80 B*, 21.43 L* x 3.18 cm)	54/ctn
<b>21458</b>	21458	13 x 11 Conductive Case w/Wire Tie Feature	12-3/4" x 10-1/2" x 1-3/4" (32.39 x 26.67 x 4.45 cm)	30/ctn
<b>21459</b>	21459	15 x 6 Conductive Case	15.0" x 6-1/2" x 2.0" (38.10 x 16.51 x 5.08 cm) 24/ctn	
<b>21462</b>	21462	18 x 14 Conductive Case w/Wire Tie Feature	17-1/2" x 13-1/2" x 1-5/16" (44.45 x 34.29 x 3.33 cm)	7/ctn
<b>21461</b>	21461	18 x 18 Conductive Case w/Wire Tie Feature	18-7/16" x 17-11/16" x 1-15/16" (46.83 x 44.93 x 4.92 cm)	10/ctn

# Conductive Storage Cabinets

High-density storage, maximum organization and cost savings efficiency can be achieved with our generous selection of conductive storage cabinets. Each drawer cabinet features conductive drawers and drawer stops to prevent accidental spills.



Conductive Dividers

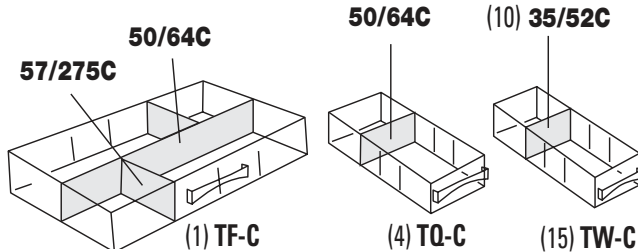
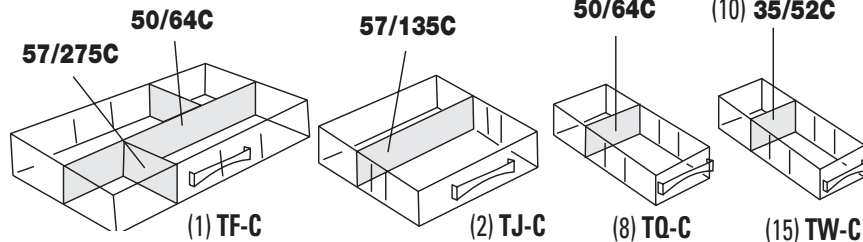

C20P



C26P



U30P



U45P

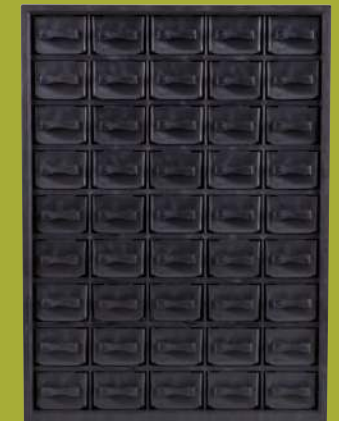

MODEL #	STOCK #	DESCRIPTION	USES DIVIDER #	DIMENS. (OUT: L x W x H)	PACKED
<b>C20P-C</b>	6575CD	Black Black Drawers Black Dividers	* (10) <b>35/52C</b> <b>50/64C</b> <b>57/275C</b>	12.0" x 6-1/4" x 11-1/4" (30.48 x 15.88 x 28.58 cm)	4/ctn
<b>C26P-C</b>	6576CD	Black Black Drawers Black Dividers	* (10) <b>35/52C</b> <b>50/64C</b> <b>57/135C</b> <b>57/275C</b>	12.0" x 6-1/4" x 16-1/2" (30.48 x 15.88 x 41.91 cm)	4/ctn
<b>U30P-C</b>	6573CD	Black Black Drawer Black Dividers	* (10) <b>35/52C</b>	12.0" x 6-1/4" x 11-1/4" (30.48 x 15.88 x 28.58 cm)	4/ctn
<b>U45P-C</b>	6574CD	Black Black Drawers Black Dividers	* (10) <b>35/52C</b>	12.0" x 6-1/4" x 16-1/2" (30.48 x 15.88 x 41.91 cm)	4/ctn

\* All cabinets include (10) 35/52 dividers, all other dividers are optional

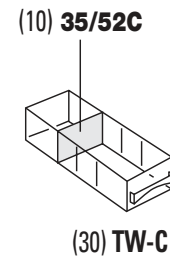

(30) TW-C

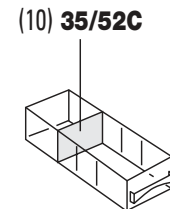

(45) TW-C



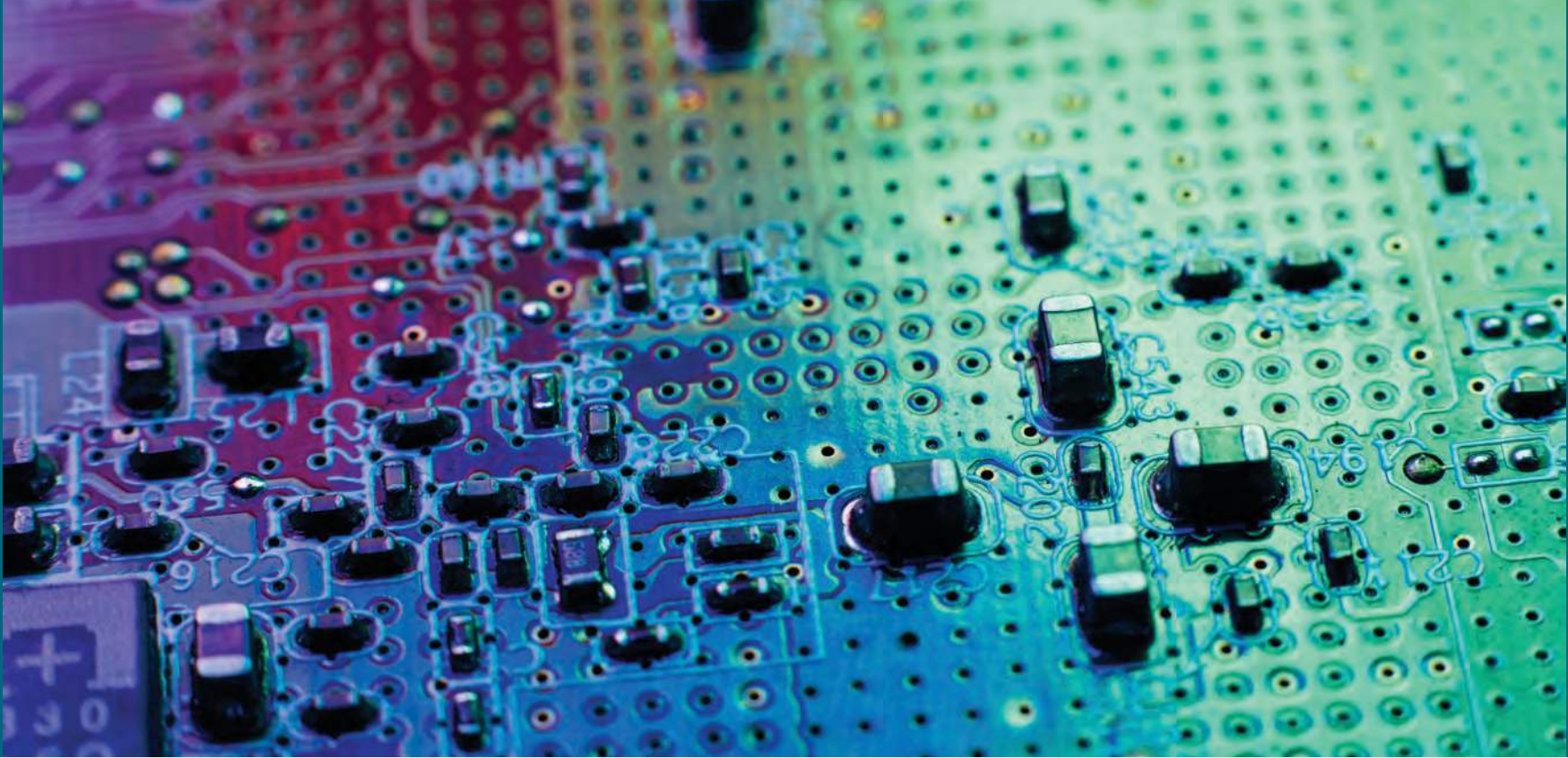

## Drawer Descriptions

MODEL #	STOCK #	PRODUCT DESCRIPTION	DIMENSIONS (OUTSIDE: L x W x H)	PACKED
<b>TW-C</b>	6061DP	Uses (3) 35/52C Dividers, (dividers sold separately)	2.0" x 5-3/8" x 1-3/8" (5.08 x 13.65 x 3.49 cm)	6/pk
<b>TQ-C</b>	6064DP	Uses (3) 50/64C Dividers, (dividers sold separately)	2-1/2" x 5-3/8" x 2-1/4" (6.35 x 13.65 x 5.72 cm)	6/pk
<b>TJ-C</b>	6065DP	Uses (3) 57/135C Dividers, (dividers sold separately)	5-3/8" x 5-3/8" x 2-1/4" (13.65 x 13.65 x 5.72 cm)	6/pk
<b>TF-C</b>	6067DP	Uses (3) 57/135C or (1) 57/275C or (1) 57/275C & (6) 50/64C Dividers, (dividers sold separately)	10-7/8" x 5-3/8" x 2-1/4" (27.62 x 13.65 x 5.72 cm)	6/pk

## Divider Descriptions

MODEL #	STOCK #	PRODUCT DESCRIPTION	DIMENSIONS (OUTSIDE: L x W x H)	PACKED
<b>35/52C</b>	6780CD	Divider Fits Drawer TW-C, Divider Wall Thickness 1/16" (1.59 cm)	2.0" x 1-1/4" x 1/8" (5.08 x 3.18 x 0.32 cm)	25/pk
<b>50/64C</b>	6785CD	Divider Fits Drawer TQ-C & TF-C, Divider Wall Thickness 1/16" (1.59 cm)	2-1/2" x 5-3/8" x 2-1/4" (6.35 x 13.65 x 5.72 cm)	24/pk
<b>57/135C</b>	6782CD	Divider Fits Drawer TF-C & TJ-C, Divider Wall Thickness 1/16" (1.59 cm)	5-3/8" x 5-3/8" x 2-1/4" (13.65 x 13.65 x 5.72 cm)	12/pk
<b>57/275C</b>	6784CD	Divider Fits Drawer TF-C, Divider Wall Thickness 1/16" (1.59 cm)	10-7/8" x 5-3/8" x 2-1/4" (27.62 x 13.65 x 5.72 cm)	6/pk



# 600/800 Box Series



**C601 6707TC**  
**600 Box, Open Core**

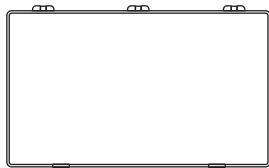

1 Compartment



**C618 6714TC**  
**600 Box, Divided**

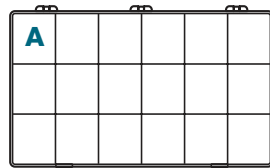

18 Compartments (L x W):  
**A=** 2-1/16" x 1-3/4"  
 (5.24 x 4.45 cm)



**C801 6734TC**  
**800 Box, Open Core**



1 Compartment



**C824 6726TC**  
**800 Box, Divided**

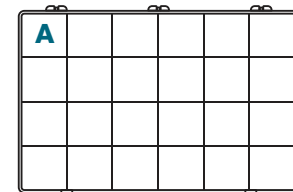

24 Compartments (L x W):  
**A=** 2-1/16" x 2-1/16"  
 (5.24 x 5.24 cm)

MODEL #	STOCK #	DESCRIPTION	DIMENSIONS (INSIDE: L x W x D)	PACKED
<b>C601</b>	6707TC	Black, 1 Compartment	10-1/2" x 6-3/16" x 1-9/16" (26.67 x 15.72 x 3.97 cm)	24/ctn
<b>C618</b>	6714TC	Black, 18 Compartment	10-1/2" x 6-3/16" x 1-9/16" (26.67 x 15.72 x 3.97 cm)	24/ctn
<b>C801</b>	6734TC	Black, 1 Compartment	12-3/4" x 8-1/2" x 2-1/8" (32.39 x 21.59 x 5.40 cm)	12/ctn
<b>C824</b>	6726TC	Black, 24 Compartment	12-3/4" x 8-1/2" x 2-1/8" (32.39 x 21.59 x 5.40 cm)	12/ctn

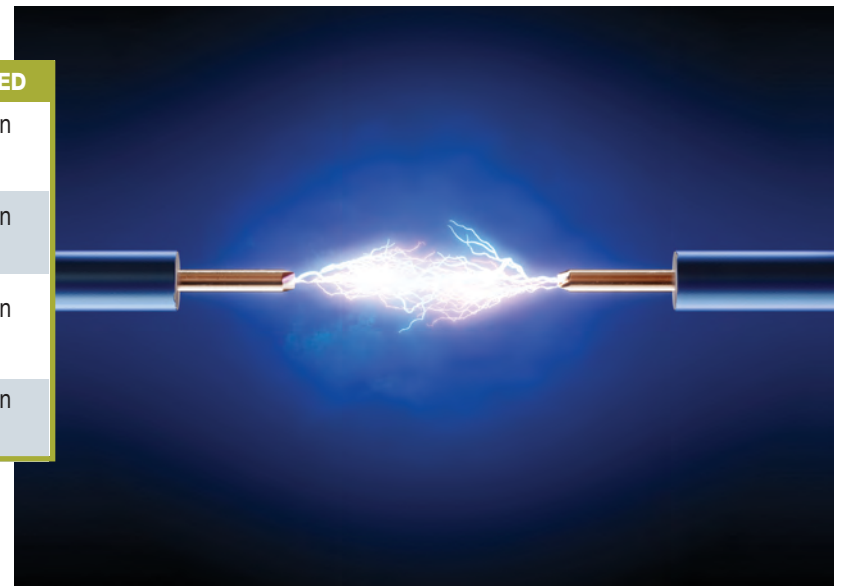

## Boxes: 4" x 6", 6" x 6" and 12" x 12"

Made out of translucent clear, acid-free polypropylene, these boxes, are ideal for displaying products. These boxes feature durable back hinges and an integrated, positive locking latch to help secure contents. With a wide-open concept, these boxes are suitable for various applications. Easily customize with your company's logo for that finished look!

**6764TE** 6764TE  
**4" x 6" Box**



**6766TE** 6766TE  
**6" x 6" Box**

Great for first-aid supplies



**6762TE** 6762TE  
**12" x 12" Box Without Handle**



**6763TE** 6763TE  
**12" x 12" Box With Handle**



With handle

MODEL #	STOCK #	DESCRIPTION	DIMENS. (INSIDE: L x W x D)	PACKED
<b>6764TE</b>	6764TE	4 x 6, Clear	6-5/8" x 4-3/4" x 1-1/8" (16.82 x 12.06 x 2.85 cm)	12/ctn
<b>6766TE</b>	6766TE	6 x 6, Clear	6-1/4" x 6-1/4" x 2-1/8" (15.88 x 15.88 x 5.40 cm)	6/ctn
<b>6762TE</b>	6762TE	12 x 12, Clear W/Out Handle	14-1/8" x 13-5/8" x 3.0" (35.87 x 34.60 x 7.62 cm)	3/ctn
<b>6763TE</b>	6763TE	12 x 12, Clear With Handle	14-1/8" x 13-5/8" x 3.0" (35.87 x 34.60 x 7.62 cm)	3/ctn

## Medical Device Box

Store, transport, and protect cardiac implant devices and most other small wafer type implantable devices. Sterilize with ETO; Gamma; or E-Beam process. Made of tough Polypropylene material. This box can easily be customized with logo or name plate.

**6528MD** 6528MD

Description: Natural  
 Inside Dimensions (L x W x D):  
 5-3/10" x 5-3/10" x 1-1/2" (13.46 x 13.46 x 3.81 cm)  
 Tray Dimensions (L x W x D):  
 5-3/10" x 5-3/10" x 1-1/2" (13.46 x 13.46 x 3.81 cm)  
 Packed: 24/ctn



## A - Series



## Styrene

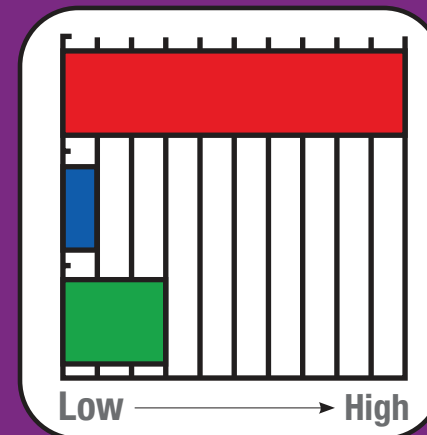

- Clarity\*
- Impact Resistance
- Chemical Resistance

The original Flambeau styrene box. The A-Series has a distinct stout look with square corners and true 90° walls. Still a popular pick with customers from many industries. From crafts to electronics and more, these crystal clear containers offer easy access and are great for organized storage.



**SIZE RANGE** 4-1/4 dia. x 3/4" (10.80 dia. x 1.91 cm) — 5-5/8" x 2-15/16" x 1-1/8" (14.29 x 7.46 x 2.86 cm)

**BOX MATERIAL KEY**

**SYMBOL KEY**

**TP** = Translucent Polypropylene    **TCP** = Transparent Cellulose Propionate    **SP** = Taupe Polypropylene  
**YP** = Yellow Polypropylene    **SBMM** = Styrene-Butadiene Methyl Methacrylate    **OP** = Orange Polypropylene  
**WP** = White Polypropylene    **SBC** = Styrene-Butadiene Copolymer

Special Order 

BOX DIAGRAM	MODEL #	STOCK #	SERIES FAMILY	BOX MATERIAL	DIMENSIONS (INSIDE: L x W x D)	PACKED
 1 Compartment	<b>A01</b> 	6685CC	<b>A-Series</b>	Styrene	4-1/4" dia. x 3/4" (10.80 dia. x 1.91 cm)	80/ctn
 1 Compartment	<b>A226</b>	6644CB	<b>A-Series</b>	Styrene	4-3/8" x 2-5/8" x 1.0" (11.11 x 6.67 x 2.54 cm)	36/ctn
 8 Compartments (L x W): <b>A</b> = 1.0" x 1-1/4" (2.54 x 3.18 cm)	<b>A228</b>	6646CB	<b>A-Series</b>	Styrene	4-3/8" x 2-5/8" x 1.0" (11.11 x 6.67 x 2.54 cm)	36/ctn
 4 Compartments (L x W): <b>A</b> = 2-3/16" x 1-5/16" (5.56 x 3.33 cm)	<b>A221</b>	6642CB	<b>A-Series</b>	Styrene	4-3/8" x 2-5/8" x 1.0" (11.11 x 6.67 x 2.54 cm)	36/ctn
 6 Compartments (L x W): <b>A</b> = 1-3/8" x 1-1/4" (3.49 x 3.18 cm)	<b>A220</b>	6640CB	<b>A-Series</b>	Styrene	4-3/8" x 2-5/8" x 1.0" (11.11 x 6.67 x 2.54 cm)	36/ctn
 1 Compartment	<b>A101</b>	6600CB	<b>A-Series</b>	Styrene	5-1/8" x 3-9/16" x 1-1/2" (13.02 x 9.05 x 3.81 cm)	36/ctn
 4 Compartments (L x W): <b>A</b> = 2-3/4" x 1-7/16" (6.99 x 3.65 cm)	<b>A154</b>	6602CB	<b>A-Series</b>	Styrene	5-5/8" x 2-15/16" x 1-1/8" (14.29 x 7.46 x 2.86 cm)	36/ctn
 5 Compartments (L x W): <b>A</b> = 1.0" x 2-7/8" (2.54 x 7.30 cm)	<b>A155</b>	6604CB	<b>A-Series</b>	Styrene	5-5/8" x 2-15/16" x 1-1/8" (14.29 x 7.46 x 2.86 cm)	36/ctn

A-SERIES

**SIZE RANGE**

**5-7/8" x 3-3/4" x 1-5/8"** (14.92 x 9.53 x 4.13 cm) — **8.0" x 4.0" x 1-3/16"** (20.32 x 10.16 x 3.02 cm)

**BOX MATERIAL KEY**

**SYMBOL KEY**

**TP** = Translucent Polypropylene  
**YP** = Yellow Polypropylene  
**WP** = White Polypropylene

**TCP** = Transparent Cellulose Propionate  
**SBMM** = Styrene-Butadiene Methyl Methacrylate  
**SBC** = Styrene-Butadiene Copolymer

**SP** = Taupe Polypropylene  
**OP** = Orange Polypropylene

Special Order 

BOX DIAGRAM	MODEL #	STOCK #	SERIES FAMILY	BOX MATERIAL	DIMENSIONS (INSIDE: L x W x D)	PACKED
	<b>A250</b>	6648CB	<b>A-Series</b>	Styrene	5-7/8" x 3-3/4" x 1-5/8" (14.92 x 9.53 x 4.13 cm)	36/ctn
<b>1 Compartment, Box Has Lift-Off Lid (Non-Hinged)</b>						
	<b>A213</b>	6621CM	<b>A-Series</b>	Styrene	6-3/4" x 3-3/16" x 1-3/16" (17.15 x 8.10 x 3.02 cm)	36/ctn
<b>10 Compartments (L x W): A= 1-1/2" x 1-5/8" (3.81 x 4.13 cm), B= 1-7/16" x 1-5/8" (3.65 x 4.13 cm), C= 1-5/16" x 1-5/8" (3.33 x 4.13 cm), D= 1-1/4" x 1-5/8" (3.18 x 4.13 cm), E= 1-1/8" x 1-5/8" (2.86 x 4.13 cm)</b>						
	<b>A214</b>	6628CB	<b>A-Series</b>	Styrene	6-3/4" x 3-3/16" x 1-3/16" (17.15 x 8.10 x 3.02 cm)	36/ctn
<b>2 Compartments (L x W): A= 3-5/16" x 3-1/4" (8.41 x 8.26 cm)</b>						
	<b>A215</b>	6630CB	<b>A-Series</b>	Styrene	6-3/4" x 3-3/16" x 1-3/16" (17.15 x 8.10 x 3.02 cm)	36/ctn
<b>5 Compartments (L x W): A= 1-5/16" x 3-3/16" (3.33 x 8.10 cm)</b>						
	<b>A210</b>	6622CB	<b>A-Series</b>	Styrene	6-3/4" x 3-3/16" x 1-3/16" (17.15 x 8.10 x 3.02 cm)	36/ctn
<b>9 Compartments (L x W): A= 1-5/16" x 1-9/16" (3.33 x 3.97 cm), B= 1-1/8" x 3-3/16" (2.86 x 8.10 cm)</b>						
	<b>A219</b>	6636CB	<b>A-Series</b>	Styrene	6-3/4" x 3-3/16" x 1-3/16" (17.15 x 8.10 x 3.02 cm)	36/ctn
<b>12 Compartments (L x W): A= 1-7/16" x 1-1/16" (3.65 x 2.70 cm)</b>						
	<b>A217</b>	6634CB	<b>A-Series</b>	Styrene	6-3/4" x 3-3/16" x 1-3/16" (17.15 x 8.10 x 3.02 cm)	36/ctn
<b>7 Compartments (L x W): A= 1-5/16" x 1-5/8" (3.33 x 4.13 cm), B= 4.0" x 1-1/16" (10.16 x 2.70 cm)</b>						
	<b>A211</b>	6624CB	<b>A-Series</b>	Styrene	6-3/4" x 3-3/16" x 1-3/16" (17.15 x 8.10 x 3.02 cm)	36/ctn
<b>6 Compartments (L x W): A= 1-1/16" x 3-3/16" (2.70 x 8.10 cm)</b>						

**A-SERIES**

\* Adding color to the resins effects the clarity of the finished product

A-SERIES

BOX DIAGRAM	MODEL #	STOCK #	SERIES FAMILY	BOX MATERIAL	DIMENSIONS (INSIDE: L x W x D)	PACKED
 1 Compartment	<b>A216</b>	6632CB	<b>A-Series</b>	Styrene	6-3/4" x 3-3/16" x 1-3/16" (17.15 x 8.10 x 3.02 cm)	36/ctn
 5 Compartments (L x W): <b>A=</b> 2-1/2" x 1-5/8" (6.35 x 4.13 cm), <b>B=</b> 1-5/8" x 3-1/4" (4.13 x 8.26 cm)	<b>A212</b>	6626CB	<b>A-Series</b>	Styrene	6-3/4" x 3-3/16" x 1-3/16" (17.15 x 8.10 x 3.02 cm)	36/ctn
 1 Compartment	<b>A701</b>	6670CB	<b>A-Series</b>	Styrene	6-7/8" x 2-1/16" x 1.0" (17.46 x 5.24 x 2.54 cm)	36/ctn
 1 Compartment	<b>A401</b>	6650CB	<b>A-Series</b>	Styrene	7-1/8" x 5-1/8" x 1-9/16" (18.10 x 13.02 x 3.97 cm)	36/ctn
 12 Compartments (L x W): <b>A=</b> 2-5/8" x 1-5/16" (6.67 x 3.33 cm), <b>B=</b> 1-5/16" x 1-1/4" (3.33 x 3.18 cm), <b>C=</b> 2-5/8" x 2-11/16" (6.67 x 6.83 cm)	<b>A204</b>	6614CB	<b>A-Series</b>	Styrene	8.0" x 4.0" x 1-3/16" (20.32 x 10.16 x 3.02 cm)	24/ctn
 1 Compartment	<b>A206</b>	6616CB	<b>A-Series</b>	Styrene	8.0" x 4.0" x 1-3/16" (20.32 x 10.16 x 3.02 cm)	24/ctn
 9 Compartments (L x W): <b>A=</b> 2-5/8" x 1-5/16" (6.67 x 3.33 cm), <b>B=</b> 1-1/4" x 1-5/16" (3.18 x 3.33 cm), <b>C=</b> 4.0" x 4.0" (10.16 x 10.16 cm)	<b>A209</b>	6620CB	<b>A-Series</b>	Styrene	8.0" x 4.0" x 1-3/16" (20.32 x 10.16 x 3.02 cm)	24/ctn
 18 Compartments (L x W): <b>A=</b> 1-1/4" x 1-1/4" (3.18 x 3.18 cm)	<b>A200</b>	6608CB	<b>A-Series</b>	Styrene	8.0" x 4.0" x 1-3/16" (20.32 x 10.16 x 3.02 cm)	24/ctn
 12 Compartments (L x W): <b>A=</b> 1-1/4" x 1-15/16" (3.18 x 4.92 cm)	<b>A208</b>	6618CB	<b>A-Series</b>	Styrene	8.0" x 4.0" x 1-3/16" (20.32 x 10.16 x 3.02 cm)	24/ctn



**SIZE RANGE**

**8.0" x 4.0" x 1-3/16"** (20.32 x 10.16 x 3.02 cm) — **10-9/16" x 8-1/4" x 1-9/16"** (26.83 x 20.96 x 3.97 cm)

**BOX MATERIAL KEY**

**SYMBOL KEY**

**TP** = Translucent Polypropylene  
**YP** = Yellow Polypropylene  
**WP** = White Polypropylene

**TCP** = Transparent Cellulose Propionate  
**SBMM** = Styrene-Butadiene Methyl Methacrylate  
**SBC** = Styrene-Butadiene Copolymer

**SP** = Taupe Polypropylene  
**OP** = Orange Polypropylene

Special Order 

BOX DIAGRAM	MODEL #	STOCK #	SERIES FAMILY	BOX MATERIAL	DIMENSIONS (INSIDE: L x W x D)	PACKED
	<b>A201</b>	6610CB	<b>A-Series</b>	Styrene	8.0" x 4.0" x 1-3/16" (20.32 x 10.16 x 3.02 cm)	24/ctn
<b>12 Compartments (L x W):</b> <b>A</b> = 1-5/16" x 1-5/16" (3.33 x 3.33 cm), <b>B</b> = 1-5/16" x 4.0" (3.33 x 10.16 cm), <b>C</b> = 1-5/16" x 2.0" (3.33 x 5.08 cm)						
	<b>A203</b>	6612CB	<b>A-Series</b>	Styrene	8.0" x 4.0" x 1-3/16" (20.32 x 10.16 x 3.02 cm)	24/ctn
<b>6 Compartments (L x W):</b> <b>A</b> = 1-1/4" x 4.0" (3.18 x 10.16 cm)						
	<b>A166-36</b>	6606CB	<b>A-Series</b>	Styrene	9-5/8" x 6-9/16" x 1-1/2" (24.45 x 16.69 x 3.81 cm)	12/ctn
<b>36 Compartments (L x W):</b> <b>A</b> = 1-9/16" x 1-1/16" (3.97 x 2.70 cm)						
	<b>A623</b> 	6668CB	<b>A-Series</b>	Styrene	10-1/2" x 6-3/16" x 1-9/16" (26.67 x 15.72 x 3.97 cm)	24/ctn
<b>13 Compartments (L x W):</b> <b>A</b> = 10-3/8" x 2-5/8" (26.35 x 6.67 cm), <b>B</b> = 1-11/16" x 1-5/16" (4.29 x 3.33 cm), <b>C</b> = 1-11/16" x 2.0" (4.29 x 5.08 cm)						
	<b>A612</b> 	6662CB	<b>A-Series</b>	Styrene	10-1/2" x 6-3/16" x 1-9/16" (26.67 x 15.72 x 3.97 cm)	24/ctn
<b>12 Compartments (L x W):</b> <b>A</b> = 1-11/16" x 2.0" (4.29 x 5.08 cm), <b>B</b> = 1-11/16" x 4-1/8" (4.29 x 10.48 cm)						
	<b>A602</b>	6654CB	<b>A-Series</b>	Styrene	10-1/2" x 6-3/16" x 1-9/16" (26.67 x 15.72 x 3.97 cm)	24/ctn
<b>12 Compartments (L x W):</b> <b>A</b> = 1-11/16" x 3-1/16" (4.29 x 7.78 cm)						
	<b>A606</b>	6658CB	<b>A-Series</b>	Styrene	10-1/2" x 6-3/16" x 1-9/16" (26.67 x 15.72 x 3.97 cm)	24/ctn
<b>6 Compartments (L x W):</b> <b>A</b> = 1-11/16" x 6-1/4" (4.29 x 15.88 cm)						
	<b>A613</b>	6664CB	<b>A-Series</b>	Styrene	10-1/2" x 6-3/16" x 1-9/16" (26.67 x 15.72 x 3.97 cm)	24/ctn
<b>13 Compartments (L x W):</b> <b>A</b> = 1-11/16" x 2.0" (4.29 x 5.08 cm), <b>B</b> = 1-11/16" x 4-1/16" (4.29 x 10.32 cm), <b>C</b> = 3-1/2" x 4-1/16" (8.89 x 10.32 cm)						

\* Adding color to the resins effects the clarity of the finished product

A-SERIES

BOX DIAGRAM	MODEL #	STOCK #	SERIES FAMILY	BOX MATERIAL	DIMENSIONS (INSIDE: L x W x D)	PACKED
<p><b>7 Compartments (L x W):</b> <b>A</b>=1-11/16" x 2.0" (4.29 x 5.08 cm), <b>B</b>= 10-1/2" x 4-1/16" (26.67 x 10.32 cm)</p>	<b>A607</b>	6660CB	<b>A-Series</b>	Styrene	10-1/2" x 6-3/16" x 1-9/16" (26.67 x 15.72 x 3.97 cm)	24/ctn
<p><b>1 Compartment</b></p>	<b>A601</b>	6652DB	<b>A-Series</b>	Styrene	10-1/2" x 6-3/16" x 1-9/16" (26.67 x 15.72 x 3.97 cm)	24/ctn
<p><b>18 Compartments (L x W):</b> <b>A</b>= 1-3/4" x 2-1/16" (4.45 x 5.24 cm)</p>	<b>A618</b>	6666CB	<b>A-Series</b>	Styrene	10-1/2" x 6-3/16" x 1-9/16" (26.67 x 15.72 x 3.97 cm)	24/ctn
<p><b>3 Compartments (L x W):</b> <b>A</b>= 10-1/2" x 2-1/16" (26.67 x 5.24 cm)</p>	<b>A603</b>	6656CB	<b>A-Series</b>	Styrene	10-1/2" x 6-3/16" x 1-9/16" (26.67 x 15.72 x 3.97 cm)	24/ctn
<p><b>12 Compartments (L x W):</b> <b>A</b>= 1-11/16" x 2.0" (4.29 x 5.08 cm), <b>B</b>= 1-11/16" x 4-1/8" (4.29 x 10.48 cm)</p>	<b>A612D</b>	6662DB	<b>A-Series</b>	Styrene	10-1/2" x 6-3/16" x 2-1/4" (26.67 x 15.72 x 5.72 cm)	24/ctn
<p><b>18 Compartments (L x W):</b> <b>A</b>= 1-3/4" x 2-1/16" (4.45 x 5.24 cm)</p>	<b>A618D</b>	6666DB	<b>A-Series</b>	Styrene	10-1/2" x 6-3/16" x 2-1/4" (26.67 x 15.72 x 5.72 cm)	24/ctn
<p><b>1 Compartment</b></p>	<b>A601D</b>	6652DB	<b>A-Series</b>	Styrene	10-1/2" x 6-3/16" x 2-1/4" (26.67 x 15.72 x 5.72 cm)	24/ctn
<p><b>6 Compartments (L x W):</b> <b>A</b>= 1-11/16" x 6-1/4" (4.29 x 15.88 cm)</p>	<b>A606D</b>	6658DB	<b>A-Series</b>	Styrene	10-1/2" x 6-3/16" x 2-1/4" (26.67 x 15.72 x 5.72 cm)	24/ctn
<p><b>24 Compartments (L x W):</b> <b>A</b>= 1-11/16" x 2.0" (4.29 x 5.08 cm), <b>Box has Sliding Lid (Non-Hinged)</b></p>	<b>A924-2</b>	6684CB	<b>A-Series</b>	Styrene	10-9/16" x 8-1/4" x 1-9/16" (26.83 x 20.96 x 3.97 cm)	10/ctn

**SIZE RANGE**

**12-3/4" x 8-1/2" x 2-1/8"** (32.39 x 21.59 x 5.40 cm) — **12-3/4" x 8-1/2" x 2-1/8"** (32.39 x 21.59 x 5.40 cm)

**BOX MATERIAL KEY**







**SYMBOL KEY**

**TP** = Translucent Polypropylene  
**YP** = Yellow Polypropylene  
**WP** = White Polypropylene

**TCP** = Transparent Cellulose Propionate  
**SBMM** = Styrene-Butadiene Methyl Methacrylate  
**SBC** = Styrene-Butadiene Copolymer

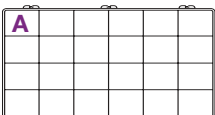
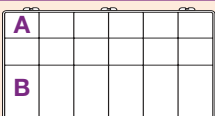
**SP** = Taupe Polypropylene  
**OP** = Orange Polypropylene

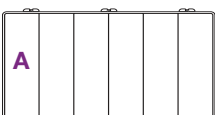
Special Order 



BOX DIAGRAM	MODEL #	STOCK #	SERIES FAMILY	BOX MATERIAL	DIMENSIONS (INSIDE: L x W x D)	PACKED
 1 Compartment	<b>A801</b>	6672CB	<b>A-Series</b>	Styrene	12-3/4" x 8-1/2" x 2-1/8" (32.39 x 21.59 x 5.40 cm)	12/ctn
 12 Compartments (L x W): <b>A=</b> 2-1/16" x 4-3/16" (5.24 x 12.22 cm)	<b>A812</b>	6676CB	<b>A-Series</b>	Styrene	12-3/4" x 8-1/2" x 2-1/8" (32.39 x 21.59 x 5.40 cm)	12/ctn
 24 Compartments (L x W): <b>A=</b> 2-1/16" x 2-1/16" (5.24 x 5.24 cm)	<b>A824</b>	6680CB	<b>A-Series</b>	Styrene	12-3/4" x 8-1/2" x 2-1/8" (32.39 x 21.59 x 5.40 cm)	12/ctn
 18 Compartments (L x W): <b>A=</b> 2-1/16" x 2-1/16" (5.24 x 5.24 cm), <b>B=</b> 2-1/16" x 4-3/16" (5.24 x 12.22 cm)	<b>A818</b> 	6678CB	<b>A-Series</b>	Styrene	12-3/4" x 8-1/2" x 2-1/8" (32.39 x 21.59 x 5.40 cm)	12/ctn
 6 Compartments (L x W): <b>A=</b> 2-1/16" x 8-1/2" (5.24 x 21.59 cm)	<b>A806</b> 	6674CB	<b>A-Series</b>	Styrene	12-3/4" x 8-1/2" x 2-1/8" (32.39 x 21.59 x 5.40 cm)	12/ctn

\* Adding color to the resins effects the clarity of the finished product

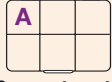

**SIZE RANGE**

**4.0" x 3-2/5" x 1/2"** (10.10 x 8.55 x 1.33 cm) — **6-3/4" x 3-3/16" x 1/2"** (17.15 x 8.10 x 1.27 cm)

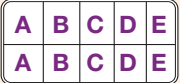
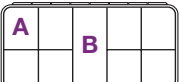
BOX DIAGRAM	MODEL #	STOCK #	SERIES FAMILY	BOX MATERIAL	DIMENSIONS (INSIDE: L x W x D)	PACKED
 1 Compartment	<b>A316-SL</b>	6641CB	<b>A-Series</b>	Styrene	4.0" x 3-2/5" x 1/2" (10.10 x 8.55 x 1.33 cm)	36/ctn
 6 Compartments (L x W): <b>A=</b> 1-1/3" x 1-2/3" (3.30 x 4.21 cm)	<b>A311-SL</b>	6643CB	<b>A-Series</b>	Styrene	4.0" x 3-2/5" x 1/2" (10.10 x 8.55 x 1.33 cm)	36/ctn
 10 Compartments (L x W): <b>A=</b> 3/4" x 1-2/3" (1.93 x 4.21 cm)	<b>A313-SL</b>	6645CB	<b>A-Series</b>	Styrene	4.0" x 3-2/5" x 1/2" (10.10 x 8.55 x 1.33 cm)	36/ctn
 1 Compartment	<b>A216-SL</b> ®	6632CS	<b>A-Series</b>	Styrene	6-3/4" x 3-3/16" x 1/2" (17.15 x 8.10 x 1.27 cm)	36/ctn
 10 Compartments (L x W): <b>A=</b> 1-1/2" x 1-5/8" (3.81 x 4.13 cm), <b>B=</b> 1-7/16" x 1-5/8" (3.65 x 4.13 cm), <b>C=</b> 1-5/16" x 1-5/8" (3.33 x 4.13 cm), <b>D=</b> 1-1/4" x 1-5/8" (3.18 x 4.13 cm), <b>E=</b> 1-1/8" x 1-5/8" (2.86 x 4.13 cm)	<b>A213-SL</b>	6627CS	<b>A-Series</b>	Styrene	6-3/4" x 3-3/16" x 1/2" (17.15 x 8.10 x 1.27 cm)	36/ctn
 9 Compartments (L x W): <b>A=</b> 1-1/8" x 1-5/8" (2.86 x 4.13 cm), <b>B=</b> 1-1/8" x 3-3/8" (2.86 x 8.57 cm)	<b>A210-SL</b> ®	6622CS	<b>A-Series</b>	Styrene	6-3/4" x 3-3/16" x 1/2" (17.15 x 8.10 x 1.27 cm)	36/ctn

From crafts to electronics and more, these translucent clear containers offer easy access and are great for organized storage.



\*Adding color to the resins effects the clarity of the finished product



## Precision - Series



## Styrene Butadiene Methyl Methacrylate

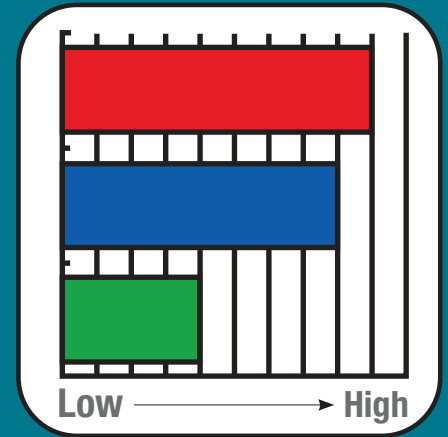

- Clarity\*
- Impact Resistance
- Chemical Resistance

Molded from styrene butadiene methyl methacrylate, this box features transparent clarity and impact resistance. The Precision excels in wet applications with its rust-proof hinge.



\* Adding color to the resins effects the clarity of the finished product



**SIZE RANGE** 3-11/16" x 2-9/16" x 13/16" (9.37 x 6.51 x 2.06 cm) — 8-3/4" x 4-5/16" x 1-1/4" (22.23 x 10.95 x 3.18 cm)

**BOX MATERIAL KEY**

**SYMBOL KEY**

**TP** = Translucent Polypropylene    **TCP** = Transparent Cellulose Propionate    **SP** = Taupe Polypropylene  
**YP** = Yellow Polypropylene    **SBMM** = Styrene-Butadiene Methyl Methacrylate    **OP** = Orange Polypropylene  
**WP** = White Polypropylene    **SBC** = Styrene-Butadiene Copolymer

Special Order 

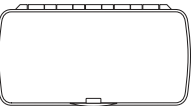
BOX DIAGRAM	MODEL #	STOCK #	SERIES FAMILY	BOX MATERIAL	DIMENSIONS (INSIDE: L x W x D)	PACKED
 1 Compartment	<b>2020-2</b>	6240AA	<b>Precision-Series</b>	SBMM	3-11/16" x 2-9/16" x 13/16" (9.37 x 6.51 x 2.06 cm)	24/ctn
 1 Compartment	<b>3030-2</b>	6730AA	<b>Precision-Series</b>	SBMM	5-5/8" x 3-5/8" x 1-1/8" (14.29 x 9.21 x 2.86 cm)	36/ctn
 1 Compartment	<b>4040-2</b>	6740AA	<b>Precision-Series</b>	SBMM	8-3/4" x 4-5/16" x 1-1/4" (22.23 x 10.95 x 3.18 cm)	24/ctn

Highly recommended for individual seeking a tough compartmentalized case with a clear finish to store and protect valuable parts or everyday items.



PRECISION-SERIES



## Diamondback™ - Series



## Styrene



- Clarity\*
- Impact Resistance
- Chemical Resistance

With a slight architectural edge radius and rounded corners, this box is crystal clear and is excellent for merchandising and general display of products. This box also has small stacking feet to keep displays neater and features an easy open hinge.

US Patent D412,786

\* Adding color to the resins effects the clarity of the finished product

**SIZE RANGE** 4-1/2" x 2-11/16" x 1.0" (11.43 x 6.83 x 2.54 cm) — 7.0" x 3-3/8" x 1-1/8" (17.78 x 8.57 x 2.86 cm)

**BOX MATERIAL KEY**

**SYMBOL KEY**

**TP** = Translucent Polypropylene    **TCP** = Transparent Cellulose Propionate    **SP** = Taupe Polypropylene  
**YP** = Yellow Polypropylene    **SBMM** = Styrene-Butadiene Methyl Methacrylate    **OP** = Orange Polypropylene  
**WP** = White Polypropylene    **SBC** = Styrene-Butadiene Copolymer

Special Order 

BOX DIAGRAM	MODEL #	STOCK #	SERIES FAMILY	BOX MATERIAL	DIMENSIONS (INSIDE: L x W x D)	PACKED
	<b>DB221</b>	6742CD	<b>Diamondback™-Series</b>	Styrene	4-1/2" x 2-11/16" x 1.0" (11.43 x 6.83 x 2.54 cm)	24/ctn
4 Compartments (L x W): <b>A=</b> 2-3/16" x 1-5/16" (5.56 x 3.33 cm)						
	<b>DB228</b>	6746CD	<b>Diamondback™-Series</b>	Styrene	4-1/2" x 2-11/16" x 1.0" (11.43 x 6.83 x 2.54 cm)	24/ctn
8 Compartments (L x W): <b>A=</b> 1-1/16" x 1-5/16" (2.70 x 3.33 cm)						
	<b>DB220</b>	6740CD	<b>Diamondback™-Series</b>	Styrene	4-1/2" x 2-11/16" x 1.0" (11.43 x 6.83 x 2.54 cm)	24/ctn
6 Compartments (L x W): <b>A=</b> 1-5/16" x 1-7/16" (3.33 x 3.65 cm)						
	<b>DB226</b>	6744CD	<b>Diamondback™-Series</b>	Styrene	4-1/2" x 2-11/16" x 1.0" (11.43 x 6.83 x 2.54 cm)	24/ctn
1 Compartment						
	<b>DB216</b>	6732CD	<b>Diamondback™-Series</b>	Styrene	7.0" x 3-3/8" x 1-1/8" (17.78 x 8.57 x 2.86 cm)	25/ctn
1 Compartment						
	<b>DB211</b>	6724CD	<b>Diamondback™-Series</b>	Styrene	7.0" x 3-3/8" x 1-1/8" (17.78 x 8.57 x 2.86 cm)	25/ctn
6 Compartments (L x W): <b>A=</b> 1-1/16" x 3-5/16" (2.70 x 8.41 cm)						
	<b>DB219</b>	6736CD	<b>Diamondback™-Series</b>	Styrene	7.0" x 3-3/8" x 1-1/8" (17.78 x 8.57 x 2.86 cm)	25/ctn
12 Compartments (L x W): <b>A=</b> 1-3/4" x 1-1/16" (4.45 x 2.70 cm)						
	<b>DB210</b>	6722CD	<b>Diamondback™-Series</b>	Styrene	7.0" x 3-3/8" x 1-1/8" (17.78 x 8.57 x 2.86 cm)	25/ctn
9 Compartments (L x W): <b>A=</b> 1-3/8" x 1-5/8" (3.49 x 4.13 cm), <b>B=</b> 1-5/16" x 1-5/8" (3.33 x 4.13 cm), <b>C=</b> 1-5/16" x 3-5/16" (3.33 x 8.41 cm)						
	<b>DB213</b>	6721CD	<b>Diamondback™-Series</b>	Styrene	7.0" x 3-3/8" x 1-1/8" (17.78 x 8.57 x 2.86 cm)	25/ctn
10 Compartments (L x W): <b>A=</b> 1-5/16" x 1-5/8" (3.33 x 4.13 cm)						

**SIZE RANGE** 7.0" x 3-3/8" x 1-1/8" (17.78 x 8.57 x 2.86 cm) — 11.0" x 6-3/8" x 1-9/16" (27.94 x 16.19 x 3.97 cm)

**BOX MATERIAL KEY**

**SYMBOL KEY**



**TP** = Translucent Polypropylene    **TCP** = Transparent Cellulose Propionate    **SP** = Taupe Polypropylene  
**YP** = Yellow Polypropylene    **SBMM** = Styrene-Butadiene Methyl Methacrylate    **OP** = Orange Polypropylene  
**WP** = White Polypropylene    **SBC** = Styrene-Butadiene Copolymer

Special Order 

BOX DIAGRAM	MODEL #	STOCK #	SERIES FAMILY	BOX MATERIAL	DIMENSIONS (INSIDE: L x W x D)	PACKED
	<b>DB217</b>	6734CD	<b>Diamondback™-Series</b>	Styrene	7.0" x 3-3/8" x 1-1/8" (17.78 x 8.57 x 2.86 cm)	25/ctn
7 Compartments (L x W): <b>A</b> = 1-5/16" x 1-5/8" (3.33 x 4.13 cm), <b>B</b> = 4-1/8" x 1-1/8" (10.48 x 2.86 cm)						
	<b>DB201</b>	6710CD	<b>Diamondback™-Series</b>	Styrene	8-7/16" x 4-1/4" x 1-3/16" (21.43 x 10.80 x 3.02 cm)	24/ctn
12 Compartments (L x W): <b>A</b> = 1-5/16" x 1-5/16" (3.33 x 3.33 cm), <b>B</b> = 1-5/16" x 4-1/4" (3.33 x 10.80 cm), <b>C</b> = 1-5/16" x 2-1/16" (3.33 x 5.24 cm)						
	<b>DB203</b>	6712CD	<b>Diamondback™-Series</b>	Styrene	8-7/16" x 4-1/4" x 1-3/16" (21.43 x 10.80 x 3.02 cm)	24/ctn
6 Compartments (L x W): <b>A</b> = 1-3/8" x 4-1/4" (3.49 x 10.80 cm), <b>B</b> = 1-5/16" x 4-1/4" (3.33 x 10.80 cm)						
	<b>DB208</b>	6718CD	<b>Diamondback™-Series</b>	Styrene	8-7/16" x 4-1/4" x 1-3/16" (21.43 x 10.80 x 3.02 cm)	24/ctn
12 Compartments (L x W): <b>A</b> = 1-3/8" x 2-1/16" (3.49 x 5.24 cm)						
	<b>DB200</b>	6708CD	<b>Diamondback™-Series</b>	Styrene	8-7/16" x 4-1/4" x 1-3/16" (21.43 x 10.80 x 3.02 cm)	24/ctn
18 Compartments (L x W): <b>A</b> = 1-3/8" x 1-3/8" (3.49 x 3.49 cm)						
	<b>DB206</b> 	6716CD	<b>Diamondback™-Series</b>	Styrene	8-7/16" x 4-1/4" x 1-3/16" (21.43 x 10.80 x 3.02 cm)	24/ctn
1 Compartment						
	<b>DB204</b>	6714CD	<b>Diamondback™-Series</b>	Styrene	8-7/16" x 4-1/4" x 1-3/16" (21.43 x 10.80 x 3.02 cm)	24/ctn
12 Compartments (L x W): <b>A</b> = 3.0" x 1-3/8" (7.62 x 3.49 cm), <b>B</b> = 1-3/8" x 1-3/8" (3.49 x 3.49 cm), <b>C</b> = 3.0" x 2-3/4" (7.62 x 6.99 cm)						
	<b>DB606</b>	6758CD	<b>Diamondback™-Series</b>	Styrene	11.0" x 6-3/8" x 1-9/16" (27.94 x 16.19 x 3.97 cm)	12/ctn
6 Compartments (L x W): <b>A</b> = 1-3/4" x 6-3/8" (4.45 x 16.19 cm)						

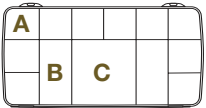

\* Adding color to the resins effects the clarity of the finished product

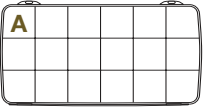
BOX DIAGRAM	MODEL #	STOCK #	SERIES FAMILY	BOX MATERIAL	DIMENSIONS (INSIDE: L x W x D)	PACKED
 <p><b>13 Compartments (L x W):</b> <b>A</b>= 1-7/8" x 2-1/16" (4.76 x 5.24 cm), <b>B</b>= 1-3/4" x 4-1/8" (4.45 x 10.48 cm), <b>C</b>= 3-9/16" x 4-1/8" (9.05 x 10.48 cm)</p>	<b>DB613</b>	6764CD	<b>Diamondback™-Series</b>	Styrene	11.0" x 6-3/8" x 1-9/16" (27.94 x 16.19 x 3.97 cm)	12/ctn
 <p><b>1 Compartment</b></p>	<b>DB601</b> ©	6752CD	<b>Diamondback™-Series</b>	Styrene	11.0" x 6-3/8" x 1-9/16" (27.94 x 16.19 x 3.97 cm)	12/ctn
 <p><b>18 Compartments (L x W):</b> <b>A</b>= 1-3/4" x 2-1/16" (4.45 x 5.24 cm)</p>	<b>DB618</b>	6766CD	<b>Diamondback™-Series</b>	Styrene	11.0" x 6-3/8" x 1-9/16" (27.94 x 16.19 x 3.97 cm)	12/ctn

DIAMONDBACK™ SERIES



Quickly view the contents from the outside with this high clarity compartment box. This series is also FDA approved.

## Mighty-Tuff™ - Series



Just as the name implies, the Mighty-Tuff is tough!

## Cellulose Propionate

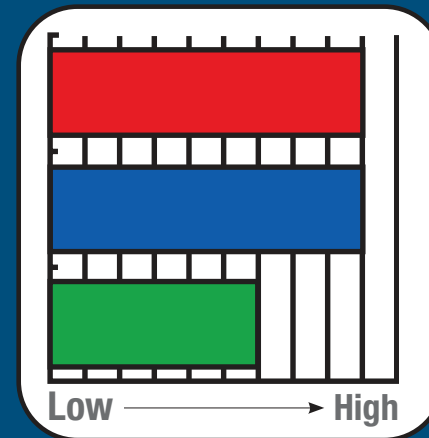

- Clarity\*
- Impact Resistance
- Chemical Resistance

This transparent cellulose propionate material excels in industrial and institutional environments. With a double metal hinge you can be sure that this box will take almost any punishment you can give it.



\* Adding color to the resins effects the clarity of the finished product

**SIZE RANGE** 4-5/16" x 2-5/8" x 1-1/16" (10.95 x 6.67 x 2.70 cm) — 11-15/16" x 5-15/16" x 1-7/16" (30.32 x 15.08 x 3.65 cm)

**BOX MATERIAL KEY**

**SYMBOL KEY**

**TP** = Translucent Polypropylene    **TCP** = Transparent Cellulose Propionate    **SP** = Taupe Polypropylene  
**YP** = Yellow Polypropylene    **SBMM** = Styrene-Butadiene Methyl Methacrylate    **OP** = Orange Polypropylene  
**WP** = White Polypropylene    **SBC** = Styrene-Butadiene Copolymer

Special Order 

BOX DIAGRAM	MODEL #	STOCK #	SERIES FAMILY	BOX MATERIAL	DIMENSIONS (INSIDE: L x W x D)	PACKED
 1 Compartment	<b>5200CL</b>	6230MT	<b>Mighty-Tuff™-Series</b>	TCP	4-5/16" x 2-5/8" x 1-1/16" (10.95 x 6.67 x 2.70 cm)	12/ctn
 2 Compartments (L x W): <b>A</b> = 2-1/8" x 2-5/8" (5.40 x 6.67 cm)	<b>5202CL</b>	6232MT	<b>Mighty-Tuff™-Series</b>	TCP	4-5/16" x 2-5/8" x 1-1/16" (10.95 x 6.67 x 2.70 cm)	12/ctn
 4 Compartments (L x W): <b>A</b> = 2-1/8" x 1-1/4" (5.40 x 3.18 cm)	<b>5204CL</b>	6234MT	<b>Mighty-Tuff™-Series</b>	TCP	4-5/16" x 2-5/8" x 1-1/16" (10.95 x 6.67 x 2.70 cm)	12/ctn
 6 Compartments (L x W): <b>A</b> = 1-3/8" x 1-5/16" (3.49 x 3.33 cm)	<b>5206CL</b> 	6236MT	<b>Mighty-Tuff™-Series</b>	TCP	4-5/16" x 2-5/8" x 1-1/16" (10.95 x 6.67 x 2.70 cm)	12/ctn
 17 Compartments (L x W): <b>A</b> = 1-1/4" x 7/8" (3.18 x 2.22 cm), <b>B</b> = 1-3/16" x 4.0" (3.02 x 10.16 cm)	<b>5126CL</b>	6220MT	<b>Mighty-Tuff™-Series</b>	TCP	7.0" x 4.0" x 1-1/16" (17.78 x 10.16 x 2.70 cm)	12/ctn
 11 Compartments (L x W): <b>A</b> = 1-3/16" x 4.0" (3.02 x 10.16 cm), <b>B</b> = 1-1/4" x 2.0" (3.18 x 5.08 cm), <b>C</b> = 1-1/4" x 7/8" (3.18 x 2.22 cm)	<b>5127CL</b>	6222MT	<b>Mighty-Tuff™-Series</b>	TCP	7.0" x 4.0" x 1-1/16" (17.78 x 10.16 x 2.70 cm)	12/ctn
 6 Compartments (L x W): <b>A</b> = 1-3/16" x 4.0" (3.02 x 10.16 cm)	<b>5128CL</b>	6224MT	<b>Mighty-Tuff™-Series</b>	TCP	7.0" x 4.0" x 1-1/16" (17.78 x 10.16 x 2.70 cm)	12/ctn
 1 Compartment	<b>5129-1</b>	6789CH	<b>Mighty-Tuff™-Series</b>	TCP	11-15/16" x 5-15/16" x 1-7/16" (30.32 x 15.08 x 3.65 cm)	6/ctn
 24 Compartments (L x W): <b>A</b> = 1-7/16" x 1-7/8" (3.65 x 4.76 cm)	<b>5129CL</b>	6226MT	<b>Mighty-Tuff™-Series</b>	TCP	11-15/16" x 5-15/16" x 1-7/16" (30.32 x 15.08 x 3.65 cm)	6/ctn
 6 Compartments (L x W): <b>A</b> = 1-7/16" x 3-15/16" (3.65 x 10.00 cm), <b>B</b> = 8-7/8" x 1-7/8" (22.54 x 4.76 cm), <b>C</b> = 1-7/16" x 1-7/8" (3.65 x 4.76 cm), <b>D</b> = 10-3/8" x 1-7/8" (26.35 x 4.76 cm), <b>E</b> = 5-15/16" x 1-7/8" (15.08 x 4.76 cm)	<b>5130CL</b>	6228MT	<b>Mighty-Tuff™-Series</b>	TCP	11-15/16" x 5-15/16" x 1-7/16" (30.32 x 15.08 x 3.65 cm)	6/ctn

**MIGHTY-TUFF™ SERIES**



M-Series



Polypropylene

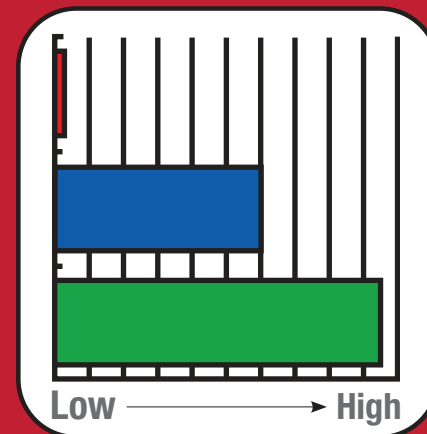

- Clarity\*
- Impact Resistance
- Chemical Resistance

Extra heavy-duty construction makes the polypropylene M-Series boxes tough and durable. These workhorse boxes feature a heavy-duty, heat-sealed hinge and overlapping lid to inhibit dust. Impervious to most household chemicals, solvents, oil and gasoline, these boxes keep items safe and organized.

Our "M-Series" boxes are manufactured in the "safety yellow" color.

**SIZE RANGE** 4-3/8" x 2-5/8" x 1.0" (11.11 x 6.67 x 2.54 cm) — 8.0" x 4.0" x 1-3/16" (20.32 x 10.16 x 3.02 cm)

**BOX MATERIAL KEY**

**SYMBOL KEY**

**TP** = Translucent Polypropylene    **TCP** = Transparent Cellulose Propionate    **SP** = Taupe Polypropylene  
**YP** = Yellow Polypropylene    **SBMM** = Styrene-Butadiene Methyl Methacrylate    **OP** = Orange Polypropylene  
**WP** = White Polypropylene    **SBC** = Styrene-Butadiene Copolymer

Special Order 

BOX DIAGRAM	MODEL #	STOCK #	SERIES FAMILY	BOX MATERIAL	DIMENSIONS (INSIDE: L x W x D)	PACKED
 4 Compartments (L x W): <b>A</b> = 2-3/16" x 1-5/16" (5.56 x 3.33 cm)	<b>M221</b> 	6706TF	<b>M-Series</b>	YP	4-3/8" x 2-5/8" x 1.0" (11.11 x 6.67 x 2.54 cm)	36/ctn
 6 Compartments (L x W): <b>A</b> = 1-3/8" x 1-1/4" (3.49 x 3.18 cm)	<b>M220</b> 	6704TF	<b>M-Series</b>	YP	4-3/8" x 2-5/8" x 1.0" (11.11 x 6.67 x 2.54 cm)	36/ctn
 5 Compartments (L x W): <b>A</b> = 1-5/16" x 3-3/16" (3.33 x 8.10 cm)	<b>M215</b> 	6702TF	<b>M-Series</b>	YP	6-3/4" x 3-3/16" x 1-3/16" (17.15 x 8.10 x 3.02 cm)	36/ctn
 9 Compartments (L x W): <b>A</b> = 1-5/16" x 1-9/16" (3.33 x 3.97 cm), <b>B</b> = 1-1/8" x 3-3/16" (2.86 x 8.10 cm)	<b>M210</b>	6698TF	<b>M-Series</b>	YP	6-3/4" x 3-3/16" x 1-3/16" (17.15 x 8.10 x 3.02 cm)	36/ctn
 18 Compartments (L x W): <b>A</b> = 1-1/4" x 1-1/4" (3.18 x 3.18 cm)	<b>M200</b>	6690TF	<b>M-Series</b>	YP	8.0" x 4.0" x 1-3/16" (20.32 x 10.16 x 3.02 cm)	24/ctn
 12 Compartments (L x W): <b>A</b> = 1-1/4" x 1-15/16" (3.18 x 4.92 cm)	<b>M208</b>	6696TF	<b>M-Series</b>	YP	8.0" x 4.0" x 1-3/16" (20.32 x 10.16 x 3.02 cm)	24/ctn
 12 Compartments (L x W): <b>A</b> = 1-5/16" x 1-5/16" (3.33 x 3.33 cm), <b>B</b> = 1-5/16" x 4.0" (3.33 x 10.16 cm), <b>C</b> = 1-5/16" x 2.06" (3.33 x 5.08 cm)	<b>M201</b>	6692TF	<b>M-Series</b>	YP	8.0" x 4.0" x 1-3/16" (20.32 x 10.16 x 3.02 cm)	24/ctn
 6 Compartments (L x W): <b>A</b> = 1-1/4" x 4.0" (3.18 x 10.16 cm)	<b>M203</b>	6694TF	<b>M-Series</b>	YP	8.0" x 4.0" x 1-3/16" (20.32 x 10.16 x 3.02 cm)	24/ctn

**M-SERIES**

**SIZE RANGE**

**10-1/2" x 6-3/16" x 1-9/16"** (26.67 x 15.72 x 3.97 cm) — **12-3/4" x 8-1/2" x 2-1/8"** (32.39 x 21.59 x 5.40 cm)

**BOX MATERIAL KEY**

**SYMBOL KEY**

**TP** = Translucent Polypropylene  
**YP** = Yellow Polypropylene  
**WP** = White Polypropylene

**TCP** = Transparent Cellulose Propionate  
**SBMM** = Styrene-Butadiene Methyl Methacrylate  
**SBC** = Styrene-Butadiene Copolymer

**SP** = Taupe Polypropylene  
**OP** = Orange Polypropylene

Special Order 

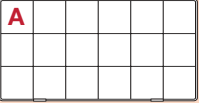
BOX DIAGRAM	MODEL #	STOCK #	SERIES FAMILY	BOX MATERIAL	DIMENSIONS (INSIDE: L x W x D)	PACKED
	<b>M616R</b> 	6713TF	<b>M-Series</b>	YP	10-1/2" x 6-3/16" x 1-9/16" (26.67 x 15.72 x 3.97 cm)	24/ctn
<b>4 Compartments &amp; 12 Removable Dividers (L x W): A= 10-3/8" x 1-1/2" (26.35 x 3.81 cm)</b>						
	<b>M623</b>	6716TF	<b>M-Series</b>	YP	10-1/2" x 6-3/16" x 1-9/16" (26.67 x 15.72 x 3.97 cm)	24/ctn
<b>13 Compartments (L x W): A= 10-3/8" x 2-5/8" (26.35 x 6.67 cm), B= 1-11/16" x 1-5/16" (4.29 x 3.33 cm), C= 1-11/16" x 2.0" (4.29 x 5.08 cm)</b>						
	<b>M612</b>	6712TF	<b>M-Series</b>	YP	10-1/2" x 6-3/16" x 1-9/16" (26.67 x 15.72 x 3.97 cm)	24/ctn
<b>12 Compartments (L x W): A= 1-11/16" x 2.0" (4.29 x 5.08 cm), B= 1-11/16" x 4-1/8" (4.29 x 10.48 cm)</b>						
	<b>M602</b>	6708TF	<b>M-Series</b>	YP	10-1/2" x 6-3/16" x 1-9/16" (26.67 x 15.72 x 3.97 cm)	24/ctn
<b>12 Compartments (L x W): A= 1-11/16" x 3-1/16" (4.29 x 7.78 cm)</b>						
	<b>M606</b>	6710TF	<b>M-Series</b>	YP	10-1/2" x 6-3/16" x 1-9/16" (26.67 x 15.72 x 3.97 cm)	24/ctn
<b>6 Compartments (L x W): A= 1-11/16" x 6-1/4" (4.29 x 15.88 cm)</b>						
	<b>M618</b>	6714TF	<b>M-Series</b>	YP	10-1/2" x 6-3/16" x 1-9/16" (26.67 x 15.72 x 3.97 cm)	24/ctn
<b>18 Compartments (L x W): A= 1-3/4" x 2-1/16" (4.45 x 5.24 cm)</b>						
	<b>M612D</b> 	6712DB	<b>M-Series</b>	YP	10-1/2" x 6-3/16" x 2-1/4" (26.67 x 15.72 x 5.72 cm)	24/ctn
<b>12 Compartments (L x W): A= 1-11/16" x 2.0" (4.29 x 5.08 cm), B= 1-11/16" x 4-1/8" (4.29 x 10.48 cm)</b>						
	<b>M618D</b> 	6714DB	<b>M-Series</b>	YP	10-1/2" x 6-3/16" x 2-1/4" (26.67 x 15.72 x 5.72 cm)	24/ctn
<b>18 Compartments (L x W): A= 1-3/4" x 2-1/16" (4.45 x 5.24 cm)</b>						



\* Adding color to the resins effects the clarity of the finished product

BOX DIAGRAM	MODEL #	STOCK #	SERIES FAMILY	BOX MATERIAL	DIMENSIONS (INSIDE: L x W x D)	PACKED
 <p><b>6 Compartments (L x W): A= 1-11/16" x 6-1/4" (4.29 x 15.88 cm)</b></p>	<b>M606D</b> 	6710DB	<b>M-Series</b>	YP	10-1/2" x 6-3/16" x 2-1/4" (26.67 x 15.72 x 5.72 cm)	24/ctn
 <p><b>8 Compartments (L x W): A= 2-1/16" x 8-1/2" (5.24 x 21.59 cm), B= 2-1/16" x 4-1/8" (5.24 x 10.48 cm), C= 2-1/16" x 2.0" (5.24 x 5.08 cm)</b></p>	<b>M808</b> 	6720TF	<b>M-Series</b>	YP	12-1/2" x 8-1/4" x 2-1/4" (31.75 x 20.96 x 5.72 cm)	12/ctn
 <p><b>12 Compartments (L x W): A= 2-1/16" x 4-3/16" (5.24 x 12.22 cm)</b></p>	<b>M812</b>	6722TF	<b>M-Series</b>	YP	12-3/4" x 8-1/2" x 2-1/8" (32.39 x 21.59 x 5.40 cm)	12/ctn
 <p><b>24 Compartments (L x W): A= 2-1/16" x 2-1/16" (5.24 x 5.24 cm)</b></p>	<b>M824</b>	6726TF	<b>M-Series</b>	YP	12-3/4" x 8-1/2" x 2-1/8" (32.39 x 21.59 x 5.40 cm)	12/ctn
 <p><b>18 Compartments (L x W): A= 2-1/16" x 2-1/16" (5.24 x 5.24 cm), B= 2-1/16" x 4-3/16" (5.24 x 12.22 cm)</b></p>	<b>M818</b>	6724TF	<b>M-Series</b>	YP	12-3/4" x 8-1/2" x 2-1/8" (32.39 x 21.59 x 5.40 cm)	12/ctn
 <p><b>6 Compartments (L x W): A= 2-1/16" x 8-1/2" (5.24 x 21.59 cm)</b></p>	<b>M806</b>	6718TF	<b>M-Series</b>	YP	12-3/4" x 8-1/2" x 2-1/8" (32.39 x 21.59 x 5.40 cm)	12/ctn

# M-SERIES



V-Series



## Polypropylene

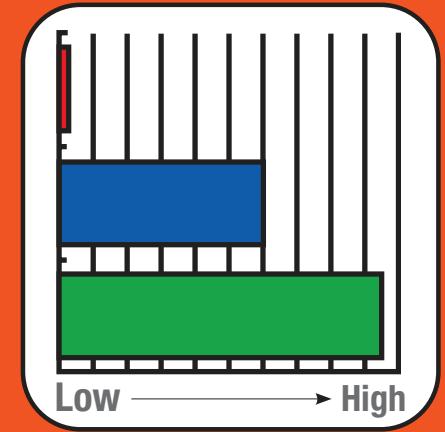

- Clarity\*
- Impact Resistance
- Chemical Resistance

V-Series Boxes incorporate living hinge and latch construction with dual positive snap-shut features. These single compartment boxes are excellent for "kits" and storing small instruments. *These boxes can be autoclaved!*



**SIZE RANGE** 6-7/8" x 2-1/16" x 1.0" (17.46 x 5.24 x 2.54 cm) — 17.0" x 7-1/8" x 2.0" (43.18 x 18.10 x 5.08 cm)

**BOX MATERIAL KEY**

**SYMBOL KEY**

**TP** = Translucent Polypropylene  
**YP** = Yellow Polypropylene  
**WP** = White Polypropylene

**TCP** = Transparent Cellulose Propionate  
**SBMM** = Styrene-Butadiene Methyl Methacrylate  
**SBC** = Styrene-Butadiene Copolymer

**SP** = Taupe Polypropylene  
**OP** = Orange Polypropylene

Special Order 

BOX DIAGRAM	MODEL #	STOCK #	SERIES FAMILY	BOX MATERIAL	DIMENSIONS (INSIDE: L x W x D)	PACKED
 1 Compartment	<b>V301</b>	6142VB	<b>V-Series</b>	OP	6-7/8" x 2-1/16" x 1.0" (17.46 x 5.24 x 2.54 cm)	36/ctn
 1 Compartment	<b>V301PT</b>	6650VC	<b>V-Series</b>	SP	6-7/8" x 2-1/16" x 1.0" (17.46 x 5.24 x 2.54 cm)	36/ctn
 1 Compartment	<b>V401</b>	6152VB	<b>V-Series</b>	SP	8-1/8" x 4-1/8" x 1-3/16" (20.64 x 10.48 x 3.02 cm)	24/ctn
 2 Compartments (L x W): <b>A=</b> 8-1/4" x 1-1/4" (20.96 x 10.16 cm)	<b>V402-2</b> 	6655VA	<b>V-Series</b>	SP	8-1/8" x 4-1/8" x 1-3/16" (20.64 x 10.48 x 3.02 cm)	24/ctn
 1 Compartment	<b>V401D-2</b>	6654DV	<b>V-Series</b>	SP	8-1/8" x 4-1/8" x 2-5/8" (20.64 x 10.48 x 6.67 cm)	24/ctn
 1 Compartment	<b>V501</b>	6160VB	<b>V-Series</b>	SP	10.0" x 4-1/4" x 1-1/2" (25.40 x 10.80 x 3.81 cm)	24/ctn
 6 Compartments (L x W): <b>A=</b> 1-5/8" x 4-1/4" (4.13 x 10.80 cm)	<b>V506-2</b> 	6660VA	<b>V-Series</b>	SP	10.0" x 4-1/4" x 1-1/2" (25.40 x 10.80 x 3.81 cm)	24/ctn
 1 Compartment	<b>V601</b>	6667VB	<b>V-Series</b>	SP	13-1/2" x 5-3/4" x 2.0" (34.29 x 14.61 x 5.08 cm)	12/ctn
 1 Compartment	<b>V701</b>	6172VB	<b>V-Series</b>	SP	17.0" x 7-1/8" x 2.0" (43.18 x 18.10 x 5.08 cm)	6/ctn

V-SERIES



## Tuff Tainer®-Series



## Polypropylene



- Clarity\*
- Impact Resistance
- Chemical Resistance

The Tuff Tainer® is made with polypropylene and features a detachable lid and movable dividers that allow you to configure the compartment space to your liking. The majority of these boxes include two positive locking latches and will resist most common chemicals, gasoline and oil.

**SIZE RANGE** 4-5/16" x 2-5/8" x 1-1/8" (10.95 x 6.67 x 2.86 cm) — 10-1/2" x 6-1/4" x 1-1/2" (26.67 x 15.88 x 3.81 cm)

**BOX MATERIAL KEY**

**SYMBOL KEY**

**TP** = Translucent Polypropylene    **TCP** = Transparent Cellulose Propionate    **SP** = Taupe Polypropylene  
**YP** = Yellow Polypropylene    **SBMM** = Styrene-Butadiene Methyl Methacrylate    **OP** = Orange Polypropylene  
**WP** = White Polypropylene    **SBC** = Styrene-Butadiene Copolymer

Special Order 

**TUFF TAINER®-SERIES**

BOX DIAGRAM	MODEL #	STOCK #	SERIES FAMILY	BOX MATERIAL	DIMENSIONS (INSIDE: L x W x D)	DIVIDER # / BULK ORDER #	PACKED
	<b>T1002</b>	6709TE	<b>Tuff Tainer®-Series</b>	TP	4-5/16" x 2-5/8" x 1-1/8" (10.95 x 6.67 x 2.86 cm)	<b>1012DP / 601331</b>	12/ctn
4 Compartments & 2 Removable Dividers (L x W): <b>A=</b> 3.0" x 1-1/4" (7.62 x 3.18 cm), <b>B=</b> 1-1/4" x 1-1/4" (10.16 x 10.16 cm)							
	<b>T2003</b>	6703TE	<b>Tuff Tainer®-Series</b>	TP	6-11/16" x 3-5/16" x 1-5/16" (16.99 x 8.41 x 3.33 cm)	<b>2012DP / 601321</b>	12/ctn
3 Compartments & 15 Removable Dividers (L x W): <b>A=</b> 6-11/16" x 1-1/16" (16.99 x 2.70 cm)							
	<b>T3003</b>	6707TE	<b>Tuff Tainer®-Series</b>	TP	9.0" x 4.0" x 1-1/4" (22.86 x 10.16 x 3.18 cm)	<b>3715DP / 601320</b>	12/ctn
3 Compartments & 15 Removable Dividers (L x W): <b>A=</b> 8-7/8" x 1-3/8" (22.54 x 3.49 cm)							
	<b>T4004</b>	6744TE	<b>Tuff Tainer®-Series</b>	TP	10-1/2" x 6-1/4" x 1-1/2" (26.67 x 15.88 x 3.81 cm)	<b>601973</b>	6/ctn
5 Compartments & 15 Removable Dividers (L x W): <b>A=</b> 1-3/4" x 6-5/8" (4.45 x 16.38 cm), <b>B=</b> 5.0" x 6-5/8" (12.70 x 16.38 cm)							
	<b>T4007</b>	6747TE	<b>Tuff Tainer®-Series</b>	TP	10-1/2" x 6-1/4" x 1-1/2" (26.67 x 15.88 x 3.81 cm)	<b>4715DP / 601370</b>	6/ctn
4 Compartments, Black Mechanical Latches & 12 Removable Dividers (L x W): <b>A=</b> 1-11/16" x 6-1/4" (4.29 x 15.87 cm)							
	<b>T4007AT</b>	6748TE	<b>Tuff Tainer®-Series</b>	TP	10-1/2" x 6-1/4" x 1-1/2" (26.67 x 15.88 x 3.81 cm)	<b>601916</b>	6/ctn
4 Compartments, Silver Mechanical Latches & 12 Removable Anti-Tarnish Dividers (L x W): <b>A=</b> 1-11/16" x 6-1/4" (4.29 x 15.87 cm)							
	<b>T4008</b>	6749TE	<b>Tuff Tainer®-Series</b>	TP	10-1/2" x 6-1/4" x 1-1/2" (26.67 x 15.88 x 3.81 cm)	<b>601917</b>	6/ctn
4 Compartments, Black Mechanical Latches & 12 Removable Dividers (L x W): <b>A=</b> 1-11/16" x 6-1/4" (4.29 x 15.87 cm)							
	<b>T4000</b>	6734TE	<b>Tuff Tainer®-Series</b>	TP	10-1/2" x 6-1/4" x 1-1/2" (26.67 x 15.88 x 3.81 cm)	-	6/ctn
1 Compartment							

**SIZE RANGE**

**12.0" x 4.0" x 1-1/16"** (30.48 x 10.16 x 2.70 cm) — **15-1/4" x 8-7/8" x 3.0"** (38.74 x 22.54 x 7.62 cm)

**BOX MATERIAL KEY**

**TP** = Translucent Polypropylene    **TCP** = Transparent Cellulose Propionate    **SP** = Taupe Polypropylene  
**YP** = Yellow Polypropylene    **SBMM** = Styrene-Butadiene Methyl Methacrylate    **OP** = Orange Polypropylene  
**WP** = White Polypropylene    **SBC** = Styrene-Butadiene Copolymer

**SYMBOL KEY**

Special Order 

BOX DIAGRAM	MODEL #	STOCK #	SERIES FAMILY	BOX MATERIAL	DIMENSIONS (INSIDE: L x W x D)	DIVIDER # / BULK ORDER #	PACKED
 1 Compartment	<b>T3011</b>	6711TE	<b>Tuff Tainer®-Series</b>	TP	12.0" x 4.0" x 1-1/16" (30.48 x 10.16 x 2.70 cm)	-	6/ctn
 3 Compartments & 15 Removable Dividers (L x W): <b>A</b> = 13-11/16" x 2-1/8" (34.77 x 3.40 cm), <b>B</b> = 13-11/16" x 4-1/8" (34.77 x 10.48 cm)	<b>T5003</b>	6753TE	<b>Tuff Tainer®-Series</b>	TP	13-11/16" x 8-3/16" x 1-3/4" (34.77 x 20.80 x 4.45 cm)	<b>601975</b>	6/ctn
 4 Compartments, Black Mechanical Latches & 18 Removable Dividers (L x W): <b>A</b> = 13-11/16" x 2.0" (34.77 x 5.08 cm), <b>B</b> = 13-11/16" x 1-11/16" (34.77 x 4.29 cm)	<b>T5007</b>	6757TE	<b>Tuff Tainer®-Series</b>	TP	13-11/16" x 8-3/16" x 1-3/4" (34.77 x 20.80 x 4.45 cm)	<b>5712DP / 601365</b>	6/ctn
 4 Compartments, Black Mechanical Latches & 18 Removable Dividers (L x W): <b>A</b> = 13-11/16" x 2.0" (34.77 x 5.08 cm), <b>B</b> = 13-11/16" x 1-11/16" (34.77 x 4.29 cm)	<b>T5008</b>	6768TE	<b>Tuff Tainer®-Series</b>	TP	13-11/16" x 8-3/16" x 1-3/4" (34.77 x 20.80 x 4.45 cm)	-	6/ctn
 4 Compartments, Silver Mechanical Latches & 18 Removable Dividers (L x W): <b>A</b> = 13-11/16" x 2.0" (34.77 x 5.08 cm), <b>B</b> = 13-11/16" x 1-11/16" (34.77 x 4.29 cm)	<b>T5007AT</b>	6758TE	<b>Tuff Tainer®-Series</b>	TP	13-11/16" x 8-3/16" x 1-3/4" (34.77 x 20.80 x 4.45 cm)	<b>5715DP</b>	6/ctn
 6 Compartments & 28 Removable Dividers (L x W): <b>A</b> = 15-5/16" x 2.0" (38.89 x 5.08 cm), <b>B</b> = 3-1/4" x 2.0" (8.26 x 5.08 cm), <b>C</b> = 8-1/2" x 2.0" (21.59 x 5.08 cm)	<b>T6004</b>	6760TE	<b>Tuff Tainer®-Series</b>	TP	15-1/4" x 8-7/8" x 1-3/8" (38.74 x 22.54 x 3.49 cm)	<b>6012DP / 601329</b>	6/ctn
 6 Compartments & 3 Removable Dividers (L x W): <b>A</b> = 15-1/4" x 4-1/2" (38.74 x 11.43 cm), <b>B</b> = 15-1/4" x 2-1/8" (38.74 x 5.40 cm), <b>C</b> = 3-3/4" x 2-1/8" (9.53 x 5.40 cm), <b>D</b> = 3-3/4" x 1-1/2" (9.53 x 3.81 cm)	<b>T7003</b>	6773TE	<b>Tuff Tainer®-Series</b>	TP	15-1/4" x 8-7/8" x 3.0" (38.74 x 22.54 x 7.62 cm)	<b>7012DP / 601332</b>	6/ctn

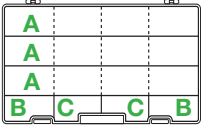
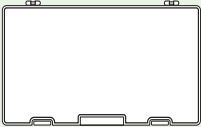

BOX DIAGRAM	MODEL #	STOCK #	SERIES FAMILY	BOX MATERIAL	DIMENSIONS (INSIDE: L x W x D)	DIVIDER # / BULK ORDER #	PACKED
 <p>7 Compartments &amp; 9 Removable Dividers (L x W): <b>A</b>= 15-1/4" x 2-3/16" (38.74 x 5.56 cm), <b>B</b>= 3-3/4" x 2-1/8" (9.52 x 5.40 cm), <b>C</b>= 3-3/4" x 2-1/8" (9.52 x 5.40 cm)</p>	<b>T7004</b>	6774TE	<b>Tuff Tainer®-Series</b>	TP	15-1/4" x 8-7/8" x 3.0" (38.74 x 22.54 x 7.62 cm)	<b>7012DP / 601332</b>	6/ctn
 <p>1 Compartment</p>	<b>T7000</b>	6770TE	<b>Tuff Tainer®-Series</b>	TP	15-1/4" x 8-7/8" x 3.0" (38.74 x 22.54 x 7.62 cm)	-	6/ctn

\* Adding color to the resins effects the clarity of the finished product



# TUFF TAINER® - WATERPROOF BOXES



Waterproof Tuff Tainers are clear, open core compartment boxes that are equipped with tight sealing latches and a waterproof gasket seal. Great for protecting valuable electronic equipment and other water sensitive items.







**SIZE RANGE** 7-5/8" x 3-9/16" x 1.0" (19.38 x 9.05 x 2.54 cm) — 12-1/2" x 7-1/2" x 2-5/16" (31.75 x 19.05 x 5.88 cm)

**BOX MATERIAL KEY**

**SYMBOL KEY**

**TP** = Translucent Polypropylene    **TCP** = Transparent Cellulose Propionate    **SP** = Taupe Polypropylene  
**YP** = Yellow Polypropylene    **SBMM** = Styrene-Butadiene Methyl Methacrylate    **OP** = Orange Polypropylene  
**WP** = White Polypropylene    **SBC** = Styrene-Butadiene Copolymer

Special Order 

BOX DIAGRAM	MODEL #	STOCK #	SERIES FAMILY	BOX MATERIAL	DIMENSIONS (INSIDE: L x W x D)	PACKED
 1 Compartment	<b>WT3000</b>	6723TE	<b>Waterproof</b> Tuff Tainer®-Series	TP	7-5/8" x 3-9/16" x 1.0" (19.38 x 9.05 x 2.54 cm)	12/ctn
 1 Compartment	<b>WT4000</b>	6741TE	<b>Waterproof</b> Tuff Tainer®-Series	TP	9-5/16" x 5-13/16" x 1-1/4" (23.65 x 14.77 x 3.18 cm)	6/ctn
 1 Compartment	<b>WT5000</b>	6750TE	<b>Waterproof</b> Tuff Tainer®-Series	TP	12-1/2" x 7-1/2" x 1-7/16" (31.75 x 19.05 x 3.65 cm)	6/ctn
 1 Compartment	<b>WT5001</b>	6751TE	<b>Waterproof</b> Tuff Tainer®-Series	TP	12-1/2" x 7-1/2" x 2-5/16" (31.75 x 19.05 x 5.88 cm)	6/ctn

\* Adding color to the resins effects the clarity of the finished product



More Waterproof Tuff Tainer information on pages 48-49



K-Series

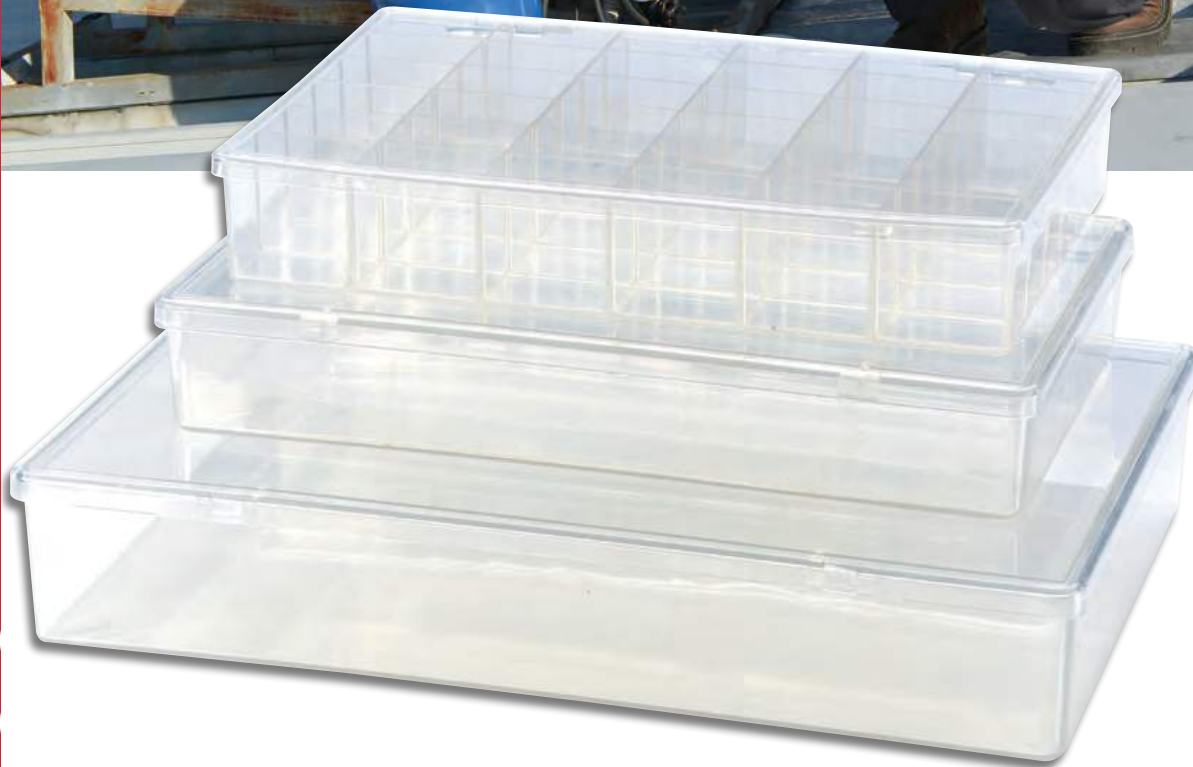

## Styrene Butadiene Copolymer



- Clarity\*
- Impact Resistance
- Chemical Resistance

Noted for heavy-duty application, this styrene butadiene copolymer box has excellent impact, scratch-resistant and transparent properties.







**SIZE RANGE** 4-3/8" x 2-5/8" x 1.0" (11.11 x 6.67 x 2.54 cm) — 8.0" x 4.0" x 1-3/16" (20.32 x 10.16 x 3.02 cm)

**BOX MATERIAL KEY**

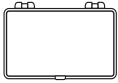
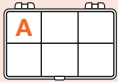
**SYMBOL KEY**

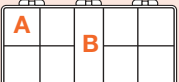
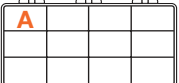
**TP** = Translucent Polypropylene    **TCP** = Transparent Cellulose Propionate    **SP** = Taupe Polypropylene  
**YP** = Yellow Polypropylene    **SBMM** = Styrene-Butadiene Methyl Methacrylate    **OP** = Orange Polypropylene  
**WP** = White Polypropylene    **SBC** = Styrene-Butadiene Copolymer

Special Order 

BOX DIAGRAM	MODEL #	STOCK #	SERIES FAMILY	BOX MATERIAL	DIMENSIONS (INSIDE: L x W x D)	PACKED
 1 Compartment	<b>K226</b>	6644KB	<b>K-Series</b>	SBC	4-3/8" x 2-5/8" x 1.0" (11.11 x 6.67 x 2.54 cm)	36/ctn
 6 Compartments (L x W): <b>A</b> = 1-3/8" x 1-1/4" (3.49 x 3.18 cm)	<b>K220</b>	6640KB	<b>K-Series</b>	SBC	4-3/8" x 2-5/8" x 1.0" (11.11 x 6.67 x 2.54 cm)	36/ctn
 5 Compartments (L x W): <b>A</b> = 1-5/16" x 3-3/16" (3.33 x 8.10 cm)	<b>K215</b>	6630KB	<b>K-Series</b>	SBC	6-3/4" x 3-3/16" x 1-3/16" (17.15 x 8.10 x 3.02 cm)	36/ctn
 9 Compartments (L x W): <b>A</b> = 1-5/16" x 1-9/16" (3.33 x 3.97 cm), <b>B</b> = 1-1/8" x 3-3/16" (2.86 x 8.10 cm)	<b>K210</b>	6622KB	<b>K-Series</b>	SBC	6-3/4" x 3-3/16" x 1-3/16" (17.15 x 8.10 x 3.02 cm)	36/ctn
 12 Compartments (L x W): <b>A</b> = 1-7/16" x 1-1/16" (3.65 x 2.70 cm)	<b>K219</b>	6636KB	<b>K-Series</b>	SBC	6-3/4" x 3-3/16" x 1-3/16" (17.15 x 8.10 x 3.02 cm)	36/ctn
 1 Compartment	<b>K216</b>	6632KB	<b>K-Series</b>	SBC	6-3/4" x 3-3/16" x 1-3/16" (17.15 x 8.10 x 3.02 cm)	36/ctn
 1 Compartment	<b>K701</b>	6670KB	<b>K-Series</b>	SBC	6-7/8" x 2-1/16" x 1.0" (17.46 x 5.24 x 2.54 cm)	36/ctn
 1 Compartment	<b>K206</b>	6616KB	<b>K-Series</b>	SBC	8.0" x 4.0" x 1-3/16" (20.32 x 10.16 x 3.02 cm)	24/ctn
 18 Compartments (L x W): <b>A</b> = 1-1/4" x 1-1/4" (3.18 x 3.18 cm)	<b>K200</b>	6608KB	<b>K-Series</b>	SBC	8.0" x 4.0" x 1-3/16" (20.32 x 10.16 x 3.02 cm)	24/ctn

**K-SERIES**

**SIZE RANGE**

**8.0" x 4.0" x 1-3/16"** (20.32 x 10.16 x 3.02 cm) — **12-3/4" x 8-1/2" x 2-1/8"** (32.39 x 21.59 x 5.40 cm)

**BOX MATERIAL KEY**





**SYMBOL KEY**

**TP** = Translucent Polypropylene  
**YP** = Yellow Polypropylene  
**WP** = White Polypropylene



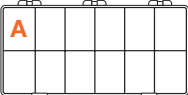
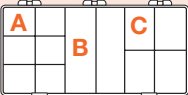
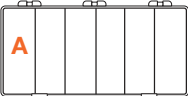
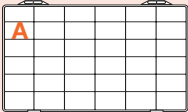

**TCP** = Transparent Cellulose Propionate  
**SBMM** = Styrene-Butadiene Methyl Methacrylate  
**SBC** = Styrene-Butadiene Copolymer

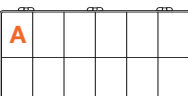
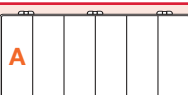
**SP** = Taupe Polypropylene  
**OP** = Orange Polypropylene

Special Order 

BOX DIAGRAM	MODEL #	STOCK #	SERIES FAMILY	BOX MATERIAL	DIMENSIONS (INSIDE: L x W x D)	PACKED
 12 Compartments (L x W): <b>A</b> = 1-1/4" x 1-15/16" (3.18 x 4.92 cm)	<b>K208</b>	6618KB	<b>K-Series</b>	SBC	8.0" x 4.0" x 1-3/16" (20.32 x 10.16 x 3.02 cm)	24/ctn
 12 Compartments (L x W): <b>A</b> = 1-5/16" x 1-5/16" (3.33 x 3.33 cm), <b>B</b> = 1-5/16" x 4.0" (3.33 x 10.16 cm), <b>C</b> = 1-5/16" x 2.0" (3.33 x 5.08 cm)	<b>K201</b>	6610KB	<b>K-Series</b>	SBC	8.0" x 4.0" x 1-3/16" (20.32 x 10.16 x 3.02 cm)	24/ctn
 6 Compartments (L x W): <b>A</b> = 1-1/4" x 4.0" (3.18 x 10.16 cm)	<b>K203</b>	6612KB	<b>K-Series</b>	SBC	8.0" x 4.0" x 1-3/16" (20.32 x 10.16 x 3.02 cm)	24/ctn
 36 Compartments (L x W): <b>A</b> = 1-9/16" x 1-1/16" (3.97 x 2.70 cm)	<b>K166-36</b>	6606KB	<b>K-Series</b>	SBC	9-5/8" x 6-9/16" x 1-1/2" (24.45 x 16.69 x 3.81 cm)	24/ctn
 4 Compartments 12 Removable Dividers (L x W): <b>A</b> = 10-3/8" x 1-1/2" (26.35 x 3.81 cm)	<b>K616R</b> 	6665KB	<b>K-Series</b>	SBC	10-1/2" x 6-3/16" x 1-9/16" (26.67 x 15.72 x 3.97 cm)	24/ctn
 13 Compartments (L x W): <b>A</b> = 10-3/8" x 2-5/8" (26.35 x 6.67 cm), <b>B</b> = 1-11/16" x 1-5/16" (4.29 x 3.33 cm), <b>C</b> = 1-11/16" x 2.0" (4.29 x 5.08 cm)	<b>K623</b> 	6668KB	<b>K-Series</b>	SBC	10-1/2" x 6-3/16" x 1-9/16" (26.67 x 15.72 x 3.97 cm)	24/ctn
 12 Compartments (L x W): <b>A</b> = 1-11/16" x 3-1/16" (4.29 x 7.78 cm)	<b>K602</b>	6654KB	<b>K-Series</b>	SBC	10-1/2" x 6-3/16" x 1-9/16" (26.67 x 15.72 x 3.97 cm)	24/ctn
 6 Compartments (L x W): <b>A</b> = 1-11/16" x 6-1/4" (4.29 x 15.88 cm)	<b>K606</b>	6658KB	<b>K-Series</b>	SBC	10-1/2" x 6-3/16" x 1-9/16" (26.67 x 15.72 x 3.97 cm)	24/ctn

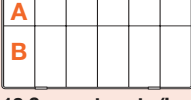

BOX DIAGRAM	MODEL #	STOCK #	SERIES FAMILY	BOX MATERIAL	DIMENSIONS (INSIDE: L x W x D)	PACKED
	<b>K607</b> ©	6660KB	<b>K-Series</b>	SBC	10-1/2" x 6-3/16" x 1-9/16" (26.67 x 15.72 x 3.97 cm)	24/ctn
<b>7 Compartments (L x W): A= 1-11/16" x 2.0" (4.29 x 5.08 cm), B= 10-1/2" x 4-1/16" (26.67 x 10.32 cm)</b>						
	<b>K601</b>	6652KB	<b>K-Series</b>	SBC	10-1/2" x 6-3/16" x 1-9/16" (26.67 x 15.72 x 3.97 cm)	24/ctn
<b>1 Compartment</b>						
	<b>K618</b>	6666KB	<b>K-Series</b>	SBC	10-1/2" x 6-3/16" x 1-9/16" (26.67 x 15.72 x 3.97 cm)	24/ctn
<b>18 Compartments (L x W): A= 1-3/4" x 2-1/16" (4.45 x 5.24 cm)</b>						
	<b>K612D</b> ©	6663DK	<b>K-Series</b>	SBC	10-1/2" x 6-3/16" x 2-1/4" (26.67 x 15.72 x 5.72 cm)	24/ctn
<b>12 Compartments (L x W): A= 1-11/16" x 2.0" (4.29 x 5.08 cm), B= 1-11/16" x 4-1/8" (4.29 x 10.48 cm)</b>						
	<b>K618D</b> ©	6666DK	<b>K-Series</b>	SBC	10-1/2" x 6-3/16" x 2-1/4" (26.67 x 15.72 x 5.72 cm)	24/ctn
<b>18 Compartments (L x W): A= 1-3/4" x 2-1/16" (4.45 x 5.24 cm)</b>						
	<b>K606D</b> ©	6658DK	<b>K-Series</b>	SBC	10-1/2" x 6-3/16" x 2-1/4" (26.67 x 15.72 x 5.72 cm)	24/ctn
<b>6 Compartments (L x W): A= 1-11/16" x 6-1/4" (4.29 x 15.88 cm)</b>						
	<b>K601D</b> ©	6652DK	<b>K-Series</b>	SBC	10-1/2" x 6-3/16" x 2-1/4" (26.67 x 15.72 x 5.72 cm)	24/ctn
<b>1 Compartment</b>						
	<b>K801</b>	6672KB	<b>K-Series</b>	SBC	12-3/4" x 8-1/2" x 2-1/8" (32.39 x 21.59 x 5.40 cm)	12/ctn
<b>1 Compartment</b>						
	<b>K812</b>	6676KB	<b>K-Series</b>	SBC	12-3/4" x 8-1/2" x 2-1/8" (32.39 x 21.59 x 5.40 cm)	12/ctn
<b>12 Compartments (L x W): A= 2-1/16" x 4-3/16" (5.24 x 12.22 cm)</b>						

**K-SERIES**

**SIZE RANGE**

**12-3/4" x 8-1/2" x 2-1/8"** (32.39 x 21.59 x 5.40 cm) — **12-3/4" x 8-1/2" x 2-1/8"** (32.39 x 21.59 x 5.40 cm)

**BOX MATERIAL KEY**



**SYMBOL KEY**

**TP** = Translucent Polypropylene  
**YP** = Yellow Polypropylene  
**WP** = White Polypropylene

**TCP** = Transparent Cellulose Propionate  
**SBMM** = Styrene-Butadiene Methyl Methacrylate  
**SBC** = Styrene-Butadiene Copolymer

**SP** = Taupe Polypropylene  
**OP** = Orange Polypropylene

Special Order 

BOX DIAGRAM	MODEL #	STOCK #	SERIES FAMILY	BOX MATERIAL	DIMENSIONS (INSIDE: L x W x D)	PACKED
	<b>K824</b>	6680KB	<b>K-Series</b>	SBC	12-3/4" x 8-1/2" x 2-1/8" (32.39 x 21.59 x 5.40 cm)	12/ctn
<b>24 Compartments (L x W): A= 2-1/16" x 2-1/16" (5.24 x 5.24 cm)</b>						
	<b>K818</b>	6678KB	<b>K-Series</b>	SBC	12-3/4" x 8-1/2" x 2-1/8" (32.39 x 21.59 x 5.40 cm)	12/ctn
<b>18 Compartments (L x W): A= 2-1/16" x 2-1/16" (5.24 x 5.24 cm), B= 2-1/16" x 4-3/16" (5.24 x 12.22 cm)</b>						
	<b>K806</b>	6674KB	<b>K-Series</b>	SBC	12-3/4" x 8-1/2" x 2-1/8" (32.39 x 21.59 x 5.40 cm)	12/ctn
<b>6 Compartments (L x W): A= 2-1/16" x 8-1/2" (5.24 x 21.59 cm)</b>						

*\* Adding color to the resins effects the clarity of the finished product*

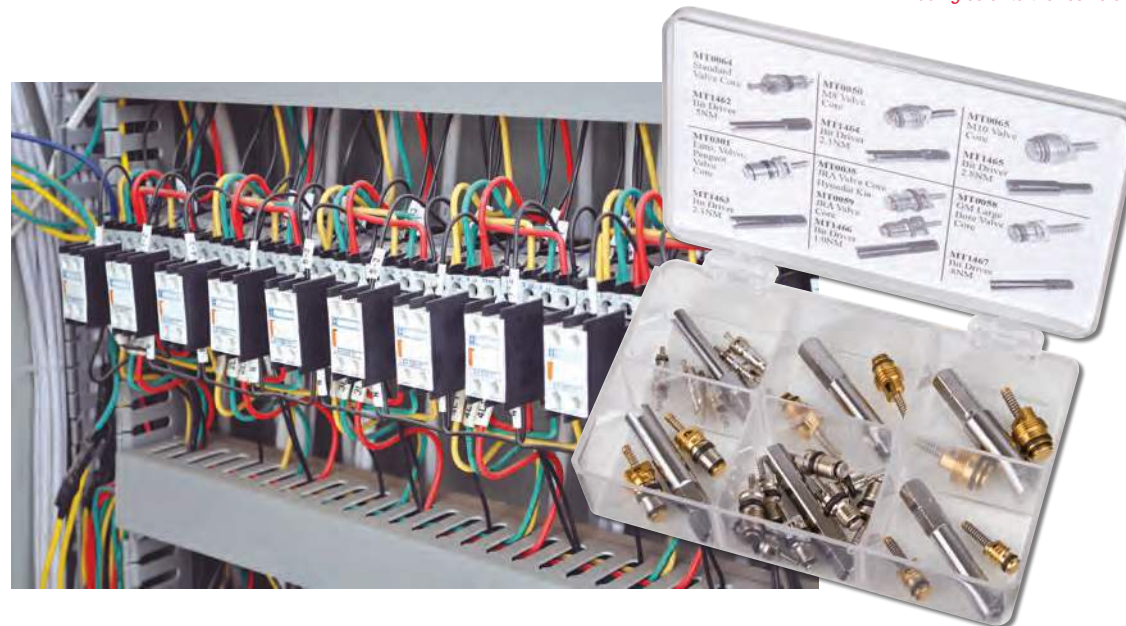

**K-SERIES**

# K-SERIES





## IDS™ -Series Boxes



## Polypropylene



- Clarity\*
- Impact Resistance
- Chemical Resistance

Our Infinite Divider System™ (IDS) box, made of polypropylene, features patented flexibility by allowing each divider to be moved 1/16" (0.16 cm) along the ribbed compartment. Select IDS boxes fit the IDS Cabinet shown on (page 75).

**SIZE RANGE** 6-5/8" x 3-3/8" x 1-5/16" (16.83 x 8.57 x 3.33 cm) — 13-1/8" x 8-7/8" x 1-15/16" (33.34 x 22.54 x 4.92 cm)

**BOX MATERIAL KEY**

**SYMBOL KEY**

**TP** = Translucent Polypropylene    **TCP** = Transparent Cellulose Propionate    **SP** = Taupe Polypropylene  
**YP** = Yellow Polypropylene    **SBMM** = Styrene-Butadiene Methyl Methacrylate    **OP** = Orange Polypropylene  
**WP** = White Polypropylene    **SBC** = Styrene-Butadiene Copolymer

Special Order 

BOX DIAGRAM	MODEL #	STOCK #	SERIES FAMILY	BOX MATERIAL	DIMENSIONS (INSIDE: L x W x D)	PACKED
	<b>T300</b>	6715ID	<b>IDS™-Series</b>	TP	6-5/8" x 3-3/8" x 1-5/16" (16.83 x 8.57 x 3.33 cm)	12/ctn
3 Compartments & 6 IDS Dividers (L x W): <b>A=</b> 6-5/8" x 1-1/16" (16.83 x 2.70 cm)						
	<b>T600</b>	6719ID	<b>IDS™-Series</b>	TP	10-1/2" x 6-3/16" x 1-9/16" (26.67 x 15.72 x 3.97 cm)	6/ctn
6 Compartments & 10 IDS Dividers (L x W): <b>A=</b> 1-11/16" x 6-3/16" (4.29 x 15.72 cm)						
	<b>999-2</b>	6726ID	<b>IDS™-Series</b>	TP	13-1/8" x 8-7/8" x 1-15/16" (33.34 x 22.54 x 4.92 cm)	6/ctn
4 Compartments with Handle & 16 IDS Dividers (L x W): <b>A=</b> 13-1/8" x 2-1/8" (33.34 x 5.40 cm)						
	<b>T900</b>	6725ID	<b>IDS™-Series</b>	TP	13-1/8" x 8-7/8" x 1-15/16" (33.34 x 22.54 x 4.92 cm)	6/ctn
4 Compartments & 16 IDS Dividers (L x W): <b>A=</b> 13-1/8" x 2-1/8" (33.34 x 5.40 cm)						

\* Adding color to the resins effects the clarity of the finished product

To Order Infinite Divider System™ Dividers:

MODEL #	PER PACK	ORDER #	BULK ORDER #
<b>T300</b>	8	<b>3108DP</b>	<b>601316</b>
<b>T600</b>	8	<b>6108DP</b>	<b>601308</b>
<b>999-2</b>	8	<b>9108DP</b>	<b>601310</b>
<b>T900</b>	8	<b>9108DP</b>	<b>601310</b>



US Patent 4,838,445

**Move dividers every 1/16"**  
(0.16 cm) - **no wasted space!**

## T-Series



## Polypropylene



- Clarity\*
- Impact Resistance
- Chemical Resistance

T-Series boxes provide the same durable construction as the popular M-Series, but are made with translucent polypropylene. These boxes are perfect for “visualizing” components within the box. The T-Series are impervious to most household chemicals, solvents, and gasoline. Great for storage and protection.









**SIZE RANGE** 4.0" x 3-3/8" x 13/16" (10.16 x 8.57 x 2.06 cm) — 8.0" x 4.0" x 1-3/16" (20.32 x 10.16 x 3.02 cm)

**BOX MATERIAL KEY**

**SYMBOL KEY**

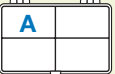
**TP** = Translucent Polypropylene    **TCP** = Transparent Cellulose Propionate    **SP** = Taupe Polypropylene  
**YP** = Yellow Polypropylene    **SBMM** = Styrene-Butadiene Methyl Methacrylate    **OP** = Orange Polypropylene  
**WP** = White Polypropylene    **SBC** = Styrene-Butadiene Copolymer

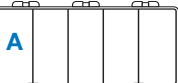
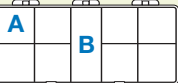
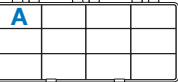
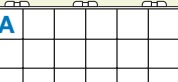
Special Order 

BOX DIAGRAM	MODEL #	STOCK #	SERIES FAMILY	BOX MATERIAL	DIMENSIONS (INSIDE: L x W x D)	PACKED
 1 Compartments	<b>2040-2</b> 	6242FA	<b>T-Series</b>	WP	4.0" x 3-3/8" x 13/16" (10.16 x 8.57 x 2.06 cm)	36/ctn
 4 Compartments (L x W): <b>A</b> = 2-3/16" x 1-5/16" (5.56 x 3.33 cm)	<b>T221</b>	6706TE	<b>T-Series</b>	TP	4-3/8" x 2-5/8" x 1.0" (11.11 x 6.67 x 2.54 cm)	36/ctn
 6 Compartments (L x W): <b>A</b> = 1-3/8" x 1-1/4" (3.49 x 3.18 cm)	<b>T220</b>	6704TE	<b>T-Series</b>	TP	4-3/8" x 2-5/8" x 1.0" (11.11 x 6.67 x 2.54 cm)	36/ctn
 5 Compartments (L x W): <b>A</b> = 1.0" x 2-7/8" (2.54 x 7.30 cm)	<b>T155</b>	6688TE	<b>T-Series</b>	TP	5-5/8" x 2-15/16" x 1-1/8" (14.29 x 7.46 x 2.86 cm)	36/ctn
 5 Compartments (L x W): <b>A</b> = 1-5/16" x 3-3/16" (3.33 x 8.10 cm)	<b>T215</b>	6702TE	<b>T-Series</b>	TP	6-3/4" x 3-3/16" x 1-3/16" (17.15 x 8.10 x 3.02 cm)	36/ctn
 9 Compartments (L x W): <b>A</b> = 1-5/16" x 1-9/16" (3.33 x 3.97 cm), <b>B</b> = 1-1/8" x 3-3/16" (2.86 x 8.10 cm)	<b>T210</b>	6698TE	<b>T-Series</b>	TP	6-3/4" x 3-3/16" x 1-3/16" (17.15 x 8.10 x 3.02 cm)	36/ctn
 12 Compartments (L x W): <b>A</b> = 1-7/16" x 1-1/16" (3.65 x 2.70 cm)	<b>T219</b>	6701TE	<b>T-Series</b>	TP	6-3/4" x 3-3/16" x 1-3/16" (17.15 x 8.10 x 3.02 cm)	36/ctn
 18 Compartments (L x W): <b>A</b> = 1-1/4" x 1-1/4" (3.18 x 3.18 cm)	<b>T200</b>	6690TE	<b>T-Series</b>	TP	8.0" x 4.0" x 1-3/16" (20.32 x 10.16 x 3.02 cm)	24/ctn
 12 Compartments (L x W): <b>A</b> = 1-5/16" x 1-5/16" (3.33 x 3.33 cm), <b>B</b> = 1-5/16" x 4.0" (3.33 x 10.16 cm), <b>C</b> = 1-5/16" x 2.0" (3.33 x 5.08 cm)	<b>T201</b>	6692TE	<b>T-Series</b>	TP	8.0" x 4.0" x 1-3/16" (20.32 x 10.16 x 3.02 cm)	24/ctn

**T-SERIES**

**SIZE RANGE**

**8.0" x 4.0" x 1-3/16"** (20.32 x 10.16 x 3.02 cm) — **13-1/8" x 8-7/8" x 1-15/16"** (33.34 x 22.54 x 4.92 cm)

**BOX MATERIAL KEY**

**SYMBOL KEY**

**TP** = Translucent Polypropylene  
**YP** = Yellow Polypropylene  
**WP** = White Polypropylene

**TCP** = Transparent Cellulose Propionate  
**SBMM** = Styrene-Butadiene Methyl Methacrylate  
**SBC** = Styrene-Butadiene Copolymer

**SP** = Taupe Polypropylene  
**OP** = Orange Polypropylene

Special Order 

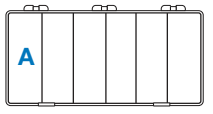
BOX DIAGRAM	MODEL #	STOCK #	SERIES FAMILY	BOX MATERIAL	DIMENSIONS (INSIDE: L x W x D)	PACKED
	<b>T203</b>	6694TE	<b>T-Series</b>	TP	8.0" x 4.0" x 1-3/16" (20.32 x 10.16 x 3.02 cm)	24/ctn
6 Compartments (L x W): <b>A=</b> 1-1/4" x 4.0" (3.18 x 10.16 cm)						
	<b>T616R</b>	6713TE	<b>T-Series</b>	TP	10-1/2" x 6-3/16" x 1-9/16" (26.67 x 15.72 x 3.97 cm)	24/ctn
4 Compartments & 12 Removable Dividers (L x W): <b>A=</b> 10-3/8" x 1-1/2" (26.35 x 3.81 cm)						
	<b>T623</b>	6715TE	<b>T-Series</b>	TP	10-1/2" x 6-3/16" x 1-9/16" (26.67 x 15.72 x 3.97 cm)	24/ctn
13 Compartments (L x W): <b>A=</b> 10-3/8" x 2-5/8" (26.35 x 6.67 cm), <b>B=</b> 1-11/16" x 1-5/16" (4.29 x 3.33 cm), <b>C=</b> 1-11/16" x 2.0" (4.29 x 5.08 cm)						
	<b>T612</b>	6712TE	<b>T-Series</b>	TP	10-1/2" x 6-3/16" x 1-9/16" (26.67 x 15.72 x 3.97 cm)	24/ctn
12 Compartments (L x W): <b>A=</b> 1-11/16" x 2.0" (4.29 x 5.08 cm), <b>B=</b> 1-11/16" x 4-1/8" (4.29 x 10.48 cm)						
	<b>T602</b>	6708TE	<b>T-Series</b>	TP	10-1/2" x 6-3/16" x 1-9/16" (26.67 x 15.72 x 3.97 cm)	24/ctn
12 Compartments (L x W): <b>A=</b> 1-11/16" x 3-1/16" (4.29 x 7.78 cm)						
	<b>T606</b>	6710TE	<b>T-Series</b>	TP	10-1/2" x 6-3/16" x 1-9/16" (26.67 x 15.72 x 3.97 cm)	24/ctn
6 Compartments (L x W): <b>A=</b> 1-11/16" x 6-1/4" (4.29 x 15.88 cm)						
	<b>T618</b>	6714TE	<b>T-Series</b>	TP	10-1/2" x 6-3/16" x 1-9/16" (26.67 x 15.72 x 3.97 cm)	24/ctn
18 Compartments (L x W): <b>A=</b> 1-3/4" x 2-1/16" (4.45 x 5.24 cm)						

BOX DIAGRAM	MODEL #	STOCK #	SERIES FAMILY	BOX MATERIAL	DIMENSIONS (INSIDE: L x W x D)	PACKED
	<b>T612D</b> ©	6713DB	<b>T-Series</b>	TP	10-1/2" x 6-3/16" x 2-1/4" (26.67 x 15.72 x 5.72 cm)	24/ctn
<b>12 Compartments (L x W):</b> <b>A=</b> 1-11/16" x 2.0" (4.29 x 5.08 cm), <b>B=</b> 1-11/16" x 4-1/8" (4.29 x 10.48 cm)						
	<b>T618D</b> ©	6715DB	<b>T-Series</b>	TP	10-1/2" x 6-3/16" x 2-1/4" (26.67 x 15.72 x 5.72 cm)	24/ctn
<b>18 Compartments (L x W):</b> <b>A=</b> 1-3/4" x 2-1/16" (4.45 x 5.24 cm)						
	<b>T606D</b>	6711DB	<b>T-Series</b>	TP	10-1/2" x 6-3/16" x 2-1/4" (26.67 x 15.72 x 5.72 cm)	24/ctn
<b>6 Compartments (L x W):</b> <b>A=</b> 1-11/16" x 6-1/4" (4.29 x 15.88 cm)						
	<b>T824</b>	6726TE	<b>T-Series</b>	TP	12-3/4" x 8-1/2" x 2-1/8" (32.39 x 21.59 x 5.40 cm)	12/ctn
<b>24 Compartments (L x W):</b> <b>A=</b> 2-1/16" x 2-1/16" (5.24 x 5.24 cm)						
	<b>T806</b>	6718TE	<b>T-Series</b>	TP	12-3/4" x 8-1/2" x 2-1/8" (32.39 x 21.59 x 5.40 cm)	12/ctn
<b>6 Compartments (L x W):</b> <b>A=</b> 2-1/16" x 8-1/2" (5.24 x 21.59 cm)						
	<b>T901</b> ©	6727ID	<b>T-Series</b>	TP	13-1/8" x 8-7/8" x 1-15/16" (33.34 x 22.54 x 4.92 cm)	6/ctn
<b>1 Compartment</b>						

# T-SERIES





## By Size Of Compartments: Large to Small



With the industry's largest selection of sizes and material types you can expect to find what you need right on our shelf. Yet, even with over 300 stock choices, sometimes we have a request for a unique size or compartment configuration. If so, please let us know. Most of our products can be altered to accommodate a special material or core

(compartment) requirement for your project. Finally, we will accommodate you by building a tool specifically for your project right with our Technologies Tool Group.

**To help you find what you need we have added a size reference chart that lists all of Flambeau's compartmented boxes from their smallest to largest dimension.**

BOX MATERIAL KEY			SYMBOL KEY
<b>TP</b> = Translucent Polypropylene	<b>TCP</b> = Transparent Cellulose Propionate	<b>SP</b> = Taupe Polypropylene	 = Special Order
<b>YP</b> = Yellow Polypropylene	<b>SBMM</b> = Styrene-Butadiene Methyl Methacrylate	<b>OP</b> = Orange Polypropylene	
<b>WP</b> = White Polypropylene	<b>SBC</b> = Styrene-Butadiene Copolymer		

DIMENSIONS (INSIDE: L x W x D)	MODEL #	FIXED COMPS	MATERIAL	PAGE
3-11/16" x 2-9/16" x 13/16" (9.37 x 6.51 x 2.06 cm)	<b>2020-2</b>	1	SBMM	<b>105</b>
4.0" x 3-2/5" x 1/2" (10.10 x 8.55 x 1.33 cm)	<b>A316-SL</b>	1	Styrene	<b>103</b>
4.0" x 3-2/5" x 1/2" (10.10 x 8.55 x 1.33 cm)	<b>A311-SL</b>	6	Styrene	<b>103</b>
4.0" x 3-2/5" x 1/2" (10.10 x 8.55 x 1.33 cm)	<b>A313-SL</b>	10	Styrene	<b>103</b>
4.0" x 3-3/8" x 13/16" (10.16 x 8.57 x 2.06 cm)	<b>2040-2</b> 	1	WP	<b>134</b>
4-1/4" Diameter x 3/4" (10.80 Diameter x 1.91 cm)	<b>A01</b> 	1	Styrene	<b>97</b>
4-5/16" x 2-5/8" x 1-1/16" (10.95 x 6.67 x 2.70 cm)	<b>5200CL</b>	1	TCP	<b>111</b>
4-5/16" x 2-5/8" x 1-1/16" (10.95 x 6.67 x 2.70 cm)	<b>5202CL</b>	2	TCP	<b>111</b>
4-5/16" x 2-5/8" x 1-1/16" (10.95 x 6.67 x 2.70 cm)	<b>5204CL</b>	4	TCP	<b>111</b>
4-5/16" x 2-5/8" x 1-1/16" (10.95 x 6.67 x 2.70 cm)	<b>5206CL</b> 	6	TCP	<b>111</b>
4-5/16" x 2-5/8" x 1-1/8" (10.95 x 6.67 x 2.86 cm)	<b>T1002</b>	4	TP	<b>119</b>
4-3/8" x 2-5/8" x 1.0" (11.11 x 6.67 x 2.54 cm)	<b>A226</b>	1	Styrene	<b>97</b>
	<b>K226</b>		SBC	<b>126</b>

DIMENSIONS (INSIDE: L x W x D)	MODEL #	FIXED COMPS	MATERIAL	PAGE
4-3/8" x 2-5/8" x 1.0" (11.11 x 6.67 x 2.54 cm)	<b>A228</b>	8	Styrene	<b>97</b>
4-3/8" x 2-5/8" x 1.0" (11.11 x 6.67 x 2.54 cm)	<b>A221</b>	4	Styrene	<b>97</b>
	<b>T221</b>		TP	<b>134</b>
	<b>M221</b> 		YP	<b>113</b>
4-3/8" x 2-5/8" x 1.0" (11.11 x 6.67 x 2.54 cm)	<b>A220</b>	6	Styrene	<b>97</b>
	<b>T220</b>		TP	<b>134</b>
	<b>K220</b>		SBC	<b>126</b>
	<b>M220</b> 		YP	<b>113</b>
4-1/2" X 2-11/16" x 1.0" (11.43 x 6.83 x 2.54 cm)	<b>DB221</b>	4	Styrene	<b>107</b>
4-1/2" X 2-11/16" x 1.0" (11.43 x 6.83 x 2.54 cm)	<b>DB228</b>	8	Styrene	<b>107</b>
4-1/2" X 2-11/16" x 1.0" (11.43 x 6.83 x 2.54 cm)	<b>DB220</b>	6	Styrene	<b>107</b>
4-1/2" X 2-11/16" x 1.0" (11.43 x 6.83 x 2.54 cm)	<b>DB226</b>	1	Styrene	<b>107</b>
5-1/8" X 3-9/16" x 1-1/2" (13.02 x 9.05 x 3.81 cm)	<b>A101</b>	1	Styrene	<b>97</b>
5-5/8" X 2-15/16" x 1-1/8" (14.29 x 7.46 x 2.86 cm)	<b>A154</b>	4	Styrene	<b>97</b>
5-5/8" X 2-15/16" x 1-1/8" (14.29 x 7.46 x 2.86 cm)	<b>A155</b>	5	Styrene	<b>97</b>
	<b>T155</b>		TP	<b>134</b>

## By Size Of Compartments: Large to Small

DIMENSIONS (INSIDE: L x W x D)	MODEL #	FIXED COMPS	MATERIAL	PAGE
5-5/8" X 3-5/8" x 1-1/8" (14.29 x 9.21 x 2.86 cm)	<b>3030-2</b>	1	SBMM	<b>105</b>
5-7/8" X 3-3/4" x 1-5/8" (14.92 x 9.53 x 4.13 cm)	<b>A250</b>	1	Styrene	<b>98</b>
6-5/8" X 3-3/8" x 1-5/16" (16.83 x 8.57 x 3.33 cm)	<b>T300</b>	3	TP	<b>132</b>
7-5/8" X 3-9/16" x 1.0" (19.38 x 9.05 x 2.54 cm)	<b>WT3000</b>	3	TP	<b>123</b>
6-11/16" X 3-5/16" x 1-5/16" (16.99 x 8.41 x 3.33 cm)	<b>T2003</b>	3	TP	<b>119</b>
6-3/4" X 3-3/16" x 1/2" (17.15 x 8.10 x 1.27 cm)	<b>A213-SL</b>	10	Styrene	<b>103</b>
6-3/4" X 3-3/16" x 1/2" (17.15 x 8.10 x 1.27 cm)	<b>A216-SL</b> ®	1	Styrene	<b>103</b>
6-3/4" X 3-3/16" x 1/2" (17.15 x 8.10 x 1.27 cm)	<b>A210-SL</b> ®	9	Styrene	<b>103</b>
6-3/4" X 3-3/16" x 1-3/16" (17.15 x 8.10 x 3.02 cm)	<b>A213</b>	10	Styrene	<b>98</b>
6-3/4" X 3-3/16" x 1-3/16" (17.15 x 8.10 x 3.02 cm)	<b>A214</b>	2	Styrene	<b>98</b>
6-3/4" X 3-3/16" x 1-3/16" (17.15 x 8.10 x 3.02 cm)	<b>A215</b>	5	Styrene	<b>98</b>
	<b>T215</b>		TP	<b>134</b>
	<b>K215</b>		SBC	<b>126</b>
	<b>M215</b> ®		YP	<b>113</b>
6-3/4" X 3-3/16" x 1-3/16" (17.15 x 8.10 x 3.02 cm)	<b>A210</b>	9	Styrene	<b>98</b>
	<b>T210</b>		TP	<b>134</b>
	<b>K210</b>		SBC	<b>126</b>
	<b>M210</b>		YP	<b>113</b>
6-3/4" X 3-3/16" x 1-3/16" (17.15 x 8.10 x 3.02 cm)	<b>A219</b>	12	Styrene	<b>98</b>
	<b>T219</b>		TP	<b>134</b>
	<b>K219</b>		SBC	<b>126</b>

DIMENSIONS (INSIDE: L x W x D)	MODEL #	FIXED COMPS	MATERIAL	PAGE
6-3/4" X 3-3/16" x 1-3/16" (17.15 x 8.10 x 3.02 cm)	<b>A217</b>	7	Styrene	<b>98</b>
6-3/4" X 3-3/16" x 1-3/16" (17.15 x 8.10 x 3.02 cm)	<b>A211</b>	6	Styrene	<b>98</b>
6-3/4" X 3-3/16" x 1-3/16" (17.15 x 8.10 x 3.02 cm)	<b>A216</b>	1	Styrene	<b>99</b>
	<b>K216</b>		SBC	<b>126</b>
6-3/4" X 3-3/16" x 1-3/16" (17.15 x 8.10 x 3.02 cm)	<b>A212</b>	5	Styrene	<b>99</b>
6-7/8" X 2-1/16" x 1.0" (17.46 x 5.24 x 2.54 cm)	<b>A701</b>	1	Styrene	<b>99</b>
	<b>K701</b>		SBC	<b>126</b>
7.0" X 3-1/4" x 1.0" (17.78 x 8.26 x 2.54 cm)	<b>V301</b>	1	OP	<b>117</b>
	<b>V301PT</b>		SP	<b>117</b>
7.0" X 3-3/8" x 1-1/8" (17.78 x 8.57 x 2.86 cm)	<b>DB216</b>	1	Styrene	<b>107</b>
7.0" X 3-3/8" x 1-1/8" (17.78 x 8.57 x 2.86 cm)	<b>DB211</b>	6	Styrene	<b>107</b>
7.0" X 3-3/8" x 1-1/8" (17.78 x 8.57 x 2.86 cm)	<b>DB219</b>	12	Styrene	<b>107</b>
7.0" X 3-3/8" x 1-1/8" (17.78 x 8.57 x 2.86 cm)	<b>DB210</b>	9	Styrene	<b>107</b>
7.0" X 3-3/8" x 1-1/8" (17.78 x 8.57 x 2.86 cm)	<b>DB213</b>	10	Styrene	<b>107</b>
7.0" X 3-3/8" x 1-1/8" (17.78 x 8.57 x 2.86 cm)	<b>DB217</b>	7	Styrene	<b>107</b>
7.0" X 4.0" x 1-1/16" (17.78 x 10.16 x 2.70 cm)	<b>5126CL</b>	17	TCP	<b>111</b>
7.0" X 4.0" x 1-1/16" (17.78 x 10.16 x 2.70 cm)	<b>5127CL</b>	11	TCP	<b>111</b>
7.0" X 4.0" x 1-1/16" (17.78 x 10.16 x 2.70 cm)	<b>5128CL</b>	6	TCP	<b>111</b>
7-1/8" X 5-1/8" x 1-9/16" (18.10 x 13.02 x 3.97 cm)	<b>A401</b>	1	Styrene	<b>99</b>

## By Size Of Compartments: Large to Small

BOX MATERIAL KEY			SYMBOL KEY
<b>TP</b> = Translucent Polypropylene	<b>TCP</b> = Transparent Cellulose Propionate	<b>SP</b> = Taupe Polypropylene	 = Special Order
<b>YP</b> = Yellow Polypropylene	<b>SBMM</b> = Styrene-Butadiene Methyl Methacrylate	<b>OP</b> = Orange Polypropylene	
<b>WP</b> = White Polypropylene	<b>SBC</b> = Styrene-Butadiene Copolymer		

DIMENSIONS (INSIDE: L x W x D)	MODEL #	FIXED COMPS	MATERIAL	PAGE
8.0" X 4.0" x 1-3/16" (20.32 x 10.16 x 3.02 cm)	<b>A204</b>	12	Styrene	<b>99</b>
8.0" X 4.0" x 1-3/16" (20.32 x 10.16 x 3.02 cm)	<b>A206</b> <b>K206</b>	1	Styrene SBC	<b>99</b> <b>126</b>
8.0" X 4.0" x 1-3/16" (20.32 x 10.16 x 3.02 cm)	<b>A209</b>	9	Styrene	<b>99</b>
8.0" X 4.0" x 1-3/16" (20.32 x 10.16 x 3.02 cm)	<b>A200</b> <b>T200</b> <b>K200</b> <b>M200</b> ®	18	Styrene TP SBC YP	<b>99</b> <b>134</b> <b>126</b> <b>113</b>
8.0" X 4.0" x 1-3/16" (20.32 x 10.16 x 3.02 cm)	<b>A208</b> <b>K208</b> <b>M208</b>	12	Styrene SBC YP	<b>99</b> <b>127</b> <b>113</b>
8.0" X 4.0" x 1-3/16" (20.32 x 10.16 x 3.02 cm)	<b>A201</b> <b>T201</b> <b>K201</b> <b>M201</b>	12	Styrene TP SBC YP	<b>100</b> <b>134</b> <b>127</b> <b>113</b>
8.0" X 4.0" x 1-3/16" (20.32 x 10.16 x 3.02 cm)	<b>A203</b> <b>T203</b> <b>K203</b> <b>M203</b>	6	Styrene TP SBC YP	<b>100</b> <b>135</b> <b>127</b> <b>113</b>
8-1/8" X 4-1/8" x 1-3/16" (20.64 x 10.48 x 3.02 cm)	<b>V401</b>	1	SP	<b>117</b>
8-1/8" X 4-1/8" x 1-3/16" (20.64 x 10.48 x 3.02 cm)	<b>V402-2</b> ®	2	SP	<b>117</b>
8-1/8" X 4-1/8" x 2-5/8" (20.64 x 10.48 x 6.67 cm)	<b>V401D-2</b>	1	SP	<b>117</b>
8-7/16" X 4-1/4" x 1-3/16" (21.43 x 10.80 x 3.02 cm)	<b>DB201</b>	12	Styrene	<b>108</b>

DIMENSIONS (INSIDE: L x W x D)	MODEL #	FIXED COMPS	MATERIAL	PAGE
8-7/16" X 4-1/4" x 1-3/16" (21.43 x 10.80 x 3.02 cm)	<b>DB203</b>	6	Styrene	<b>108</b>
8-7/16" X 4-1/4" x 1-3/16" (21.43 x 10.80 x 3.02 cm)	<b>DB208</b>	12	Styrene	<b>108</b>
8-7/16" X 4-1/4" x 1-3/16" (21.43 x 10.80 x 3.02 cm)	<b>DB200</b>	18	Styrene	<b>108</b>
8-7/16" X 4-1/4" x 1-3/16" (21.43 x 10.80 x 3.02 cm)	<b>DB206</b> ®	1	Styrene	<b>108</b>
8-7/16" X 4-1/4" x 1-3/16" (21.43 x 10.80 x 3.02 cm)	<b>DB204</b>	12	Styrene	<b>108</b>
8-3/4" X 4-5/16" x 1-1/4" (22.23 x 10.95 x 3.18 cm)	<b>4040-2</b>	1	SBMM	<b>105</b>
9.0" X 4.0" x 1-1/4" (22.86 x 10.16 x 3.18 cm)	<b>T3003</b>	3	TP	<b>119</b>
9-5/16" X 5-13/16" x 1-1/4" (23.65 x 14.77 x 3.18 cm)	<b>WT4000</b>	1	TP	<b>123</b>
9-5/8" X 6-9/16" x 1-1/2" (24.45 x 16.69 x 3.81 cm)	<b>A166-36</b> <b>K166-36</b>	36	Styrene SBC	<b>100</b> <b>127</b>
10.0" X 4-1/4" x 1-1/2" (25.40 x 10.80 x 3.81 cm)	<b>V501</b>	1	SP	<b>117</b>
10.0" X 4-1/4" x 1-1/2" (25.40 x 10.80 x 3.81 cm)	<b>V506-2</b> ®	6	SP	<b>117</b>
10-1/2" X 6-3/16" x 1-9/16" (26.67 x 15.72 x 3.97 cm)	<b>T616R</b> <b>K616R</b> ® <b>M616R</b> ®	4	TP SBC YP	<b>135</b> <b>127</b> <b>115</b>



## By Size Of Compartments: Large to Small

DIMENSIONS (INSIDE: L x W x D)	MODEL #	FIXED COMPS	MATERIAL	PAGE
10-1/2" X 6-3/16" x 1-9/16" (26.67 x 15.72 x 3.97 cm)	<b>A623</b> ®	13	Styrene	<b>90</b>
	<b>T623</b>		TP	<b>135</b>
	<b>K623</b> ®		SBC	<b>127</b>
	<b>M623</b>		YP	<b>114</b>
10-1/2" X 6-3/16" x 1-9/16" (26.67 x 15.72 x 3.97 cm)	<b>A612</b> ®	12	Styrene	<b>100</b>
	<b>T612</b>		TP	<b>135</b>
	<b>M612</b>		YP	<b>114</b>
10-1/2" X 6-3/16" x 1-9/16" (26.67 x 15.72 x 3.97 cm)	<b>A602</b>	12	Styrene	<b>100</b>
	<b>T602</b>		TP	<b>135</b>
	<b>K602</b>		SBC	<b>127</b>
	<b>M602</b>		YP	<b>114</b>
10-1/2" X 6-3/16" x 1-9/16" (26.67 x 15.72 x 3.97 cm)	<b>A606</b>	6	Styrene	<b>100</b>
	<b>T606</b>		TP	<b>135</b>
	<b>K606</b>		SBC	<b>127</b>
	<b>M606</b>		YP	<b>114</b>
10-1/2" X 6-3/16" x 1-9/16" (26.67 x 15.72 x 3.97 cm)	<b>A613</b>	13	Styrene	<b>100</b>
10-1/2" X 6-3/16" x 1-9/16" (26.67 x 15.72 x 3.97 cm)	<b>A607</b> ®	7	Styrene	<b>101</b>
	<b>K607</b> ®		SBC	<b>128</b>
10-1/2" X 6-3/16" x 1-9/16" (26.67 x 15.72 x 3.97 cm)	<b>T600</b>	6	TP	<b>132</b>
10-1/2" X 6-3/16" x 1-9/16" (26.67 x 15.72 x 3.97 cm)	<b>A601</b>	1	Styrene	<b>101</b>
	<b>K601</b>		SBC	<b>128</b>
10-1/2" X 6-3/16" x 1-9/16" (26.67 x 15.72 x 3.97 cm)	<b>A618</b>	18	Styrene	<b>101</b>
	<b>T618</b>		TP	<b>135</b>
	<b>K618</b>		SBC	<b>128</b>
	<b>M618</b>		YP	<b>114</b>
10-1/2" X 6-3/16" x 1-9/16" (26.67 x 15.72 x 3.97 cm)	<b>A603</b> ®	3	Styrene	<b>101</b>
10-1/2" X 6-3/16" x 2-1/4" (26.67 x 15.72 x 5.72 cm)	<b>A612D</b> ®	12	Styrene	<b>101</b>
	<b>T612D</b> ®		TP	<b>136</b>
	<b>K612D</b> ®		SBC	<b>128</b>
	<b>M612D</b> ®		YP	<b>114</b>

DIMENSIONS (INSIDE: L x W x D)	MODEL #	FIXED COMPS	MATERIAL	PAGE
10-1/2" X 6-3/16" x 2-1/4" (26.67 x 15.72 x 5.72 cm)	<b>A618D</b> ®	18	Styrene	<b>101</b>
	<b>T618D</b> ®		TP	<b>136</b>
	<b>K618D</b> ®		SBC	<b>128</b>
	<b>M618D</b> ®		YP	<b>114</b>
10-1/2" X 6-3/16" x 2-1/4" (26.67 x 15.72 x 5.72 cm)	<b>A601D</b> ®	1	Styrene	<b>101</b>
	<b>K601D</b> ®		SBC	<b>128</b>
10-1/2" X 6-3/16" x 2-1/4" (26.67 x 15.72 x 5.72 cm)	<b>A606D</b> ®	6	Styrene	<b>101</b>
	<b>T606D</b>		TP	<b>136</b>
	<b>K606D</b> ®		SBC	<b>128</b>
	<b>M606D</b> ®		YP	<b>115</b>
10-1/2" X 6-1/4" x 1-1/2" (26.67 x 15.88 x 3.81 cm)	<b>T4004</b>	5	TP	<b>119</b>
10-1/2" X 6-1/4" x 1-1/2" (26.67 x 15.88 x 3.81 cm)	<b>T4007</b>	4	TP	<b>119</b>
10-1/2" X 6-1/4" x 1-1/2" (26.67 x 15.88 x 3.81 cm)	<b>T4007AT</b>	4	TP	<b>119</b>
10-1/2" X 6-1/4" x 1-1/2" (26.67 x 15.88 x 3.81 cm)	<b>T4000</b>	1	TP	<b>120</b>
10-1/2" X 6-1/4" x 1-1/2" (26.67 x 15.88 x 3.81 cm)	<b>T4008</b>	4	TP	<b>119</b>
10-9/16" X 8-1/4" x 1-9/16" (26.83 x 20.96 x 3.97 cm)	<b>A924-2</b>	24	Styrene	<b>101</b>
11.0" X 6-3/8" x 1-9/16" (27.94 x 16.19 x 3.97 cm)	<b>DB606</b>	6	Styrene	<b>108</b>
11.0" X 6-3/8" x 1-9/16" (27.94 x 16.19 x 3.97 cm)	<b>DB613</b>	13	Styrene	<b>109</b>
11.0" X 6-3/8" x 1-9/16" (27.94 x 16.19 x 3.97 cm)	<b>DB601</b> ®	1	Styrene	<b>109</b>
11.0" X 6-3/8" x 1-9/16" (27.94 x 16.19 x 3.97 cm)	<b>DB618</b>	18	Styrene	<b>109</b>

## By Size Of Compartments: Large to Small

BOX MATERIAL KEY			SYMBOL KEY
<b>TP</b> = Translucent Polypropylene	<b>TCP</b> = Transparent Cellulose Propionate	<b>SP</b> = Taupe Polypropylene	 = Special Order
<b>YP</b> = Yellow Polypropylene	<b>SBMM</b> = Styrene-Butadiene Methyl Methacrylate	<b>OP</b> = Orange Polypropylene	
<b>WP</b> = White Polypropylene	<b>SBC</b> = Styrene-Butadiene Copolymer		

DIMENSIONS (INSIDE: L x W x D)	MODEL #	FIXED COMPS	MATERIAL	PAGE
11-15/16" X 5-15/16" x 1-7/16" (30.32 x 15.08 x 3.65 cm)	<b>5129-1</b>	1	TCP	<b>111</b>
11-15/16" X 5-15/16" x 1-7/16" (30.32 x 15.08 x 3.65 cm)	<b>5129CL</b>	24	TCP	<b>111</b>
11-15/16" X 5-15/16" x 1-7/16" (30.32 x 15.08 x 3.65 cm)	<b>5130CL</b>	6	TCP	<b>111</b>
12.0" x 4.0" x 1-1/16" (30.48 x 10.16 x 2.70 cm)	<b>T3011</b>	1	TP	<b>120</b>
12-1/2" X 7-1/2" x 1-7/16" (31.75 x 19.05 x 3.65 cm)	<b>WT5000</b>	1	TP	<b>123</b>
12-1/2" X 7-1/2" x 2-5/16" (31.75 x 19.05 x 5.88 cm)	<b>WT5001</b>	1	TP	<b>123</b>
12-3/4" X 8-1/2" x 2-1/8" (32.39 x 21.59 x 5.40 cm)	<b>M808</b> ®	8	YP	<b>115</b>
12-3/4" X 8-1/2" x 2-1/8" (32.39 x 21.59 x 5.40 cm)	<b>A801</b>	1	Styrene	<b>102</b>
	<b>K801</b>		SBC	<b>128</b>
12-3/4" X 8-1/2" x 2-1/8" (32.39 x 21.59 x 5.40 cm)	<b>A812</b>	12	Styrene	<b>2</b>
	<b>K812</b>		SBC	<b>127</b>
	<b>M812</b>		YP	<b>115</b>
12-3/4" X 8-1/2" x 2-1/8" (32.39 x 21.59 x 5.40 cm)	<b>A824</b>	24	Styrene	<b>102</b>
	<b>T824</b>		TP	<b>136</b>
	<b>K824</b>		SBC	<b>129</b>
	<b>M824</b>		YP	<b>115</b>
12-3/4" X 8-1/2" x 2-1/8" (32.39 x 21.59 x 5.40 cm)	<b>A818</b> ®	18	Styrene	<b>102</b>
	<b>K818</b>		SBC	<b>129</b>
	<b>M818</b>		YP	<b>115</b>
12-3/4" X 8-1/2" x 2-1/8" (32.39 x 21.59 x 5.40 cm)	<b>A806</b> ®	6	Styrene	<b>102</b>
	<b>T806</b>		TP	<b>136</b>
	<b>K806</b>		SBC	<b>129</b>
	<b>M806</b>		YP	<b>115</b>

DIMENSIONS (INSIDE: L x W x D)	MODEL #	FIXED COMPS	MATERIAL	PAGE
13-1/8" X 8-7/8" x 1-15/16" (33.34 x 22.54 x 4.92 cm)	<b>T901</b> ®	1	TP	<b>136</b>
13-1/8" X 8-7/8" x 1-15/16" (33.34 x 22.54 x 4.92 cm)	<b>999-2</b>	4	TP	<b>132</b>
13-1/8" X 8-7/8" x 1-15/16" (33.34 x 22.54 x 4.92 cm)	<b>T900</b>	4	TP	<b>132</b>
13-1/2" X 5-3/4" x 2.0" (34.29 x 14.61 x 5.08 cm)	<b>V601</b>	1	SP	<b>117</b>
13-11/16" X 8-3/16" x 1-3/4" (34.77 x 20.80 x 4.45 cm)	<b>T5003</b>	3	TP	<b>120</b>
13-11/16" X 8-3/16" x 1-3/4" (34.77 x 20.80 x 4.45 cm)	<b>T5007</b>	4	TP	<b>120</b>
13-11/16" X 8-3/16" x 1-3/4" (34.77 x 20.80 x 4.45 cm)	<b>T5008</b>	4	TP	<b>120</b>
13-11/16" X 8-3/16" x 1-3/4" (34.77 x 20.80 x 4.45 cm)	<b>T5007AT</b>	4	TP	<b>120</b>
15-1/4" X 8-7/8" x 1-3/8" (38.74 x 22.54 x 3.49 cm)	<b>T6004</b>	6	TP	<b>121</b>
15-1/4" X 8-7/8" x 3.0" (38.74 x 22.54 x 7.62 cm)	<b>T7003</b>	6	TP	<b>121</b>
15-1/4" X 8-7/8" x 3.0" (38.74 x 22.54 x 7.62 cm)	<b>T7004</b>	7	TP	<b>121</b>
15-1/4" X 8-7/8" x 3.0" (38.74 x 22.54 x 7.62 cm)	<b>T7000</b>	1	TP	<b>121</b>
17.0" X 7-1/8" x 2.0" (43.18 x 18.10 x 5.08 cm)	<b>V701</b>	1	SP	<b>117</b>

## By Number Of Compartments: 1 to 36



FIXED COMPS	MODEL #	DIMENSIONS (INSIDE: L x W x D)	MATERIAL	PAGE
1	<b>2020-2</b>	3-11/16" x 2-9/16" x 13/16" (9.37 x 6.51 x 2.06 cm)	SBMM	<b>105</b>
1	<b>A316-SL</b>	4.0" x 3-2/5" x 1/2" (10.10 x 8.55 x 1.33 cm)	Styrene	<b>103</b>
1	<b>2040-2</b> ®	4.0" x 3-3/8" x 13/16" (10.16 x 8.57 x 2.06 cm)	WP	<b>134</b>
1	<b>A01</b> ®	4-1/4" Diameter x 3/4" (10.80 Diameter x 1.91 cm)	Styrene	<b>97</b>
1	<b>5200CL</b>	4-5/16" x 2-5/8" x 1-1/16" (10.95 x 6.67 x 2.70 cm)	TCP	<b>111</b>
1	<b>A226</b> <b>K226</b>	4-3/8" x 2-5/8" x 1.0" (11.11 x 6.67 x 2.54 cm)	Styrene SBC	<b>97</b> <b>126</b>
1	<b>DB226</b>	4-1/2" X 2-11/16" x 1.0" (11.43 x 6.83 x 2.54 cm)	Styrene	<b>107</b>
1	<b>A101</b>	5-1/8" X 3-9/16" x 1-1/2" (13.02 x 9.05 x 3.81 cm)	Styrene	<b>97</b>
1	<b>3030-2</b>	5-5/8" X 3-5/8" x 1-1/8" (14.29 x 9.21 x 2.86 cm)	SBMM	<b>105</b>
1	<b>A250</b>	5-7/8" X 3-3/4" x 1-5/8" (14.92 x 9.53 x 4.13 cm)	Styrene	<b>98</b>
1	<b>WT3000</b>	7-5/8" x 3-9/16" x 1.0" (19.38 x 9.05 x 2.54 cm)	TP	<b>123</b>
1	<b>A216-SL</b> ®	6-3/4" X 3-3/16" x 1/2" (17.15 x 8.10 x 1.27 cm)	Styrene	<b>103</b>
1	<b>A216</b> <b>K216</b>	6-3/4" X 3-3/16" x 1-3/16" (17.15 x 8.10 x 3.02 cm)	Styrene SBC	<b>99</b> <b>126</b>
1	<b>A701</b> <b>K701</b>	6-7/8" X 2-1/16" x 1.0" (17.46 x 5.24 x 2.54 cm)	Styrene SBC	<b>99</b> <b>126</b>
1	<b>V301</b> <b>V301PT</b>	7.0" X 3-1/4" x 1.0" (17.78 x 8.26 x 2.54 cm)	OP SP	<b>117</b> <b>117</b>
1	<b>DB216</b>	7.0" X 3-3/8" x 1-1/8" (17.78 x 8.57 x 2.86 cm)	Styrene	<b>107</b>



FIXED COMPS	MODEL #	DIMENSIONS (INSIDE: L x W x D)	MATERIAL	PAGE
1	<b>A401</b>	7-1/8" X 5-1/8" x 1-9/16" (18.10 x 13.02 x 3.97 cm)	Styrene	<b>99</b>
1	<b>A206</b> <b>K206</b>	8.0" X 4.0" x 1-3/16" (20.32 x 10.16 x 3.02 cm)	Styrene SBC	<b>99</b> <b>126</b>
1	<b>V401</b>	8-1/8" X 4-1/8" x 1-3/16" (20.64 x 10.48 x 3.02 cm)	SP	<b>117</b>
1	<b>V401D-2</b>	8-1/8" X 4-1/8" x 2-5/8" (20.64 x 10.48 x 6.67 cm)	SP	<b>117</b>
1	<b>DB206</b> ®	8-7/16" X 4-1/4" x 1-3/16" (21.43 x 10.80 x 3.02 cm)	Styrene	<b>108</b>
1	<b>4040-2</b>	8-3/4" X 4-5/16" x 7/8" (22.23 x 10.95 x 2.22 cm)	SBMM	<b>105</b>
1	<b>WT4000</b>	9-5/16" x 5-13/16" x 1-1/4" (23.65 x 14.77 x 3.18 cm)	TP	<b>123</b>
1	<b>V501</b>	10.0" X 4-1/4" x 1-1/2" (25.40 x 10.80 x 3.81 cm)	SP	<b>117</b>
1	<b>A601</b> <b>K601</b>	10-1/2" X 6-3/16" x 1-9/16" (26.67 x 15.72 x 3.97 cm)	Styrene SBC	<b>101</b> <b>128</b>
1	<b>A601D</b> ® <b>K601D</b> ®	10-1/2" X 6-3/16" x 2-1/4" (26.67 x 15.72 x 5.72 cm)	Styrene SBC	<b>101</b> <b>128</b>
1	<b>T4000</b>	10-1/2" X 6-1/4" x 1-1/2" (26.67 x 15.88 x 3.81 cm)	TP	<b>120</b>
1	<b>DB601</b> ®	11.0" X 6-3/8" x 1-9/16" (27.94 x 16.19 x 3.97 cm)	Styrene	<b>109</b>
1	<b>5129-1</b>	11-15/16" X 5-15/16" x 1-7/16" (30.32 x 15.08 x 3.65 cm)	TCP	<b>111</b>
1	<b>T3011</b>	12.0" x 4.0" x 1-1/16" (30.48 x 10.16 x 2.70 cm)	TP	<b>120</b>
1	<b>WT5000</b>	12-1/2" x 7-1/2" x 1-7/16" (31.75 x 19.05 x 3.65 cm)	TP	<b>123</b>
1	<b>WT5001</b>	12-1/2" x 7-1/2" x 2-5/16" (31.75 x 19.05 x 5.88 cm)	TP	<b>123</b>



## By Number Of Compartments: 1 to 36

BOX MATERIAL KEY				SYMBOL KEY	
<b>TP</b> = Translucent Polypropylene	<b>TCP</b> = Transparent Cellulose Propionate	<b>SP</b> = Taupe Polypropylene		 = Special Order	
<b>YP</b> = Yellow Polypropylene	<b>SBMM</b> = Styrene-Butadiene Methyl Methacrylate	<b>OP</b> = Orange Polypropylene			
<b>WP</b> = White Polypropylene	<b>SBC</b> = Styrene-Butadiene Copolymer				

FIXED COMPS	MODEL #	DIMENSIONS (INSIDE: L x W x D)	MATERIAL	PAGE
1	<b>A801</b>	12-3/4" X 8-1/2" x 2-1/8"	Styrene	<b>102</b>
	<b>K801</b>	(32.39 x 21.59 x 5.40 cm)	SBC	<b>128</b>
1	<b>T901</b> 	13-1/8" X 8-7/8" x 1-15/16" (33.34 x 22.54 x 4.92 cm)	TP	<b>136</b>
1	<b>V601</b>	13-1/2" X 5-3/4" x 2.0" (34.29 x 14.61 x 5.08 cm)	SP	<b>117</b>
1	<b>T7000</b>	15-1/4" X 8-7/8" x 3.0" (38.74 x 22.54 x 7.62 cm)	TP	<b>121</b>
1	<b>V701</b>	17.0" X 7-1/8" x 2.0" (43.18 x 18.10 x 5.08 cm)	SP	<b>117</b>
2	<b>5202CL</b>	4-5/16" x 2-5/8" x 1-1/16" (10.95 x 6.67 x 2.70 cm)	TCP	<b>111</b>
2	<b>A214</b>	6-3/4" X 3-3/16" x 1-3/16" (17.15 x 8.10 x 3.02 cm)	Styrene	<b>98</b>
2	<b>V402-2</b> 	8-1/8" X 4-1/8" x 1-3/16" (20.64 x 10.48 x 3.02 cm)	SP	<b>117</b>
3	<b>T300</b>	6-5/8" X 3-3/8" x 1-5/16" (16.83 x 8.57 x 3.33 cm)	TP	<b>132</b>
3	<b>T2003</b>	6-11/16" X 3-5/16" x 1-5/16" (16.99 x 8.41 x 3.33 cm)	TP	<b>119</b>
3	<b>T3003</b>	9.0" X 4.0" x 1-1/4" (22.86 x 10.16 x 3.18 cm)	TP	<b>119</b>
3	<b>A603</b> 	10-1/2" X 6-3/16" x 1-9/16" (26.67 x 15.72 x 3.97 cm)	Styrene	<b>111</b>
3	<b>T5003</b>	13-11/16" X 8-3/16" x 1-3/4" (34.77 x 20.80 x 4.45 cm)	TP	<b>120</b>
4	<b>5204CL</b>	4-5/16" x 2-5/8" x 1-1/16" (10.95 x 6.67 x 2.70 cm)	TCP	<b>111</b>

FIXED COMPS	MODEL #	DIMENSIONS (INSIDE: L x W x D)	MATERIAL	PAGE
4	<b>T1002</b>	4-5/16" x 2-5/8" x 1-1/8" (10.95 x 6.67 x 2.86 cm)	TP	<b>119</b>
4	<b>A221</b>	4-3/8" x 2-5/8" x 1.0"	Styrene	<b>97</b>
	<b>T221</b>	(11.11 x 6.67 x 2.54 cm)	TP	<b>134</b>
	<b>M221</b> 		YP	<b>113</b>
4	<b>DB221</b>	4-1/2" X 2-11/16" x 1.0" (11.43 x 6.83 x 2.54 cm)	Styrene	<b>107</b>
4	<b>A154</b>	5-5/8" X 2-15/16" x 1-1/8" (14.29 x 7.46 x 2.86 cm)	Styrene	<b>97</b>
4	<b>T616R</b>	10-1/2" X 6-3/16" x 1-9/16"	TP	<b>135</b>
	<b>K616R</b> 	(26.67 x 15.72 x 3.97 cm)	SBC	<b>127</b>
	<b>M616R</b> 		YP	<b>114</b>
4	<b>T4007</b>	10-1/2" X 6-1/4" x 1-1/2" (26.67 x 15.88 x 3.81 cm)	TP	<b>119</b>
4	<b>T4007AT</b>	10-1/2" X 6-1/4" x 1-1/2" (26.67 x 15.88 x 3.81 cm)	TP	<b>119</b>
4	<b>T4008</b>	10-1/2" X 6-1/4" x 1-1/2" (26.67 x 15.88 x 3.81 cm)	TP	<b>120</b>
4	<b>999-2</b>	13-1/8" X 8-7/8" x 1-15/16" (33.34 x 22.54 x 4.92 cm)	TP	<b>132</b>
4	<b>T900</b>	13-1/8" X 8-7/8" x 1-15/16" (33.34 x 22.54 x 4.92 cm)	TP	<b>132</b>
4	<b>T5007</b>	13-11/16" X 8-3/16" x 1-3/4" (34.77 x 20.80 x 4.45 cm)	TP	<b>120</b>
4	<b>T5008</b>	13-11/16" X 8-3/16" x 1-3/4" (34.77 x 20.80 x 4.45 cm)	TP	<b>120</b>

## By Number Of Compartments: 1 to 36

FIXED COMPS	MODEL #	DIMENSIONS (INSIDE: L x W x D)	MATERIAL	PAGE
4	<b>T5007AT</b>	13-11/16" X 8-3/16" x 1-3/4" (34.77 x 20.80 x 4.45 cm)	TP	<b>120</b>
5	<b>A155</b>	5-5/8" X 2-15/16" x 1-1/8"	Styrene	<b>97</b>
	<b>T155</b>	(14.29 x 7.46 x 2.86 cm)	TP	<b>134</b>
5	<b>A212</b>	6-3/4" X 3-3/16" x 1-3/16" (17.15 x 8.10 x 3.02 cm)	Styrene	<b>99</b>
5	<b>A215</b>	6-3/4" X 3-3/16" x 1-3/16"	Styrene	<b>98</b>
	<b>T215</b>	(17.15 x 8.10 x 3.02 cm)	TP	<b>134</b>
	<b>K215</b>		SBC	<b>126</b>
	<b>M215</b> ®		YP	<b>113</b>
5	<b>T4004</b>	10-1/2" X 6-1/4" x 1-1/26" (26.67 x 15.88 x 3.81 cm)	TP	<b>119</b>
6	<b>A311-SL</b>	4.0" x 3-2/5" x 1/2" (10.10 x 8.55 x 1.33 cm)	Styrene	<b>103</b>
6	<b>5206CL</b> ®	4-5/16" x 2-5/8" x 1-1/16" (10.95 x 6.67 x 2.70 cm)	TCP	<b>111</b>
6	<b>A220</b>	4-3/8" x 2-5/8" x 1.0"	Styrene	<b>97</b>
	<b>T220</b>	(11.11 x 6.67 x 2.54 cm)	TP	<b>134</b>
	<b>K220</b>		SBC	<b>126</b>
	<b>M220</b> ®		YP	<b>113</b>
6	<b>DB220</b>	4-1/2" X 2-11/16" x 1.0" (11.43 x 6.83 x 2.54 cm)	Styrene	<b>107</b>
6	<b>A211</b>	6-3/4" X 3-3/16" x 1-3/16" (17.15 x 8.10 x 3.02 cm)	Styrene	<b>98</b>
6	<b>DB211</b>	7.0" X 3-3/8" x 1-1/8" (17.78 x 8.57 x 2.86 cm)	Styrene	<b>107</b>
6	<b>5128CL</b>	7.0" X 4.0" x 1-1/16" (17.78 x 10.16 x 2.70 cm)	TCP	<b>111</b>
6	<b>A203</b>	8.0" X 4.0" x 1-3/16"	Styrene	<b>100</b>
	<b>T203</b>	(20.32 x 10.16 x 3.02 cm)	TP	<b>135</b>
	<b>K203</b>		SBC	<b>127</b>
	<b>M203</b>		YP	<b>113</b>

FIXED COMPS	MODEL #	DIMENSIONS (INSIDE: L x W x D)	MATERIAL	PAGE
6	<b>DB203</b>	8-7/16" X 4-1/4" x 1-3/16" (21.43 x 10.80 x 3.02 cm)	Styrene	<b>108</b>
6	<b>V506-2</b> ®	10.0" X 4-1/4" x 1-1/2" (25.40 x 10.80 x 3.81 cm)	SP	<b>117</b>
6	<b>A606</b>	10-1/2" X 6-3/16" x 1-9/16"	Styrene	<b>100</b>
	<b>T606</b>	(26.67 x 15.72 x 3.97 cm)	TP	<b>135</b>
	<b>K606</b>		SBC	<b>127</b>
	<b>M606</b>		YP	<b>114</b>
6	<b>T600</b>	10-1/2" X 6-3/16" x 1-9/16" (26.67 x 15.72 x 3.97 cm)	TP	<b>132</b>
6	<b>A606D</b> ®	10-1/2" X 6-3/16" x 2-1/4"	Styrene	<b>101</b>
	<b>T606D</b>	(26.67 x 15.72 x 5.72 cm)	TP	<b>136</b>
	<b>K606D</b> ®		SBC	<b>128</b>
	<b>M606D</b> ®		YP	<b>115</b>
6	<b>DB606</b>	11.0" X 6-3/8" x 1-9/16" (27.94 x 16.19 x 3.97 cm)	Styrene	<b>108</b>
6	<b>5130CL</b>	11-15/16" X 5-15/16" x 1-7/16" (30.32 x 15.08 x 3.65 cm)	TCP	<b>111</b>
6	<b>A806</b> ®	12-3/4" X 8-1/2" x 2-1/8"	Styrene	<b>102</b>
	<b>T806</b>	(32.39 x 21.59 x 5.40 cm)	TP	<b>136</b>
	<b>K806</b>		SBC	<b>129</b>
	<b>M806</b>		YP	<b>115</b>
6	<b>T6004</b>	15-1/4" X 8-7/8" x 1-3/8" (38.74 x 22.54 x 3.49 cm)	TP	<b>121</b>
6	<b>T7003</b>	15-1/4" X 8-7/8" x 3.0" (38.74 x 22.54 x 7.62 cm)	TP	<b>121</b>
7	<b>A217</b>	6-3/4" X 3-3/16" x 1-3/16" (17.15 x 8.10 x 3.02 cm)	Styrene	<b>98</b>

## By Number Of Compartments: 1 to 36

### BOX MATERIAL KEY





**TP** = Translucent Polypropylene  
**YP** = Yellow Polypropylene  
**WP** = White Polypropylene

**TCP** = Transparent Cellulose Propionate  
**SBMM** = Styrene-Butadiene Methyl Methacrylate  
**SBC** = Styrene-Butadiene Copolymer

**SP** = Taupe Polypropylene  
**OP** = Orange Polypropylene

### SYMBOL KEY

 = Special Order

FIXED COMPS	MODEL #	DIMENSIONS (INSIDE: L x W x D)	MATERIAL	PAGE
7	<b>DB217</b>	7.0" X 3-3/8" x 1-1/8" (17.78 x 8.57 x 2.86 cm)	Styrene	<b>108</b>
7	<b>A607</b>  <b>K607</b> 	10-1/2" X 6-3/16" x 1-9/16" (26.67 x 15.72 x 3.97 cm)	Styrene SBC	<b>111</b> <b>128</b>
7	<b>T7004</b>	15-1/4" X 8-7/8" x 3.0" (38.74 x 22.54 x 7.62 cm)	TP	<b>121</b>
8	<b>A228</b>	4-3/8" x 2-5/8" x 1.0" (11.11 x 6.67 x 2.54 cm)	Styrene	<b>97</b>
8	<b>DB228</b>	4-1/2" X 2-11/16" x 1.0" (11.43 x 6.83 x 2.54 cm)	Styrene	<b>107</b>
8	<b>M808</b> 	12-3/4" X 8-1/2" x 2-1/8" (32.39 x 21.59 x 5.40 cm)	YP	<b>115</b>
9	<b>A210-SL</b> 	6-3/4" X 3-3/16" x 1/2" (17.15 x 8.10 x 1.27 cm)	Styrene	<b>103</b>
9	<b>A210</b> <b>T210</b> <b>K210</b> <b>M210</b>	6-3/4" X 3-3/16" x 1-3/16" (17.15 x 8.10 x 3.02 cm)	Styrene TP SBC YP	<b>98</b> <b>134</b> <b>126</b> <b>113</b>
9	<b>DB210</b>	7.0" X 3-3/8" x 1-1/8" (17.78 x 8.57 x 2.86 cm)	Styrene	<b>107</b>
9	<b>A209</b>	8.0" X 4.0" x 1-3/16" (20.32 x 10.16 x 3.02 cm)	Styrene	<b>99</b>
10	<b>A313-SL</b>	4.0" x 3-2/5" x 1/2" (10.10 x 8.55 x 1.33 cm)	Styrene	<b>103</b>
10	<b>A213-SL</b>	6-3/4" X 3-3/16" x 1/2" (17.15 x 8.10 x 1.27 cm)	Styrene	<b>103</b>

FIXED COMPS	MODEL #	DIMENSIONS (INSIDE: L x W x D)	MATERIAL	PAGE
10	<b>A213</b>	6-3/4" X 3-3/16" x 1-3/16" (17.15 x 8.10 x 3.02 cm)	Styrene	<b>98</b>
10	<b>DB213</b>	7.0" X 3-3/8" x 1-1/8" (17.78 x 8.57 x 2.86 cm)	Styrene	<b>107</b>
11	<b>5127CL</b>	7.0" X 4.0" x 1-1/16" (17.78 x 10.16 x 2.70 cm)	TCP	<b>111</b>
12	<b>A219</b> <b>T219</b> <b>K219</b>	6-3/4" X 3-3/16" x 1-3/16" (17.15 x 8.10 x 3.02 cm)	Styrene TP SBC	<b>98</b> <b>134</b> <b>126</b>
12	<b>DB219</b>	7.0" X 3-3/8" x 1-1/8" (17.78 x 8.57 x 2.86 cm)	Styrene	<b>107</b>
12	<b>A204</b>	8.0" X 4.0" x 1-3/16" (20.32 x 10.16 x 3.02 cm)	Styrene	<b>99</b>
12	<b>A208</b> <b>K208</b> <b>M208</b>	8.0" X 4.0" x 1-3/16" (20.32 x 10.16 x 3.02 cm)	Styrene SBC YP	<b>99</b> <b>127</b> <b>113</b>
12	<b>A201</b> <b>T201</b> <b>K201</b> <b>M201</b>	8.0" X 4.0" x 1-3/16" (20.32 x 10.16 x 3.02 cm)	Styrene TP SBC YP	<b>100</b> <b>134</b> <b>127</b> <b>113</b>
12	<b>DB201</b>	8-7/16" X 4-1/4" x 1-3/16" (21.43 x 10.80 x 3.02 cm)	Styrene	<b>108</b>
12	<b>DB208</b>	8-7/16" X 4-1/4" x 1-3/16" (21.43 x 10.80 x 3.02 cm)	Styrene	<b>108</b>



## By Number Of Compartments: 1 to 36

FIXED COMPS	MODEL #	DIMENSIONS (INSIDE: L x W x D)	MATERIAL	PAGE
12	<b>DB204</b>	8-7/16" X 4-1/4" x 1-3/16" (21.43 x 10.80 x 3.02 cm)	Styrene	<b>108</b>
12	<b>A612</b> ®	10-1/2" X 6-3/16" x 1-9/16"	Styrene	<b>100</b>
	<b>T612</b>	(26.67 x 15.72 x 3.97 cm)	TP	<b>135</b>
	<b>M612</b>		YP	<b>114</b>
12	<b>A602</b>	10-1/2" X 6-3/16" x 1-9/16"	Styrene	<b>100</b>
	<b>T602</b>	(26.67 x 15.72 x 3.97 cm)	TP	<b>135</b>
	<b>K602</b>		SBC	<b>127</b>
	<b>M602</b>		YP	<b>114</b>
12	<b>A612D</b> ®	10-1/2" X 6-3/16" x 2-1/4"	Styrene	<b>101</b>
	<b>T612D</b> ®	(26.67 x 15.72 x 5.72 cm)	TP	<b>136</b>
	<b>K612D</b> ®		SBC	<b>128</b>
	<b>M612D</b> ®		YP	<b>114</b>
12	<b>A812</b>	12-3/4" X 8-1/2" x 2-1/8"	Styrene	<b>102</b>
	<b>K812</b>	(32.39 x 21.59 x 5.40 cm)	SBC	<b>127</b>
	<b>M812</b>		YP	<b>115</b>
13	<b>A623</b> ®	10-1/2" X 6-3/16" x 1-9/16"	Styrene	<b>100</b>
	<b>T623</b>	(26.67 x 15.72 x 3.97 cm)	TP	<b>135</b>
	<b>K623</b> ®		SBC	<b>127</b>
	<b>M623</b>		YP	<b>114</b>
13	<b>A613</b>	10-1/2" X 6-3/16" x 1-9/16"	Styrene	<b>100</b>
		(26.67 x 15.72 x 3.97 cm)		
13	<b>DB613</b>	11.0" X 6-3/8" x 1-9/16"	Styrene	<b>109</b>
		(27.94 x 16.19 x 3.97 cm)		
17	<b>5126CL</b>	7.0" X 4.0" x 1-1/16"	TCP	<b>111</b>
		(17.78 x 10.16 x 2.70 cm)		
18	<b>A200</b>	8.0" X 4.0" x 1-3/16"	Styrene	<b>99</b>
	<b>T200</b>	(20.32 x 10.16 x 3.02 cm)	TP	<b>134</b>
	<b>K200</b>		SBC	<b>126</b>
	<b>M200</b> ®		YP	<b>113</b>
18	<b>DB200</b>	8-7/16" X 4-1/4" x 1-3/16"	Styrene	<b>108</b>
		(21.43 x 10.80 x 3.02 cm)		

FIXED COMPS	MODEL #	DIMENSIONS (INSIDE: L x W x D)	MATERIAL	PAGE
18	<b>A618</b>	10-1/2" X 6-3/16" x 1-9/16"	Styrene	<b>101</b>
	<b>T618</b>	(26.67 x 15.72 x 3.97 cm)	TP	<b>135</b>
	<b>K618</b>		SBC	<b>128</b>
	<b>M618</b>		YP	<b>114</b>
18	<b>A618D</b> ®	10-1/2" X 6-3/16" x 2-1/4"	Styrene	<b>101</b>
	<b>T618D</b> ®	(26.67 x 15.72 x 5.72 cm)	TP	<b>136</b>
	<b>K618D</b> ®		SBC	<b>128</b>
	<b>M618D</b> ®		YP	<b>114</b>
18	<b>DB618</b>	11.0" X 6-3/8" x 1-9/16"	Styrene	<b>109</b>
		(27.94 x 16.19 x 3.97 cm)		
18	<b>A818</b> ®	12-3/4" X 8-1/2" x 2-1/8"	Styrene	<b>102</b>
	<b>K818</b>	(32.39 x 21.59 x 5.40 cm)	SBC	<b>129</b>
	<b>M818</b>		YP	<b>115</b>
24	<b>A924-2</b>	10-9/16" X 8-1/4" x 1-9/16"	Styrene	<b>101</b>
		(26.83 x 20.96 x 3.97 cm)		
24	<b>5129CL</b>	11-15/16" X 5-15/16" x 1-7/16"	TCP	<b>111</b>
		(30.32 x 15.08 x 3.65 cm)		
24	<b>A824</b>	12-3/4" X 8-1/2" x 2-1/8"	Styrene	<b>102</b>
	<b>T824</b>	(32.39 x 21.59 x 5.40 cm)	TP	<b>136</b>
	<b>K824</b>		SBC	<b>128</b>
	<b>M824</b>		YP	<b>115</b>
36	<b>A166-36</b>	9-5/8" X 6-9/16" x 1-1/2"	Styrene	<b>100</b>
	<b>K166-36</b>	(24.45 x 16.69 x 3.81 cm)	SBC	<b>127</b>

**FLAMBEAU® CAPABILITIES:****P: 2 - 5**

- 2-3..... Flambeau® Capability Overview
- 4-5..... Custom Decorating

**ZERUST, ANTI-TARNISH AND DIVIDERS:****P: 6 - 7**

- 6 ..... Zerust® and Anti-Tarnish Rust Protection
- 7 ..... Dividers: General, Zerust® and IDS™

**NEW FROM FLAMBEAU® INC:****P: 8 - 11**

- |   |  |
|---|--|
| 8 ..... Contractor Clipboard                | 10..... Ammo Boxes: Shotgun Gear Boxes |
| 8 ..... Merchant 12", 14" & 19" Cases       | 10..... Gear Box                       |
| 8 ..... Flambeau® Zerust® Toolboxes         | 10..... Atlas 12 Case                  |
| 9 ..... DOCU-BOXES™                         | 11 ..... Double Coverage Rifle Case    |
| 9 ..... Static Dissipative Slim Line™ Boxes | 11 ..... Pallet Packer                 |
| 9 ..... Big Mouth™ Toolbox                  | 11 ..... Shotgun Storage Tray          |

**CASES - SINGLE WALL CASES:****P: 12 - 21**

- |                                       |                        |
|---------------------------------------|------------------------|
| 12-13..... Merchant™ Cases            | 18-19..... Gear Boxes  |
| 14-16..... Tradesman™ Cases & Options | 20..... Black Ribbon™  |
| 17 ..... Shotgun Gear boxes           | 21 ..... Linesman Case |
| 17 ..... Shotgun Storage Tray         |                        |

**CASES - DOUBLE WALL CASES:****P: 22 - 45**

- |                                 |  |
|---------------------------------|--|
| 22-25..... Infinity™ Case       | 40..... Blow Mold Tradesman™ Case        |
| 26-29..... "P" Series Case      | 40..... Beta Case                        |
| 30-32..... The Defender®        | 41..... Double Wall Shipper Mailers      |
| 33-35..... The Aegis Line       | 42..... DOCU-BOXES™                      |
| 36-39..... Airmold® Series Case | 43..... Double Coverage™ Rifle Case      |
| 40 ..... Vision 20™             | 44-45..... Cases - Parts and Accessories |

**WATERPROOF CASES:****P: 46 - 49**

- |                              |                                     |
|------------------------------|-------------------------------------|
| 46 ..... Atlas 12 Case       | 48-49..... Waterproof Tuff Tainers® |
| 47 ..... Waterproof Satchels |                                     |

**FIREARM & WEAPON STORAGE:****P: 50 - 51**

- |                            |                           |
|----------------------------|---------------------------|
| 50-51 ..... Tactical Cases | 51 ..... Suppressor Cases |
|----------------------------|---------------------------|

**RIFLE CASES:****P: 52 - 55**

- |                            |                                     |
|----------------------------|-------------------------------------|
| 52..... Pallet Packer      | 54..... Double Coverage™ Rifle Case |
| 53..... Economy Rifle Case | 55..... Linesman Case               |
| 53..... Single Rifle Case  | 55..... (8) Pistol Linesman Case    |
| 53..... Double Rifle Case  | 55..... Stop Rust Gun Plug          |

**TOOLBOXES - WITH ZERUST®:****P: 56 - 58**

- |   |  |
|---|--|
| 57 ..... 15" Zerust® Dry Box                | 58..... 22" Zerust Toolbox W/Lift-Out Tray |
| 57 ..... 18" Zerust Cantilever Toolbox      | 58..... 26" Zerust Toolbox W/Lift-Out Tray |
| 57 ..... 19" Zerust Toolbox W/Lift-Out Tray | 58..... Contractor Clipboard               |

**TOOLBOXES:****P: 59 - 69**

- |   |                                     |
|---|-------------------------------------|
| 60 ..... Utility Boxes                      | 64-66..... Boxes W/Cantilever Trays |
| 61 ..... Boxes W/Lift-Out Trays & Lock Tabs | 66..... Utility Bench Box           |
| 62 ..... Low Boy™ Toolbox                   | 67..... Tool Chest                  |
| 62 ..... Expandable Building Box            | 68..... Big Mouth™ Toolbox          |
| 62 ..... Expansion Kit for Building Box     | 69..... Double Wall Small Toolbox   |
| 63 ..... Lil' Brute Toolbox                 | 69..... Double Wall Large Toolbox   |
| 63 ..... Utility Tote                       |                                     |

**SATCHEL BOXES:****P: 70 - 74**

- |                                     |                                     |
|-------------------------------------|-------------------------------------|
| 70 ..... Industrial Satchels: Large | 72-73..... Deep Super Satchel™      |
| 71 ..... Industrial Satchels: Small | 73..... Double Deep™ Super Satchel™ |
| 72 ..... Slim Super Satchel™        | 74..... Deluxe Super Satchel™       |

**CABINETS & DRAWER STORAGE:****P: 75 - 82**

- |  |                                      |
|--|--------------------------------------|
| 75 ..... IDS™ Cabinets (Infinite Divider System) | 80..... Utility Workstation™ Cart    |
| 76-77 ..... Drawer Cabinets                      | 80..... Bin Storage Systems          |
| 78 ..... Parts Station Storage Cabinets          | 81..... Rolling Tote Storage Cabinet |
| 79 ..... Stand 'N Store™                         | 82..... Carry Packs™                 |
| 79 ..... Expandable Tube                         |                                      |

**MEDICAL STORAGE:****P: 83 - 89**

- |  |  |
|--|--|
| 84 ..... Paramedic Gear Box            | 86..... Trauma Drug Kits                     |
| 84 ..... Paramedic Case, Paramedic Box | 87..... Drawer Cabinets                      |
| 85 ..... First Aid Cases               | 88..... Medical Device Box, Instrument Boxes |
| 85 ..... Command Center Box            | 89..... Secure-Lock™ Case                    |

**STATIC DISSIPATIVE & CONDUCTIVE: P: 90 - 94**

90 .....Static Dissipative Slim Line™ Box      92-93 .....Conductive Storage Cabinets  
91 .....Conductive Cases      94 .....600 / 800 Box Series

**SQUARE BOXES: P: 95**

95 .....4" x 6" Box      95 .....6" x 6" Box  
95 .....12" x 12" Box      95 .....Medical Device Box

**COMPARTMENT BOXES - A-SERIES: P: 96 - 102**

97 .....Sizes: 4-1/4 dia. x 3/4" (10.80 dia. x 1.91 cm) - 5-5/8" x 2-15/16" x 1-1/8" (14.29 x 7.46 x 2.86 cm)  
98-99 .....Sizes: 5-7/8" x 3-3/4" x 1-5/8" (14.92 x 9.53 x 4.13 cm) - 8.0" x 4.0" x 1-3/16" (20.32 x 10.16 x 3.02 cm)  
100-101 .....Sizes: 8.0" x 4.0" x 1-3/16" (20.32 x 10.16 x 3.02 cm) - 10-9/16" x 8-1/4" x 1-9/16" (26.83 x 20.96 x 3.97 cm)  
102 .....Sizes: 12-3/4" x 8-1/2" x 2-1/8" (32.39 x 21.59 x 5.40 cm)

**COMPT BOXES - A-SERIES: SLIM LINE™ BOXES: P: 103**

103 .....Sizes: 4.0" x 3-2/5" x 1/2" (10.10 x 8.55 x 1.33 cm) - 6-3/4" x 3-3/16" x 1/2" (17.15 x 8.10 x 1.27 cm)

**COMPT BOXES - PRECISION SERIES: P: 104 - 105**

105 .....Sizes: 3-11/16" x 2-9/16" x 13/16" (9.37 x 6.51 x 2.06 cm) - 8-3/4" x 4-5/16" x 1-1/4" (22.23 x 10.95 x 3.18 cm)

**COMPT BOXES - DIAMONDBACK™ SERIES: P: 106 - 109**

107 .....Sizes: 4-1/2" x 2-11/16" x 1.0" (11.43 x 6.83 x 2.54 cm) - 7.0" x 3-3/8" x 1-1/8" (17.78 x 8.57 x 2.86 cm)  
108-109 .....Sizes: 7.0" x 3-3/8" x 1-1/8" (17.78 x 8.57 x 2.86 cm) - 11.0" x 6-3/8" x 1-9/16" (27.94 x 16.19 x 3.97 cm)

**COMPT BOXES - MIGHTY-TUFF™ SERIES: P: 110 - 111**

111 .....Sizes: 4-5/16" x 2-5/8" x 1-1/16" (10.95 x 6.67 x 2.70 cm) - 11-15/16" x 5-15/16" x 1-7/16" (30.32 x 15.08 x 3.65 cm)

**COMPT BOXES - M-SERIES: P: 112 - 115**

113 .....Sizes: 4-3/8" x 2-5/8" x 1.0" (11.11 x 6.67 x 2.54 cm) - 8.0" x 4.0" x 1-3/16" (20.32 x 10.16 x 3.02 cm)  
114-115 .....Sizes: 10-1/2" x 6-3/16" x 1-9/16" (26.67 x 15.72 x 3.97 cm) - 12-3/4" x 8-1/2" x 2-1/8" (32.39 x 21.59 x 5.04 cm)

**COMPT BOXES - V-SERIES: P: 116 - 117**

117 .....Sizes: 6-7/8" x 2-1/16" x 1.0" (17.46 x 5.24 x 2.54 cm) - 17.0" x 7-1/8" x 2.0" (43.18 x 18.10 x 5.08 cm)

**COMPT BOXES - TUFF TAINER®-SERIES: P: 118 - 121**

119 .....Sizes: 4-5/16" x 2-5/8" x 1-1/8" (10.95 x 6.67 x 2.86 cm) - 10-1/2" x 6-1/4" x 1-1/2" (26.67 x 15.88 x 3.81 cm)  
120-121 .....Sizes: 12.0" x 4.0" x 1-1/16" (30.48 x 10.16 x 2.70 cm) - 15-1/4" x 8-7/8" x 3.0" (38.74 x 22.54 x 7.62 cm)

**COMPT BOXES - TUFF TAINER®: WATERPROOF: P: 122 - 123**

123 .....Sizes: 7-5/8" x 3-9/16" x 1.0" (19.38 x 9.05 x 2.54 cm) - 12-1/2" x 7-1/2" x 2-5/16" (31.75 x 19.05 x 5.88 cm)

**COMPT BOXES - K-SERIES: P: 124 - 129**

125 .....Sizes: 4-3/8" x 2-5/8" x 1.0" (11.11 x 6.67 x 2.54 cm) - 8.0" x 4.0" x 1-3/16" (20.32 x 10.16 x 3.02 cm)  
126-127 .....Sizes: 8.0" x 4.0" x 1-3/16" (20.32 x 10.16 x 3.02 cm) - 12-3/4" x 8-1/2" x 2-1/8" (32.39 x 21.59 x 5.40 cm)  
128 .....Sizes: 12-3/4" x 8-1/2" x 2-1/8" (32.39 x 21.59 x 5.40 cm)

**COMPT BOXES - IDS™-SERIES: P: 130 - 131**

131 .....Sizes: 6-5/8" x 3-3/8" x 1-5/16" (16.83 x 8.57 x 3.33 cm) - 13-1/8" x 8-7/8" x 1-15/16" (33.34 x 22.54 x 4.92 cm)

**COMPT BOXES - T-SERIES: P: 132 - 135**

133 .....Sizes: 4.0" x 3-3/8" x 13/16" (10.16 x 8.57 x 2.06 cm) - 8.0" x 4.0" x 1-3/16" (20.32 x 10.16 x 3.02 cm)  
134-135 .....Sizes: 8.0" x 4.0" x 1-3/16" (20.32 x 10.16 x 3.02 cm) - 13-1/8" x 8-7/8" x 1-15/16" (33.34 x 22.54 x 4.92 cm)

**BY SIZE - OF COMPARTMENTS: P: 136 - 140**

136-137 .....Sizes: 3-11/16" x 2-9/16" x 13/16" (9.37 x 6.51 x 2.06 cm) - 7-1/8" x 5-1/8" x 1-9/16" (18.10 x 13.02 x 3.97 cm)  
138-139 .....Sizes: 8.0" x 4.0" x 1-3/16" (20.32 x 10.16 x 3.02 cm) - 11.0" x 6-3/8" x 1-9/16" (27.94 x 16.19 x 3.97 cm)  
140 .....Sizes: 11-15/16" x 5-15/16" x 1-7/16" (30.32 x 15.08 x 3.65 cm) - 17.0" x 7-1/8" x 2.0" (43.18 x 18.10 x 5.08 cm)

**BY NUMBER - OF COMPARTMENTS: P: 141 - 145**

141 .....Sizes: (1) 3-11/16" x 2-9/16" x 13/16" (9.37 x 6.51 x 2.06 cm) - 12-1/2" x 7-1/2" x 2-5/16" (31.75 x 19.05 x 5.88 cm)  
142 .....Sizes: (1 - 4) 12-3/4" x 8-1/2" x 2-1/8" (32.39 x 21.59 x 5.40 cm) - 13-11/16" x 8-3/16" x 1-3/4" (34.77 x 20.80 x 4.45 cm)  
143 .....Sizes: (4 - 7) 13-11/16" x 8-3/16" x 1-3/4" (34.77 x 20.80 x 4.45 cm) - 6-3/4" x 3-3/16" x 1-3/16" (17.15 x 8.10 x 3.02 cm)  
144 .....Sizes: (7 - 12) 7.0" x 3-3/8" x 1-1/8" (17.78 x 8.57 x 2.86 cm) - 8-7/16" x 4-1/4" x 1-3/16" (21.43 x 10.80 x 3.02 cm)  
145 .....Sizes: (12 - 36) 8-7/16" x 4-1/4" x 1-3/16" (21.43 x 10.80 x 3.02 cm) - 9-5/8" x 6-9/16" x 1-1/2" (24.45 x 16.69 x 3.81 cm)

**NOTES:**  
\_\_\_\_\_  
\_\_\_\_\_  
\_\_\_\_\_  
\_\_\_\_\_  
\_\_\_\_\_  
\_\_\_\_\_





**F Flambeau** INC.  
A MEMBER OF THE NORDIC GROUP OF COMPANIES

Customer Service: (800) 344-5716  
15981 Valplast Street, Middlefield, Ohio 44062  
Ph: (440) 632-1631 • Fax: (440) 632-1581

**F Flambeau Europlast**™ Ltd

Manston Road, Ramsgate, Kent. CT12 6HW, UK  
Tel: +44 (0)1843-854000 • Fax: +44 (0) 1843-854046

Check out our site: [flambeaucases.com](http://flambeaucases.com)

For your convenience and order processing speed we accept:



Zerust® is a registered trademark of Northern Technologies International Corporation. Company names and logos within this catalog are used with permission and are registered trademarks of the respective companies. © 2021 Flambeau® Inc. All Rights Reserved.

9565PS (5M) 1-21