

# UM11304

## KITVR5500AEEVM evaluation board for devices VR5500 and FS5502

Rev. 1 — 4 November 2019

User guide

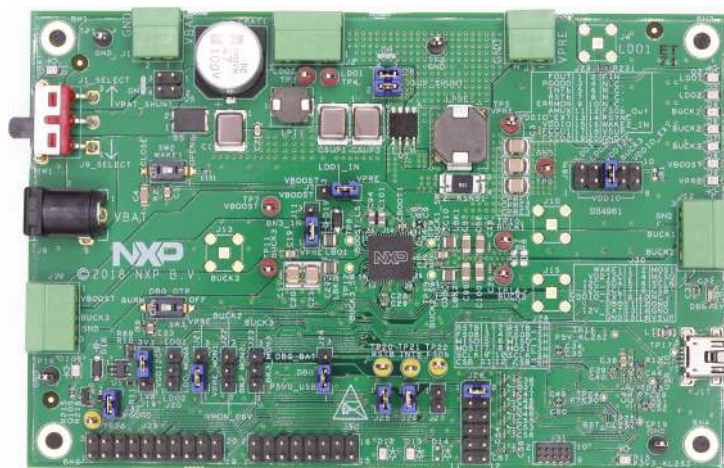

Figure 1. KITVR5500AEEVM

### Important Notice

NXP provides the enclosed product(s) under the following conditions:

This evaluation kit is intended for use of ENGINEERING DEVELOPMENT OR EVALUATION PURPOSES ONLY. It is provided as a sample IC pre-soldered to a printed circuit board to make it easier to access inputs, outputs, and supply terminals. This evaluation board may be used with any development system or other source of I/O signals by simply connecting it to the host MCU or computer board via off-the-shelf cables. This evaluation board is not a Reference Design and is not intended to represent a final design recommendation for any particular application. Final device in an application will be heavily dependent on proper printed circuit board layout and heat sinking design as well as attention to supply filtering, transient suppression, and I/O signal quality.

The goods provided may not be complete in terms of required design, marketing, and or manufacturing related protective considerations, including product safety measures typically found in the end product incorporating the goods. Due to the open construction of the product, it is the user's responsibility to take any and all appropriate precautions with regard to electrostatic discharge. In order to minimize risks associated with the customers applications, adequate design and operating safeguards must be provided by the customer to minimize inherent or procedural hazards. For any safety concerns, contact NXP sales and technical support services.

Should this evaluation kit not meet the specifications indicated in the kit, it may be returned within 30 days from the date of delivery and will be replaced by a new kit.

NXP reserves the right to make changes without further notice to any products herein. NXP makes no warranty, representation or guarantee regarding the suitability of its products for any particular purpose, nor does NXP assume any liability arising out of the application or use of any product or circuit, and specifically disclaims any and all liability, including without limitation consequential or incidental damages. Typical parameters can and do vary in different applications and actual performance may vary over time. All operating parameters, including Typical, must be validated for each customer application by customer's technical experts.

NXP does not convey any license under its patent rights nor the rights of others. NXP products are not designed, intended, or authorized for use as components in systems intended for surgical implant into the body, or other applications intended to support or sustain life, or for any other application in which the failure of the NXP product could create a situation where personal injury or death may occur.

Should the Buyer purchase or use NXP products for any such unintended or unauthorized application, the Buyer shall indemnify and hold NXP and its officers, employees, subsidiaries, affiliates, and distributors harmless against all claims, costs, damages, and expenses, and reasonable attorney fees arising out of, directly or indirectly, any claim of personal injury or death associated with such unintended or unauthorized use, even if such claim alleges NXP was negligent regarding the design or manufacture of the part.



## 1 Introduction

---

This document is the user guide for the KITVR5500AEEVM evaluation board. KITVR5500AEEVM is applicable for the devices VR5500 and FS5502. This document is intended for the engineers involved in the evaluation, design, implementation, and validation of VR5500/FS5502 high voltage PMIC with multiple SMPS and LDO.

The scope of this document is to provide the user with information to evaluate the VR5500/FS5502 high voltage PMIC with multiple SMPS and LDO. This document covers connecting the hardware, installing the software and tools, configuring the environment and using the kit.

The KITVR5500AEEVM enables development on VR5500/FS5502 devices. The kit can be connected to the FlexGUI software which allows you to play with registers, try OTP configurations, and burn the part.

This kit is suitable for truck application running at 24 V nominal. It is able to sustain up to 60 V at  $V_{BAT}$ .

It is delivered with empty OTP content in order to leave the opportunity to the user to burn the OTP configuration. Burning the OTP three times, gives a good flexibility. The board allows testing on all the VR5500/FS5502 derivatives.

## 2 Finding kit resources and information on the NXP website

---

NXP Semiconductors provides online resources for this evaluation board and its supported devices on <http://www.nxp.com>.

The information page for KITVR5500AEEVM evaluation board is at <http://www.nxp.com/KITVR5500AEEVM>. The information page provides overview information, documentation, software and tools, parameters, ordering information and a **Getting Started** tab. The **Getting Started** tab provides quick-reference information applicable to using the KITVR5500AEEVM evaluation board, including the downloadable assets referenced in this document.

### 2.1 Collaborate in the NXP community

The NXP community is for sharing ideas and tips, ask and answer technical questions, and receive input on just about any embedded design topic.

The NXP community is at <http://community.nxp.com>.

## 3 Getting ready

---

Working with the KITVR5500AEEVM requires the kit contents, additional hardware, and a Windows PC workstation with installed software.

### 3.1 Kit contents

- Assembled and tested evaluation board in an anti-static bag
- 3.0 ft USB-STD A to USB-B-mini cable
- Two connectors, terminal block plug, 2 pos., str. 3.81 mm
- Three connectors, terminal block plug, 3 pos., str. 3.81 mm
- Jumpers mounted on board

### 3.2 Additional hardware

In addition to the kit contents, the following hardware is necessary or beneficial when working with this kit.

- Power supply with a range of 8.0 V to 60 V and a current limit set initially to 1.0 A

### 3.3 Windows PC workstation

This evaluation board requires a Windows PC workstation. Meeting these minimum specifications should produce great results when working with this evaluation board.

- USB-enabled computer with Windows 7 or Windows 10

### 3.4 Software

Installing software is necessary to work with this evaluation board. All listed software is available on the information page of the evaluation board at <http://www.nxp.com/KITVR5500AEEVM> or from the provided link.

- FlexGUI latest version
- VR5500\_OTP\_Config.xlsm or FS5502\_OTP\_Config.xlsm
- Java installation <https://www.oracle.com/technetwork/java/javase/downloads/jre8-downloads-2133155.html>

## 4 Getting to know the hardware

The KITVR5500AEEVM provides flexibility to play with all the features of the device and make measurements on the main part of the application. The KL25Z MCU installed on the board, combined with the FlexGUI software allows access to the registers in read and write mode. All regulators are accessible through connectors. Nonuser signals, like DC-to-DC switcher node are mapped on test points. Digital signals (I2C, RSTB, etc.) are accessible through connectors. Pin WAKE1 has a switch to control (ignition) them. A  $V_{BAT}$  switch is available to power on or off the device.

This kit can be operated in Emulation mode or in OTP mode. In Emulation mode, as long as the power is supplied, the board configuration stays valid. The OTP mode uses the fused configuration. The device can be fused three times. In OTP mode, the device always starts with the fused configuration, except if the user wants to overwrite OTP configuration using Emulation mode. This board is able to fuse the OTP without any extra tools or board.

## 4.1 Kit overview

The KITVR5500AEEVM is a hardware evaluation tool that allows performance test. The VR5500/FS5502 part soldered on the board can be fused three times (see [Section 7.3](#)).

An Emulation mode is possible to test as many configurations as needed. The voltage monitoring hardware configuration is done through resistors. Note that this configuration can be changed by selecting the appropriate bridges resistors:

- VMON1: assigned to VPRE, 3.3 V for VR5500 in default, adjust bridge resistors for FS5502

This board was designed to sustain up to 10 A total on VPRE. Layout is done using six layer PCB stack up.

The VR5500/FS5502 family can be evaluated with this board as it is populated with a superset part. They are pin to pin and software compatible with FS84 (fit for ASIL-B) and FS85 (fit for ASIL-D).

An external LDO provides VDDI2C voltage with a choice of 1.8 V or 3.3 V (default). VDDIO is assigned by default to VDDI2C. From USB voltage, an external DC-to-DC generates the OTP programming voltage (8.0 V) without any need for an external power supply.

**Table 1. VR5500 and FS5502 comparison**

Function	VR5500	FS5502
BUCK1	yes	yes
BUCK2	yes	no
BUCK3	yes	yes
BOOST	yes	no
LDO1	yes	yes
LDO2	yes	no
WAKE1/2	yes	yes
AMUX	yes	no
FIN/FOUT	yes	yes
I2C	yes	yes
PGOOD/RSTB	yes	yes
VCORE monitoring (VCOREMON)	yes	yes
VDDIO monitoring	yes	yes
VMON1	yes	yes
ASIL	QM	QM

4.1.1 KITVR5500AEEVM features

- VBAT power supply connectors (Jack and Phoenix)
- VPRE output capability up to 10 A (external MOSFET)
- VBUCK1/2 in Standalone mode (default) or Multiphase mode (VBUCK2 only for VR5500)
- VBUCK3 up to 3.6 A peak
- VBOOST 5.0 V or 5.74 V, up to 800 mA (VR5500 only)
- LDO1 and LDO2, from 1.1 V to 5.0 V, up to 400 mA (LDO2 only for VR5500)
- Ignition key switch
- Embedded USB connection for easy connection to software GUI (access to I<sup>2</sup>C-bus, IOs, RSTB, INTB, Debug, MUX\_OUT (VR5500 only), regulators)
- LEDs that indicate signal or regulator status
- Support OTP fuse capabilities
- USB connection for register access, OTP emulation, and programming

4.1.2 VMON1 board configuration

VMON1 is a general-purpose voltage monitoring input. VMON1 can be connected to VPRE, LDO1, LDO2, BUCK3, BUCK2 (in case BUCK2 is not used in multiphase), or even an external regulator. This kit is delivered with VMON1 assigned to VPRE of VR5500, the bridge resistor set for 3.3 V.

Due to the jumpers, VMON1 can be tied to a 0.8 V to force a good voltage at pin level. It behaves like hardware disabling and makes debug easy in some cases.

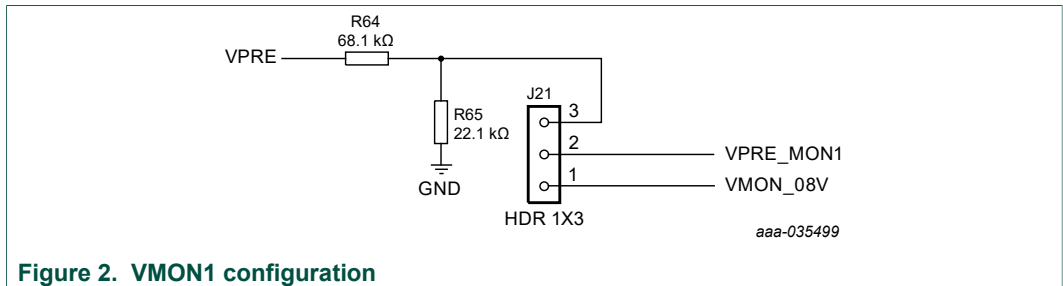

Figure 2. VMON1 configuration

4.1.3 VPRE compensation network

This board is delivered with a VPRE compensation network defined for VPRE 4.1 V at 450 kHz. All other VPRE configurations require a new calculation for these components.

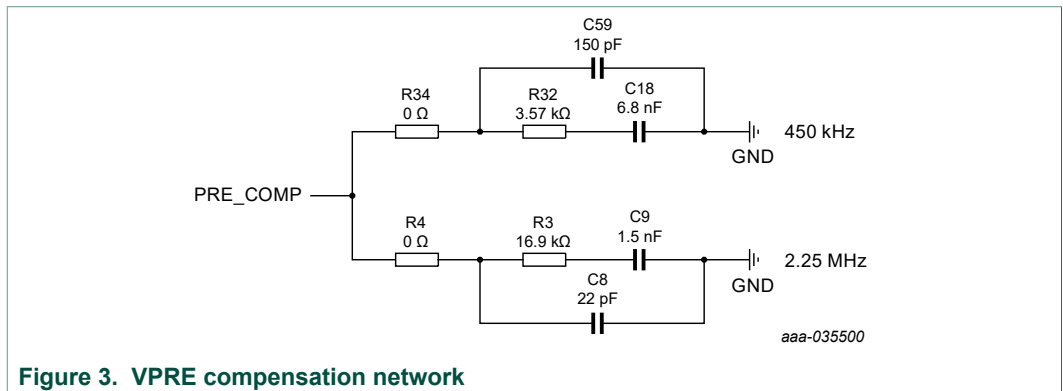

Figure 3. VPRE compensation network

Table 2. Compensation network

Components	VPRE 450 kHz	VPRE 2.2 MHz
C18/C9	6.8 nF	1.5 nF
C59/C8	150 pF	22 pF
R32/R3	3.57 kΩ	16.9 kΩ

4.1.4 BUCK1 and BUCK2 multiphase configuration (VR5500 only)

The board is designed to work independently with BUCK1 and BUCK2. Due to R7 and R8, it is possible to connect both connectors together and work in multiphase.

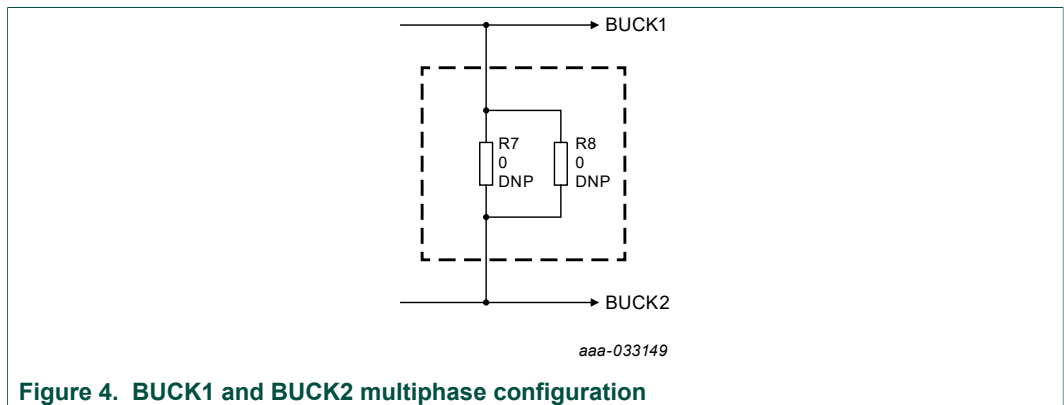

Figure 4. BUCK1 and BUCK2 multiphase configuration

4.1.5 VDDI2C

As an option, an external LDO is provided to feed VDDI2C. This LDO can also be used to feed VDDIO, which is the default implementation.

The I<sup>2</sup>C-bus is compatible with 1.8 V or 3.3 V, while VDDIO is compatible with 3.3 V and 5.0 V. For this reason, the LDO default configuration is 3.3 V. The LDO is supplied by 5.0 V coming from the USB.

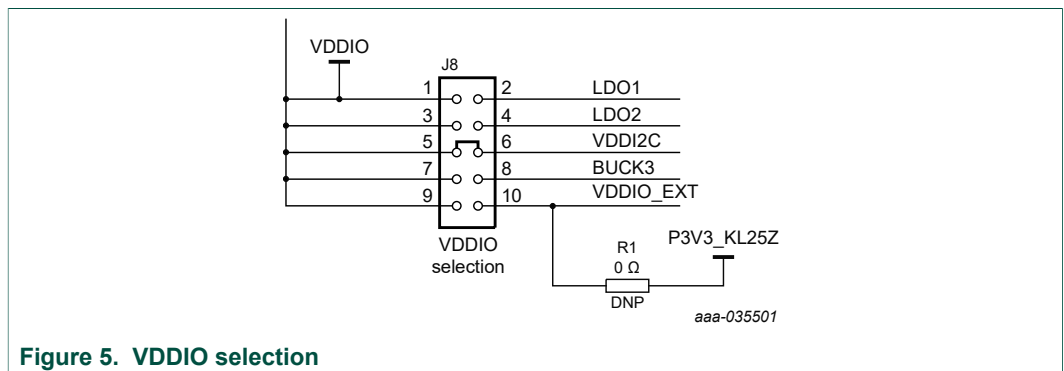

Figure 5. VDDIO selection

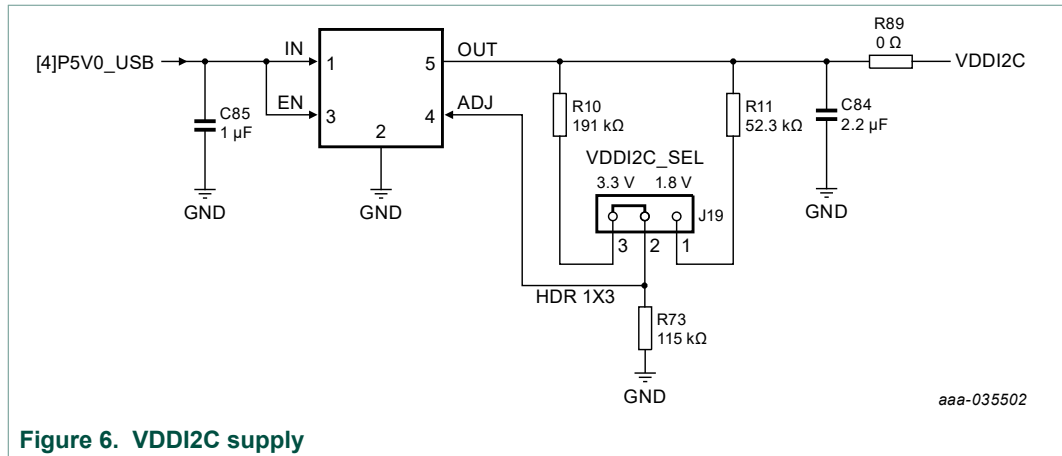

Figure 6. VDDI2C supply

## 4.2 Device OTP user configuration

It is recommended to learn about OTP before operating with the device. The device has a high level of flexibility due to parameter configuration available in the OTP, which impacts the functionality of the device. It is key to understand how OTP parameters can be programmed, the interaction with mirror registers and the VR5500/FS5502 SoC.

The OTP related operations can be performed either in Emulation mode, where the product uses a given configuration as long as power supply is not switched off or from OTP fuse content that is valid even after a power down/power up sequence.

### 4.2.1 OTP and mirrors registers

There are two OTP blocks in the device. One is for the main section, and the other for the fail-safe. During configuration, each of them are using dedicated sectors. The OTP configuration scheme is shown in [Figure 7](#) (same implementation for main and fail-safe).

The device can be fused three times using mirror registers. The user can first load the mirror register content with the desired contents, then decide either to use the device in Emulation mode or to burn the next sector. The first sector to be burned is S1, the second S1bis, and the third S1ter. FlexGUI automatically manages the next sector to be burned. It is not possible to revert to the previous sector. When the user reaches the sector S1ter, there no other possibility for burn, however emulation mode is still available.

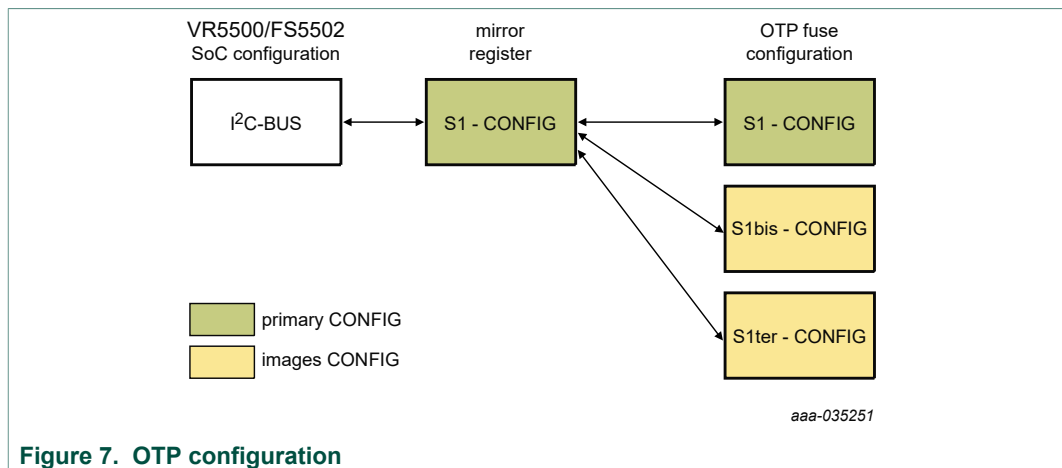

Figure 7. OTP configuration

At boot, the content of the valid sector is loaded into the Mirror Register Sector 1. The mirror register content is accessible from FlexGUI by using specific I<sup>2</sup>C-bus commands. The mirror configuration is managed by the FlexGUI, which eases the access.

### 4.2.2 OTP hardware implementation

To work in OTP emulation or OTP programming, it is required to start the device in Debug mode.

Figure 8 shows the sequence to be followed to enter in Debug mode. The voltage sequence on the kit is done using switches installed on the board, while the OTP registers configuration is managed by the FlexGUI. It is described in detail in the following sections.

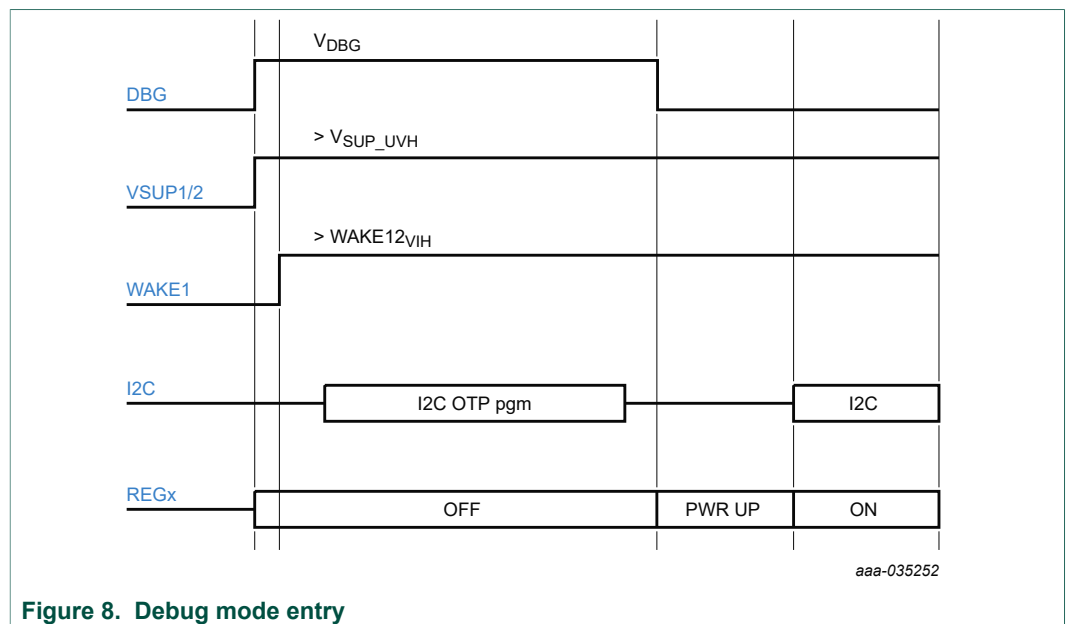

Figure 8. Debug mode entry





4.3 Kit featured components

Figure 10 identifies important components on the board and Table 3 provides additional details on these components.

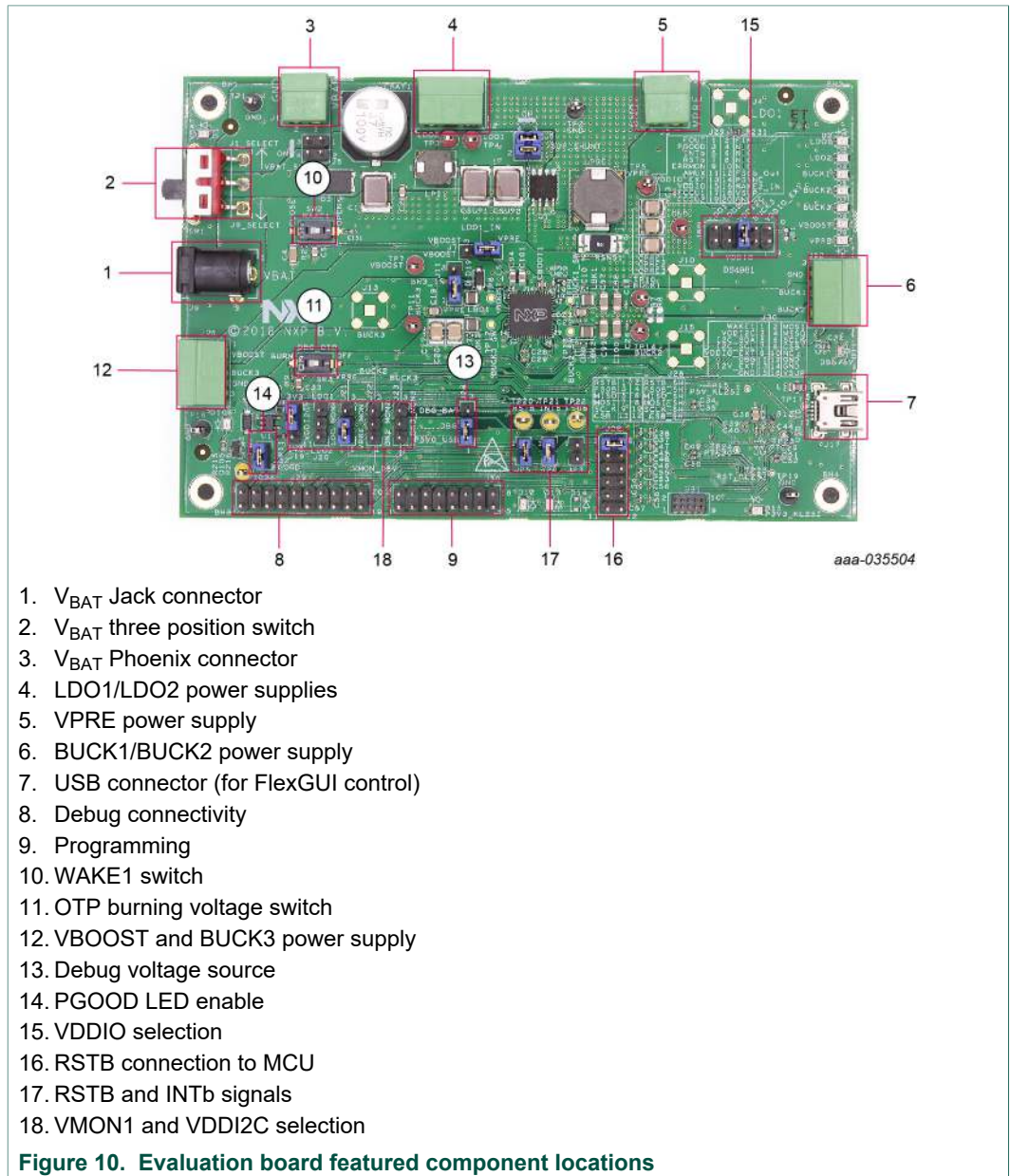

1. V<sub>BAT</sub> Jack connector
2. V<sub>BAT</sub> three position switch
3. V<sub>BAT</sub> Phoenix connector
4. LDO1/LDO2 power supplies
5. VPRE power supply
6. BUCK1/BUCK2 power supply
7. USB connector (for FlexGUI control)
8. Debug connectivity
9. Programming
10. WAKE1 switch
11. OTP burning voltage switch
12. VBOOST and BUCK3 power supply
13. Debug voltage source
14. PGOOD LED enable
15. VDDIO selection
16. RSTB connection to MCU
17. RSTB and INTb signals
18. VMON1 and VDDI2C selection

Figure 10. Evaluation board featured component locations

Table 3. Evaluation board component descriptions

Number	Description
1	V <sub>BAT</sub> Jack connector
2	V <sub>BAT</sub> three position switch <ul style="list-style-type: none"> <li>• Left position: board supplied by Jack connector</li> <li>• Middle position: board not supplied</li> <li>• Right position: board supplied by Phoenix connector</li> </ul>
3	V <sub>BAT</sub> Phoenix connector
4	LDO1/LDO2 power supplies
5	VPRE power supply
6	BUCK1/BUCK2 power supply
7	USB connector (for FlexGUI control)
8	debug connectivity; access to: <ul style="list-style-type: none"> <li>• VSUP, GND</li> <li>• FOUT/FIN</li> <li>• PGOOD/RST</li> <li>• WAKE2</li> <li>• PSYNC, AMUX</li> <li>• VMON1</li> </ul>
9	programming <ul style="list-style-type: none"> <li>• I<sup>2</sup>C-bus</li> <li>• Pin DBG</li> <li>• VPRE, VSUP, GND</li> </ul>
10	WAKE1 switch
11	OTP burning voltage switch
12	VBOOST and BUCK3 power supply
13	debug voltage source either from USB (recommended) or from VSUP
14	PGOOD LED indicator (enabled when jumper is plugged)
15	VDDIO source from device regulators or external sources
16	RSTB can be disconnected between device and MCU
17	RSTB and INTb signals available here (device pin level)
18	allows user to select VMON1 from regulators or a fix 0.8 V; VDDI2C can be selected either 1.8 V or 3.3 V

### 4.3.1 VR5500/FS5502: high voltage PMIC with multiple SMPS and LDO

#### 4.3.1.1 General description

The VR5500/FS5502 are automotive high-voltage multi-output power supply integrated circuits, with focus on radio, V2X, and infotainment applications. They include multiple switch mode and linear voltage regulators. They offer external frequency synchronization input and output, for optimized system EMC performance.

Several device versions are available, offering choice in number of output rails, output voltage setting, operating frequency, and power up sequencing, to address multiple applications.

#### 4.3.1.2 Features

- 60 V DC maximum input voltage for 12 V and 24 V applications
- VPRE synchronous buck controller with external MOSFETs. Configurable output voltage, switching frequency, and current capability up to 10 A peak.
- Low voltage integrated synchronous BUCK1 converter, dedicated to MCU core supply with SVS capability. Configurable output voltage and current capability up to 3.6 A peak.
- **VR5500 only:** Low voltage integrated synchronous BUCK2 converter. Configurable output voltage and current capability up to 3.6 A peak. Multi-phase capability with BUCK1 to extend the current capability up to 7.2 A peak on a single rail. Static voltage scaling capability.
- **Based on part number:** Low voltage integrated synchronous BUCK3 converter. Configurable output voltage and current capability up to 3.6 A.
- **VR5500 only:** BOOST converter with integrated low-side switch. Configurable output voltage and max input current up to 1.5 A peak.
- EMC optimization techniques including SMPS frequency synchronization, spread spectrum, slew rate control, manual frequency tuning
- Two linear voltage regulators for MCU IOs and ADC supply, external physical layer. Configurable output voltage and current capability up to 400 mA DC (one linear voltage regulator on FS5502).
- OFF mode with very low sleep current (10  $\mu$ A typ)
- Two input pins for wake-up detection and battery voltage sensing
- Device control via 32 bits I<sup>2</sup>C-bus interface with CRC
- Power synchronization pin to operate two VR5500/FS5502 devices or VR5500/FS5502 plus an external PMIC
- Power good, reset, and interrupt outputs
- Configuration by OTP programming. Prototype enablement to support custom setting during project development in engineering mode.

4.3.2 Indicators

The following LEDs are provided as visual output devices for the evaluation board:

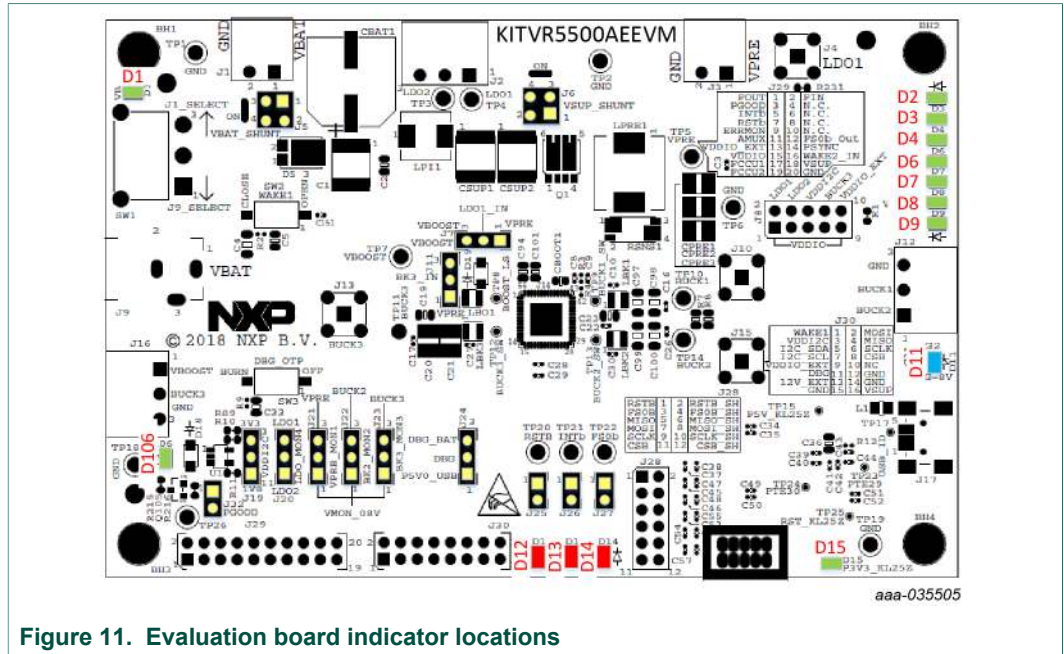

Figure 11. Evaluation board indicator locations

Table 4. Evaluation board indicator descriptions

Label	Name	Color	Description
D1	V <sub>BAT</sub>	green	V <sub>BAT</sub> on
D2	LDO1	green	LDO1 on
D3	LDO2	green	LDO2 on
D4	BUCK1	green	BUCK1 on
D6	BUCK2	green	BUCK2 on
D7	BUCK3	green	BUCK3 on
D8	VBOOST	green	VBOOST on
D9	V <sub>PRE</sub>	green	V <sub>PRE</sub> on
D11	DBG > 8.0 V	blue	DBG pin voltage > 8.0 V (OTP programming)
D12	RSTB	red	RSTB asserted (logic level = 0)
D13	INTb	red	INTb asserted (logic level = 0)
D14	FS0b	red	not available
D15	P3V3_KL25	green	P3V3_KL25 on
D106	PGOOD	green	PGOOD released

4.3.3 Connectors

Figure 12 shows the location of connectors on the board.

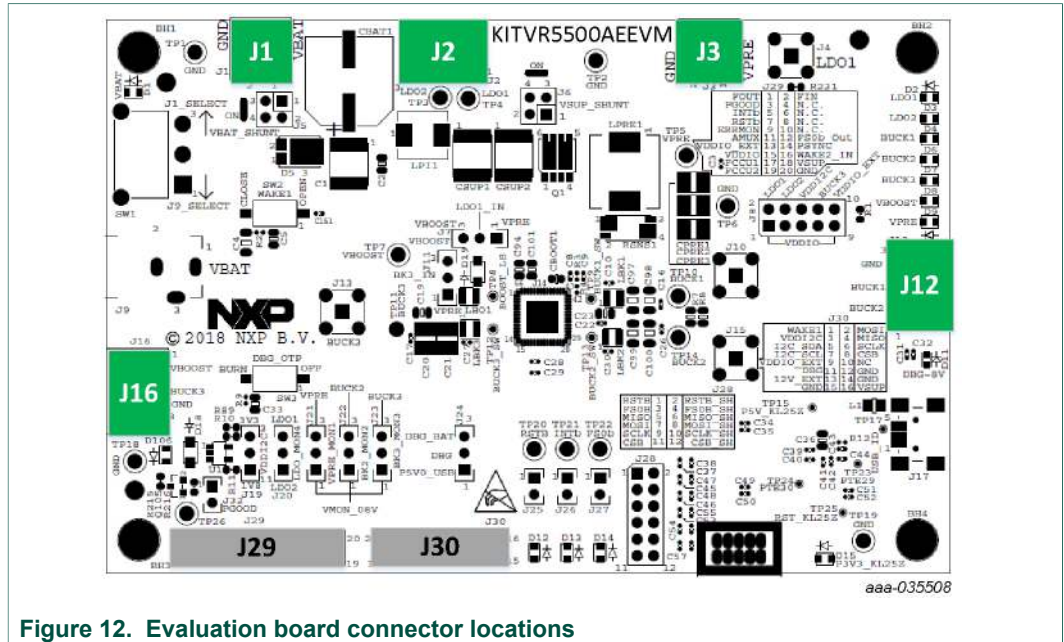

Figure 12. Evaluation board connector locations

4.3.3.1 V<sub>BAT</sub> connector (J1)

V<sub>BAT</sub> connects to the board through Phoenix connector (J1).

Table 5. V<sub>BAT</sub> Phoenix connector (J1)

Schematic label	Signal name	Description
J1-1	V <sub>BAT</sub>	battery voltage supply input
J1-2	GND	ground

4.3.3.2 Output power supply connectors

Table 6. BUCK1/BUCK2 connector (J12)

Schematic label	Signal name	Description
J12-1	BUCK2	BUCK2 power supply output
J12-2	BUCK1	BUCK1 power supply output
J12-3	GND	ground

Table 7. VBOOST/BUCK3 connector (J16)

Schematic label	Signal name	Description
J16-1	VBOOST	VBOOST output
J16-2	BUCK3	BUCK3 power supply output
J16-3	GND	ground

**Table 8. LDO1/LDO2 connector (J2)**

Schematic label	Signal name	Description
J2-1	LDO1	LDO1 power supply output
J2-2	LDO2	LDO2 power supply output
J2-3	GND	ground

**Table 9. VPRE connector (J3)**

Schematic label	Signal name	Description
J3-1	VPRE	VPRE power supply output
J3-2	GND	ground

**4.3.3.3 Debug connector (J29)**

**Table 10. Debug connector (J29)**

Schematic label	Signal name	Description
J29-1	FOUT	frequency synchronization output
J29-2	FIN	frequency synchronization input
J29-3	PGOOD	power GOOD
J29-4	n.c.	not connected
J29-5	INTb	interrupt, active LOW
J29-6	n.c.	not connected
J29-7	RSTB	reset, active LOW
J29-8	n.c.	not connected
J29-9	n.c.	not connected
J29-10	n.c.	not connected
J29-11	AMUX	analog multiplexer
J29-12	n.c.	not connected
J29-13	VDDIO_EXT	VDDIO external reference
J29-14	PSYNC	power synchronization
J29-15	VDDIO	VDDIO used by VR5500/FS5502
J29-16	WAKE2_IN	WAKE2 input
J29-17	n.c.	not connected
J29-18	VSUP	VSUP power supply
J29-19	n.c.	not connected
J29-20	GND	ground

4.3.3.4 Program connector (J30)

Table 11. Program connector (J30)

Schematic label	Signal name	Description
J30-1	WAKE1	WAKE1 input
J30-2	n.c.	not connected
J30-3	VDDI2C	VDDI2C voltage
J30-4	n.c.	not connected
J30-5	I2C_SDA	I <sup>2</sup> C-bus serial data
J30-6	n.c.	not connected
J30-7	I2C_SCL	I <sup>2</sup> C-bus serial clock
J30-8	n.c.	not connected
J30-9	VDDIO_EXT	VDDIO supplied from external regulator
J30-10	VPRE	VPRE output
J30-11	DBG	connected to pin DBG
J30-12	GND	ground
J30-13	n.c.	not connected
J30-14	VSUP	connected to VSUP pin
J30-15	GND	ground
J30-16	GND	ground

4.3.4 Test points

The following test points provide access to various signals to and from the board.

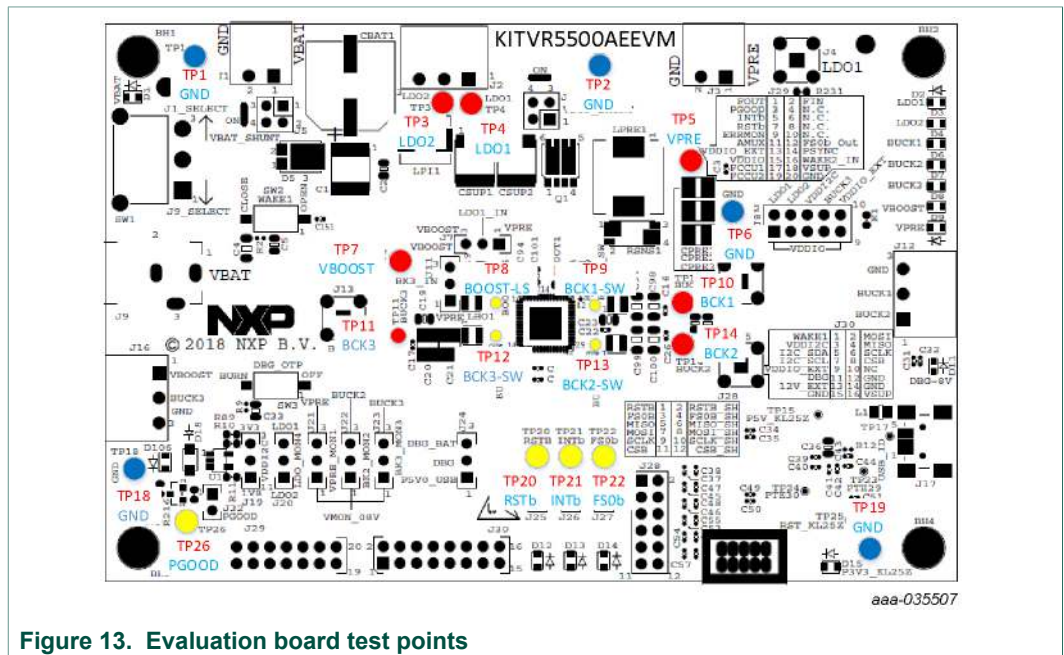



Table 12. Evaluation board test point descriptions

Test point name	Signal name	Description
TP1	GND	ground
TP2	GND	ground
TP3	LDO2	LDO2 regulator output
TP4	LDO1	LDO1 regulator output
TP5	VPRE	VPRE DC-to-DC regulator output
TP6	GND	ground
TP7	VBOOST	VBOOST DC-to-DC output
TP8	BOOST_LS	VBOOST low-side switcher
TP9	BUCK1_SW	BUCK1 switcher
TP10	BUCK1	BUCK1 DC-to-DC regulator output
TP11	BUCK3	BUCK3 DC-to-DC regulator output
TP12	BUCK3_SW	BUCK3 switcher
TP13	BUCK2_SW	BUCK2 switcher
TP14	BUCK2	BUCK2 DC-to-DC regulator output
TP18	GND	ground
TP19	GND	ground
TP20	RSTB	reset
TP21	INTb	interruption
TP22	n.c.	not connected
TP26	PGOOD	power good

4.3.5 Jumpers

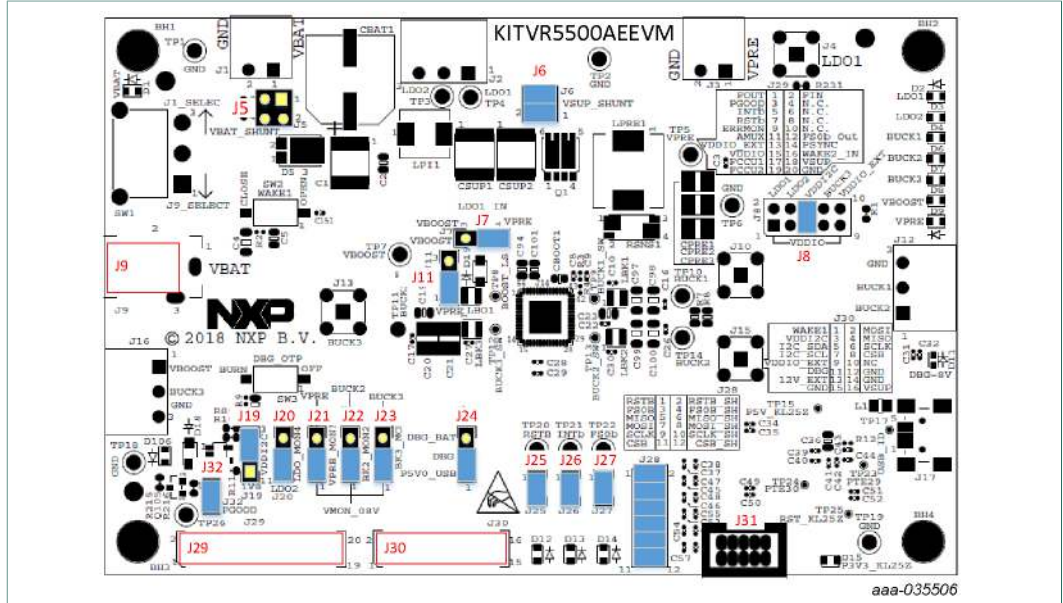

Figure 14. Evaluation board jumper locations

Table 13. Evaluation board jumper descriptions

Name	Function	Pin number	Jumper/pin function
J5	V <sub>BAT</sub> shunt	1-2	shunt switch SW1 for current > 5.0 A
		3-4	shunt switch SW1 for current > 5.0 A
J6	V <sub>SUP</sub> shunt	1-2	for current measurement (insert amperemeter)
		3-4	for current measurement (insert amperemeter)
J7	LDO1 input	1-2	LDO1_IN connected to V <sub>PRE</sub>
		2-3	LDO1_IN connected to VBOOST
J8	VDDIO selection	1-2	VDDIO tied to LDO1
		3-4	VDDIO tied to LDO2
		5-6	VDDIO tied to VDDI2C (provided by external regulators)
		7-8	VDDIO tied to BUCK3
		9-10	VDDIO tied to VDDIO external
J9	V <sub>BAT</sub> Jack	Jack	used for V <sub>BAT</sub> supply using Jack connector
J11	BUCK3 input	1-2	BUCK_INQ tied to V <sub>PRE</sub>
		2-3	BUCK_INQ tied to VBOOST
J19	VDDI2C_SEL	1-2	select 1.8 V output on external regulator
		2-3	select 3.3 V output on external regulator
J20	n.c.	1-2	n.c.
		2-3	n.c.

Name	Function	Pin number	Jumper/pin function
J21	VMON1	1-2	VMON1 tied to 0.8 V
		2-3	VMON1 tied to VPRE
J22	n.c.	1-2	n.c.
		2-3	n.c.
J23	n.c.	1-2	n.c.
		2-3	n.c.
J24	debug	1-2	pin DBG tied to P5V0_USB (5.0 V provided by USB connector)
		2-3	pin DBG tied to V <sub>BAT</sub> (through external protection); do not use for OTP burning
J25	RSTB	1-2	reset LED; enabled when jumper is plugged
J26	INTb	1-2	interrupt LED; enabled when jumper is plugged
J27	n.c.	1-2	n.c.
J29	—	—	—
J30	—	—	—
J31	—	—	use only during board manufacturing
J32	PGOOD	1-2	PGOOD LED; enabled when jumper is plugged

4.3.6 Switches

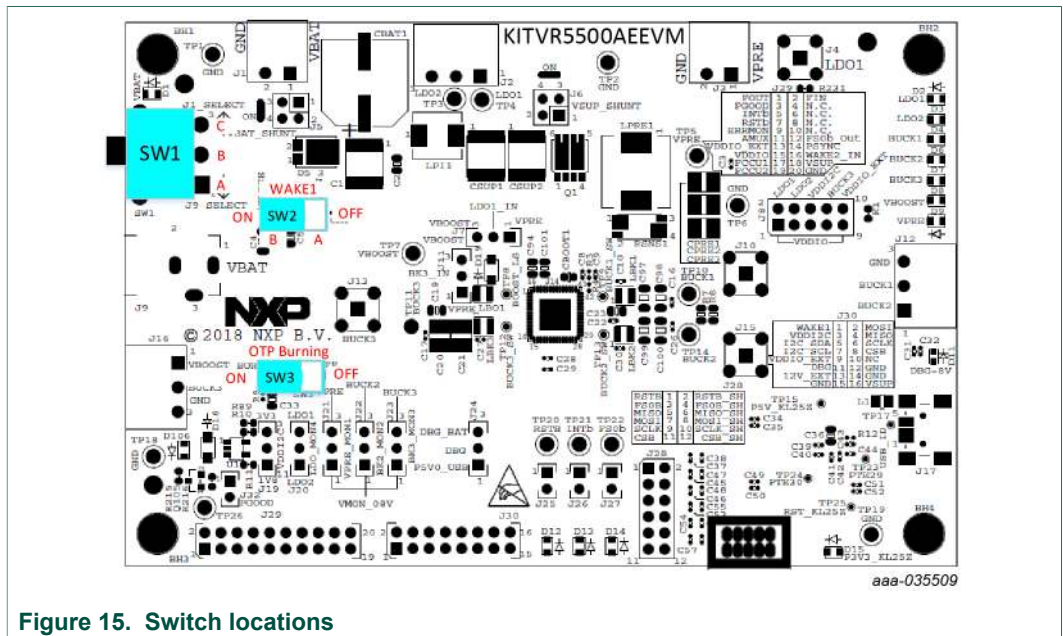

Figure 15. Switch locations

Table 14. SW3

Position	Function	Description
RIGHT	OTP programming off	OTP burning not possible
LEFT	OTP programming on	8.0 V on DBG pin allows OTP burning (blue LED turns on to indicate this state)

Table 15. SW2

Position	Function	Description
OFF	WAKE1 open	WAKE1 pin not connected to $V_{SUP}$
ON	WAKE1 closed	WAKE1 pin connected to $V_{SUP}$

Table 16. SW1

Position	Function	Description
TOP	$V_{BAT}$ on	$V_{BAT}$ from J1
MIDDLE	$V_{BAT}$ off	board not supplied
BOTTOM	$V_{BAT}$ on	$V_{BAT}$ from J9

#### 4.4 Schematic, board layout and bill of materials

The schematic, board layout and bill of materials for the KITVR5500AEEVM evaluation board are available at <http://www.nxp.com/KITVR5500AEEVM>.

## 5 Installing and configuring software and tools

This development kit uses FlexGUI software. FlexGUI software is based on Java JRE.

Preparing the Windows PC workstation consists of three steps.

1. Install the appropriate Java SE Runtime Environment (JRE).
2. Install Windows 7 FlexGUI driver.
3. Install FlexGUI software package.

### 5.1 Installing the Java JRE

1. Download Java JRE (Java SE Runtime Environment), available at <http://www.oracle.com/technetwork/java/javase/downloads/jre8-downloads-2133155.html> (8u162 or newer).
2. Open the installer and follow the installation instructions.
3. Following the successful installation, restart the computer.

### 5.2 Installing Windows 7 FlexGUI driver

On Windows 7 PCs, a virtual COM port installation is required. Install the Windows 7 FlexGUI driver using the following procedure.

**Note:** On Windows 10, it is not necessary to install virtual com port as Windows 10 uses a generic COM port driver.

1. Connect the kit to the computer as described in [Section 6](#)
2. On the Windows PC, open the **Device Manager**.
3. In the **Device Manager** window, right-click on **SECON FLEX GUI SLAVE**, and then select **Properties**.

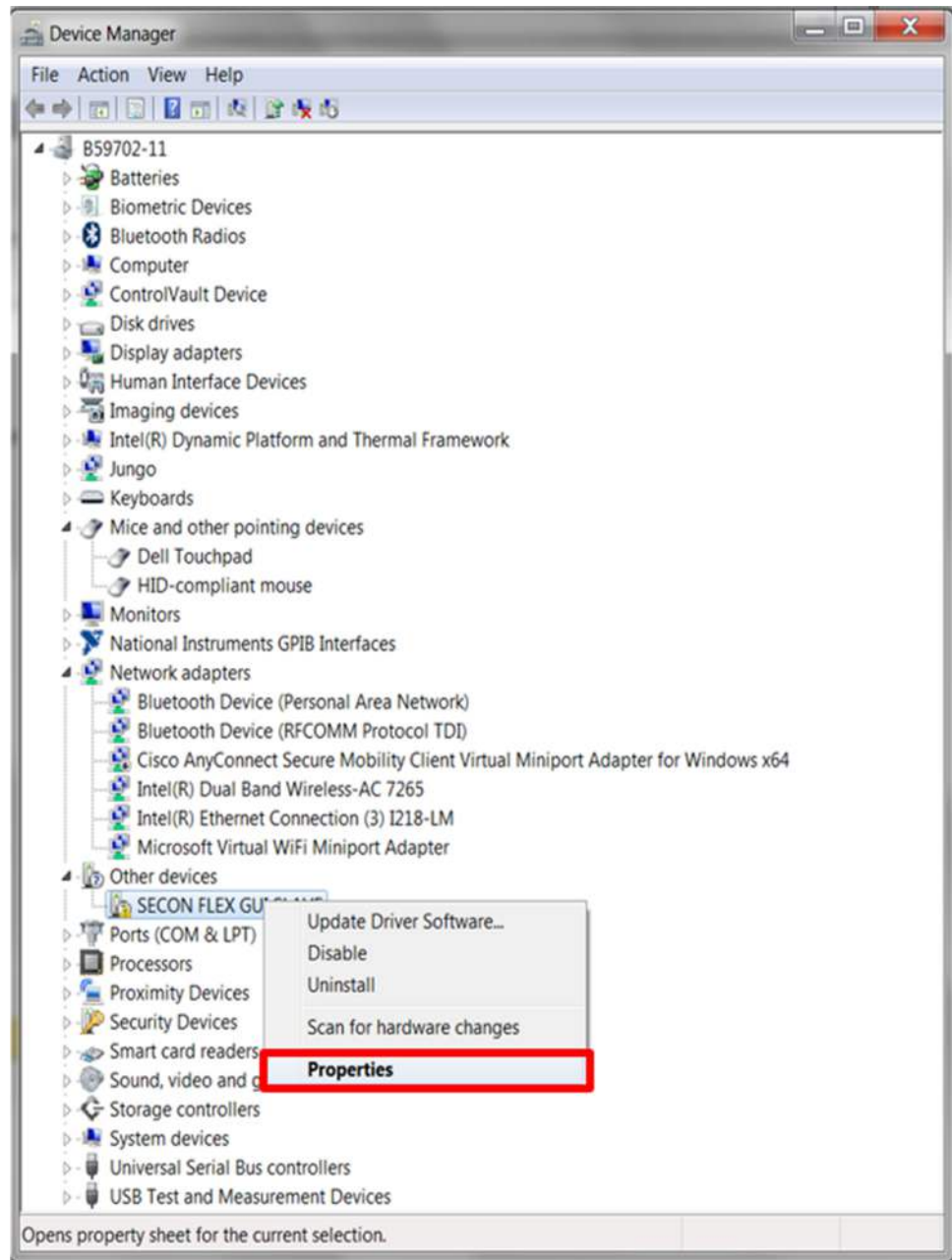

aaa-031982

4. In the **SECON FLEX GUI SLAVE Properties** window, click **Update Driver**.

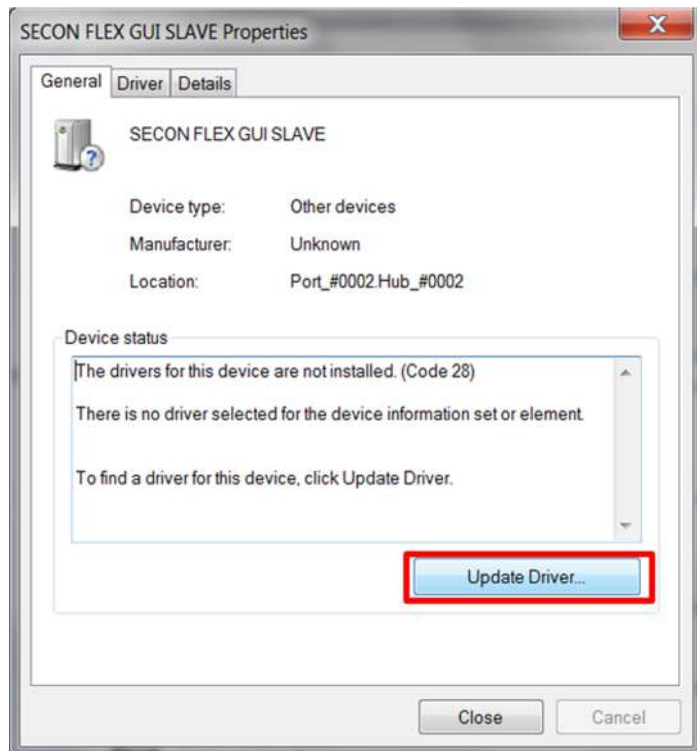

aaa-031983

5. in the **Update Software Driver** window, select **Browse my computer for driver software**.

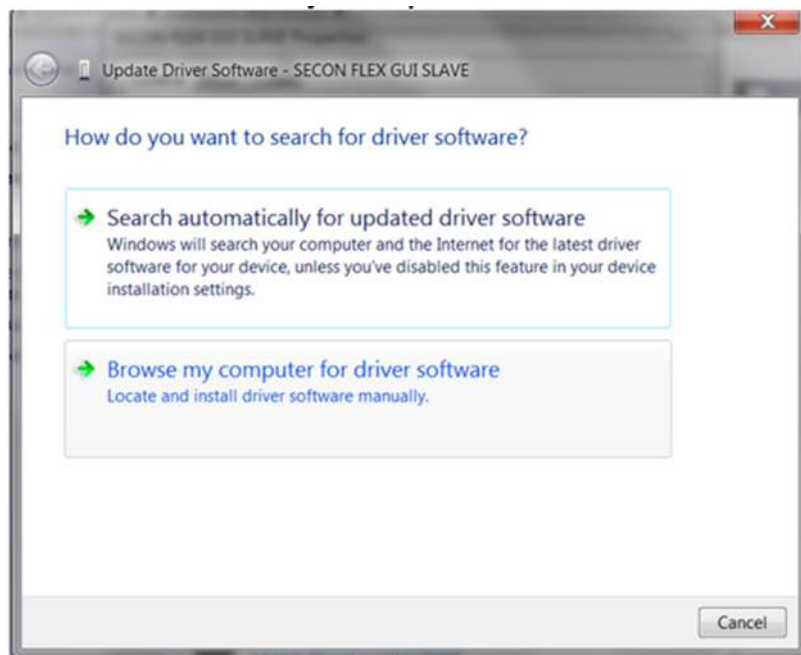

aaa-031984

6. Select **Let me pick from a list of device drivers on my computer**, and then click **Next**.

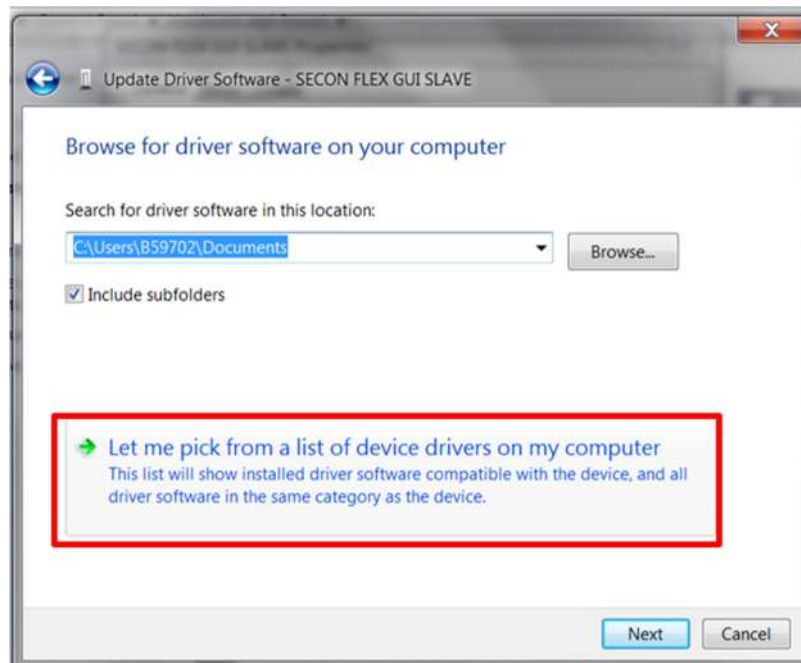

aaa-031985

7. Select **Ports (COM & LPT)** from the list, and then click **Next**.

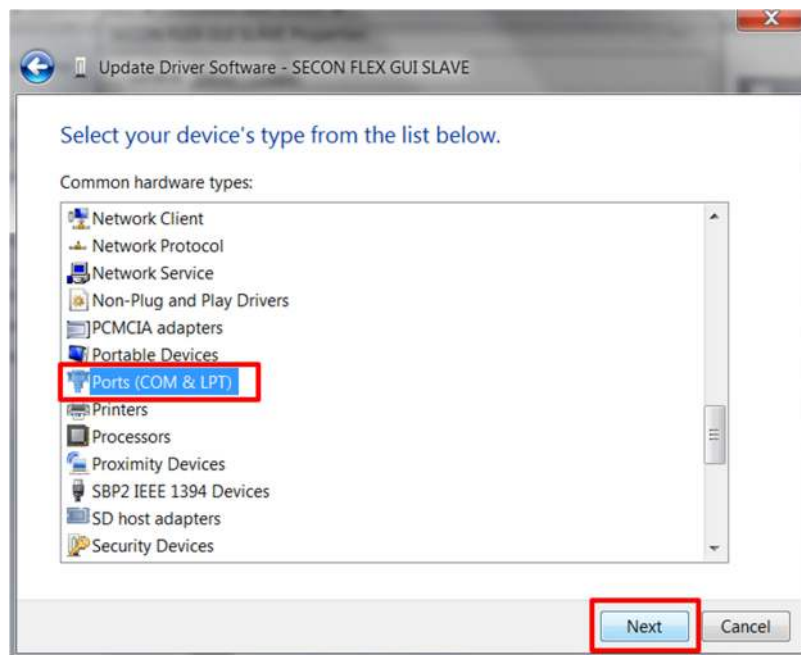

aaa-031986

8. Click **Have Disk**.

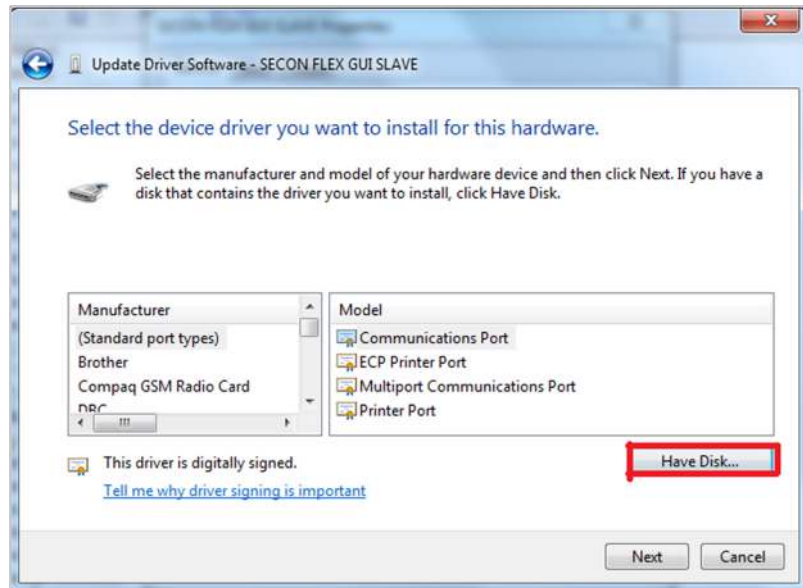

aaa-031987

9. Click **Browse**.

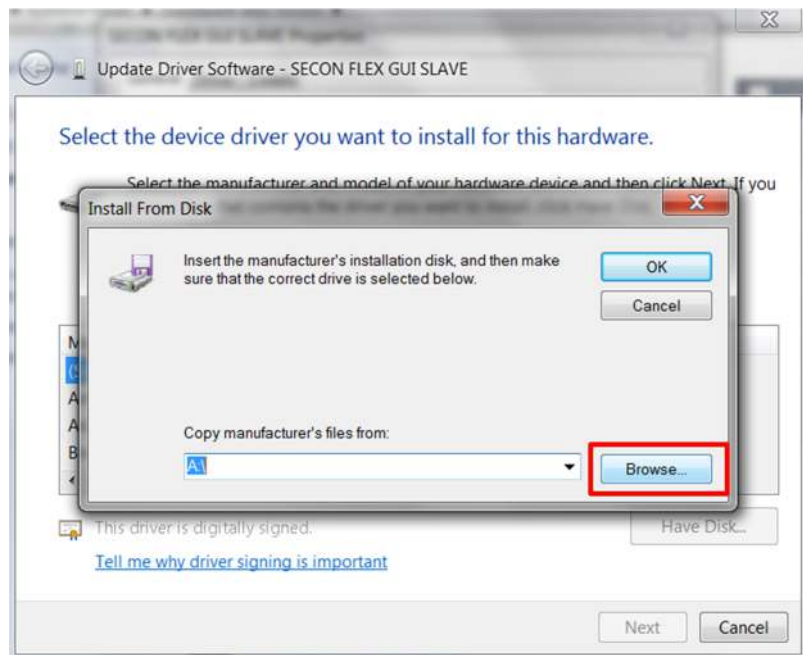

aaa-031988

10. In the **Locate File** window, locate and select **fsl\_ucwxp**, and then click **Open**.



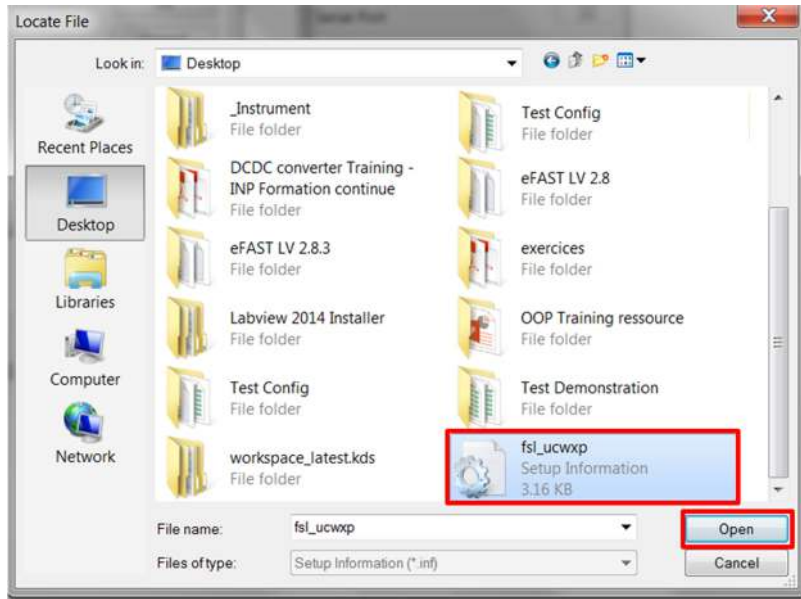

aaa-031989

11. In the **Install from Disk** window, click **OK**.

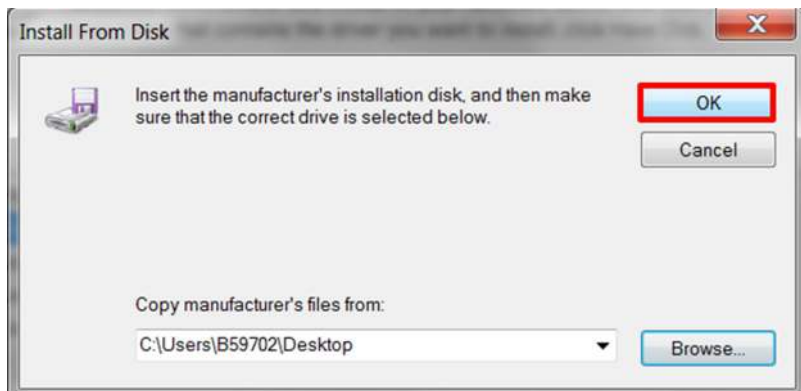

aaa-031990

12. If prompted, in the **Windows Security** window, click **Select this driver software anyway**.

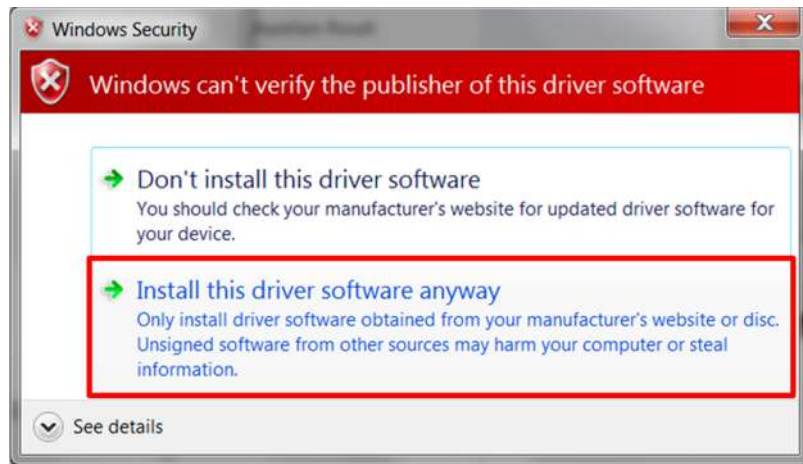

aaa-031991

13. Close the window when the installation is complete.

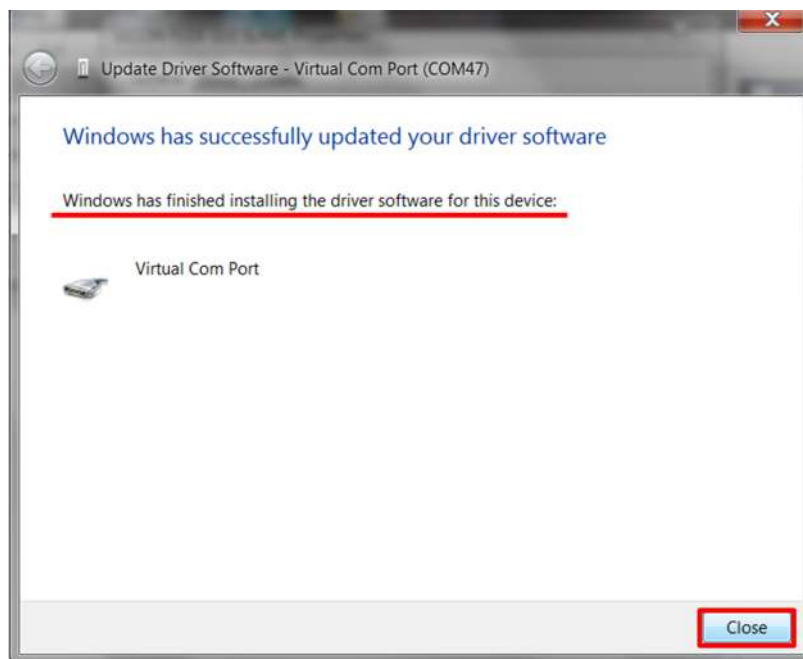

aaa-031992

14. In the **Virtual Com Port Properties** window, verify that the device is working properly, and then click **Close**.

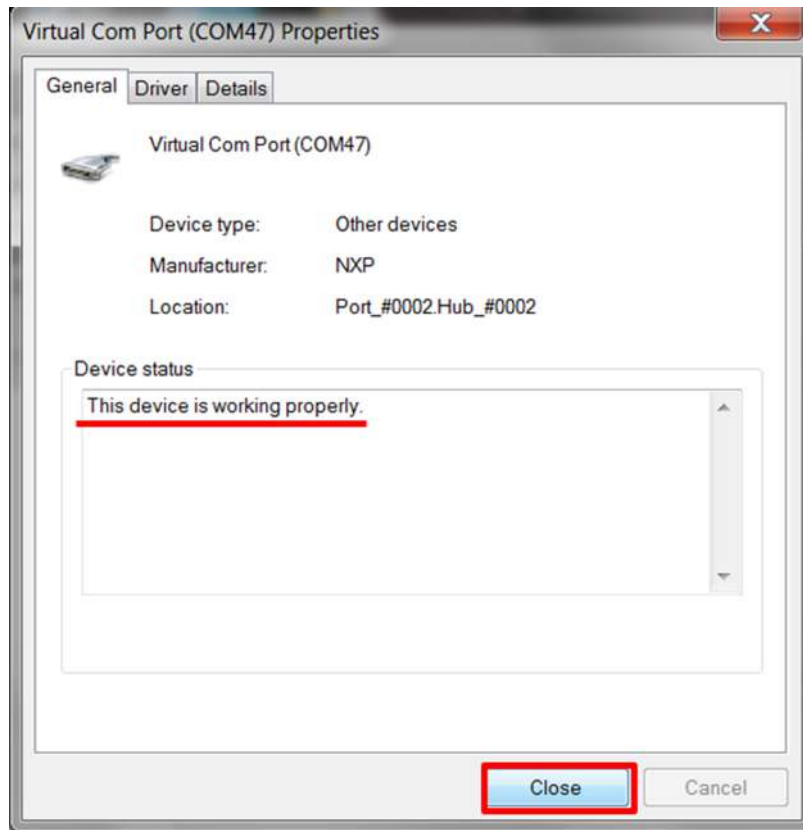

aaa-031993

The Virtual Com Port appears in the Device Manager window.

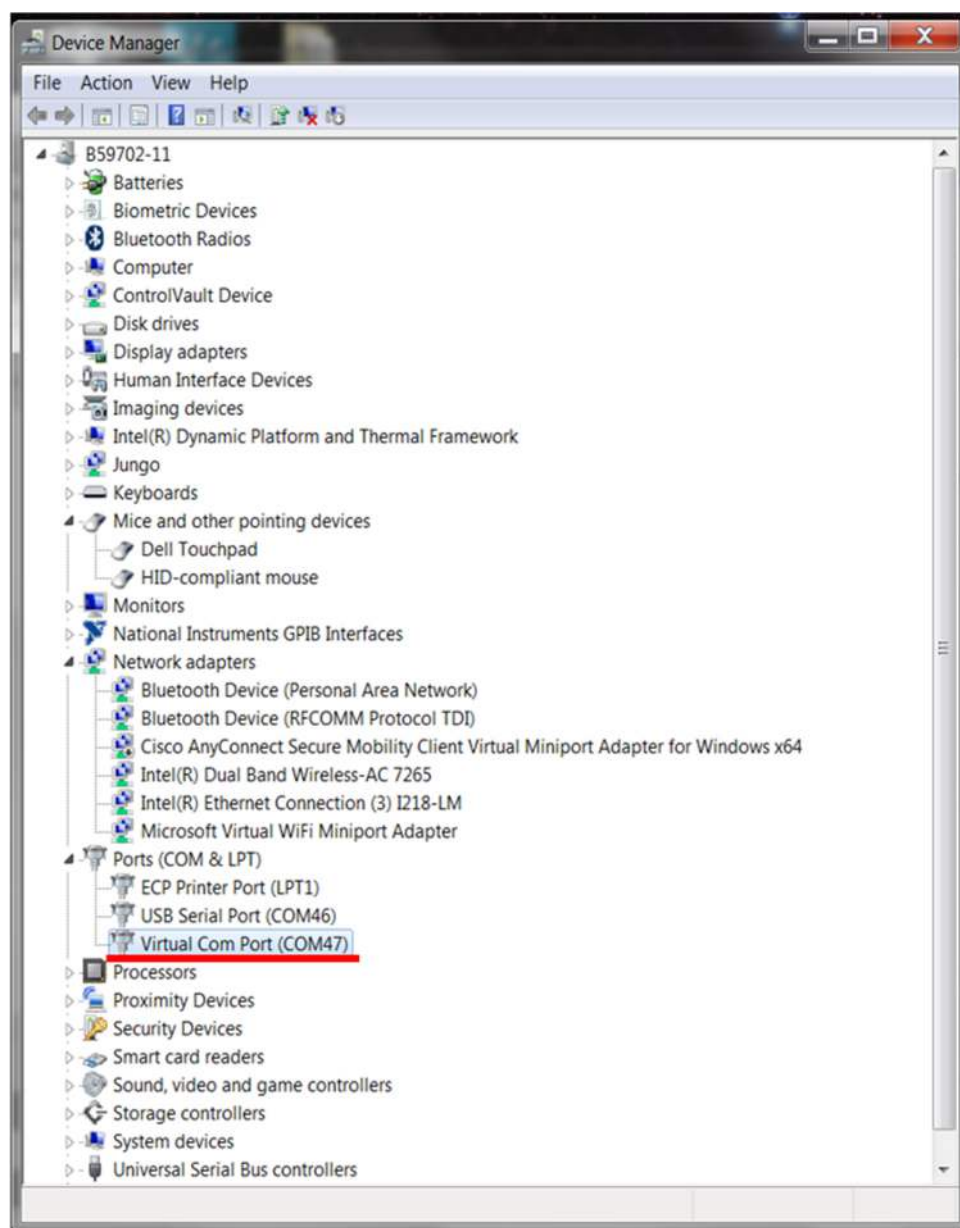

aaa-031994

### 5.3 Installing FlexGUI software package

The FlexGUI software installation requires only extracting the zip file in a desired location.

1. If necessary, install the Java JRE and Windows 7 FlexGUI driver.
2. Download the latest FlexGUI (32-bit or 64-bit) version, available at <http://www.nxp.com/KITVR5500AEEVM>.
3. Run the flexgui-app-vr5500-fs5502.exe, install the FlexGUI with step by step guidance.

## 6 Configuring the hardware for startup

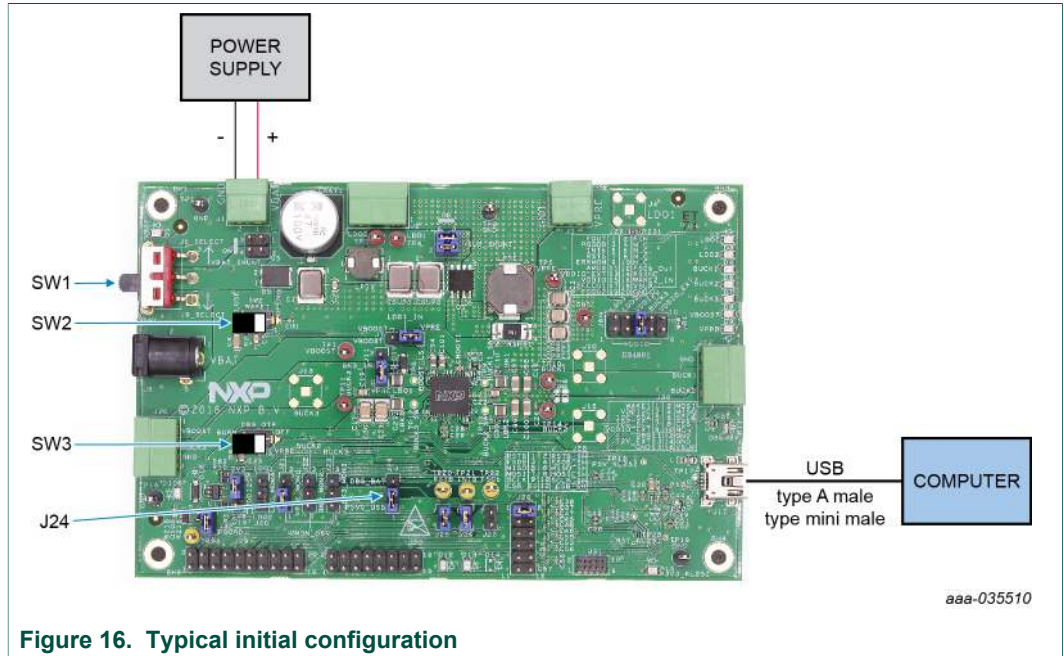

Figure 16. Typical initial configuration

Figure 16 presents a typical hardware configuration incorporating the development board, power supply, and Windows PC workstation.

To configure the hardware and workstation as illustrated in Figure 16, complete the following procedure:

1. Install jumpers for the configuration.

Table 17. Jumper configuration

Jumper	Configuration
J24	connect 1-2 (connect 5.0 V on DBG pin from the USB)

2. Configure switches for the configuration

Table 18. Switch configuration

Switch	Configuration
SW1	middle position (VBAT off)
SW2	open (WAKE1)
SW3	open (OTP programming off)

3. Connect the Windows PC USB port to the KITVR5500AEEVM development board using the provided USB 2.0 cable.  
Set the DC power supply to 12 V and current limit to 1.0 A. With power turned off, attach the DC power supply positive and negative output to KITVR5500AEEVM V<sub>BAT</sub> Phoenix connector (J1).
4. Turn on the power supply.
5. Close SW2.

**Note:** At this step, the product is in debug mode and all regulators are turned off. The user can then power up with OTP configuration or configure the mirror registers before power up. Power up is effective as soon as J24 jumper is removed.

## 7 Using the KITVR5500AEEVM evaluation board

This section summarizes the overall setup. Detailed description is provided in the following sections.

Before starting the process, choose the mode you want to run the device.

- In Normal mode, the configuration comes from OTP fuses.
- In Debug mode, you can either use the current configuration from OTP fuse, if any, or use the OTP emulation mode to write in the mirror register.

The Normal mode or Debug mode is defined at startup depending on the DBG pin level.

- Normal mode is set by tying DBG to ground
- Debug mode is set by setting DBG voltage to 5.0 V

In OTP emulation, you can overwrite the mirror registers from a given OTP fuse configuration. See [Section 4.2.1](#) and [Section 8.3](#) to define your configuration.

In OTP fuse configuration, use the configuration fused in the OTP. So, if a valid OTP fuse configuration exists, then it is copied to the mirror registers at startup.

### 7.1 Generating the OTP configuration file

Define and generate your OTP configuration using the excel file *VR5500\_OTP\_Config.xlsm* or *FS5502\_OTP\_Config.xlsm*. This file allows configuring the device for parameters controlled by the main state machine and the fail-safe state machine.

To generate the script:

1. Fill the **OTP\_conf\_main\_reg** sheet

MAIN OTP_REGISTERS												
Register Name	ADDRESS	BIT7	BIT6	BIT5	BIT4	BIT3	BIT2	BIT1	BIT0	Data_Bin	Data_Hex	
OTP_CFG_VPRE	14	-	-	-	-	-	VPREV[5:0]	-	-	00011 - 3.3V	00001111	0x0F
OTP_CFG_VPRE	15	0	0	-	-	-	VPRES[5:0]	-	-	00110 - 140mV/us	00001110	0x0E
OTP_CFG_VPRE	16	-	-	-	-	-	VPRESLS[1:0]	-	-	00 - PUPD/130mA	11101100	0x1C
OTP_CFG_BOOST	17	-	-	-	-	-	VPRETOFF[1:0]	-	-	11 - 150mV	00001101	0x0D
OTP_CFG_BOOST	18	-	-	-	-	-	VPRETOFF[1:0]	-	-	00 - 40ns	10011110	0x1E
OTP_CFG_BOOST	19	-	-	-	-	-	VPRETOFF[1:0]	-	-	00 - 60ns	00001111	0x07
OTP_CFG_BUCK1	1A	-	-	-	-	-	VPRETOFF[1:0]	-	-	00 - 750ohms	10001000	0x18
OTP_CFG_BUCK1	1B	-	-	-	-	-	VPRETOFF[1:0]	-	-	00 - 125pF	00000110	0x06
OTP_CFG_BUCK2	1C	-	-	-	-	-	VPRETOFF[1:0]	-	-	000 - 1.8V	10110001	0x11
OTP_CFG_BUCK2	1D	-	-	-	-	-	VPRETOFF[1:0]	-	-	00 - 1uH	00011000	0x14
OTP_CFG_BUCK3	1E	-	-	-	-	-	VPRETOFF[1:0]	-	-	00 - 1uH	10001110	0x1E
OTP_CFG_BUCK3	1F	-	-	-	-	-	VPRETOFF[1:0]	-	-	00 - 1uH	01010011	0x13
OTP_CFG_LDO	20	-	-	-	-	-	VPRETOFF[1:0]	-	-	010 - 32.5GM	01101110	0x16
OTP_CFG_SEQ 1	21	-	-	-	-	-	VPRETOFF[1:0]	-	-	000 - 400mA	00001010	0x0A
OTP_CFG_SEQ 2	22	-	-	-	-	-	VPRETOFF[1:0]	-	-	000 - 400mA	00111011	0x13
OTP_CFG_SEQ 3	23	-	-	-	-	-	VPRETOFF[1:0]	-	-	000 - 400mA	00000000	0x00
OTP_CFG_CLOCK	24	-	-	-	-	-	VPRETOFF[1:0]	-	-	001 - Regulator Start and Stop in Slot 1	00000100	0x04
OTP_CFG_CLOCK	25	-	-	-	-	-	VPRETOFF[1:0]	-	-	010 - Regulator Start and Stop in Slot 2	00110011	0x13
OTP_CFG_CLOCK	26	-	-	-	-	-	VPRETOFF[1:0]	-	-	011 - Regulator Start and Stop in Slot 3	00000000	0x00
OTP_CFG_CLOCK	27	-	-	-	-	-	VPRETOFF[1:0]	-	-	000 - Regulator Start and Stop in Slot 0	00001010	0x0A
OTP_CFG_SM 1	28	-	-	-	-	-	VPRETOFF[1:0]	-	-	0 - CLK1	00000000	0x00
OTP_CFG_SM 2	29	-	-	-	-	-	VPRETOFF[1:0]	-	-	0 - BOOST Shutdown	00001100	0x0C
OTP_CFG_VSUP U	2A	-	-	-	-	-	VPRETOFF[1:0]	-	-	0 - 250us	00000000	0x00
OTP_CFG_I2C	2B	-	-	-	-	-	VPRETOFF[1:0]	-	-	0 - 250us	00000000	0x00
OTP_CFG_OV	2C	-	-	-	-	-	VPRETOFF[1:0]	-	-	0 - 250us	00000001	0x01
OTP_CFG_DEVID	2D	-	-	-	-	-	VPRETOFF[1:0]	-	-	0 - 250us	00000001	0x01
OTP_M_S1_CRC_LSR	2E	-	-	-	-	-	VPRETOFF[1:0]	-	-	0 - 250us	00000000	0x00
OTP_M_S1_CRC_MSB	2F	-	-	-	-	-	VPRETOFF[1:0]	-	-	0 - 250us	00000000	0x00

aaa-035261

Figure 17. OTP\_conf\_main\_reg spreadsheet example

2. Fill the OTP\_conf\_failsafe\_reg sheet

FAIL-SAFE OTP_REGISTERS											
Register Name	ADDRESS	R117	R116	R115	R114	R113	R112	R111	R110	Data_Bin	Data_Hex
OTP_CFG_VPRE	14	-	-	-	-	-	-	-	-	00001000	0x18
OTP_CFG_VPRE	15	-	-	-	-	-	-	-	-	00110011	0x13
OTP_CFG_VPRE	16	-	-	-	-	-	-	-	-	00000000	0x00
OTP_CFG_BOOST	17	-	-	-	-	-	-	-	-	01111	0x0F
OTP_CFG_BOOST	18	-	-	-	-	-	-	-	-	00	0x00
OTP_CFG_BOOST	19	-	-	-	-	-	-	-	-	00110100	0x16
OTP_CFG_BUCK1	1A	-	-	-	-	-	-	-	-	00011	0x03
OTP_CFG_BUCK1	1B	-	-	-	-	-	-	-	-	00	0x00
OTP_CFG_BUCK2	1C	-	-	-	-	-	-	-	-	00011	0x03
OTP_CFG_BUCK2	1D	-	-	-	-	-	-	-	-	00	0x00
OTP_CFG_BUCK3	1E	-	-	-	-	-	-	-	-	01000111	0x17
OTP_CFG_BUCK3	1F	-	-	-	-	-	-	-	-	00000111	0x07
OTP_CFG_LDO	20	-	-	-	-	-	-	-	-	10000000	0x10
OTP_CFG_SEQ 1	21	-	-	-	-	-	-	-	-	00000000	0x00
OTP_CFG_SEQ 2	22	-	-	-	-	-	-	-	-	00101101	0x1D
OTP_CFG_SEQ 3	23	-	-	-	-	-	-	-	-	00000101	0x05
OTP_CFG_CLOCK	24	-	-	-	-	-	-	-	-	00000000	0x00
OTP_CFG_CLOCK	25	-	-	-	-	-	-	-	-	00000000	0x00
OTP_CFG_CLOCK	26	-	-	-	-	-	-	-	-	00000000	0x00
OTP_CFG_CLOCK	27	-	-	-	-	-	-	-	-	00000000	0x00
OTP_CFG_SM 1	28	-	-	-	-	-	-	-	-	00000000	0x00
OTP_CFG_SM 2	29	-	-	-	-	-	-	-	-	00000000	0x00
OTP_CFG_VSUP U	2A	-	-	-	-	-	-	-	-	00000000	0x00
OTP_CFG_I2C	2B	-	-	-	-	-	-	-	-	00000000	0x00
OTP_CFG_OV	2C	-	-	-	-	-	-	-	-	00000000	0x00
OTP_CFG_DEVID	2D	-	-	-	-	-	-	-	-	00000000	0x00
OTP_M_S1_CRC_LSR	2E	-	-	-	-	-	-	-	-	00000000	0x00
OTP_M_S1_CRC_MSB	2F	-	-	-	-	-	-	-	-	00000000	0x00

aaa-035511

Figure 18. OTP\_conf\_failsafe\_reg spreadsheet example

3. See the OTP\_conf\_summary sheet to review the complete configuration (main and fail-safe)

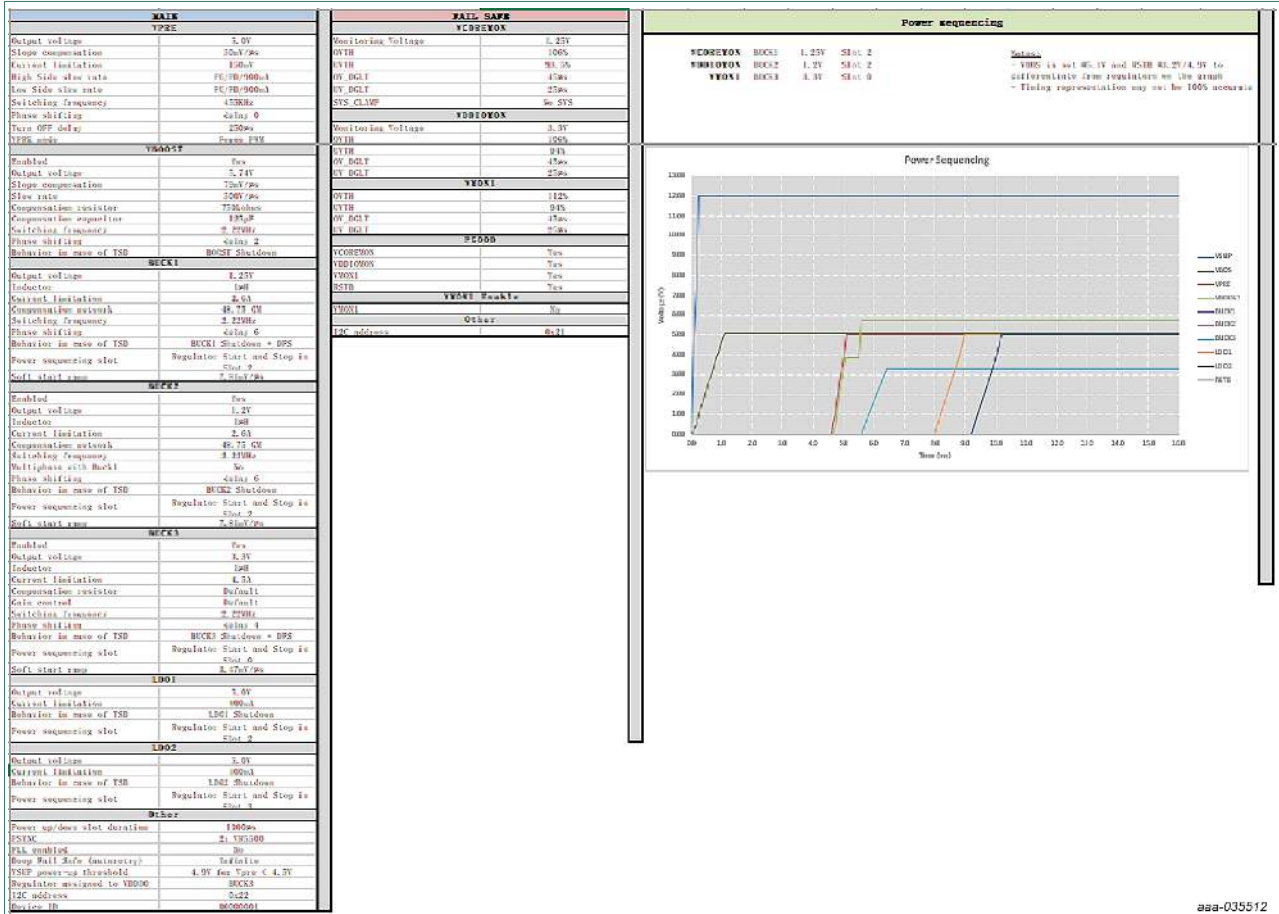

Figure 19. OTP\_conf\_summary example

- Generate the script in **OTP\_conf\_file\_generation** sheet
- Once the configuration is ready, the user can generate the script file. Go to **OTP\_conf\_file\_generation**, enter the path in the **File repository**, and then click **Write\_OTP\_File\_GUI**.

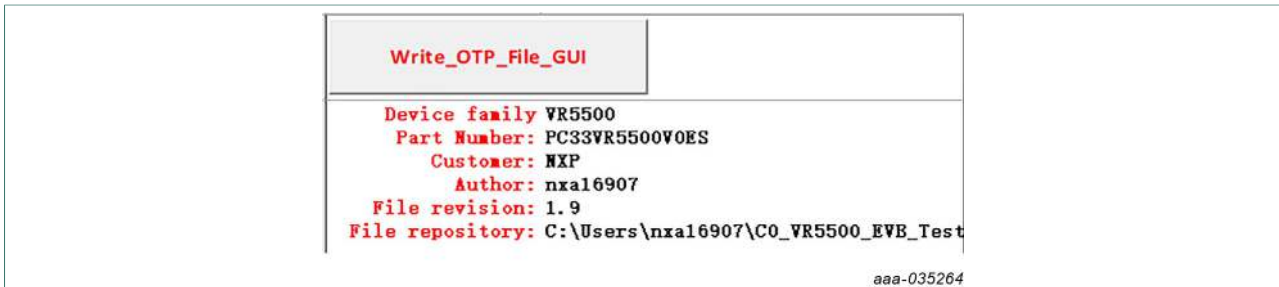

Figure 20. OTP script generation



## 7.2 Working in OTP emulation mode

At startup, the device always uses the content from the mirror register. This content can come from OTP fuse or from configuration written directly in the mirror register. OTP emulation means that the user can emulate the OTP writing in the mirror register. It allows trials before burning the OTP.

1. Configure the hardware; see [Section 6](#).
2. Launch the FlexGUI software.
3. Switch to Debug mode:
  - a. Place SW1 in TOP direction ( $V_{BAT}$  switched on).
  - b. Close SW2 (WAKE1).While in Debug mode, all regulators are turned off.
4. Load the mirror registers to work in OTP emulation mode; see [Section 8.3](#).
5. Unplug jumper J24 1-2 to start the device with the mirror configuration setting.
  - a. If the mirror registers are filled (with a configuration using the Script editor), that configuration is used in the emulation session.
  - b. If the mirror registers are not filled (with a configuration using the Script editor), the currently programmed OTP fuse configuration is used, if it exists.
  - c. Otherwise, the mirror registers are not filled and the OTP fuse is not burned, and the device does not start up.
6. Use the FlexGUI software to evaluate the device configured; see [Section 8](#).

## 7.3 Programming the device with an OTP configuration

The device configuration can be changed three times (see [Section 4.2.1](#)). The programming steps are the same as the OTP emulation mode up to step 6.

Then, the user has to burn the part with FlexGUI; see [Section 8.4.7](#). Follow the instructions on the screen to proceed.

# 8 Using FlexGUI

To follow the steps in this section, make sure that the board is connected using the appropriate hardware configuration (see [Section 7.2](#)).

**Note:** *It is recommended to use the latest version of FlexGUI.*

## 8.1 Starting the FlexGUI application

After launching the FlexGUI, the FlexGUI launcher displays available kits.

Select I<sup>2</sup>C-bus as communication bus on the launcher page for VR5500/FS5502.

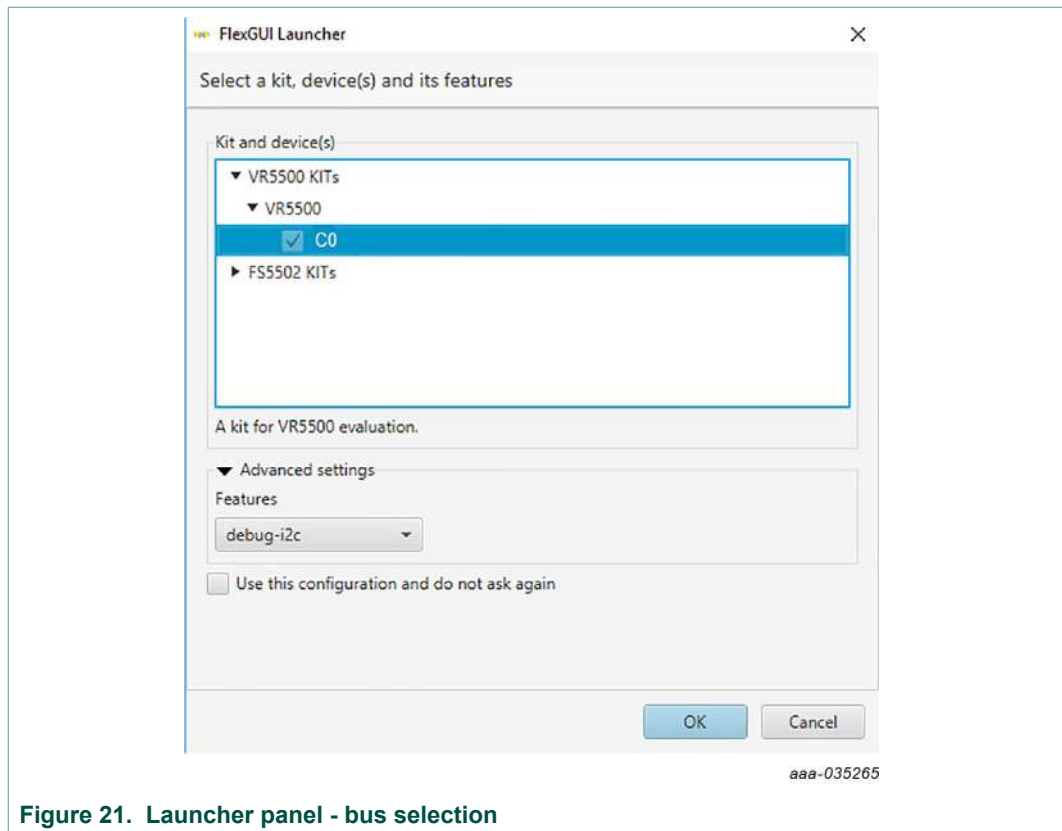

Figure 21. Launcher panel - bus selection

When the configuration is selected, click **OK**.

## 8.2 Establishing the connection between FlexGUI and the hardware

The board must be connected to the USB before establishing a connection.

- Click **Search** to detect the COM port of the board.
- Click **Start** to enable the connection.

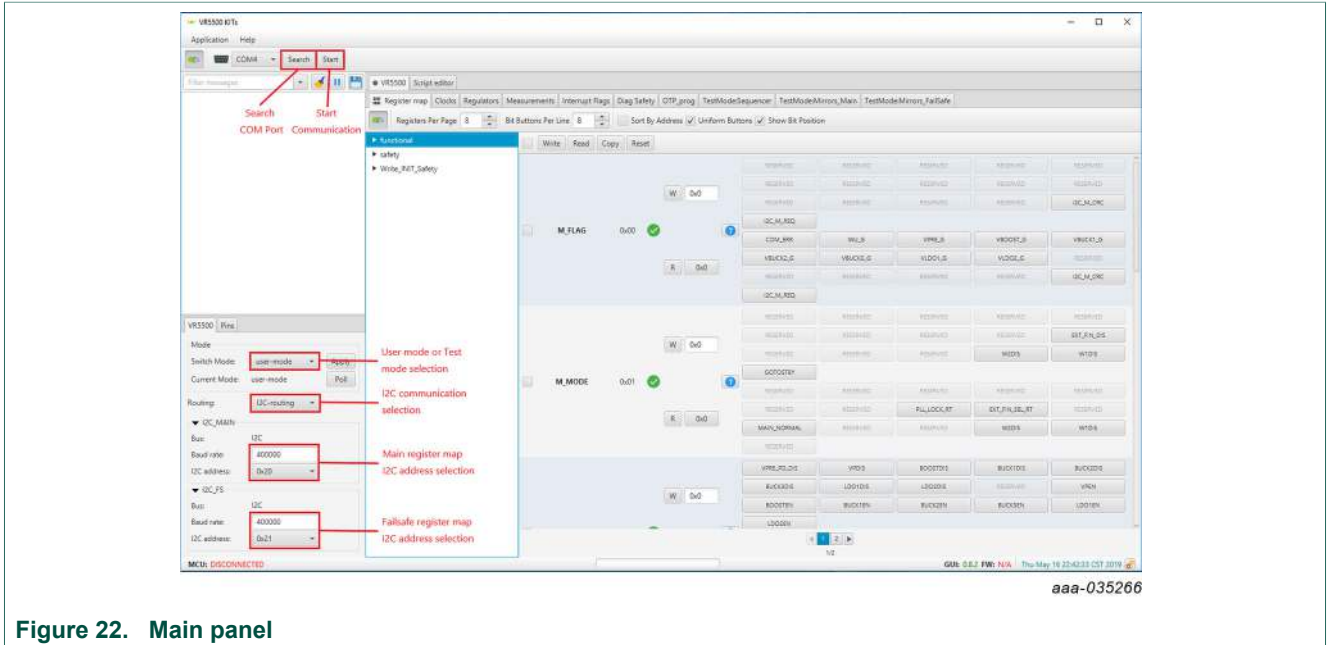

Figure 22. Main panel

Figure 22 shows the mode selection. At first launch, the FlexGUI starts in User mode. The user can then decide to switch to Test mode using the Switch mode drop-down list followed by clicking **Apply**.

The **GUI-Device Status** field checks the connection from MCU to the device. The **ONLINE** status indicates a good connection, while **ERROR** status indicates an issue (for example  $V_{SUP}$  is not provided to the device).

Select I<sup>2</sup>C-bus as communication bus.

It is also possible to change the clock frequency using this panel.

Note that in the case of I<sup>2</sup>C-bus, most of the time, the default address used by the device are 0x20 for main and 0x21 for the fail-safe.

The I<sup>2</sup>C-bus address is managed differently in Debug and Normal mode

- Debug mode:
  - I<sup>2</sup>C-bus address when debug mode pin is set to 5.0 V is 0x20 for main and 0x21 for fail-safe.
  - The user can change this address in the mirror register. The new address is taken into account only after debug pin is released to 0 V.
- Normal mode:
  - The address is burned in the OTP.

The user can read in which mode the device is operating. It is also possible to switch from User mode to Test mode (and the opposite way).

The current operating mode is refreshed periodically by default at FlexGUI startup. This automatic refresh can be disabled by disabling Poll button as shown in Figure 23.

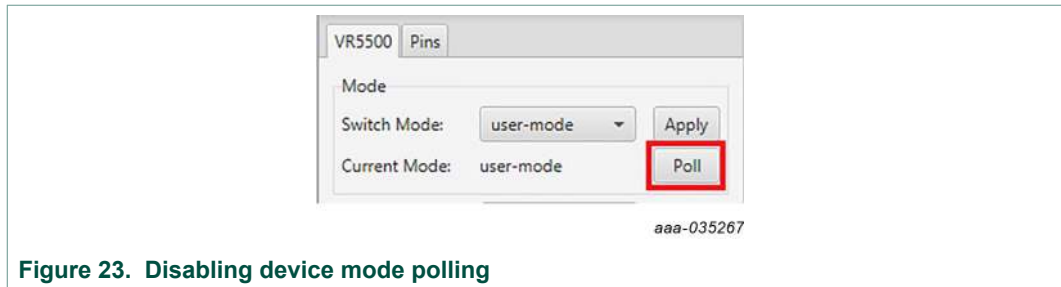

Figure 23. Disabling device mode polling

To move from one mode to the other, select the mode with switch mode drop-down button and click **Apply** to validate. Now, the current mode is updated at the condition that Poll button is enabled.

### 8.3 Working with the script editor

The register and OTP emulation can be configured with the script editor. It is useful to try various OTP configurations in Emulation mode.

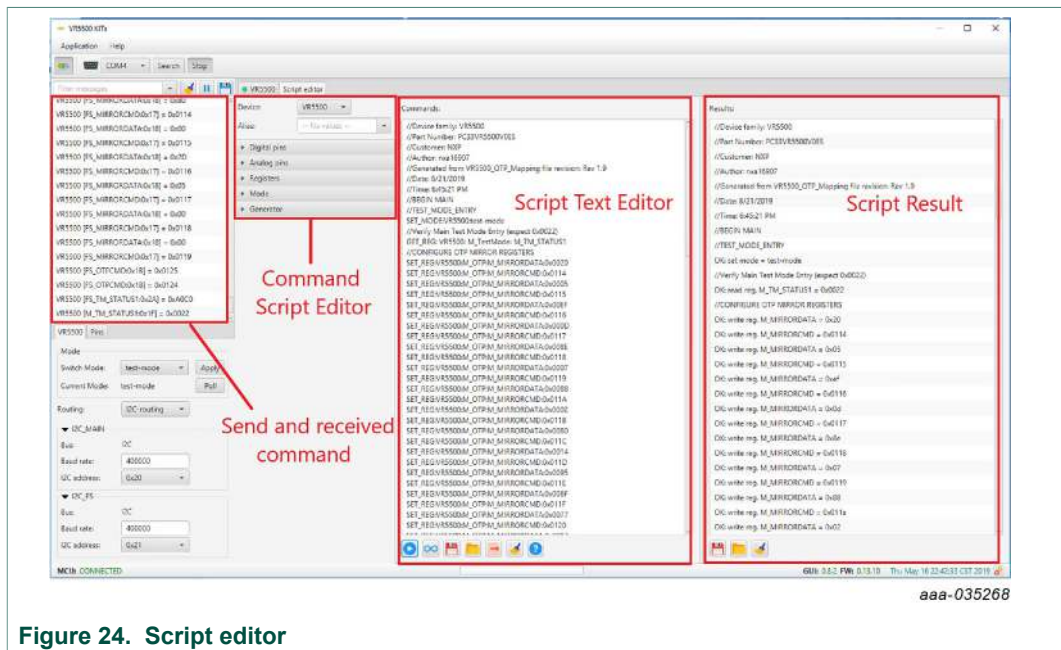

Figure 24. Script editor

The main subareas of this panel are:

- **Send and receive command:** displays a summary of commands sent and received from the device
- **Command script editor:** builds commands to be sent to the device
- **Script text editor:** sends a sequence of register configurations from a text file or from command edited directly in this area
- **Script results:** displays result status of each command sent to the device

#### 8.3.1 Script text editor

Using script editor, you can execute any command either directly or from a file. It is also possible to save and modify a script. Using the brush symbol, it is possible to clean windows if needed.

All commands have to follow a specific syntax. The Help menu describes commands available in the script editor and their syntax.

This help page describes commands available in the script editor and their format.

### List of commands

- **SET\_REG**: sets value of a selected register.
- **READ\_REG**: reads value of a selected register.
- **SET\_DPIN**: sets value of a selected digital pin.
- **GET\_DPIN**: gets value of a selected digital pin.
- **GET\_APIN**: gets value of a selected analog pin. Returned value is in mV.
- **PAUSE**: shows a dialog with user defined message. The script is paused until the user confirms the dialog.
- **EXIT**: stops execution of the script.
- **SET\_MODE**: sets device mode. List of modes depends on a device.

### Command format

The following table describes command parameters. All parameters are mandatory.

	1st parameter	2nd parameter	3rd parameter	4th parameter	5th parameter
SET_REG	Device	Reg. set	Reg. name / Reg. address	Reg. value	-
GET_REG	Device	Reg. set	Reg. name / Reg. address	-	-
SET_DPIN	Device	Pin name	Dig. pin value	-	-
GET_DPIN	Device	Pin name	-	-	-
GET_APIN	Device	Pin name	-	-	-
PAUSE	Message	-	-	-	-
EXIT	-	-	-	-	-

Description of command parameters mentioned in the table above:

- **Device**: device name (alias used in application).
- **Reg. set**: register set name. Register sets allows to associate registers which have similar function.
- **Reg. name**: register name as defined in datasheet.
- **Reg. address**: register address in decimal or hexadecimal (with 0x prefix) format.
- **Reg. value**: register value in decimal or hexadecimal (with 0x prefix) format.
- **Pin name**: name of digital or analog pin as defined in device datasheet.
- **Dig. pin value**: value of digital pin. Allowed strings are 'low' and 'high'.
- **Message**: a message to be displayed in a dialog. It cannot contain '.' character, which is used as delimiter of parameters.
- **Mode**: name of a device mode.

Figure 25 shows an example to build a command from the panel.

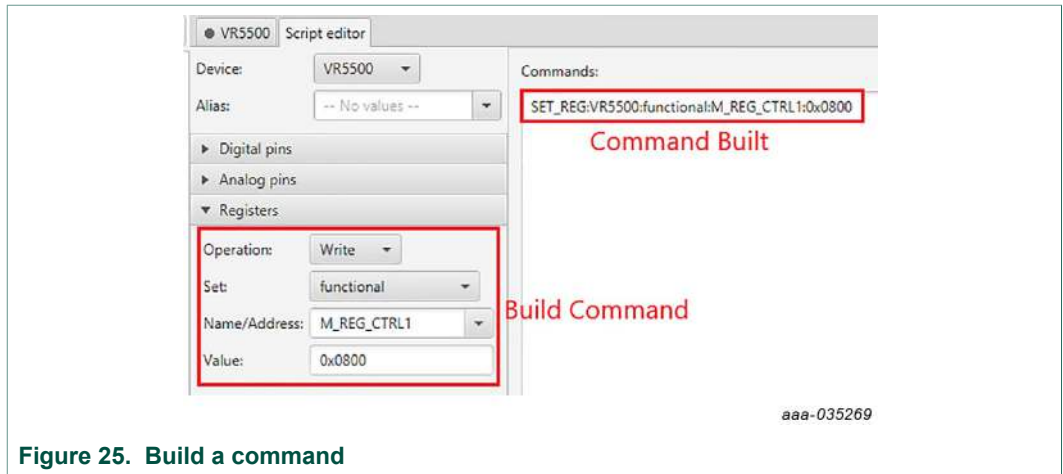

Figure 25. Build a command

The value 0x0800 is sent to the register M\_REG\_CTRL1 (BUCK2DIS). The user can then send it to the device by clicking the arrow; see Figure 26.

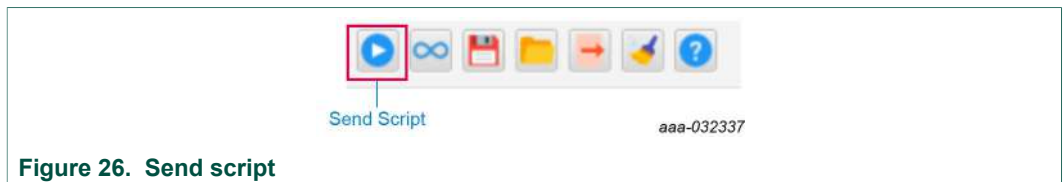

Figure 26. Send script

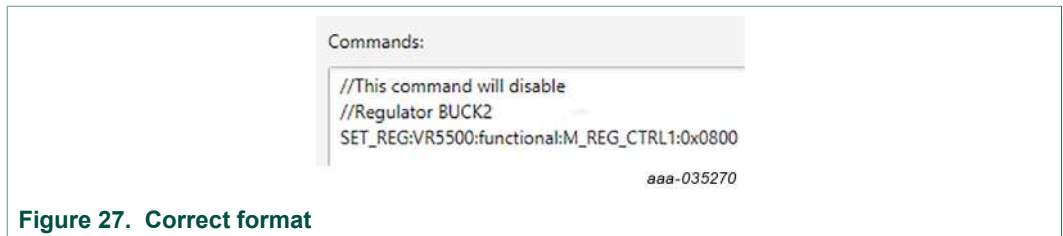

Figure 27. Correct format

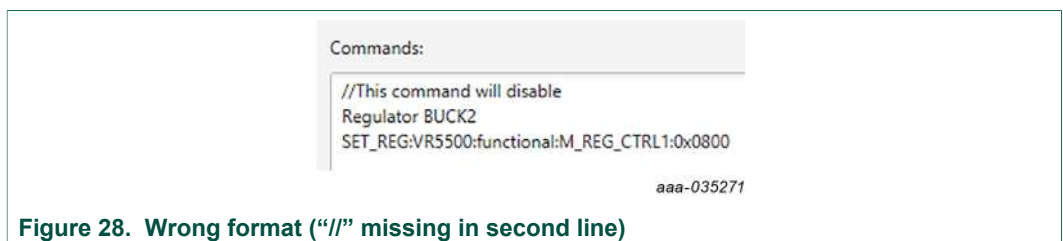

Figure 28. Wrong format (“//” missing in second line)

### 8.4 Understanding the VR5500/FS5502 workspace

The VR5500/FS5502 workspace consists of several tabs, each dedicated to a specific aspect of device functionality or configuration.

- Register map
- Clocks
- Regulators
- Measurements
- Interrupt flags
- Diag safety
- OTP programming
- TestMode:Sequencer
- TestMode:Mirrors\_Main and TestMode:Mirrors\_FailSafe

#### 8.4.1 Register map

All I<sup>2</sup>C-bus registers can be accessed in write and read mode using this tab.

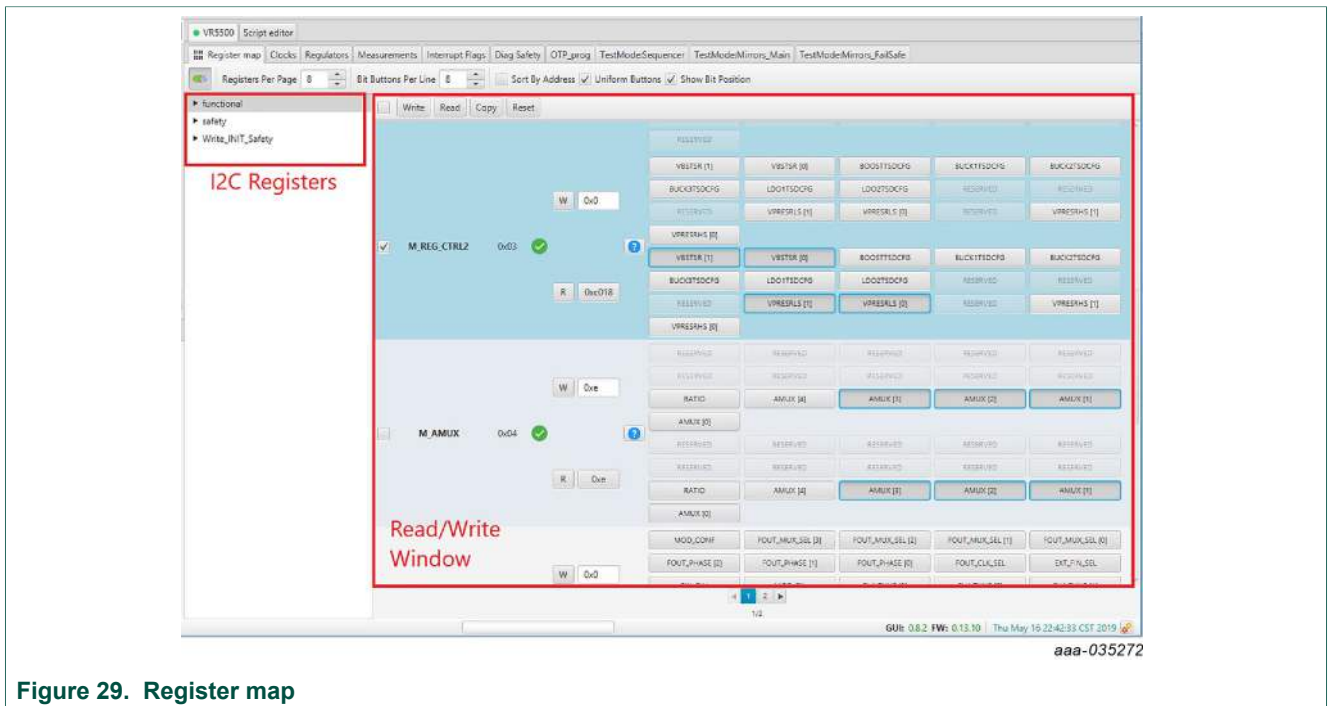

Figure 29. Register map

- **Register map:** allows access to functional register, safety register, and write init register which are accessible only during initialization phase
- **Read/write:** allows you to read/write any register either individually or by bank

8.4.2 Clocks

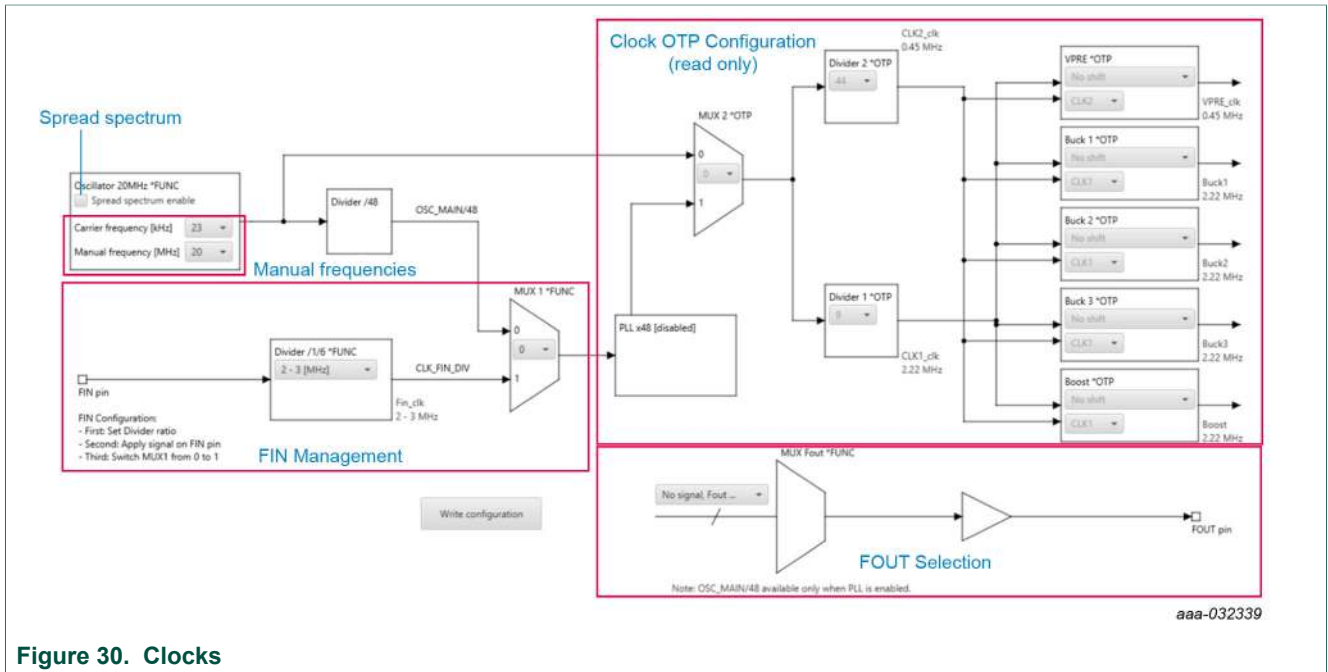

Figure 30. Clocks

This tab allows:

OTP:

- Read current OTP configuration (write operation is not possible). To display the accurate data, the device must operate in Test mode.

I<sup>2</sup>C-bus:

- Configure the device to work with FIN input
- Select the signal to apply on FOUT pin
- Play with manual frequencies and spread spectrum

8.4.3 Regulators

The regulator has two main areas:

- Low voltage (LV) regulators configuration
- VPRE compensation network calculation

Each regulator can either be enabled or disabled by I2C. The thermal shutdown behavior can be configured to either shutdown the regulator, or shutdown the regulator and transition to deep fail-safe. The write button applies to the entire table. The VPRE compensation network calculator helps to define the value for VPRE external compensation network.



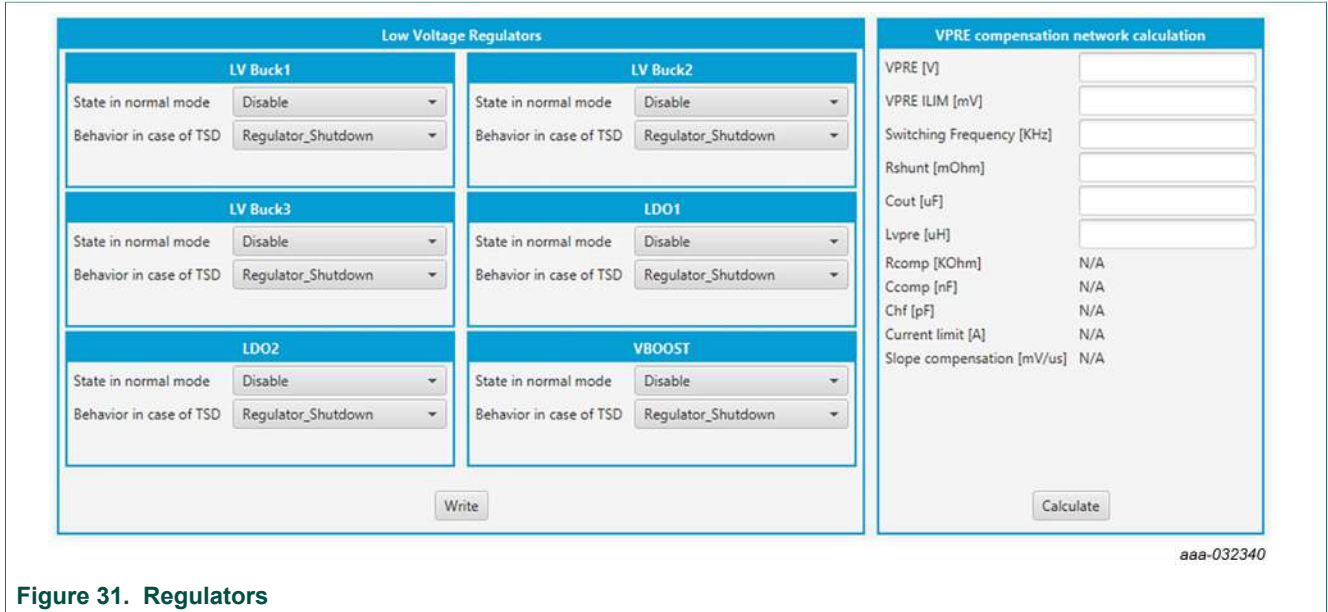

Figure 31. Regulators

8.4.4 Measurements

This tab enables two features:

- Read any of the AMUX signals over time
- Display regulator voltage summary

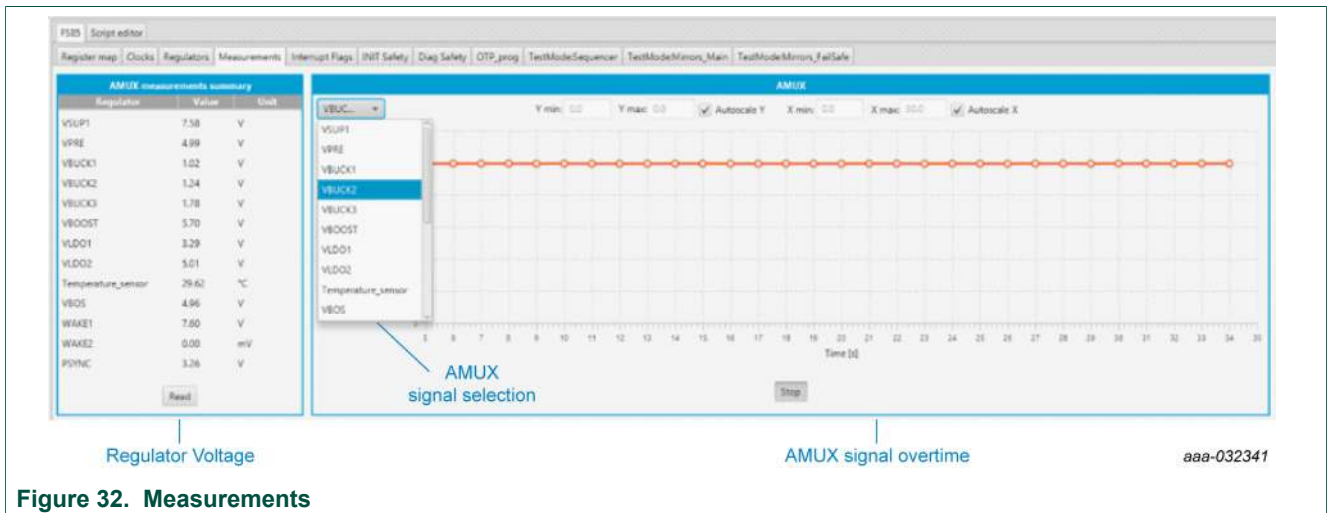

Figure 32. Measurements

### 8.4.5 Interrupt flags

This tab allows you to set or clear flags. It is also possible to mask the interruption.

The screenshot shows a software interface for configuring interrupt flags. At the top, there is a navigation bar with tabs: Register map, Clocks, Regulators, Measurements, Interrupt Flags (selected), INIT Safety, Diag Safety, OTP\_prog, TestMode:Sequencer, and TestMode:Mirrors\_M. Below the navigation bar are four panels, each with a title and a table of flags.

**Over/under-voltage**

	Status	Clear	Mask
VSUP UVH	Red	<input checked="" type="checkbox"/>	<input type="checkbox"/>
VSUP UVL	Red	<input checked="" type="checkbox"/>	<input type="checkbox"/>
VSUP UV7	Red	<input checked="" type="checkbox"/>	<input type="checkbox"/>
VPRE UVH	Red	<input checked="" type="checkbox"/>	<input type="checkbox"/>
VPRE UVL	Red	<input checked="" type="checkbox"/>	<input type="checkbox"/>
VPRE FB_OV	Green	<input type="checkbox"/>	<input type="checkbox"/>
VBOS UVH	Red	<input checked="" type="checkbox"/>	<input type="checkbox"/>
VBOOST UVH	Red	<input checked="" type="checkbox"/>	<input type="checkbox"/>
VBOOST OV	Green	<input type="checkbox"/>	<input type="checkbox"/>

**Over-temperature**

	Status	Clear	Mask
LDO1 shutdown	Green	<input type="checkbox"/>	<input type="checkbox"/>
LDO2 shutdown	Green	<input type="checkbox"/>	<input type="checkbox"/>
BUCK1 shutdown	Green	<input type="checkbox"/>	<input type="checkbox"/>
BUCK2 shutdown	Green	<input type="checkbox"/>	<input type="checkbox"/>
BUCK3 shutdown	Green	<input type="checkbox"/>	<input type="checkbox"/>
VBOOST shutdown	Green	<input type="checkbox"/>	<input type="checkbox"/>
BOS			<input type="checkbox"/>

**Over-current**

	Status	Clear	Mask
LDO1	Green	<input type="checkbox"/>	<input type="checkbox"/>
LDO2	Green	<input type="checkbox"/>	<input type="checkbox"/>
BUCK1	Green	<input type="checkbox"/>	<input type="checkbox"/>
BUCK2	Green	<input type="checkbox"/>	<input type="checkbox"/>
BUCK3	Green	<input type="checkbox"/>	<input type="checkbox"/>
VBOOST			<input type="checkbox"/>
VPRE	Green	<input type="checkbox"/>	<input type="checkbox"/>

**Miscellaneous**

	Status	Clear	Mask
LDO1 ST	Green		
LDO2 ST	Green		
BUCK1 ST	Green		
BUCK2 ST	Green		
BUCK3 ST	Green		
VBOOST ST	Green		
WK1 FLG	Red	<input checked="" type="checkbox"/>	<input type="checkbox"/>
WK2 FLG	Green	<input type="checkbox"/>	<input type="checkbox"/>
WK1 RT	Red		
WK2 RT	Green		

Buttons: Write, Read, Poll

aaa-032342

Figure 33. Interrupt flags

### 8.4.6 Diag safety

This tab shows the safety-related status and flags.

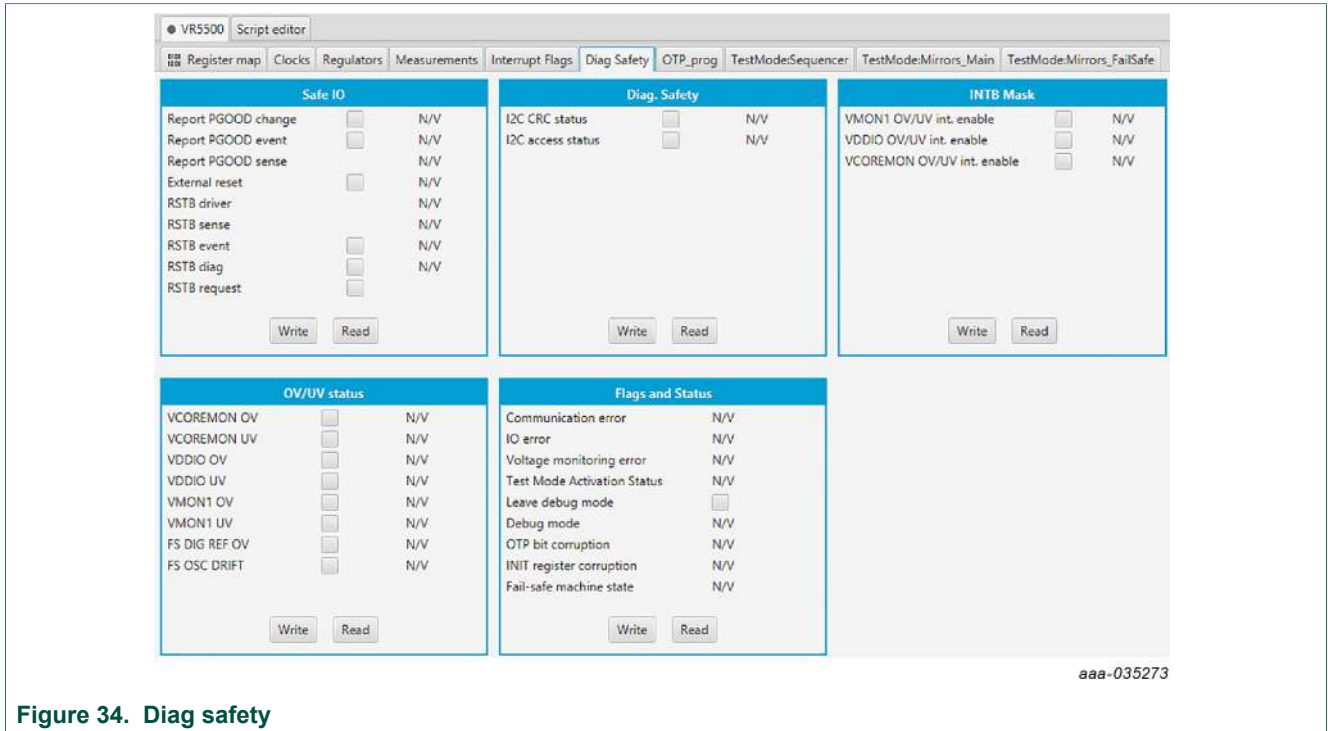

Figure 34. Diag safety

### 8.4.7 OTP programming

This tab allows you to burn the OTP using a script generated by the excel file OTP configuration; see [Section 7.1](#).

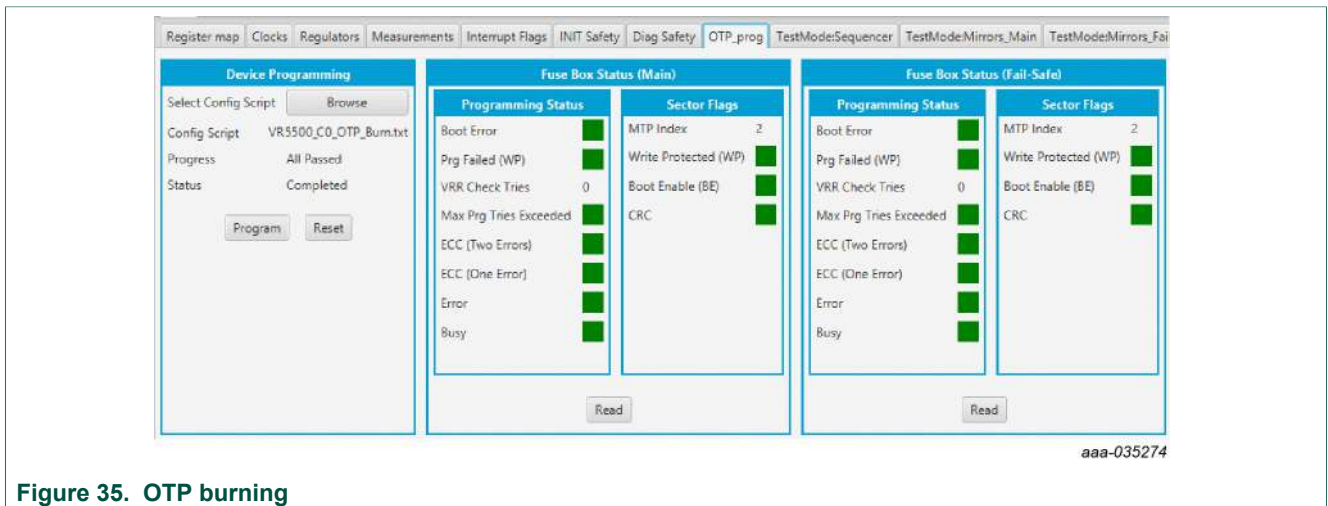

Figure 35. OTP burning

To set up the hardware before OTP burning, see [Section 7.3](#).

See [Figure 35](#) and follow the steps:

- Browse and load the script file you want to burn. The program button is then available.
- Click **Program**.

FlexGUI pops up to turn on the 8.0 V, and then turns off. The blue LED on the board indicates that an 8.0 V voltage is available on the debug pin. This voltage is used only during the burning process, and should not be applied in any other configuration. At the end of the first OTP programming, the MTP index = 1, WP, BE, and CRC flags are green.

The sector flags area status, [Table 19](#) provides the state of main flags after a read. It helps to determine how many times the part was burned.

**Table 19. OTP burning flag status**

OTP burning step	BE	WP	CRC	MTP index
OTP is not burned; mirrors empty	red	red	red	1
OTP is not burned; mirrors filled	red	red	green	1
1	green	green	green	1
2	green	green	green	2
3	green	green	green	3

Example shown in [Figure 35](#) corresponds to the OTP burning step 2 from [Table 19](#).

To check if a valid OTP configuration is already burned, switch off  $V_{BAT}$ , then on, and start the device. The device starts with the OTP configuration.

### 8.4.8 TestMode:Sequencer

The sequencer allows you to display the slot configuration for the device. To be able to access this tab, the device has to be in Test mode. The configuration is read from mirror register. It is possible to modify it and update the mirror register.

As an example, the slot sequence is filled at startup with the content of OTP fuses. Then the user can decide to modify any of the configurations coming from the OTP fuse. All these actions are done with debug pin at 5.0 V and in Test mode.

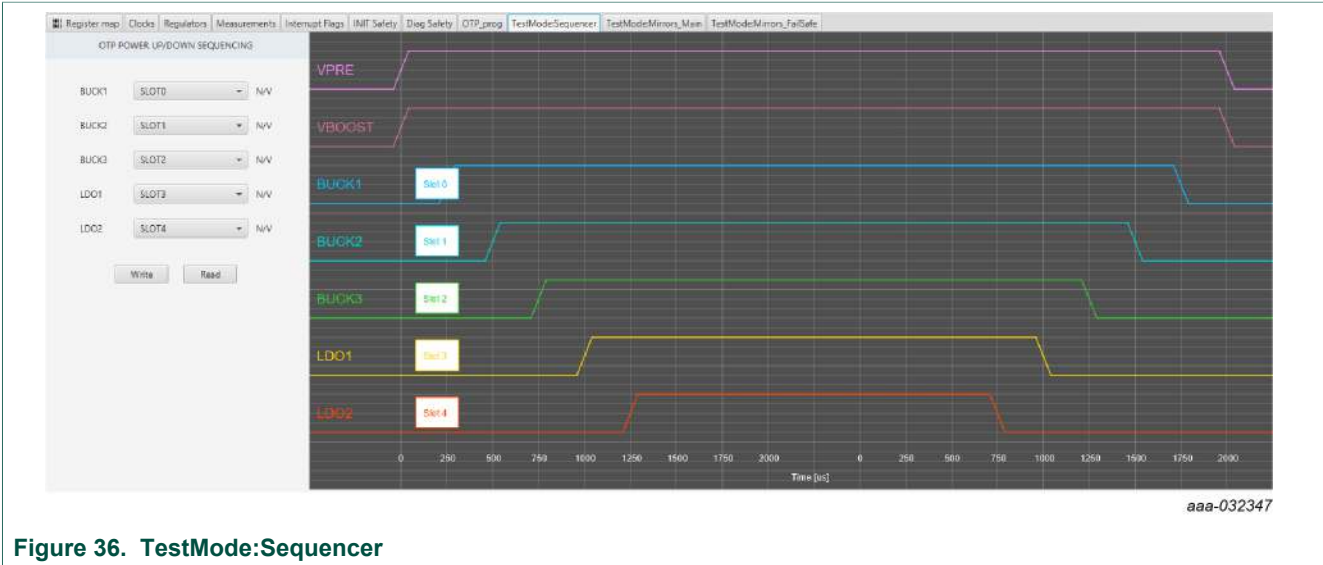

Figure 36. TestMode:Sequencer

Use the drop-down button (see [Figure 37](#)) to select the appropriate slot. The selection configuration can be sent to the device by clicking Write button. The current status can be read by using Read button.

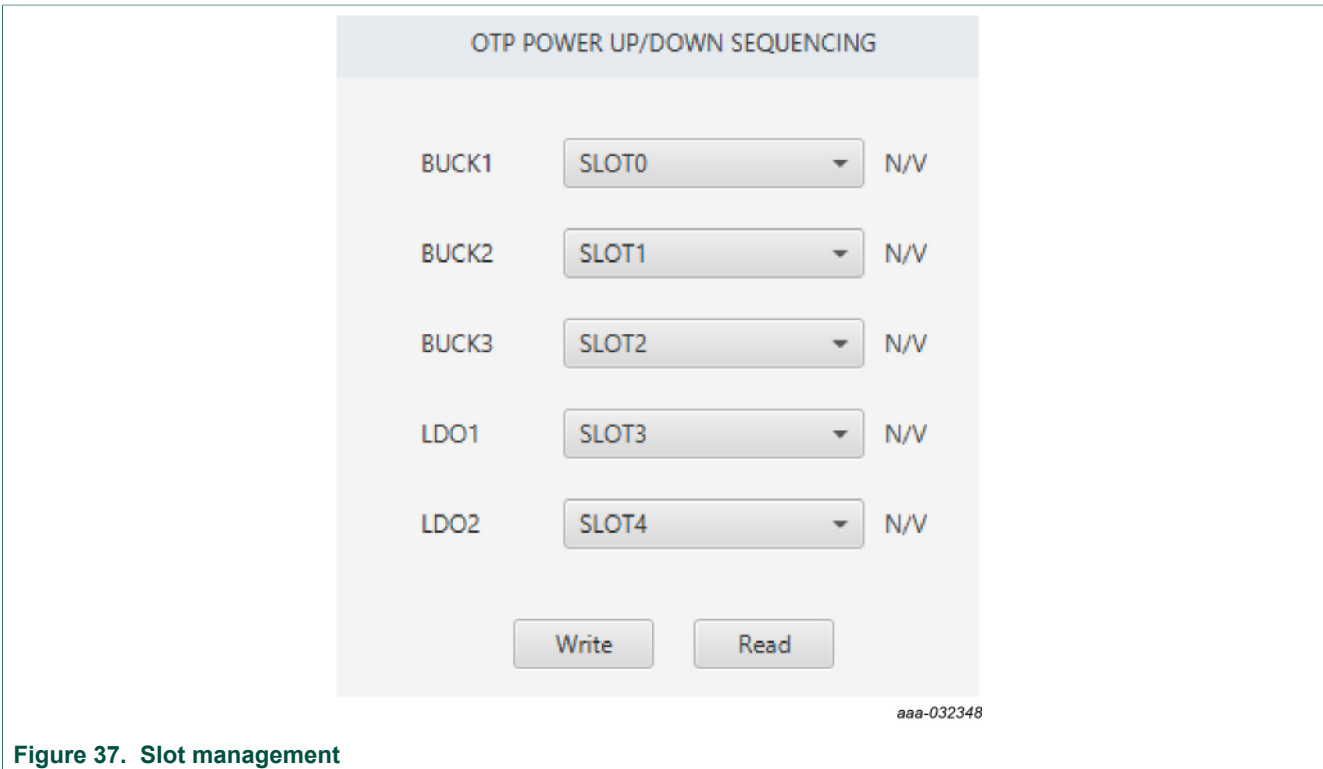

Figure 37. Slot management

### 8.4.9 TestMode:Mirrors\_Main and TestMode:Mirrors\_FailSafe

The TestMode:Mirrors\_Main and TestMode:Mirrors\_FailSafe tabs allow access to the OTP main mirrors and fail-safe registers. These tabs are available in Test mode.

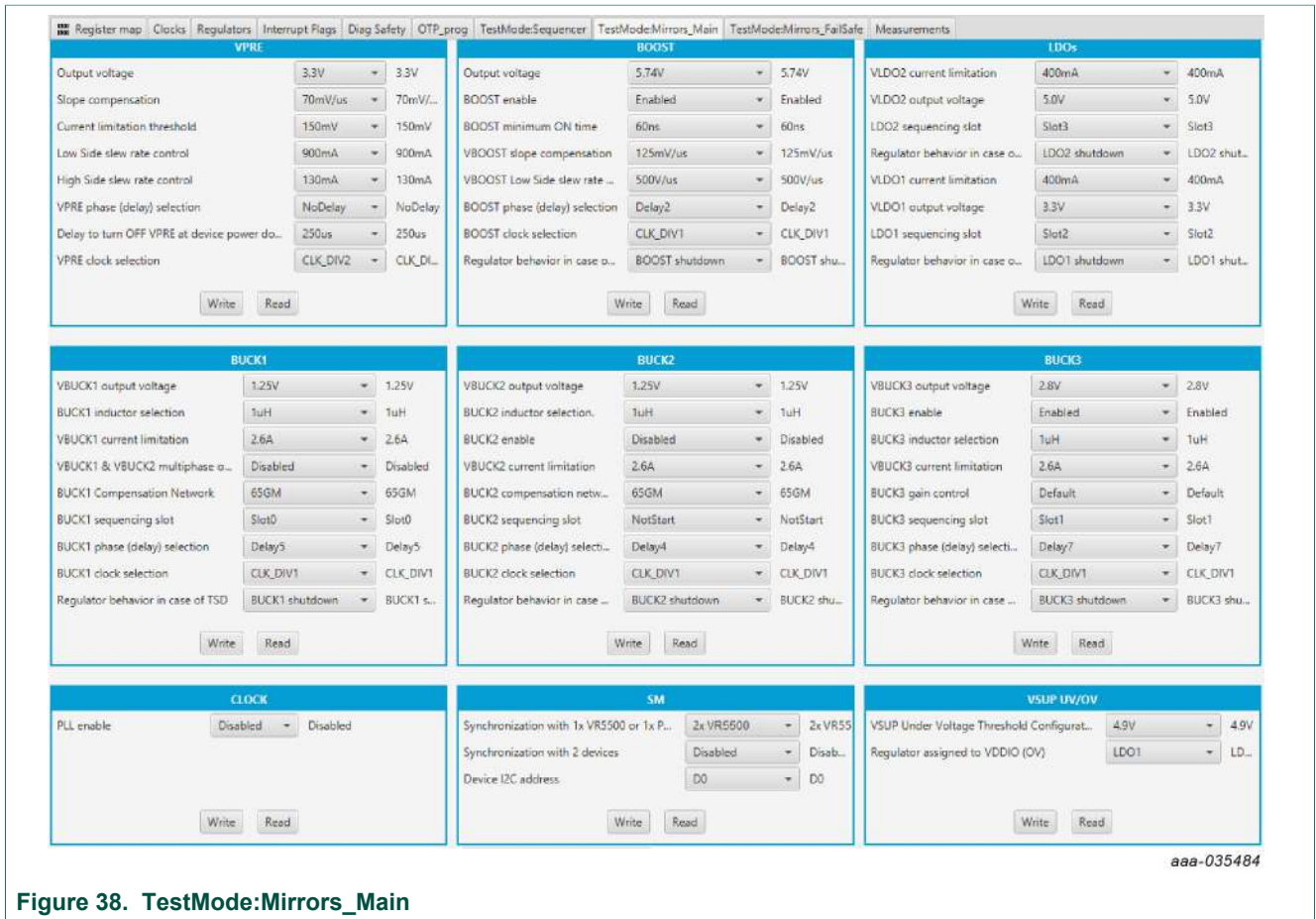

Figure 38. TestMode:Mirrors\_Main

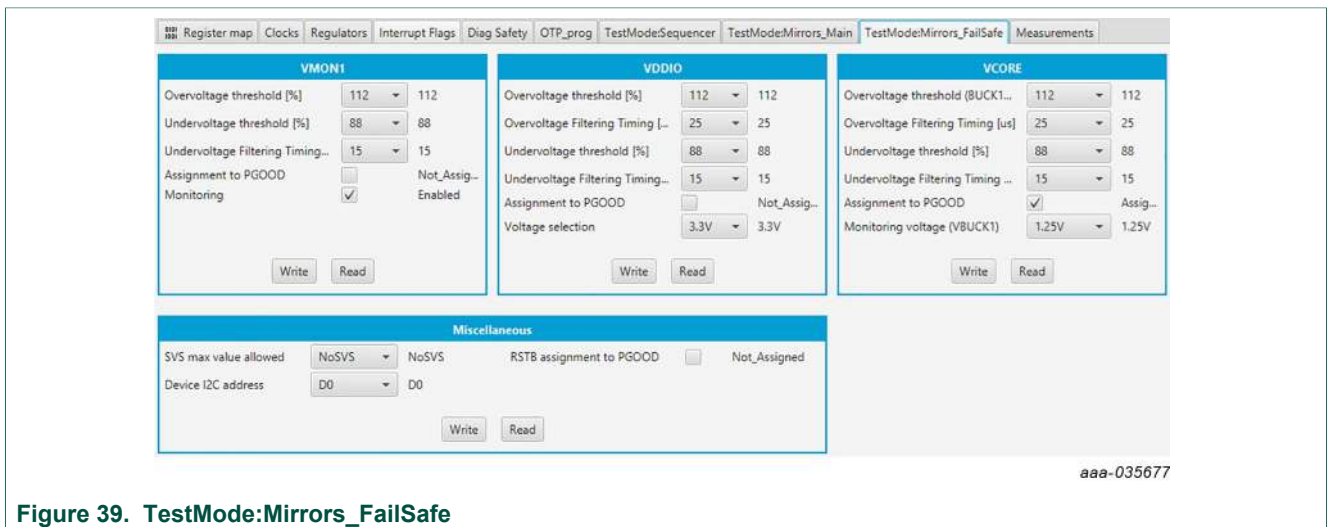

Figure 39. TestMode:Mirrors\_FailSafe

The Read button provides the current status. The Write button changes the configuration in mirror register. It can be useful, for example, to modify few parameters from OTP fuse to start up the board.

## 9 References

- [1] **KITVR5500AEEVM** — detailed information on this board, including documentation, downloads, software and tools  
<http://www.nxp.com/KITVR5500AEEVM>
- [2] **VR5500/FS5502** — product information on VR5500/FS5502, high voltage PMIC with multiple SMPS and LDO  
<http://www.nxp.com/VR5500> and <http://www.nxp.com/FS5502>
- [3] **VR5500\_OTP\_Config.xlsm** and **FS5502\_OTP\_Config.xlsm** — OTP configuration file

## 10 Revision history

### Revision history

Rev	Date	Description
v.1	20191104	initial version

## 11 Legal information

### 11.1 Definitions

**Draft** — The document is a draft version only. The content is still under internal review and subject to formal approval, which may result in modifications or additions. NXP Semiconductors does not give any representations or warranties as to the accuracy or completeness of information included herein and shall have no liability for the consequences of use of such information.

### 11.2 Disclaimers

**Limited warranty and liability** — Information in this document is believed to be accurate and reliable. However, NXP Semiconductors does not give any representations or warranties, expressed or implied, as to the accuracy or completeness of such information and shall have no liability for the consequences of use of such information. NXP Semiconductors takes no responsibility for the content in this document if provided by an information source outside of NXP Semiconductors. In no event shall NXP Semiconductors be liable for any indirect, incidental, punitive, special or consequential damages (including - without limitation - lost profits, lost savings, business interruption, costs related to the removal or replacement of any products or rework charges) whether or not such damages are based on tort (including negligence), warranty, breach of contract or any other legal theory. Notwithstanding any damages that customer might incur for any reason whatsoever, NXP Semiconductors' aggregate and cumulative liability towards customer for the products described herein shall be limited in accordance with the Terms and conditions of commercial sale of NXP Semiconductors.

**Right to make changes** — NXP Semiconductors reserves the right to make changes to information published in this document, including without limitation specifications and product descriptions, at any time and without notice. This document supersedes and replaces all information supplied prior to the publication hereof.

**Applications** — Applications that are described herein for any of these products are for illustrative purposes only. NXP Semiconductors makes no representation or warranty that such applications will be suitable for the specified use without further testing or modification. Customers are responsible for the design and operation of their applications and products using NXP Semiconductors products, and NXP Semiconductors accepts no liability for any assistance with applications or customer product design. It is customer's sole responsibility to determine whether the NXP Semiconductors product is suitable and fit for the customer's applications and products planned, as well as for the planned application and use of customer's third party customer(s). Customers should provide appropriate design and operating safeguards to minimize the risks associated with their applications and products. NXP Semiconductors does not accept any liability related to any default, damage, costs or problem which is based on any weakness or default in the customer's applications or products, or the application or use by customer's third party customer(s). Customer is responsible for doing all necessary testing for the customer's applications and products using NXP Semiconductors products in order to avoid a default of the applications and the products or of the application or use by customer's third party customer(s). NXP does not accept any liability in this respect.

**Suitability for use in automotive applications** — This NXP Semiconductors product has been qualified for use in automotive applications. Unless otherwise agreed in writing, the product is not designed, authorized or warranted to be suitable for use in life support, life-critical or safety-critical systems or equipment, nor in applications where failure or malfunction of an NXP Semiconductors product can reasonably be expected

to result in personal injury, death or severe property or environmental damage. NXP Semiconductors and its suppliers accept no liability for inclusion and/or use of NXP Semiconductors products in such equipment or applications and therefore such inclusion and/or use is at the customer's own risk.

**Export control** — This document as well as the item(s) described herein may be subject to export control regulations. Export might require a prior authorization from competent authorities.

**Evaluation products** — This product is provided on an "as is" and "with all faults" basis for evaluation purposes only. NXP Semiconductors, its affiliates and their suppliers expressly disclaim all warranties, whether express, implied or statutory, including but not limited to the implied warranties of non-infringement, merchantability and fitness for a particular purpose. The entire risk as to the quality, or arising out of the use or performance, of this product remains with customer. In no event shall NXP Semiconductors, its affiliates or their suppliers be liable to customer for any special, indirect, consequential, punitive or incidental damages (including without limitation damages for loss of business, business interruption, loss of use, loss of data or information, and the like) arising out of the use of or inability to use the product, whether or not based on tort (including negligence), strict liability, breach of contract, breach of warranty or any other theory, even if advised of the possibility of such damages. Notwithstanding any damages that customer might incur for any reason whatsoever (including without limitation, all damages referenced above and all direct or general damages), the entire liability of NXP Semiconductors, its affiliates and their suppliers and customer's exclusive remedy for all of the foregoing shall be limited to actual damages incurred by customer based on reasonable reliance up to the greater of the amount actually paid by customer for the product or five dollars (US\$5.00). The foregoing limitations, exclusions and disclaimers shall apply to the maximum extent permitted by applicable law, even if any remedy fails of its essential purpose.

**Safety of high-voltage evaluation products** — The non-insulated high voltages that are present when operating this product, constitute a risk of electric shock, personal injury, death and/or ignition of fire. This product is intended for evaluation purposes only. It shall be operated in a designated test area by personnel that is qualified according to local requirements and labor laws to work with non-insulated mains voltages and high-voltage circuits. The product does not comply with IEC 60950 based national or regional safety standards. NXP Semiconductors does not accept any liability for damages incurred due to inappropriate use of this product or related to non-insulated high voltages. Any use of this product is at customer's own risk and liability. The customer shall fully indemnify and hold harmless NXP Semiconductors from any liability, damages and claims resulting from the use of the product.

**Translations** — A non-English (translated) version of a document is for reference only. The English version shall prevail in case of any discrepancy between the translated and English versions.

**Security** — While NXP Semiconductors has implemented advanced security features, all products may be subject to unidentified vulnerabilities. Customers are responsible for the design and operation of their applications and products to reduce the effect of these vulnerabilities on customer's applications and products, and NXP Semiconductors accepts no liability for any vulnerability that is discovered. Customers should implement appropriate design and operating safeguards to minimize the risks associated with their applications and products.

### 11.3 Trademarks

Notice: All referenced brands, product names, service names and trademarks are the property of their respective owners.



## Tables

Tab. 1.	VR5500 and FS5502 comparison .....	4	Tab. 11.	Program connector (J30) .....	16
Tab. 2.	Compensation network .....	6	Tab. 12.	Evaluation board test point descriptions .....	17
Tab. 3.	Evaluation board component descriptions .....	11	Tab. 13.	Evaluation board jumper descriptions .....	18
Tab. 4.	Evaluation board indicator descriptions .....	13	Tab. 14.	SW3 .....	20
Tab. 5.	VBAT Phoenix connector (J1) .....	14	Tab. 15.	SW2 .....	20
Tab. 6.	BUCK1/BUCK2 connector (J12) .....	14	Tab. 16.	SW1 .....	20
Tab. 7.	VBOOST/BUCK3 connector (J16) .....	14	Tab. 17.	Jumper configuration .....	29
Tab. 8.	LDO1/LDO2 connector (J2) .....	15	Tab. 18.	Switch configuration .....	29
Tab. 9.	VPRE connector (J3) .....	15	Tab. 19.	OTP burning flag status .....	44
Tab. 10.	Debug connector (J29) .....	15			

## Figures

Fig. 1.	KITVR5500AEEVM .....	1	Fig. 19.	OTP_conf_summary example .....	32
Fig. 2.	VMON1 configuration .....	5	Fig. 20.	OTP script generation .....	32
Fig. 3.	VPRE compensation network .....	5	Fig. 21.	Launcher panel - bus selection .....	34
Fig. 4.	BUCK1 and BUCK2 multiphase configuration .....	6	Fig. 22.	Main panel .....	35
Fig. 5.	VDDIO selection .....	6	Fig. 23.	Disabling device mode polling .....	36
Fig. 6.	VDDI2C supply .....	7	Fig. 24.	Script editor .....	36
Fig. 7.	OTP configuration .....	7	Fig. 25.	Build a command .....	38
Fig. 8.	Debug mode entry .....	8	Fig. 26.	Send script .....	38
Fig. 9.	OTP hardware implementation .....	9	Fig. 27.	Correct format .....	38
Fig. 10.	Evaluation board featured component locations .....	10	Fig. 28.	Wrong format ("//" missing in second line) .....	38
Fig. 11.	Evaluation board indicator locations .....	13	Fig. 29.	Register map .....	39
Fig. 12.	Evaluation board connector locations .....	14	Fig. 30.	Clocks .....	40
Fig. 13.	Evaluation board test points .....	16	Fig. 31.	Regulators .....	41
Fig. 14.	Evaluation board jumper locations .....	18	Fig. 32.	Measurements .....	41
Fig. 15.	Switch locations .....	19	Fig. 33.	Interrupt flags .....	42
Fig. 16.	Typical initial configuration .....	29	Fig. 34.	Diag safety .....	43
Fig. 17.	OTP_conf_main_reg spreadsheet example .....	31	Fig. 35.	OTP burning .....	43
Fig. 18.	OTP_conf_failsafe_reg spreadsheet example .....	31	Fig. 36.	TestMode:Sequencer .....	45
			Fig. 37.	Slot management .....	45
			Fig. 38.	TestMode:Mirrors_Main .....	46
			Fig. 39.	TestMode:Mirrors_FailSafe .....	46

Contents

<b>1</b>	<b>Introduction</b>	<b>2</b>	<b>8.4</b>	Understanding the VR5500/FS5502 workspace	39
<b>2</b>	<b>Finding kit resources and information on the NXP website</b>	<b>2</b>	8.4.1	Register map	39
2.1	Collaborate in the NXP community	2	8.4.2	Clocks	40
<b>3</b>	<b>Getting ready</b>	<b>2</b>	8.4.3	Regulators	40
3.1	Kit contents	2	8.4.4	Measurements	41
3.2	Additional hardware	3	8.4.5	Interrupt flags	42
3.3	Windows PC workstation	3	8.4.6	Diag safety	43
3.4	Software	3	8.4.7	OTP programming	43
<b>4</b>	<b>Getting to know the hardware</b>	<b>3</b>	8.4.8	TestMode:Sequencer	44
4.1	Kit overview	4	8.4.9	TestMode:Mirrors_Main and TestMode:Mirrors_FailSafe	45
4.1.1	KITVR5500AEEVM features	5	<b>9</b>	<b>References</b>	<b>47</b>
4.1.2	VMON1 board configuration	5	<b>10</b>	<b>Revision history</b>	<b>47</b>
4.1.3	VPRE compensation network	5	<b>11</b>	<b>Legal information</b>	<b>48</b>
4.1.4	BUCK1 and BUCK2 multiphase configuration (VR5500 only)	6			
4.1.5	VDDI2C	6			
4.2	Device OTP user configuration	7			
4.2.1	OTP and mirrors registers	7			
4.2.2	OTP hardware implementation	8			
4.3	Kit featured components	10			
4.3.1	VR5500/FS5502: high voltage PMIC with multiple SMPS and LDO	11			
4.3.1.1	General description	11			
4.3.1.2	Features	12			
4.3.2	Indicators	13			
4.3.3	Connectors	14			
4.3.3.1	VBAT connector (J1)	14			
4.3.3.2	Output power supply connectors	14			
4.3.3.3	Debug connector (J29)	15			
4.3.3.4	Program connector (J30)	16			
4.3.4	Test points	16			
4.3.5	Jumpers	18			
4.3.6	Switches	19			
4.4	Schematic, board layout and bill of materials	20			
<b>5</b>	<b>Installing and configuring software and tools</b>	<b>20</b>			
5.1	Installing the Java JRE	20			
5.2	Installing Windows 7 FlexGUI driver	20			
5.3	Installing FlexGUI software package	28			
<b>6</b>	<b>Configuring the hardware for startup</b>	<b>29</b>			
<b>7</b>	<b>Using the KITVR5500AEEVM evaluation board</b>	<b>30</b>			
7.1	Generating the OTP configuration file	30			
7.2	Working in OTP emulation mode	33			
7.3	Programming the device with an OTP configuration	33			
<b>8</b>	<b>Using FlexGUI</b>	<b>33</b>			
8.1	Starting the FlexGUI application	33			
8.2	Establishing the connection between FlexGUI and the hardware	34			
8.3	Working with the script editor	36			
8.3.1	Script text editor	36			

Please be aware that important notices concerning this document and the product(s) described herein, have been included in section 'Legal information'.