

Alle Rechte vorbehalten. All rights reserved

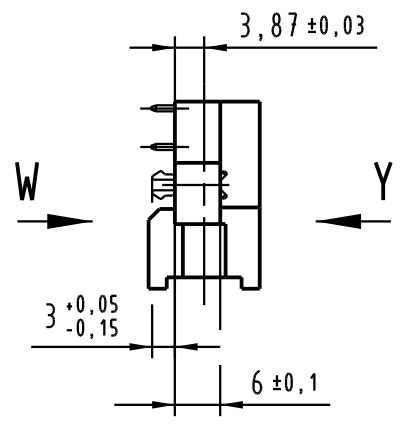

Ag over Ni		Sn over Ag over Ni		Nicht tolerierte Maße Free size tolerances	
Steckbereich contact area		Anschlußbereich termination area		IEC 60603-2	
All Dimensions in mm Original Size DIN A 3		Techn. Character.		IEC 60603-2	
		Dat.		Name	
		14.10.04		Leh.	
		14.10.04		kfoe	
		Stand.		Maßstab/Scale	
				1:1	
				2:1 10:1	
34032	07.11.06	LehT		HARTING	
32352				HARTING	
Mod.	Dat.	Name		Sub.	
		HARTING Electronics GmbH & Co. KG D-32339 ESPELKAMP		TB 09 06 315 2911	
				Blatt/page	

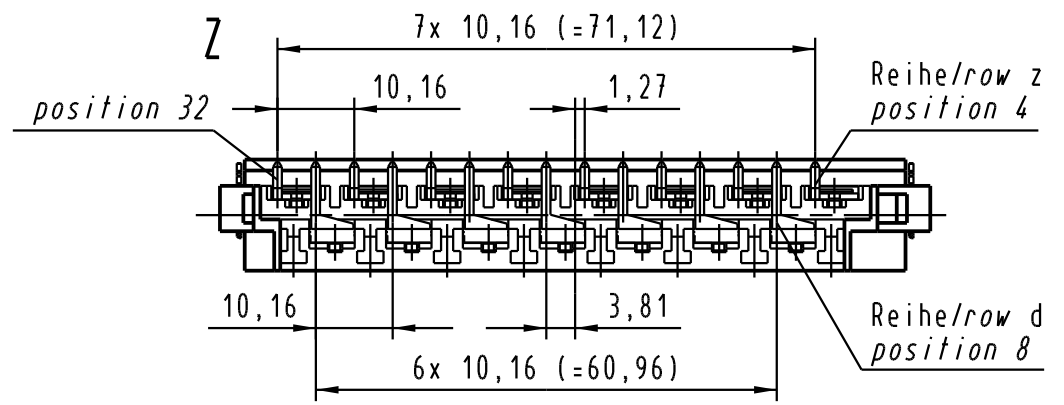
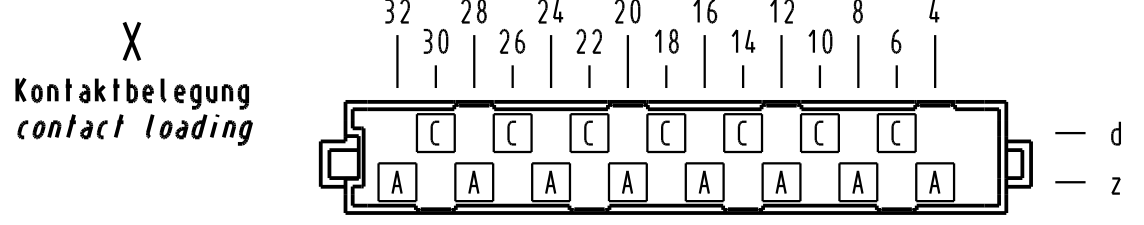
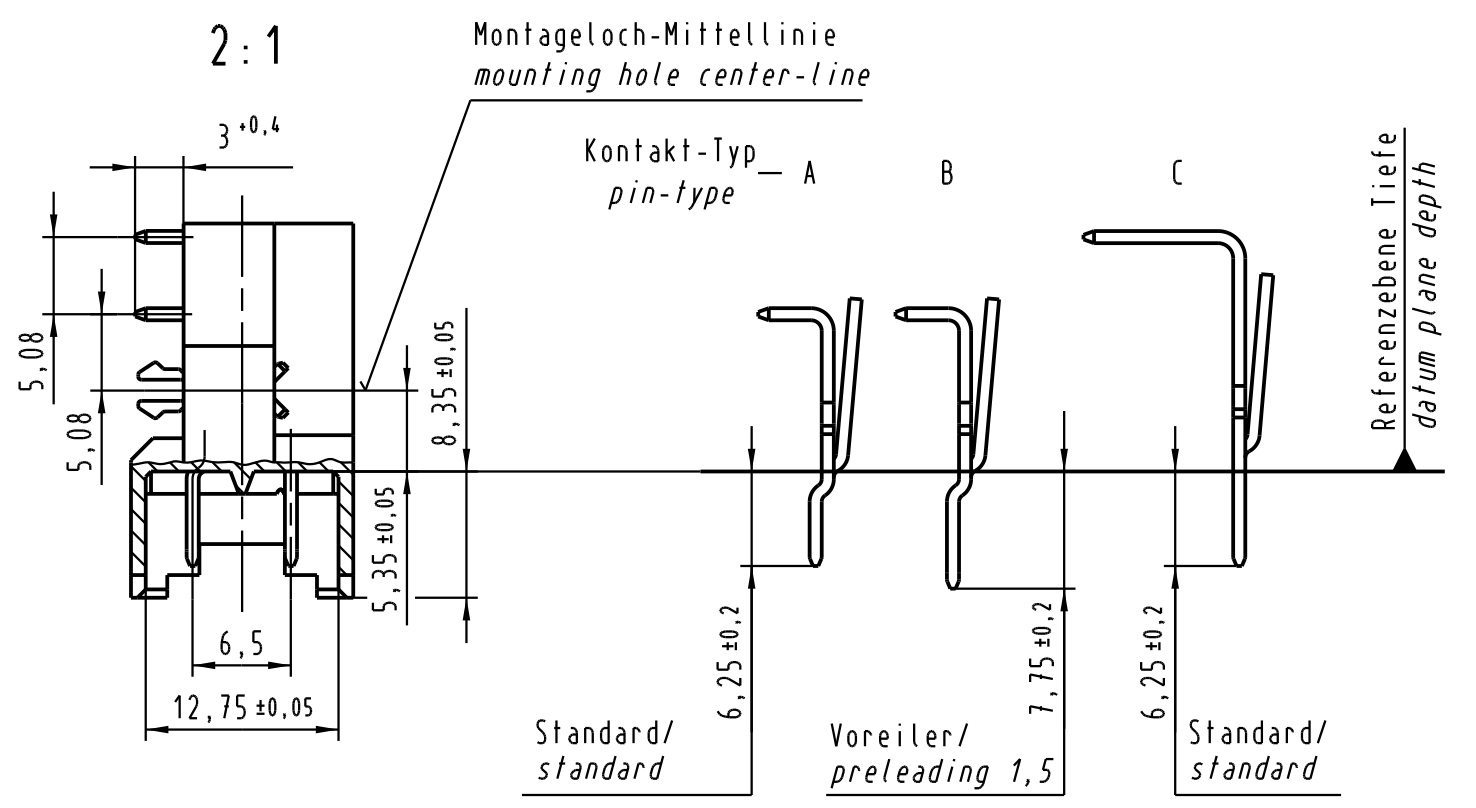
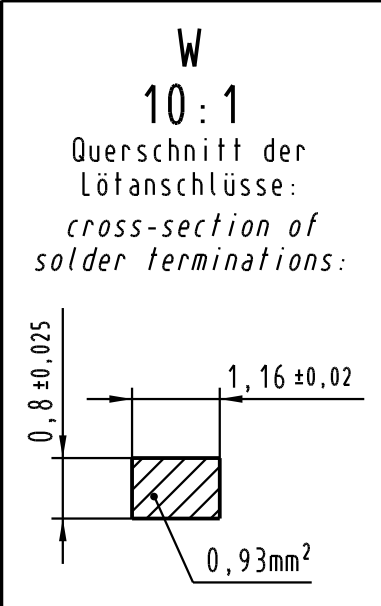
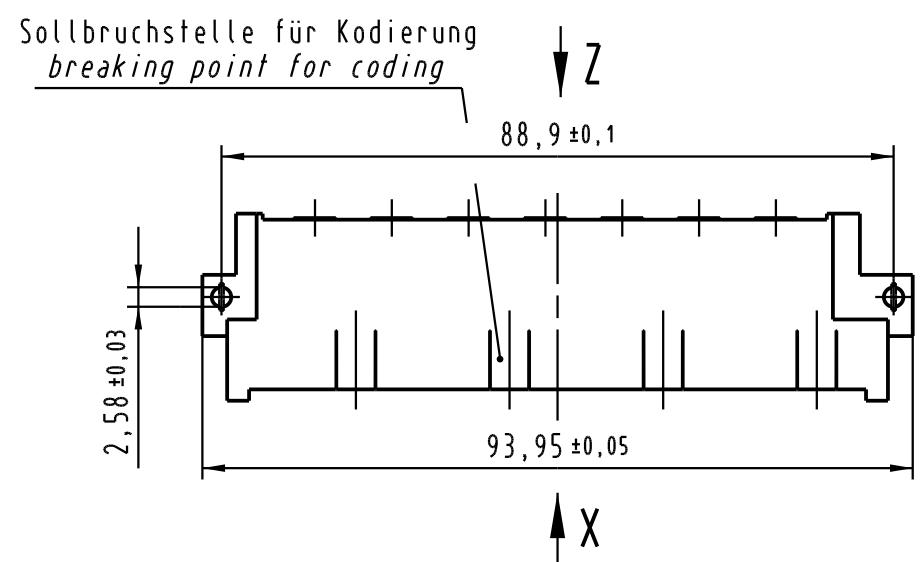
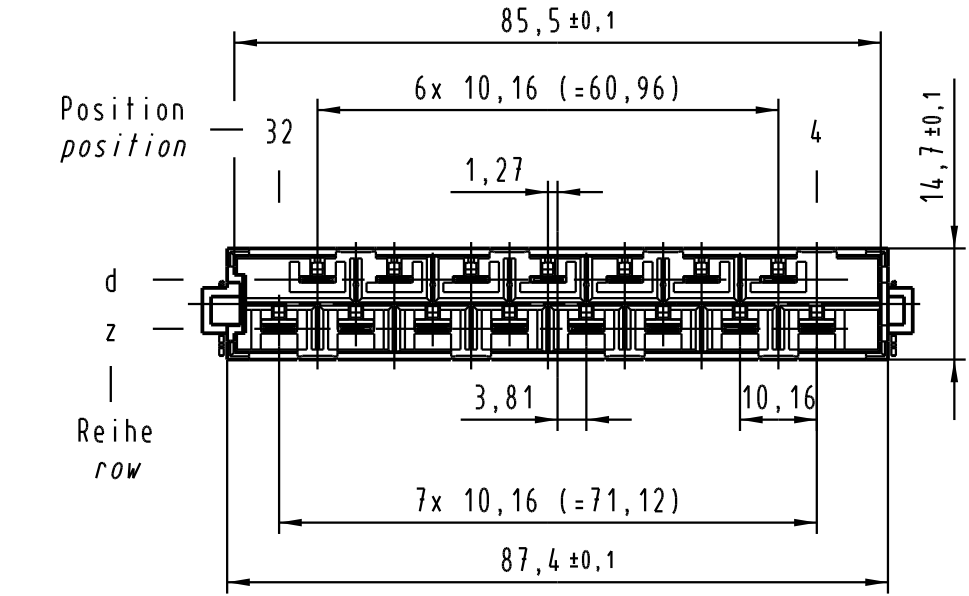
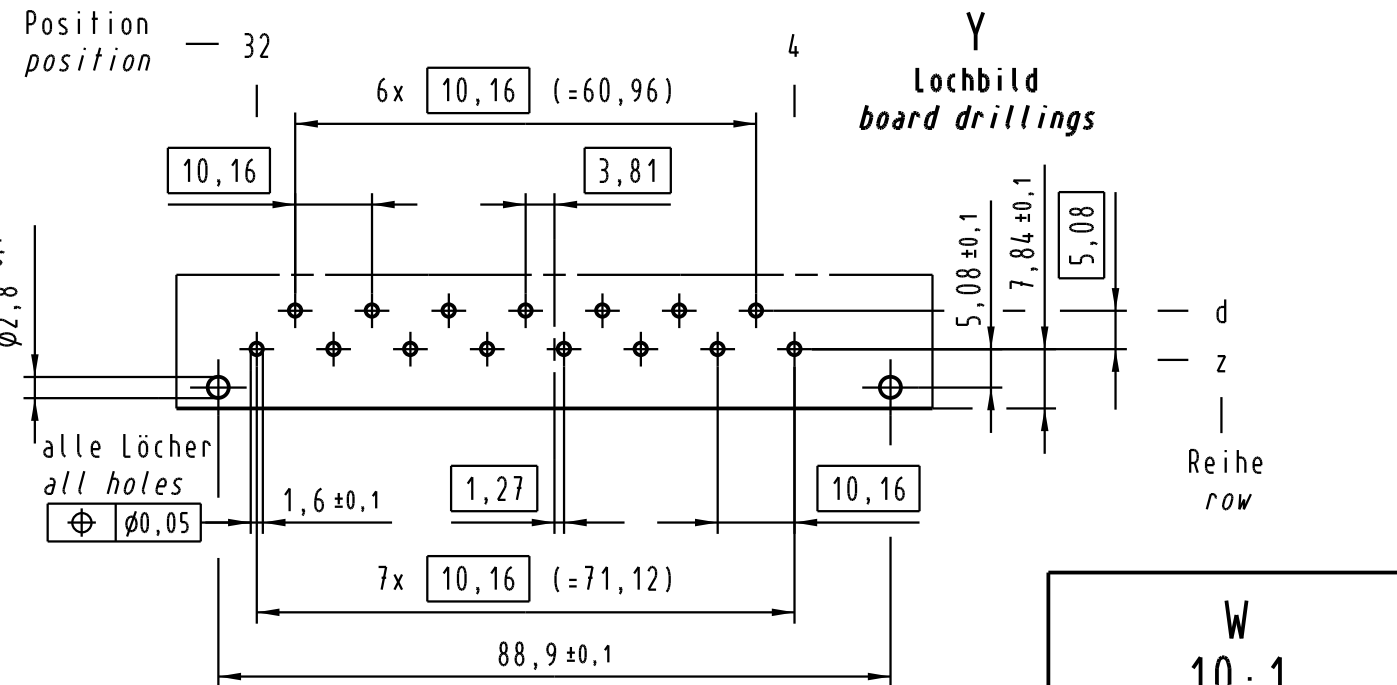
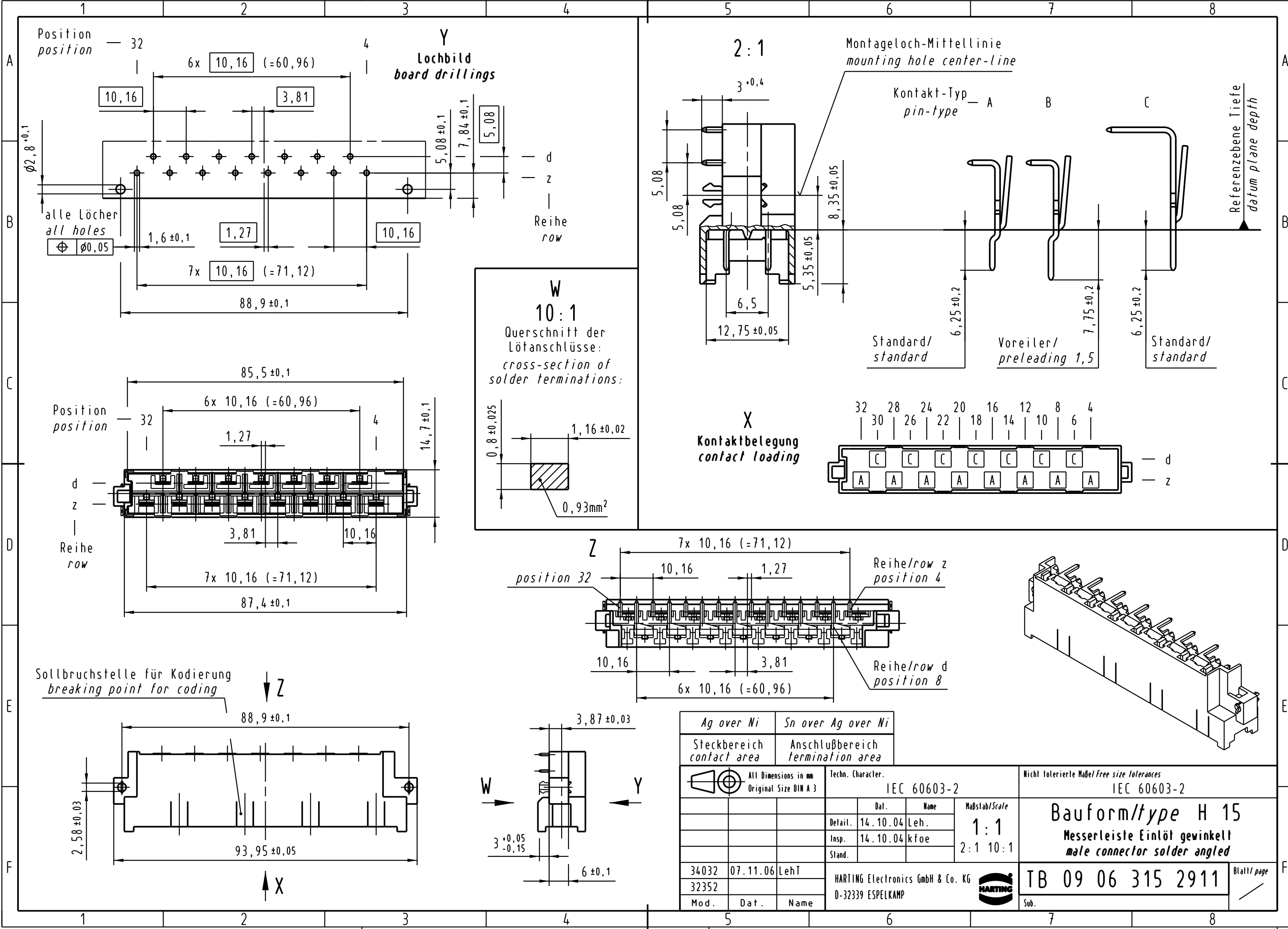