

OBSOLETE

Modular power supplies PS Part number 88950306



- Switch mode power supply regulated and protected against overloads and short-circuits, easy to integrate into switchboards and enclosures
- The potentiometer can be used to set the output voltage between 100 and 120 % (24 VDC versions) to compensate for any voltage drops on the line
- The LED continuously signals the presence of voltage at the output and, when flashing, triggering of the self-protection
- Broad range of supply voltage
- Double insulation

Part numbers

	Type	Nominal output voltage	Nominal power	Nominal output current
88950306	PS	12 V DC (11,4 V →15 V)	25 W	2,1 A

Specifications

Environmental characteristics

Conformity to standards	IEC/EN 60950-1 IEC/EN 61000-6-2 IEC/EN 61000-6-3 IEC/EN 61204-3 IEC/EN 60364-4-41 SELV : Safety Extra Low Voltage EN 55022 (CISPR22)
Certifications	CE, UL, CSA, TÜV
Emission	Harmonic : IEC / EN 61000-3-2
Operating temperature	-25 →+55 °C
Storage temperature (°C)	-40 →+70 °C
Protection class	Class 2 (Double insulation)

Electrical characteristics

Input voltage	100 →240 V AC single-phase (-15 %/+10 %)
Supply frequency range	50/60 Hz (+4 % / -6 %) or 47→53 Hz/57 →63 Hz
Output voltage	Adjustable from 100 →120 %
Peak current on energisation	< 20 A (Except for 88950302 : < 90A during 1 ms)
Regulation of line and load	± 3 %
Immunity from micro power cuts	< 10 ms (100 V AC) < 150 ms (230 V AC)
Thermal protection	Yes
Technology	Primary switch mode electronic power supplies
Short-circuit protection	Yes
Overload protection	Yes
Primary protection	Fuse gG 2 A or circuit breaker 2 A curve D for 88950303, 88950304, 88950305, 88950306, 88950307 Fuse gG 3 A or circuit breaker 3 A curve D for 88950302
Reset after overload	Automatic
Dielectric strength	Input / output 3000 VAC / 50 Hz / 1mn
Status indication	LED at the output

Mechanical characteristics

Mounting	On section, 35 x 7, 5 mm and 35 x 15 mm or on panel (2 x Ø4 mm)
Screw terminals connection capacity	Input connection 2 x 0,14 →2,5 mm ² (AWG 26...AWG 14) Output connection 1 x 0,14 →2,5 mm ² (AWG 26...AWG 14)

Dimensions (mm)

PS

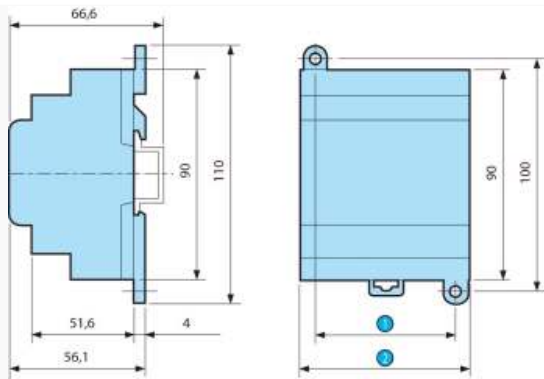

	①	②
88950305	42	54
88950306	42	54
88950303	24	36
88950304	24	36
88950307	42	54
88950302	60	72

OBSOLETE

Curves

Derating

P/Pn (%)

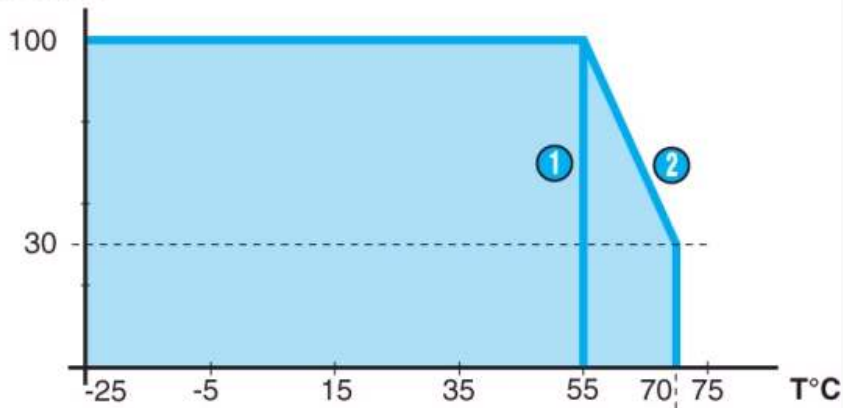

The ambient operating temperature of the Millenium power supplies is 55 °C. Above this, a derating is needed upto a maximum operating temperature of 70 °C. The chart below shows the power (compared to the nominal power) that can be permanently supplied by the power supply, depending on the operating temperature.

N°	Legend
①	88950302
②	8895030x