





Bikonvexlinsen, gefasst, aus Quarzglas







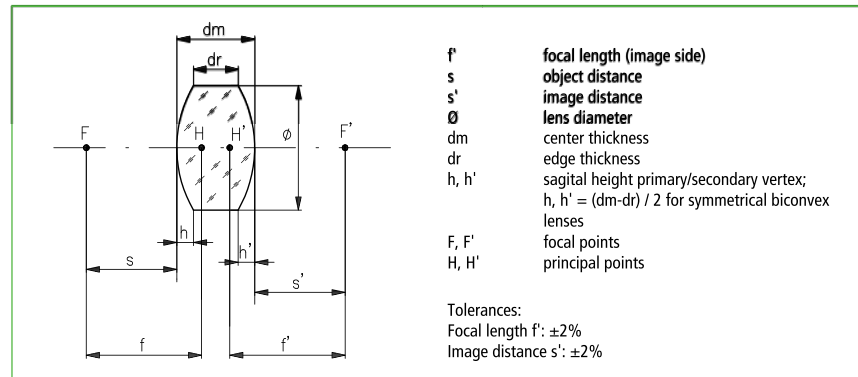













- In Fassungen kompatibel zur Mikrobank  oder Nanobank 
- Linsen bester Form für 1:1-Abbildungen
- Unbeschichtet
- Toleranzen: Brennweite f' : $\pm 2\%$, Bildentfernung s' : $\pm 2\%$
- Zwei gleiche Krümmungsradien

Symmetric-Convex Lenses, Mounted (Fused Silica)

- Lens mounts fit to Microbench  or Nanobench 
- Precision designed for 1:1 imaging
- Surfaces uncoated
- Tolerances: Focal length f' : $\pm 2\%$, Image distance s' : $\pm 2\%$
- Two equal radii of curvature



Bikonvexlinsen, gefasst, aus Quarzglas Symmetric-convex lenses, mounted, fabricated from fused silica

Fassung	Brennweite (mm)	Optik- \varnothing (mm)	Außen- $\varnothing D$ (mm)	Freier- \varnothing (mm)	dm (mm)	dr (mm)	$S, S'_{248\text{nm}}$ (mm)	$f'_{193\text{nm}}$ (mm)	$f'_{248\text{nm}}$ (mm)	C^*	Part No.
Mount	Focal length (mm)	\varnothing optics (mm)	Outer- $\varnothing D$ (mm)	Clear \varnothing (mm)	dm (mm)	dr (mm)	$S, S'_{248\text{nm}}$ (mm)	$f'_{193\text{nm}}$ (mm)	$f'_{248\text{nm}}$ (mm)	C^*	Part No.
	5	6	16	5	3	1	4.38	5.01	5.48	4	G052212000
	10	10	16	9	4	1.2	8.71	9.24	10.13	8	G052213000
	12.5	12.5	16	11.5	4.7	1	10.52	11.11	12.2	8	G052214000
	16	12.5	16	11.5	3.8	1.2	14.82	14.67	16.13	8	G052215000
	20	18	25	17	5.8	1.4	18.33	18.52	20.36	8	G063316000
	25	22.4	25	21.4	7	1.6	22.79	22.95	25.23	12	G063030000
	30	22.4	25	21.4	6	1.5	27.5	26.87	29.56	12	G063317000
	40	22.4	25	21.4	4.9	1.7	38.05	36.05	39.71	12	G063318000
	50	22.4	25	21.4	4.2	1.6	47.89	44.74	49.3	12	G063319000
	60	22.4	25	21.4	3.7	1.6	58.82	54.49	60.06	12	G063320000
	80	22.4	25	21.4	3.3	1.7	76.47	70.36	77.57	12	G063031000
	100	22.4	25	21.4	2.9	1.6	97.88	89.65	98.85	12	G063321000
	150	22.4	25	21.4	2.4	1.6	146.77	133.82	147.57	12	G063322000
	200	22.4	25	21.4	2.2	1.6	195.9	178.3	196.63	12	G063323000
	30	31.5	35	30	11.5	2	25.97	27.39	30.06	12	G063161000
	40	31.5	35	30	8.6	2	37.1	36.43	40.06	12	G063162000
	50	31.5	35	30	7.3	2.2	47.52	45.42	50	12	G063163000
	60	31.5	35	30	6.2	2	57.95	54.51	60.04	12	G063164000
	80	31.5	35	30	5.1	2	78.37	72.68	80.08	12	G063165000
	100	31.5	35	30	4.5	2	98.64	90.86	100.14	12	G063166000
	120	31.5	35	30	4.1	2.1	118.72	108.95	120.09	12	G063168000

C^* Eine Tabelle mit weiteren Spezifikationen finden Sie zu Beginn dieses Kapitels.
Please find more specifications in the table at the beginning of this chapter.