

Peak Emission Wavelength: 850nm

The 850nm infrared point source emitter is designed for applications requiring parallel beam angle, high accuracy and precision. Custom package solutions and sorting are available.

FEATURES

- > High Power Output
- > Emitting Window Diameter of 50μm
- > Double Lens: Ball Lens & Focusing Lens
- > High Reliability

APPLICATIONS

- > Fiber Optics
- > Linear & Rotary Encoder
- > Optical Communications

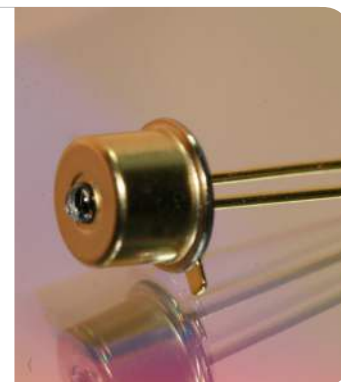

Absolute Maximum Ratings (Ta=25°C)



ITEMS	SYMBOL	RATINGS	UNIT
Forward Current (DC)	IF	80	mA
Forward Current (Pulse)*1	IFP	0.4	A
Reverse Voltage	VR	5	V
Power Dissipation	PD	160	mW
Operating Temperature Range	Topr	-30 ~ +100	°C
Storage Temperature Range	Tstg	-40 ~ +125	°C
Junction Temperature	Tj	100	°C
Lead Soldering Temperature*2	Tls	260	°C

*1: Tw=10μsec, T=10msec; *2: Time 5 Sec max, Position: Up to 3mm from the body.

Electrical & Optical Characteristics (Ta = 25°C)

ITEMS	SYMBOL	CONDITIONS	MIN	TYP	MAX	UNIT
Power Output	PO	IF=50mA	0.5	0.7	--	mW
Forward Voltage	VF	IF=50mA	--	1.9	2.5	V
Reverse Current	IR	VR=5V	--	--	10	μA
Peak Emission Wavelength	λp	IF=50mA	--	850	--	nm
Spectral Line Half Width	Δλ	IF=50mA	--	30	--	nm
Half Intensity Beam Angle	Θ	IF=50mA	--	±10	--	deg
Cut-off Frequency	fc	*1	--	45	--	MHz

*1: IF=50mA+20mAp-p.

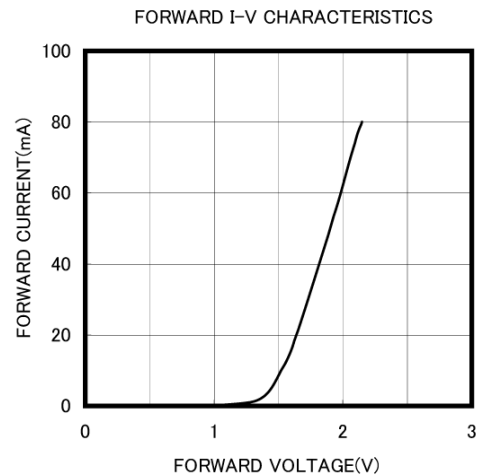
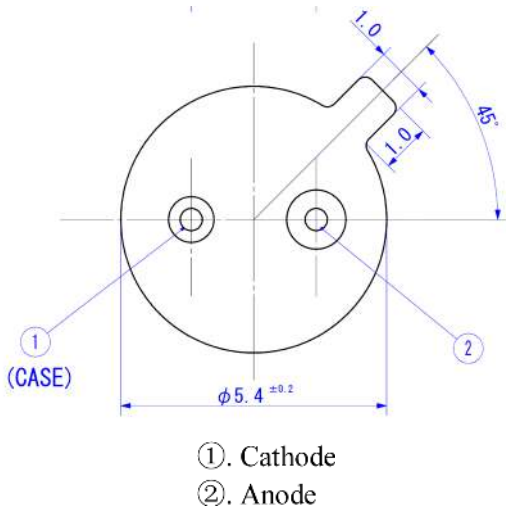
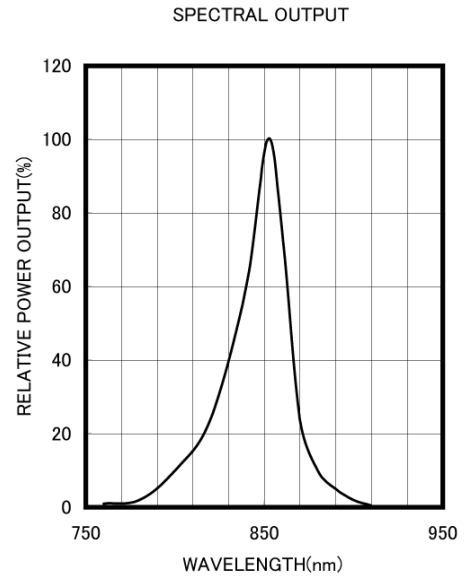
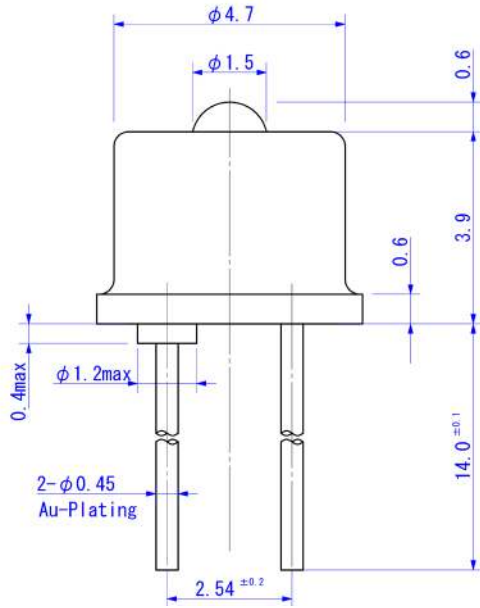

Unit: mm, Tolerance: ± 0.2

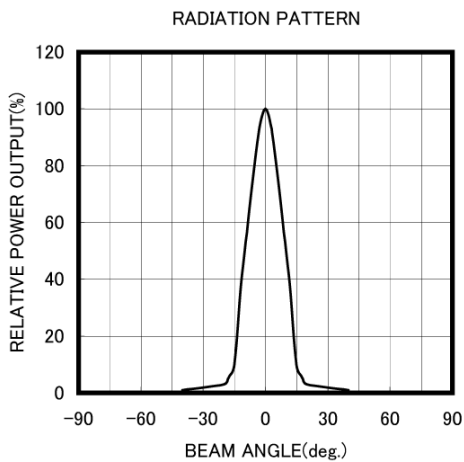
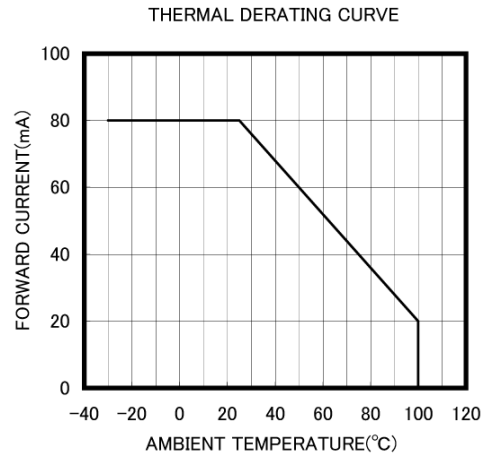
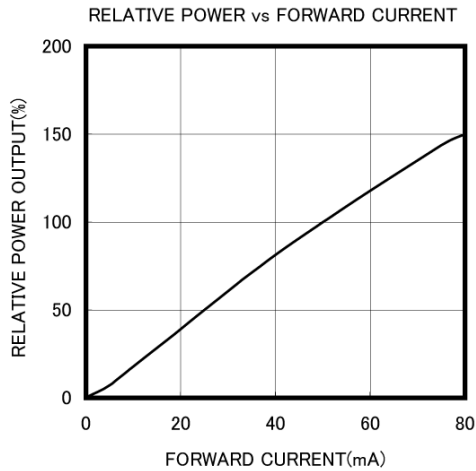

The information contained herein is subject to change without notice.

2013-1-28