

Model No: NR38150-01W-08
Rev : 1.0

Product Description

Made of superior materials, wear resistance and good shock resistance, durable small size, high sensitivity, moderate frequency flat

Mechanical Drawing

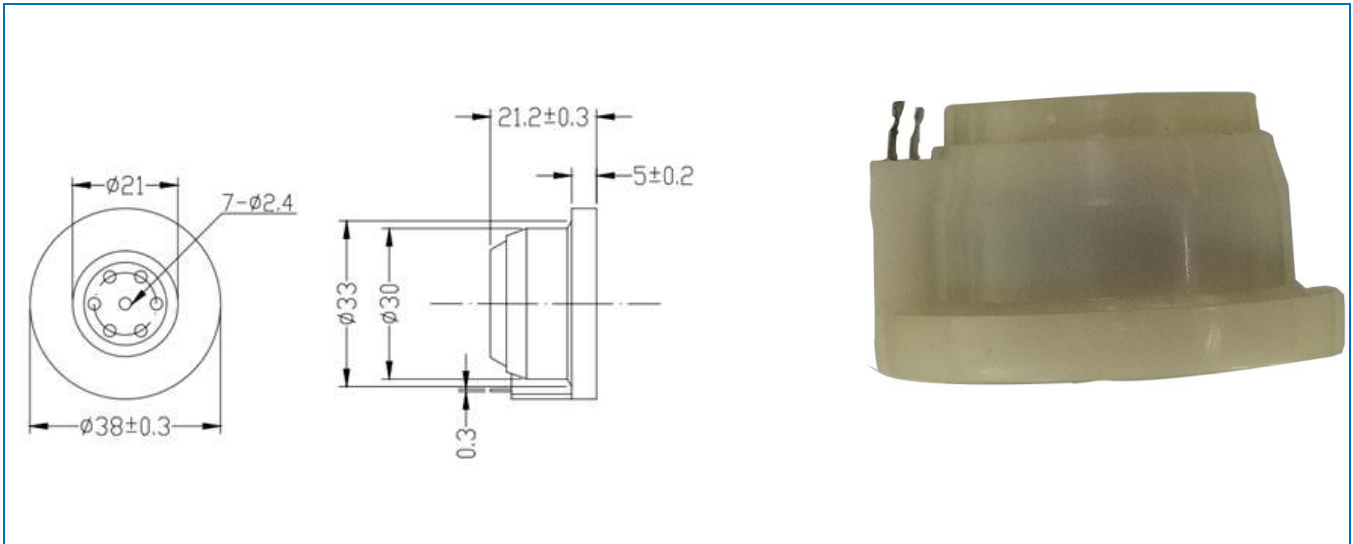

Specifications

ITEMS	DATA	UNIT	ITEMS	DATA	UNIT
Impedance	150	Ohm	F ₀	/	Hz
Sensitivity	98	dB	Frequency Range	200-5K	Hz
THD	5	%	Weight	35	g
Rated Power	10	mW	Operating Temp	-40~70	°C
Max Power	20	mW			

Frequency Response Curve

