

# TL15 In-Line Modular Tower Light Indicator

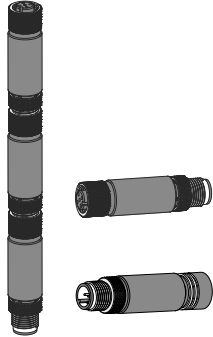

## Datasheet

The TL15 In-Line Modular Tower Light is a bright, ultra-small indicator that can be used as a standalone device or connected in-line with a tower light, sensor, or signal to give additional visual and audible indication.



- Modular, single color segmented 15 mm diameter indicator and audible
- Multiple devices can be connected together to form a tower light
- Rugged over-molded indicator segment design meets IP65, IP67, and IP68
- Each model has specific pins that activate the LEDs or audible when signaled
- TL15 tower light indicators are available in four colors: green, yellow, red, and blue
- Indicator segments operate at 12 V DC or 24 V DC with bimodal inputs that can be wired as PNP or NPN devices
- Audible segments operate from 12 V DC to 30 V DC that can be wired as PNP devices

## Models

Models	Segment Function (Input Active Pin)	Connection
TL15G4Q	Green (Pin 4)	5-Pin Male/Female M12 quick disconnect
TL15Y1Q	Yellow (Pin 1)	
TL15R2Q	Red (Pin 2)	
TL15B4Q	Blue (Pin 4)	
TL15G1Q	Green (Pin 1)	
TL15Y2Q	Yellow (Pin 2)	
TL15R5Q	Red (Pin 5)	
TL15R1Q	Red (Pin 1)	
TL15R4Q	Red (Pin 4)	
TL15GYRQ	Green (Pin 4), Yellow (Pin 1), Red (Pin 2)	
TL15BGYRQ	Blue (Pin 4), Green (Pin 1), Yellow (Pin 2), Red (Pin 5)	5-Pin Male M12 quick disconnect
TL15A5Q	Audible (Pin 5)	
TL15A1Q	Audible (Pin 1)	
TL15A2Q	Audible (Pin 2)	Indicator Segments: 5-Pin Male/Female M12 quick disconnect Audible Segment: 5-Pin Male M12 quick disconnect
TL15GYRAQ	Green (Pin 4), Yellow (Pin 1), Red (Pin 2), Audible (Pin 5)	



**Note:** Models with three or four assemblies are packaged in a kit with separate segments.

## Wiring

Table 1: Indicator Segments

Wiring	Pinouts	Pin	Wire Color	Description*
		1	Brown	Active Bimodal Input Pin: 12 V DC or 24 V DC All pins pass through if they are not the active pin-color combination.
		2	White	
		4	Black	
		5	Gray	
		3	Blue	DC Common

\*Continuity between male and female connection for all five wires, including IO-link communications. Each model only triggers off of one input pin. See model table.



Table 2: Audible Segments

Wiring	Pinout	Pin	Wire Color	Description*
		1	Brown	Active PNP Input Pin: 12 V DC to 30 V DC Pins do not pass through.
		2	White	
		4	Black	
		5	Gray	
		3	Blue	DC Common

## Specifications

### Supply Voltage

Indicator segments: 12 V DC ( $\pm 10\%$ ) at 80 mA maximum or 24 V DC ( $\pm 10\%$ ) nominal at 40 mA maximum  
 Audible segments: 12 V DC to 30 V DC  
 12 V DC: 55 mA maximum  
 24 V DC: 30 mA maximum  
 30 V DC: 25 mA maximum

### Supply Protection Circuitry

Protected against reverse polarity and transient voltages

### Audible Characteristics

Oscillation frequency: 2.9 kHz  $\pm$  250 Hz  
 Sound intensity (typical): 79 dB at 1 meter  
 Small yellow LED turns on when audible is activated

### Indicator Characteristics

1 color

Color	Dominant Wavelength (nm)	Color Coordinates <sup>1</sup>		Lumen Output (Typical at 25 °C)
		x	y	
Green	535	0.216	0.750	18
Yellow	590	0.566	0.423	22
Red	620	0.692	0.306	10
Blue	470	0.134	0.066	3

### Connections

Indicator segments: Integral male/female 5-pin M12 quick disconnect connector  
 Audible segments: Integral male 5-pin M12 quick disconnect connector

### Construction

Indicator segments:  
 Coupling material: Nickel-plated brass  
 Connector body: PVC diffuse white  
 Audible segments:  
 Coupling material: Nickel-plated brass  
 Connector body: PVC translucent black  
 Audible housing: Nylon

### Vibration and Mechanical Shock

Meets IEC 60068-2-6 requirements (Vibration: 10 Hz to 55 Hz, 0.5 mm amplitude, 5 minutes sweep, 30 minutes dwell)  
 Meets IEC 60068-2-27 requirements (Shock: 15G 11 ms duration, half sine wave)

### Environmental Rating

Indicator segments: IP65, IP67, IP68  
 Audible segments: IP60  
 UL Type 1

### Operating Conditions

Temperature: -40 °C to +50 °C (-40 °F to +122 °F)  
 Storage Temperature: -40 °C to +70 °C (-40 °F to +158 °F)

### Required Overcurrent Protection



**WARNING:** Electrical connections must be made by qualified personnel in accordance with local and national electrical codes and regulations.

Overcurrent protection is required to be provided by end product application per the supplied table.  
 Overcurrent protection may be provided with external fusing or via Current Limiting, Class 2 Power Supply.  
 Supply wiring leads < 24 AWG shall not be spliced.  
 For additional product support, go to [www.bannerengineering.com](http://www.bannerengineering.com).

Supply Wiring (AWG)	Required Overcurrent Protection (Amps)
20	5.0
22	3.0
24	2.0
26	1.0
28	0.8
30	0.5

### Certifications



**Banner Engineering Europe** Park Lane, Culliganlaan 2F bus 3, 1831 Diegem, BELGIUM



**Turck Banner LTD** Blenheim House, Blenheim Court, Wickford, Essex SS11 8YT, Great Britain



## Dimensions

All measurements are listed in millimeters [inches], unless noted otherwise. Audible segment measurements are functionally identical to indicator segment measurements.

Figure 1. Indicator segments

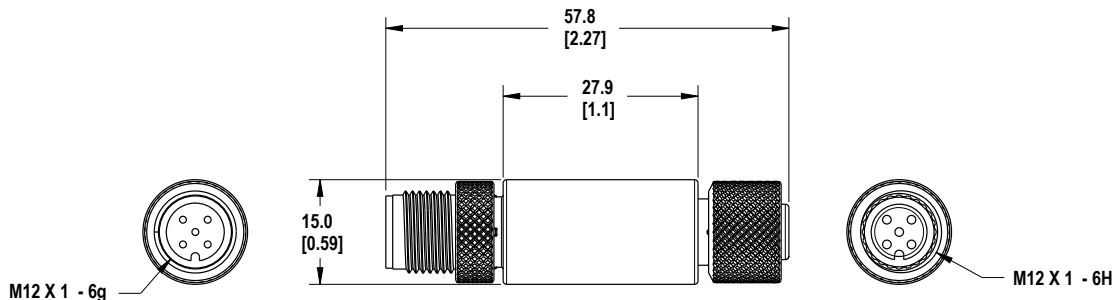

<sup>1</sup> Refer to CIE 1931 chromaticity diagram or color chart, to show equivalent color with indicated color coordinates.

Figure 2. Audible segments

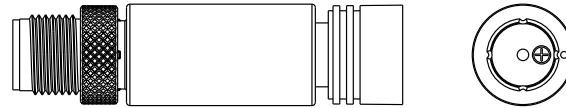

## Accessories

### Cordsets

5-Pin Threaded M12 Cordsets—Single Ended				
Model	Length	Style	Dimensions	Pinout (Female)
MQDC1-501.5	0.5 m (1.5 ft)	Straight		
MQDC1-503	0.9 m (2.9 ft)			
MQDC1-506	2 m (6.5 ft)			
MQDC1-515	5 m (16.4 ft)			
MQDC1-530	9 m (29.5 ft)			
MQDC1-560	18 m (59 ft)			
MQDC1-508RA	2 m (6.5 ft)	Right-Angle		<p>1 = Brown 2 = White 3 = Blue 4 = Black 5 = Gray</p>
MQDC1-515RA	5 m (16.4 ft)			
MQDC1-530RA	9 m (29.5 ft)			
MQDC1-560RA	19 m (62.3 ft)			

5-Pin Threaded M12 Cordsets—Double Ended					
Model	Length	Style	Dimensions	Pinout (Male)	Pinout (Female)
MQDEC-501SS	0.31 m (1.02 ft)	Male Straight/ Female Straight			
MQDEC-503SS	0.91 m (2.99 ft)				
MQDEC-506SS	1.83 m (6 ft)				
MQDEC-512SS	3.66 m (12 ft)				
MQDEC-515SS	5 m (16.4 ft)				
MQDEC-530SS	9 m (29.5 ft)				
MQDEC-550SS	15 m (49.2 ft)				
				<p>1 = Brown 2 = White 3 = Blue</p>	<p>4 = Black 5 = Gray</p>

### Brackets

#### LMBM12MAG

- Attaches to M12 cordset end
- Black polypropylene
- 11.8 kg (26 lb) pull force
- One piece

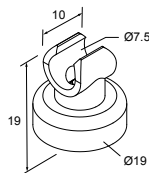

#### LMBM12SP

- Attaches to M12 cordset end
- Black polypropylene
- Supplied with thread forming hardware
- Pack of seven

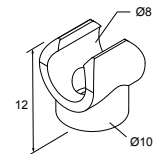

**LMBS15MAG**

- Attaches to S15 housing
- White polypropylene
- 11.8 kg (26 lb) pull force
- One piece

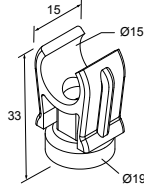

**LMBS15SP**

- Attaches to S15 housing
- White polypropylene
- Clearance for M5 or #10 hardware
- Pack of five

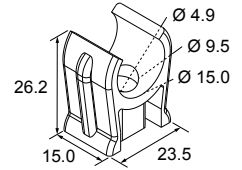

**ACC-CAP M12-10**

- 10 Caps
- Seal and protect exposed, unterminated cascade quick disconnect connectors



## Banner Engineering Corp. Limited Warranty

Banner Engineering Corp. warrants its products to be free from defects in material and workmanship for one year following the date of shipment. Banner Engineering Corp. will repair or replace, free of charge, any product of its manufacture which, at the time it is returned to the factory, is found to have been defective during the warranty period. This warranty does not cover damage or liability for misuse, abuse, or the improper application or installation of the Banner product.

**THIS LIMITED WARRANTY IS EXCLUSIVE AND IN LIEU OF ALL OTHER WARRANTIES WHETHER EXPRESS OR IMPLIED (INCLUDING, WITHOUT LIMITATION, ANY WARRANTY OF MERCHANTABILITY OR FITNESS FOR A PARTICULAR PURPOSE), AND WHETHER ARISING UNDER COURSE OF PERFORMANCE, COURSE OF DEALING OR TRADE USAGE.**

This Warranty is exclusive and limited to repair or, at the discretion of Banner Engineering Corp., replacement. **IN NO EVENT SHALL BANNER ENGINEERING CORP. BE LIABLE TO BUYER OR ANY OTHER PERSON OR ENTITY FOR ANY EXTRA COSTS, EXPENSES, LOSSES, LOSS OF PROFITS, OR ANY INCIDENTAL, CONSEQUENTIAL OR SPECIAL DAMAGES RESULTING FROM ANY PRODUCT DEFECT OR FROM THE USE OR INABILITY TO USE THE PRODUCT, WHETHER ARISING IN CONTRACT OR WARRANTY, STATUTE, TORT, STRICT LIABILITY, NEGLIGENCE, OR OTHERWISE.**

Banner Engineering Corp. reserves the right to change, modify or improve the design of the product without assuming any obligations or liabilities relating to any product previously manufactured by Banner Engineering Corp. Any misuse, abuse, or improper application or installation of this product or use of the product for personal protection applications when the product is identified as not intended for such purposes will void the product warranty. Any modifications to this product without prior express approval by Banner Engineering Corp will void the product warranties. All specifications published in this document are subject to change; Banner reserves the right to modify product specifications or update documentation at any time. Specifications and product information in English supersede that which is provided in any other language. For the most recent version of any documentation, refer to: [www.bannerengineering.com](http://www.bannerengineering.com).

For patent information, see [www.bannerengineering.com/patents](http://www.bannerengineering.com/patents).