



ELECTRONICS, INC.
44 FARRAND STREET
BLOOMFIELD, NJ 07003
(973) 748-5089
<http://www.nteinc.com>

NTE532 High Voltage Multiplier 6-Step Silicon Tripler w/Resistor to Focus Tap

Electrical Characteristics:

Input, Peak-to-Peak (No Load)	12kV
Maximum Continuous Output (at 2mA, No Load)	30kV
Output Lead Length	23 inches

Schematic:

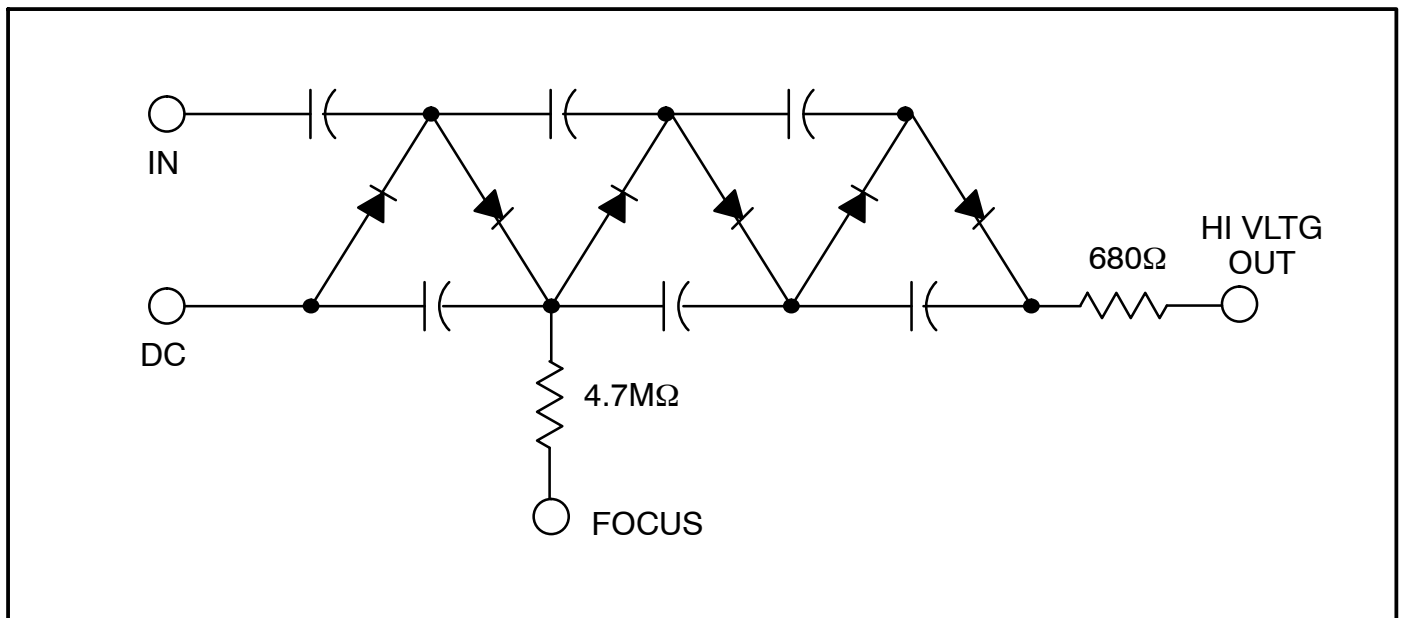

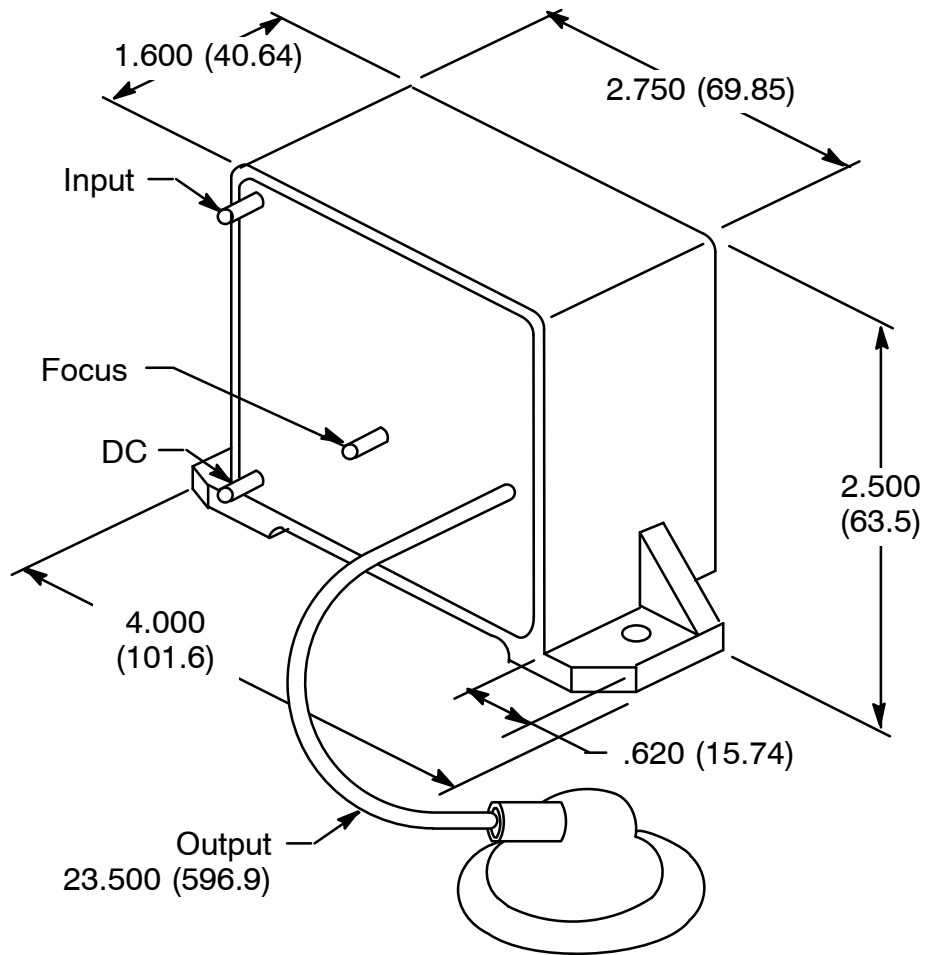

Mounting Holes
 .190 (4.82) Dia
 .190 (4.82) x .406 (10.31) Slots
 3.380 (85.85) C_L to C_L