

**PLUG MATED TO R/A RECEPTACLE
MATED PROFILE**

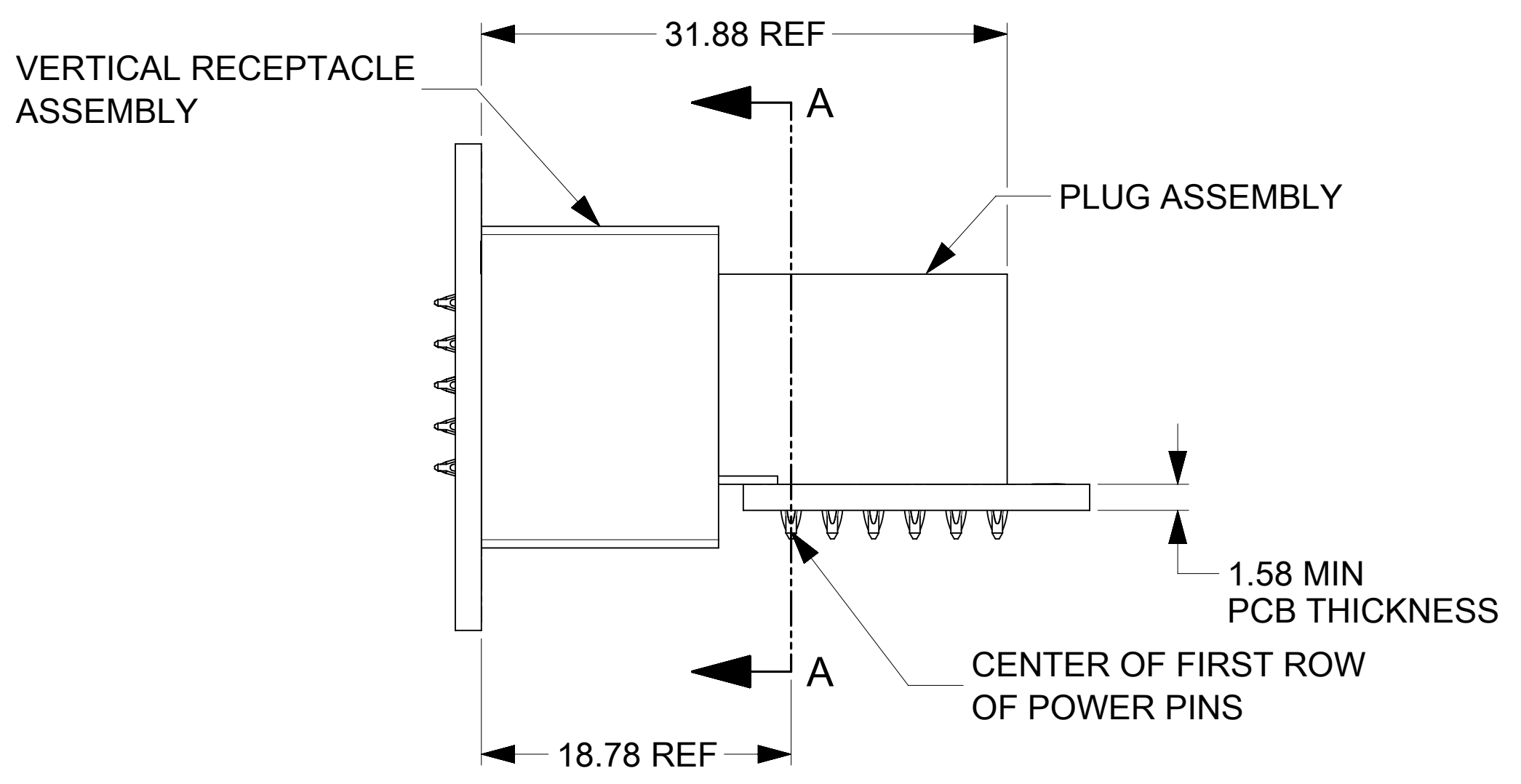

**PLUG MATED TO VERTICAL RECEPTACLE
MATED PROFILE**

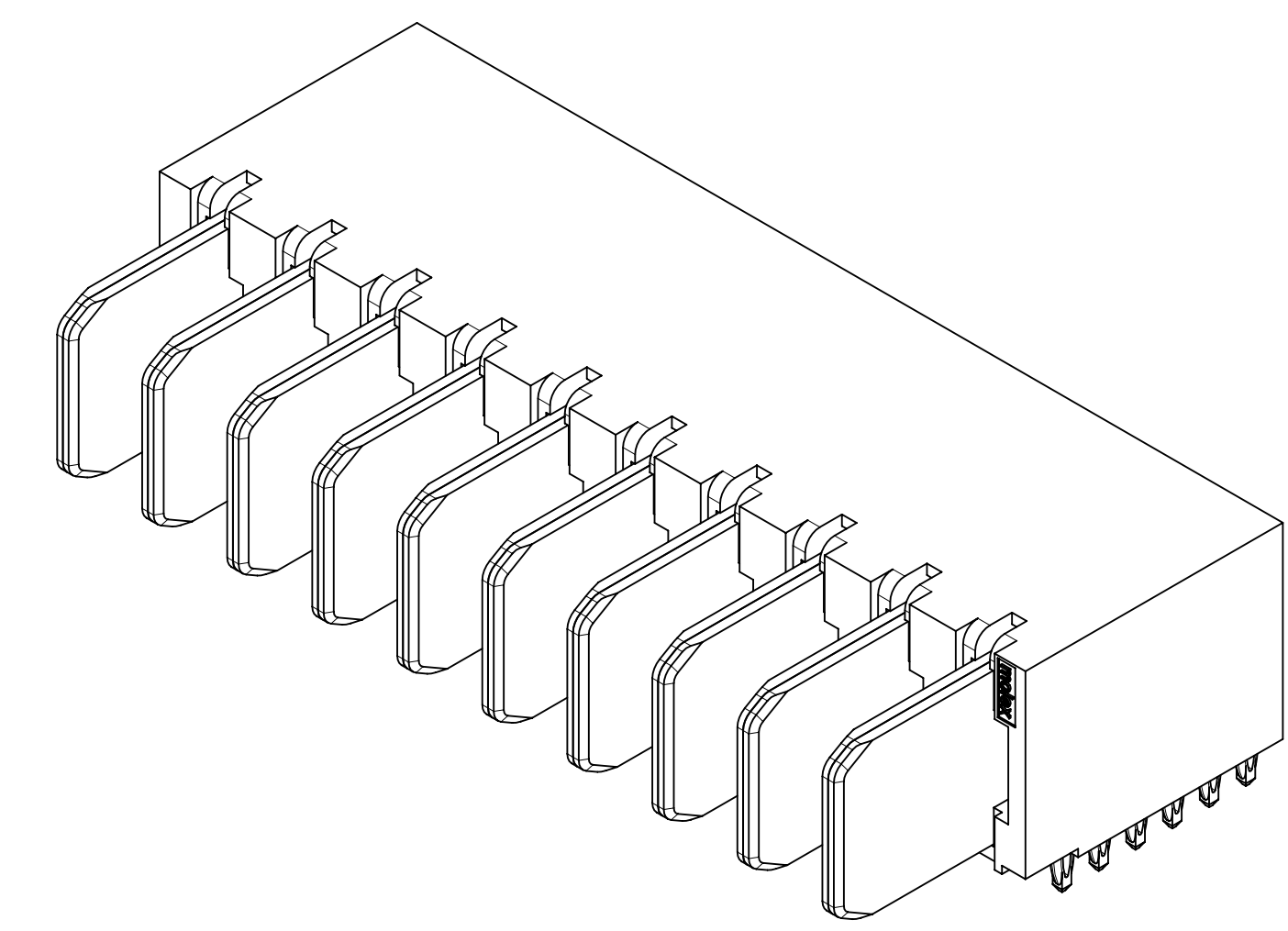
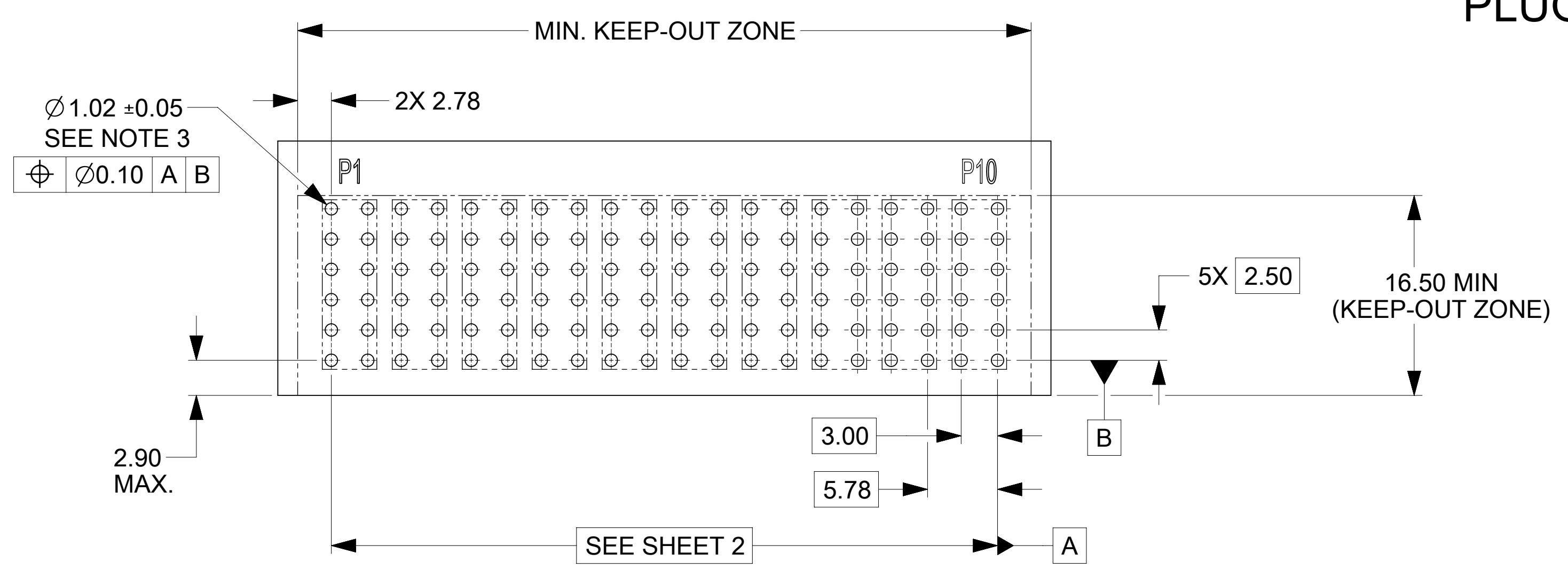
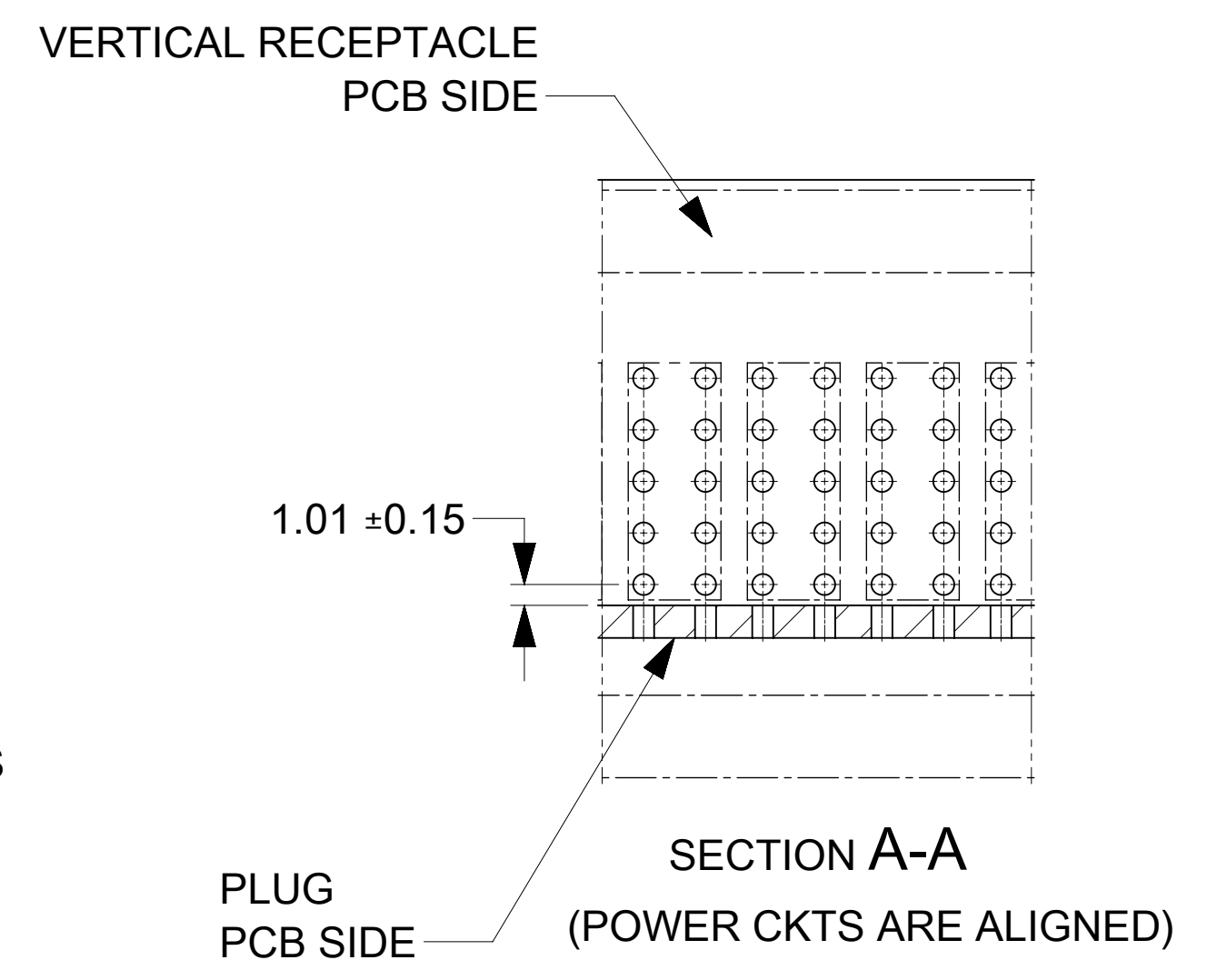

RECOMMENDED PCB LAYOUT AND KEEP-OUT ZONE

- NOTES:**
- MATERIAL:**
 - HOUSINGS: LCP UL94, V-0, COLOR : BLACK
 - TERMINALS: HIGH CONDUCTIVITY COPPER ALLOY
 - PLATING: 1.27 μm (50 μin) NICKEL OVERALL WITH 2.54 μm (100 μin) SELECTIVE TIN ON TAILS AND 0.762 μm (30 μin) SELECTIVE GOLD ON CONTACT AREA
 - PACKAGING:** ASSEMBLIES TO BE TRAY PACKED PER PACKAGING SPEC: 2141130010-PK.
 - PLATED THRU HOLE SIZE,** REFER TO PRODUCT SPEC. FOR DETAILS.
 - PRODUCT SPEC:** 2141130000-PS.
 - PRODUCT TO MEET** RoHS REQUIREMENTS.
 - PLUG ASSEMBLY MATES TO MOLEX RECEPTACLES** 219563XXXX-SD AND 219564XXXX-SD, SEE DRAWINGS FOR DETAILS.
 - TAIL DESIGN:** COMPLIANT PIN.
 - POWER TERMINALS ARE LUBRICATED.**
 - APPLICATION SPECIFICATION:** 2141130000-AS (FOR COMPLIANT TAILS ONLY).

THIS DRAWING CONTAINS INFORMATION THAT IS PROPRIETARY TO MOLEX ELECTRONIC TECHNOLOGIES, LLC AND SHOULD NOT BE USED WITHOUT WRITTEN PERMISSION										
DIMENSION UNITS	SCALE	CURRENT REV DESC:								
mm	3:1									
GENERAL TOLERANCES (UNLESS SPECIFIED)										
ANGULAR TOL	± °									
4 PLACES	±									
3 PLACES	±									
2 PLACES	± 0.25									
1 PLACE	± 0.3									
0 PLACES	±									
DRAFT WHERE APPLICABLE MUST REMAIN WITHIN DIMENSIONS		THIRD ANGLE PROJECTION	DRAWING	SERIES	MATERIAL NUMBER	CUSTOMER	SHEET NUMBER			
			D-SIZE	219562	SEE CHART		1 OF 2			
		EC NO: 745288		2023/03/21		 GUARDIAN HD RA PLUG POWER ONLY UNGUIDED PF PRODUCT CUSTOMER DRAWING				
		DRWN: LZABJANOVSKI		2023/04/10						
		CHK'D: JAYK1		2023/04/10						
		APPR: JAYK1		2023/04/10		DOCUMENT NUMBER		DOC TYPE	DOC PART	REVISION
		INITIAL REVISION:		2022/03/29		2195629003-SD		PSD	000	A1
		DRWN: LZABJANOVSKI		2022/08/04						
		APPR: BPISZCZOR								

PART NUMBER	CONFIGURATION	QUANTITY PER CARTON (DU)
219562-0031	1P	656

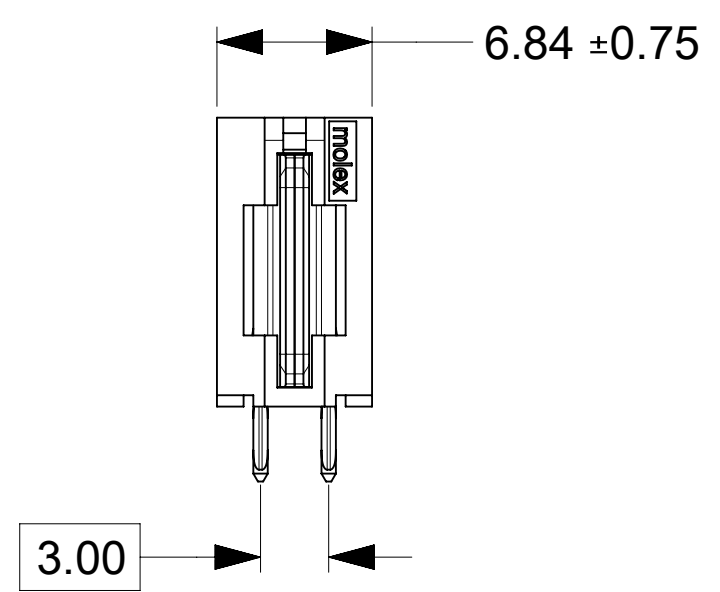

PART NUMBER	CONFIGURATION	QUANTITY PER CARTON (DU)
219562-0032	2P	352

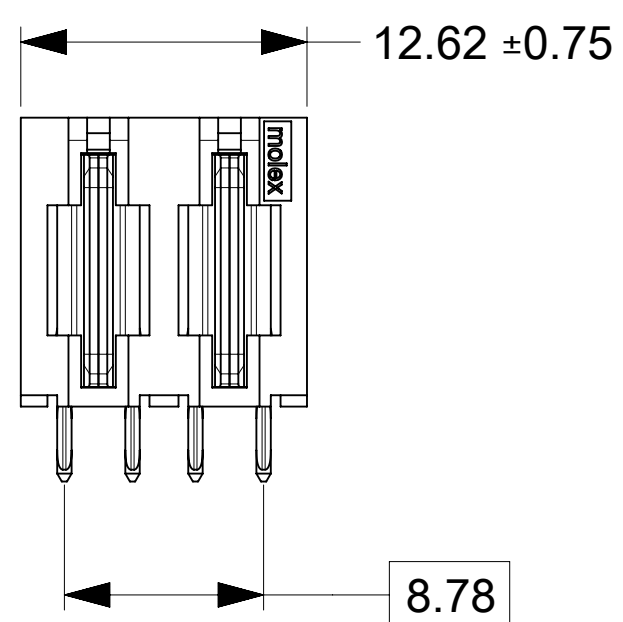

PART NUMBER	CONFIGURATION	QUANTITY PER CARTON (DU)
219562-0033	3P	240

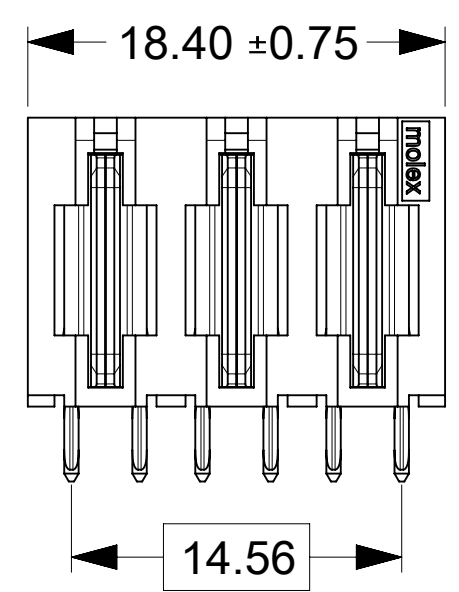

PART NUMBER	CONFIGURATION	QUANTITY PER CARTON (DU)
219562-0034	4P	176

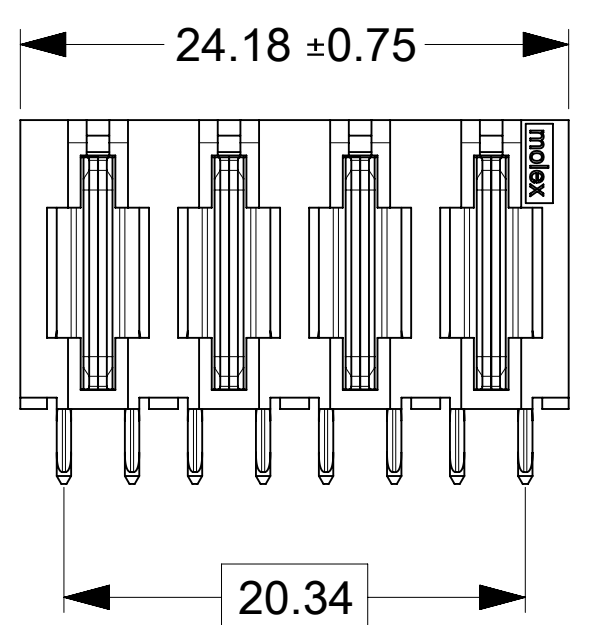

PART NUMBER	CONFIGURATION	QUANTITY PER CARTON (DU)
219562-0035	5P	144

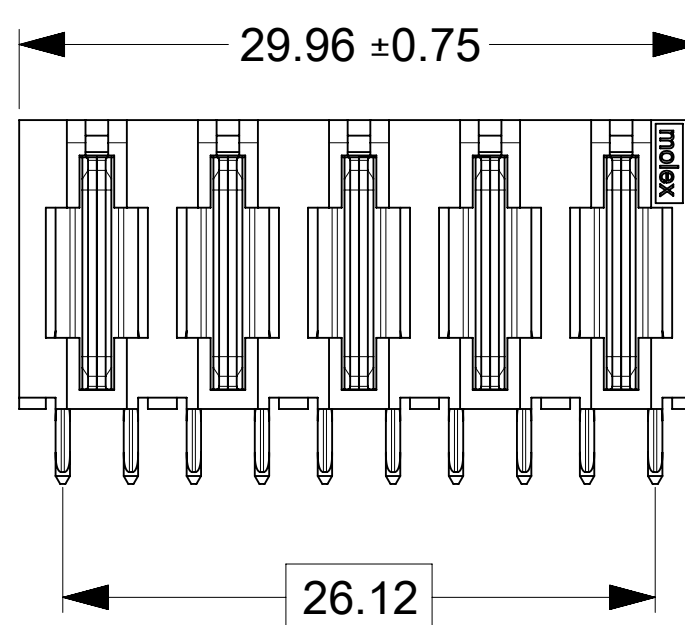

PART NUMBER	CONFIGURATION	QUANTITY PER CARTON (DU)
219562-0036	6P	112

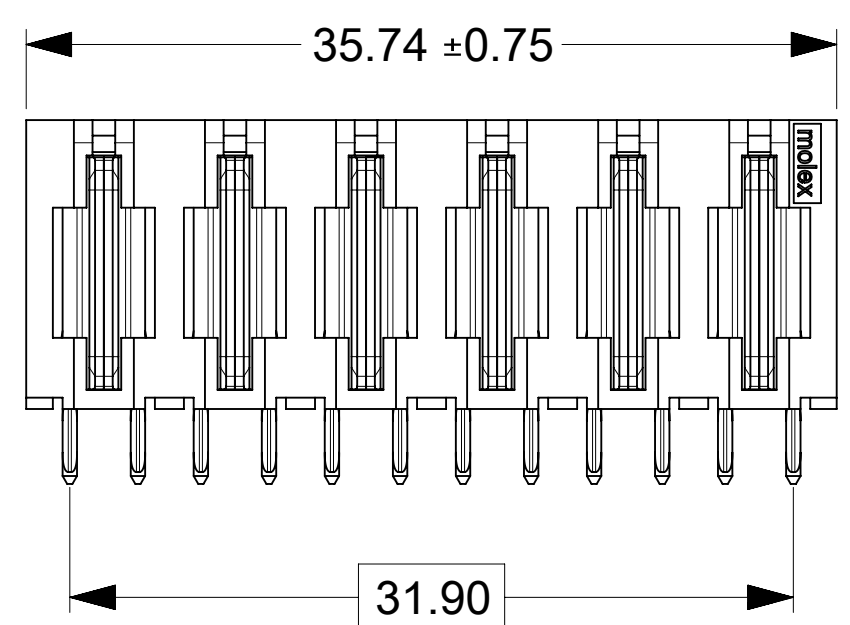

PART NUMBER	CONFIGURATION	QUANTITY PER CARTON (DU)
219562-0037	7P	96

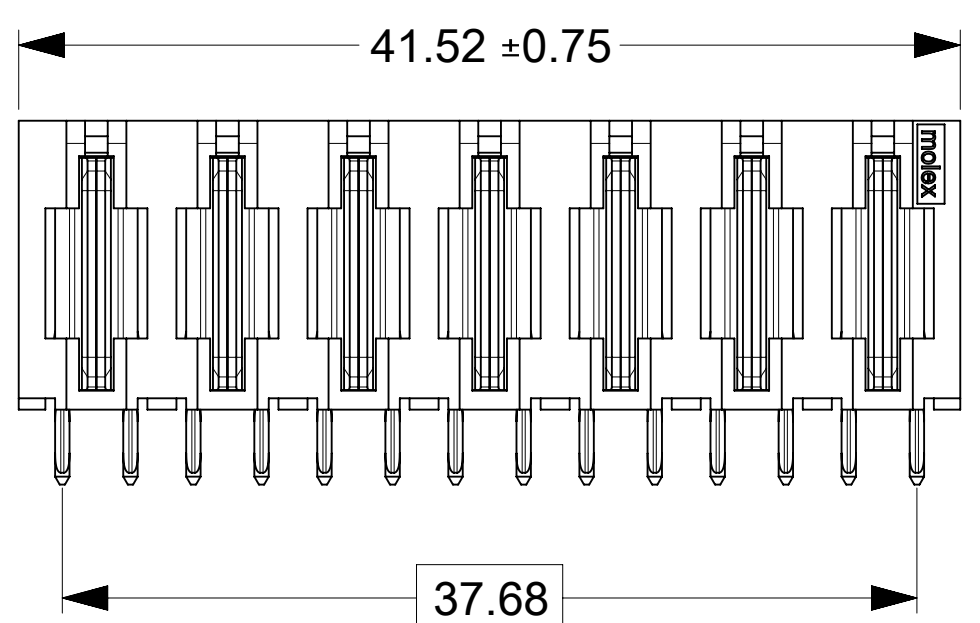

PART NUMBER	CONFIGURATION	QUANTITY PER CARTON (DU)
219562-0038	8P	96

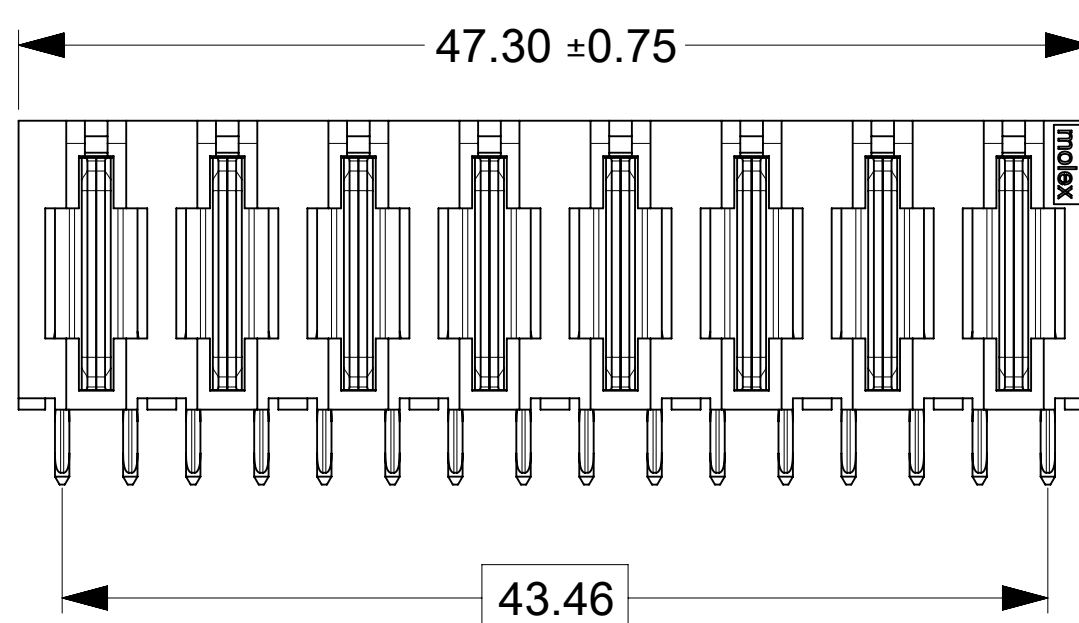

PART NUMBER	CONFIGURATION	QUANTITY PER CARTON (DU)
219562-0039	9P	80

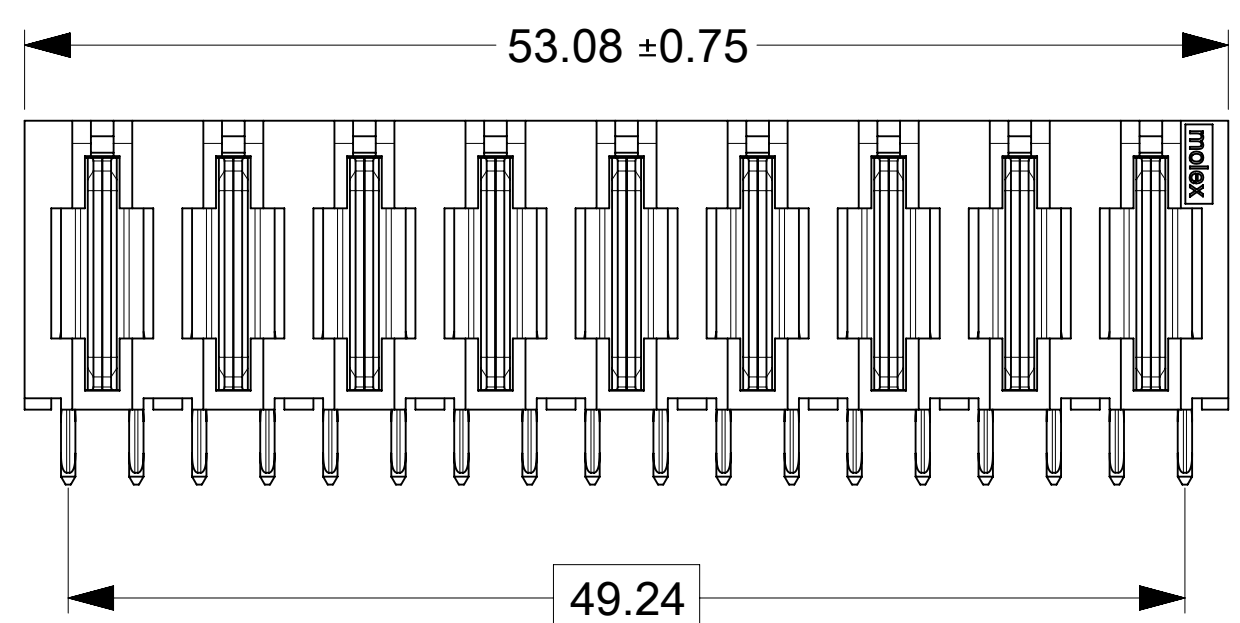

PART NUMBER	CONFIGURATION	QUANTITY PER CARTON (DU)
219562-0040	10P	64

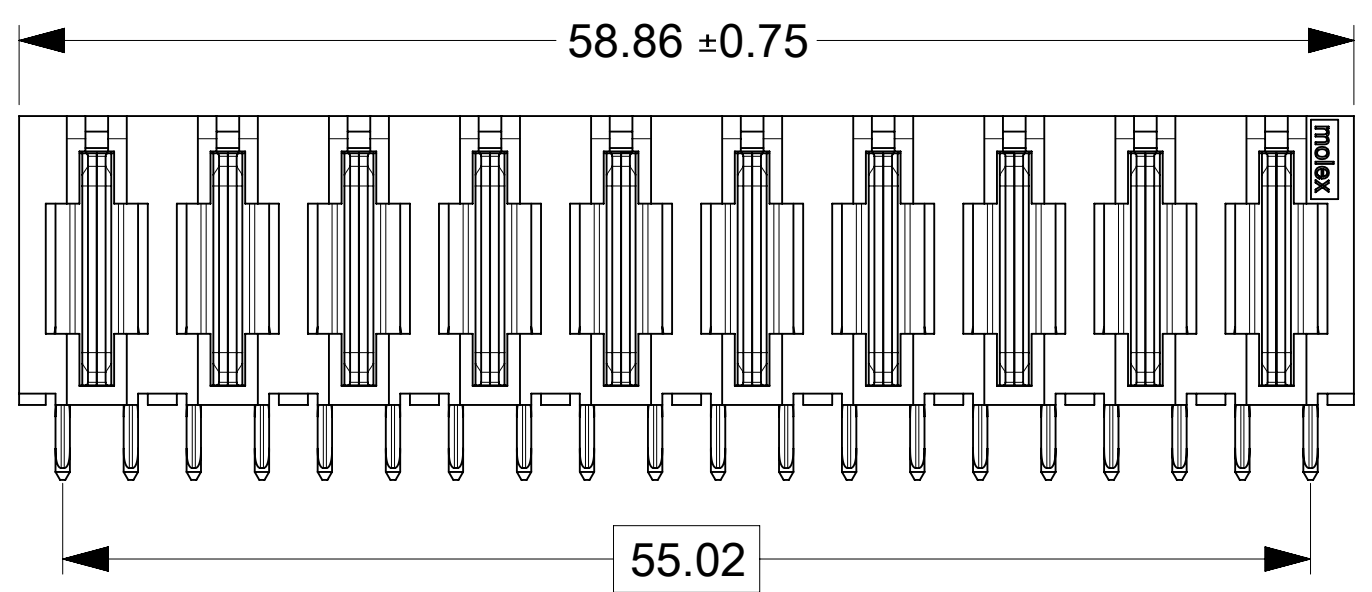

THIS DRAWING CONTAINS INFORMATION THAT IS PROPRIETARY TO MOLEX ELECTRONIC TECHNOLOGIES, LLC AND SHOULD NOT BE USED WITHOUT WRITTEN PERMISSION

DIMENSION UNITS	SCALE	CURRENT REV DESC:	
mm	3:1		
GENERAL TOLERANCES (UNLESS SPECIFIED)			
ANGULAR TOL	±	°	
4 PLACES	±		
3 PLACES	±		
2 PLACES	±	0.25	
1 PLACE	±	0.3	
0 PLACES	±		
DRAFT WHERE APPLICABLE MUST REMAIN WITHIN DIMENSIONS		THIRD ANGLE PROJECTION	DRAWING
			D-SIZE
		SERIES	MATERIAL NUMBER
		219562	SEE CHART
		CUSTOMER	SHEET NUMBER
			2 OF 2

molex

GUARDIAN HD RA PLUG POWER ONLY
UNGUIDED PF

PRODUCT CUSTOMER DRAWING

DOCUMENT NUMBER	DOC TYPE	DOC PART	REVISION
2195629003-SD	PSD	000	A1