

- Precision UHF SAW Filter
- 3.0 X 3.0 X 1.2 mm Surface-mount Case
- Differential Input and Output
- Complies with Directive 2002/95/EC (RoHS)

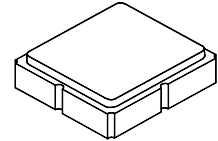

SF2079E

**251.045 MHz
SAW Filter**



SM3030-8

Absolute Maximum Ratings

Rating	Value	Units
Maximum Incident Power in Passband	+10	dBm
DC Voltage on any Non-ground Terminal	30	VDC
Operating Temperature Range	-40 to +85	°C
Component Storage Temperature Range	-60 to +95	°C
Suitable for Lead-free Soldering - Maximum Soldering Profile	260 °C for 30 s	

Electrical Characteristics

Characteristic	Sym	Notes	Min	Typ	Max	Units
Center Frequency	f_C	1		251.045		MHz
Insertion Loss	IL			12.5	15.0	dB
Amplitude Ripple:						
(fc - 6.2500) to (fc - 4.3925) MHz		1, 2		1.3	2.0	dB _{p-p}
(fc - 4.3925) to (fc - 2.5350) MHz			0.5	1.5		
(fc - 2.5350) to (fc - 0.0250) MHz			0.5	1.5		
(fc + 0.0250) to (fc + 2.5350) MHz			0.7	1.5		
(fc + 2.5350) to (fc + 4.3925) MHz			0.6	1.5		
(fc + 4.3925) to (fc + 6.2500) MHz			0.9	2.5		
1.5 dB Bandwidth centered at fc				13.4		MHz
3.0 dB Bandwidth centered at fc				14.1		
Low Side Attenuation < fc - 16.5 MHz			35	38		dB
Low Side Attenuation, 234.545 to 240.545 MHz (fc - 10.5 MHz)			32	34		
High Side Attenuation, 260.045 to 267.545 MHz (fc + 9.0 MHz)			14	26		
High Side Attenuation > fc + 16.5 MHz			30	35		
Temperature Coefficient of frequency					-18	ppm/K
Group Delay Ripple:						
(fc - 6.2500) to (fc - 4.3925) MHz		1, 2, 3		44	90	ns _{p-p}
(fc - 4.3925) to (fc - 2.5350) MHz			37	70		
(fc - 2.5350) to (fc - 0.0250) MHz			39	120		
(fc + 0.0250) to (fc + 2.5350) MHz			40	120		
(fc + 2.5350) to (fc + 4.3925) MHz			34	70		
(fc + 4.3925) to (fc + 6.2500) MHz			37	90		
Source/Load Impedance				150		ohms
Case Style		6	SM3030-8 3.0 x 3.0 mm Nominal Footprint			
Lid Symbolization (YY=year, WW=week, S=shift) See note 4			829 YWWS			



CAUTION: Electrostatic Sensitive Device. Observe precautions for handling.

NOTES:

1. Unless noted otherwise, all specifications apply over the operating temperature range with filter soldered to the specified demonstration board with impedance matching to 50 Ω and measured with 50 Ω network analyzer.
2. Unless noted otherwise, all frequency specifications are referenced to the nominal center frequency, fc.
3. Rejection is measured as attenuation below the minimum IL point in the passband. Rejection in final user application is dependent on PCB layout

4. and external impedance matching design. See Application Note No. 42 for details.
4. The design, manufacturing process, and specifications of this filter are subject to change.
5. Tape and Reel Standard Per ANSI / EIA 481.
6. US and international patents may apply.
7. Murata, stylized Murata logo, and Murata N.A., Inc. are registered trademarks of Murata Manufacturing Co., Ltd.

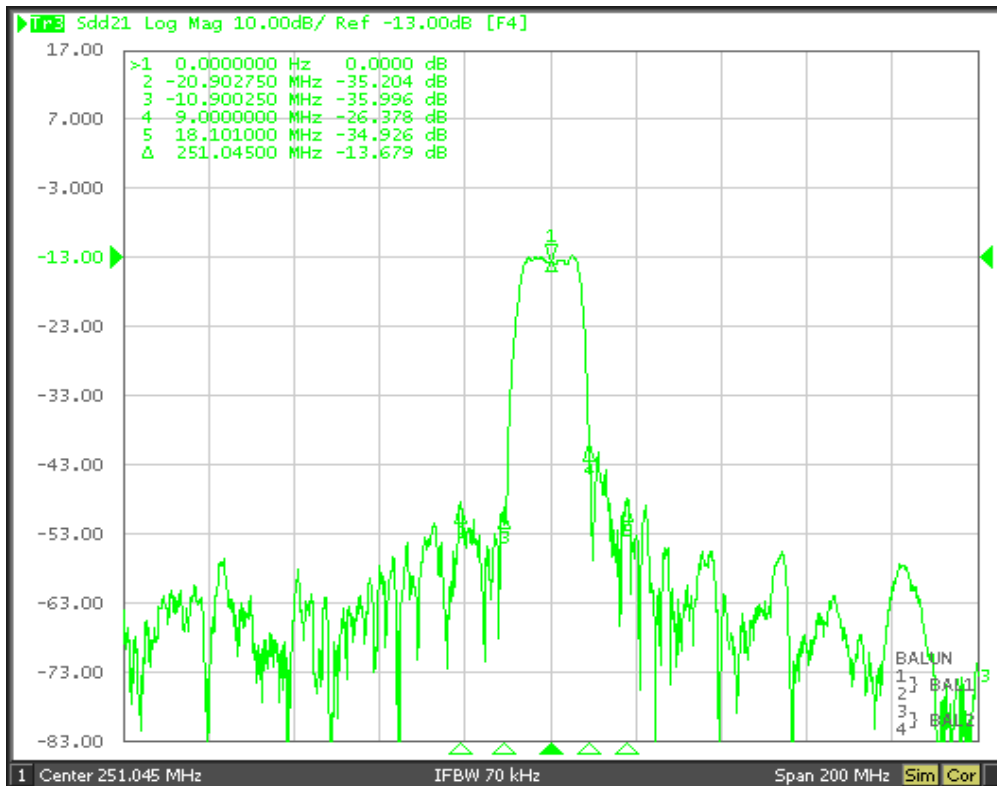
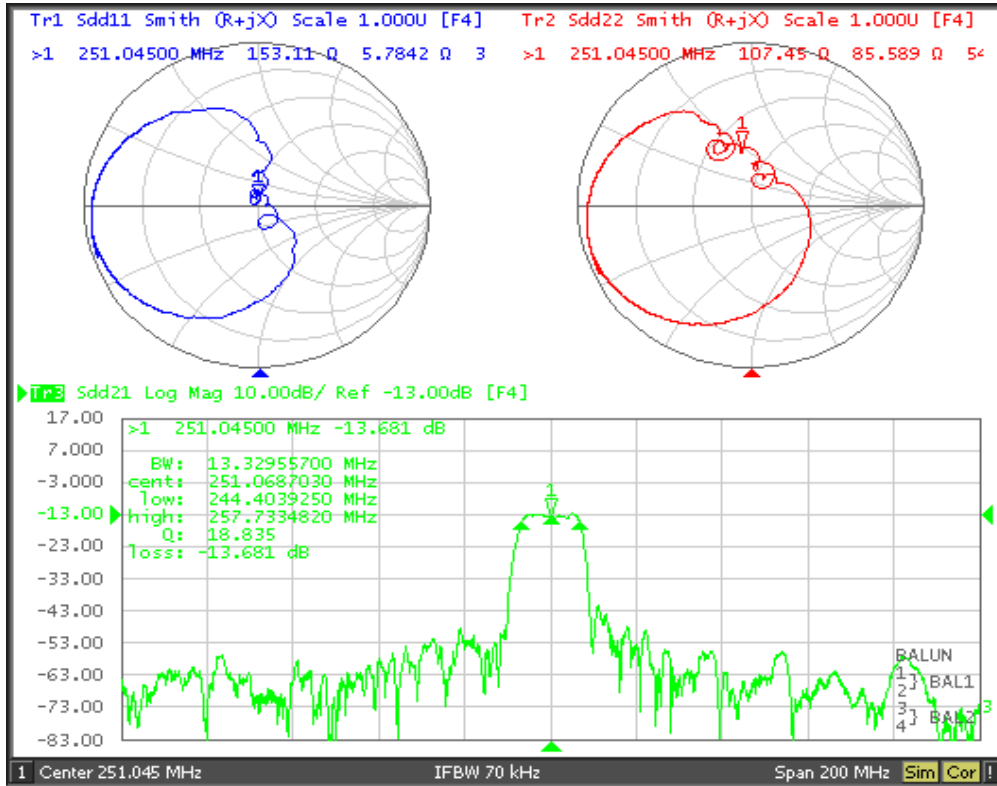

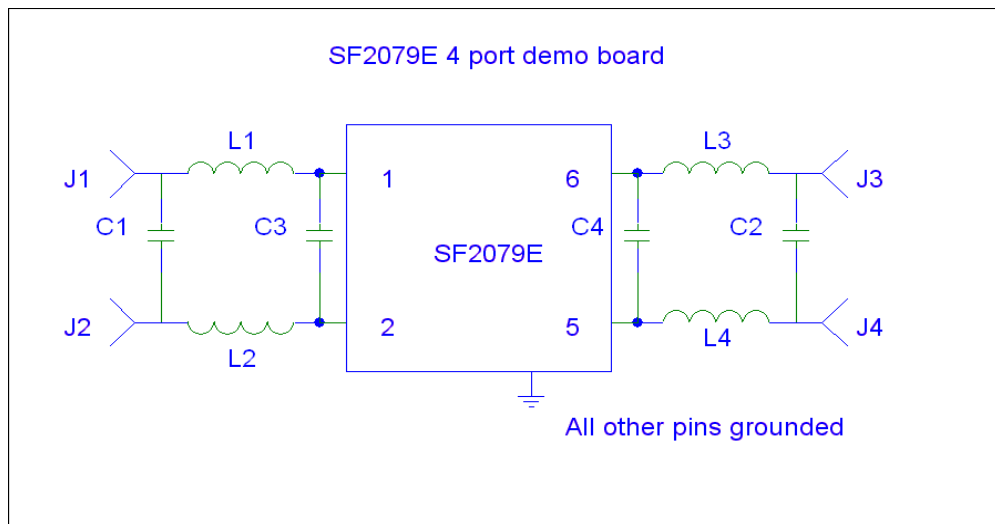
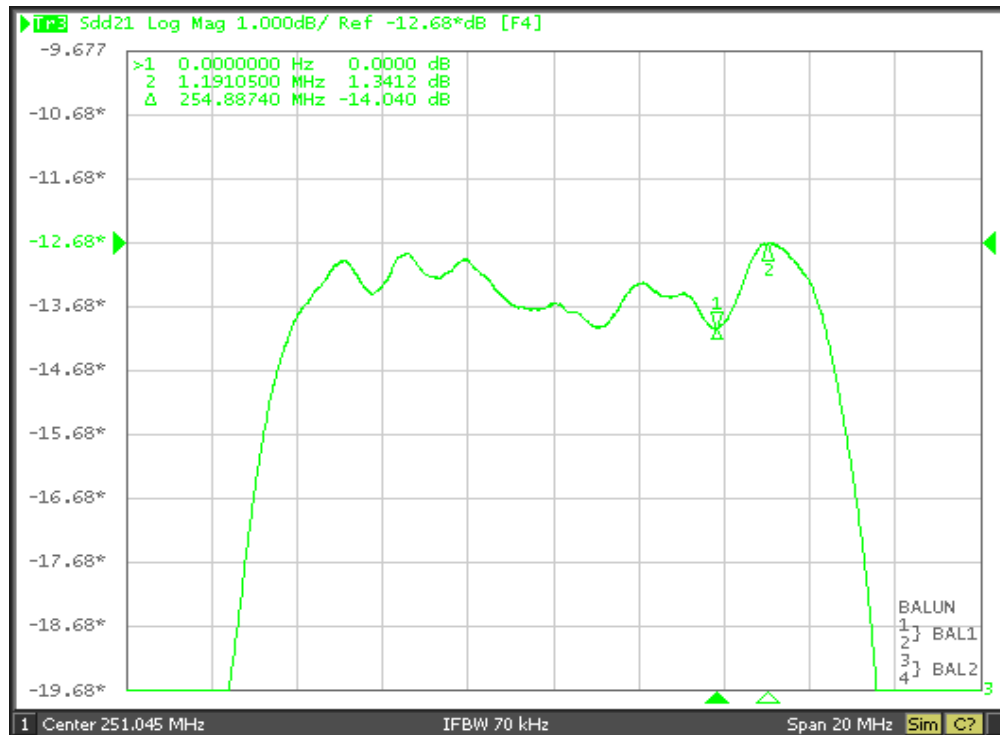

PCB	401-1724-001	PCB, DEMO, 3.0 or 3.8 PKG, PINS 1&2 IN, 5&6 OUT
J1,J2,J3,J4	500-1279-001	CONNECTOR, SMA FEMALE, END LAUNCH, 062" THICK PCB
L1,L2	501-1068-390	INDUCTOR, CHIP, 39 nH 0603
L3,L4	501-1068-470	INDUCTOR, CHIP, 47 nH 0603
C1	501-0857-150	CAPACITOR, CHIP, 15 pF 0402
C2	501-0857-120	CAPACITOR, CHIP, 12 pF 0402
C3	501-0857-010	CAPACITOR, CHIP, 1.0 pF 0402
C4	501-0857-005	CAPACITOR, CHIP, 0.5 pF 0402

8-Terminal Ceramic Surface-Mount Case 3.0 X 3.0 mm Nominal Footprint

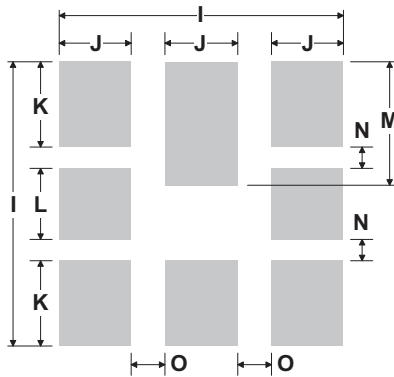
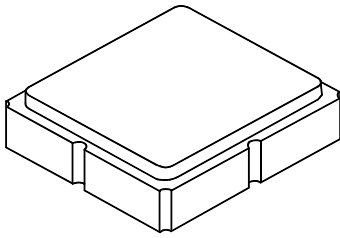

PCB Footprint Top View

Case and PCB Footprint Dimensions

Dimension	mm			Inches		
	Min	Nom	Max	Min	Nom	Max
A	2.87	3.0	3.13	0.113	0.118	0.123
B	2.87	3.0	3.13	0.113	0.118	0.123
C	1.14	1.27	1.40	0.045	0.050	0.055
D	0.79	0.92	1.05	0.031	0.036	0.041
E	0.62	0.75	0.88	0.024	0.029	0.034
F	0.47	0.60	0.73	0.018	0.024	0.029
G	0.47	0.60	0.73	0.018	0.024	0.029
H	1.07	1.20	1.33	0.042	0.047	0.052
I		3.19			0.126	
J		0.81			0.032	
K		0.96			0.038	
L		0.81			0.032	
M		1.39			0.055	
N		0.23			0.009	
O		0.38			0.015	

Case Materials

Materials	
Solder Pad Plating	0.3 to 1.0 μm Gold over 1.27 to 8.89 μm Nickel
Lid Plating	2.0 to 3.0 μm Nickel
Body	Al_2O_3 Ceramic
	Pb Free

TOP VIEW

BOTTOM VIEW

