



MCON Interconnection System

TE Internal #: 1-1924067-4

Housing for Female Terminals, Wire-to-Device / Wire-to-Board / Wire-to-Wire, 2 Position, .157 in [4 mm] Centerline, MCON Interconnection System

[View on TE.com >](#)

Connectors > Automotive Connectors > Automotive Housings



Connector System: **Wire-to-Board, Wire-to-Device, Wire-to-Wire**

Number of Positions: **2**

Connector & Housing Type: **Housing for Female Terminals**

Centerline (Pitch): **4 mm [.157 in]**

Sealable: **Yes**

Features

Product Type Features

Hybrid Connector	No
Connector Shape	Rectangular
Connector System	Wire-to-Board, Wire-to-Device, Wire-to-Wire
Connector & Housing Type	Housing for Female Terminals
Sealable	Yes
Primary Locking Feature	Integrated in Housing

Configuration Features

Number of Positions	2
Number of Rows	1

Body Features

Primary Product Color	Black
Connector & Keying Code	A

Contact Features

Contact Size	1.2mm
Contact Type	Receptacle
Mating Tab Width	1.2 mm[.047 in]

Mechanical Attachment

Terminal Position Assurance	Yes
Strain Relief	Without
Mating Alignment Type	Keyed
Mating Alignment	With
Connector Mounting Type	Cable Mount (Free-Hanging)

Housing Features

Housing Material	PA GF
Centerline (Pitch)	4 mm [.157 in]

Dimensions

Connector Height	15.8 mm [.622 in]
Product Width	26.5 mm [1.043 in]
Product Length	15 mm [.591 in]

Usage Conditions

Operating Temperature (Max)	70 °C, 75 °C, 80 °C, 85 °C, 90 °C, 100 °C, 105 °C, 110 °C, 120 °C, 125 °C [158 °F][167 °F][176 °F][185 °F][194 °F][212 °F][221 °F][230 °F][248 °F][257 °F]
Operating Temperature Range	-40 – 125 °C [-40 – 257 °F]

Operation/Application

Circuit Application	Signal
---------------------	--------

Industry Standards

Degree of Protection	IP67
----------------------	------

Other

Serviceable	Yes
Connector Position Assurance Capable	Yes

Product Compliance

[For compliance documentation, visit the product page on TE.com>](#)

EU RoHS Directive 2011/65/EU	Compliant
EU ELV Directive 2000/53/EC	Compliant
China RoHS 2 Directive MIIT Order No 32, 2016	No Restricted Materials Above Threshold
EU REACH Regulation (EC) No. 1907/2006	Current ECHA Candidate List: JUNE 2023 (235)



Candidate List Declared Against: JUNE 2023 (235)
Does not contain REACH SVHC

Halogen Content	Low Halogen - Br, Cl, F, I < 900 ppm per homogenous material. Also BFR/CFR/PVC Free
Solder Process Capability	Not applicable for solder process capability

Product Compliance Disclaimer

This information is provided based on reasonable inquiry of our suppliers and represents our current actual knowledge based on the information they provided. This information is subject to change. The part numbers that TE has identified as EU RoHS compliant have a maximum concentration of 0.1% by weight in homogenous materials for lead, hexavalent chromium, mercury, PBB, PBDE, DBP, BBP, DEHP, DIBP, and 0.01% for cadmium, or qualify for an exemption to these limits as defined in the Annexes of Directive 2011/65/EU (RoHS2). Finished electrical and electronic equipment products will be CE marked as required by Directive 2011/65/EU. Components may not be CE marked. Additionally, the part numbers that TE has identified as EU ELV compliant have a maximum concentration of 0.1% by weight in homogenous materials for lead, hexavalent chromium, and mercury, and 0.01% for cadmium, or qualify for an exemption to these limits as defined in the Annexes of Directive 2000/53/EC (ELV). Regarding the REACH Regulation, the information TE provides on SVHC in articles for this part number is based on the latest European Chemicals Agency (ECHA) 'Guidance on requirements for substances in articles' posted at this URL: <https://echa.europa.eu/guidance-documents/guidance-on-reach>

Compatible Parts



Also in the Series | MCON Interconnection System

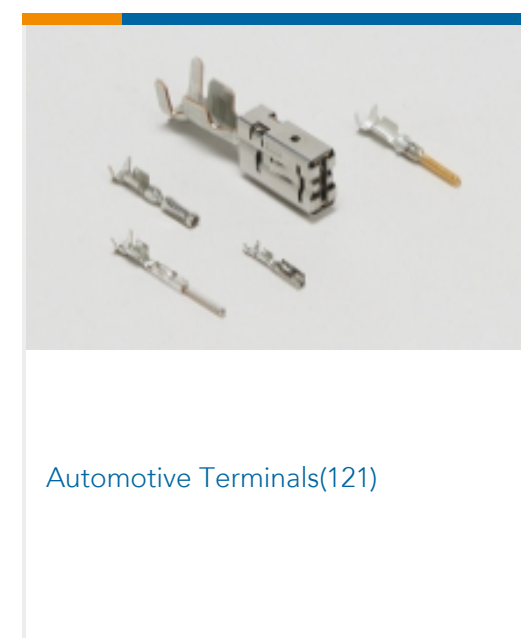
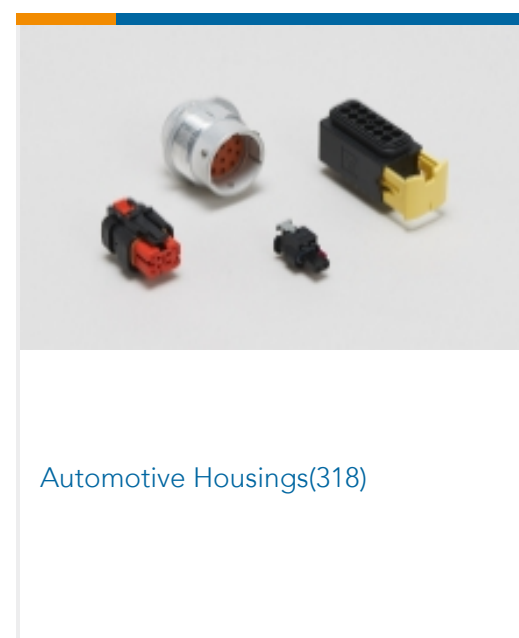
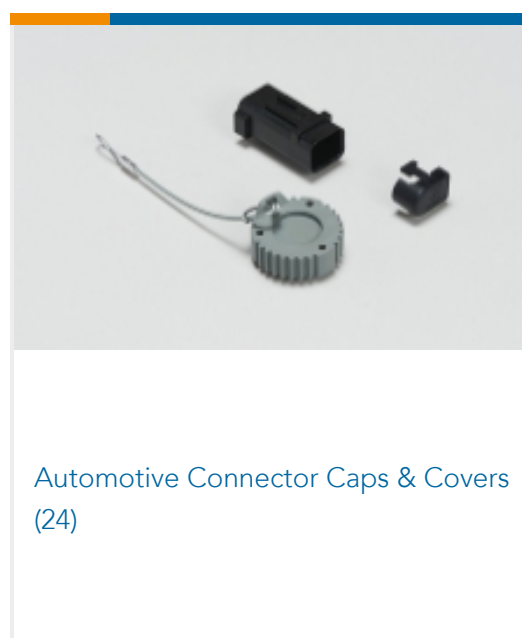

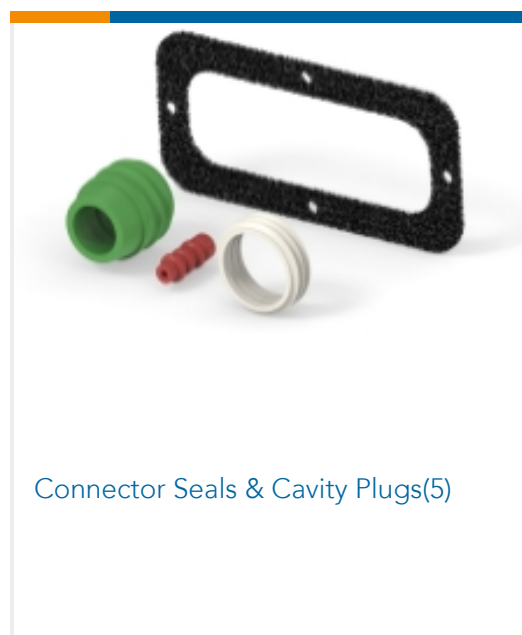

Connector Seals & Cavity Plugs(5)

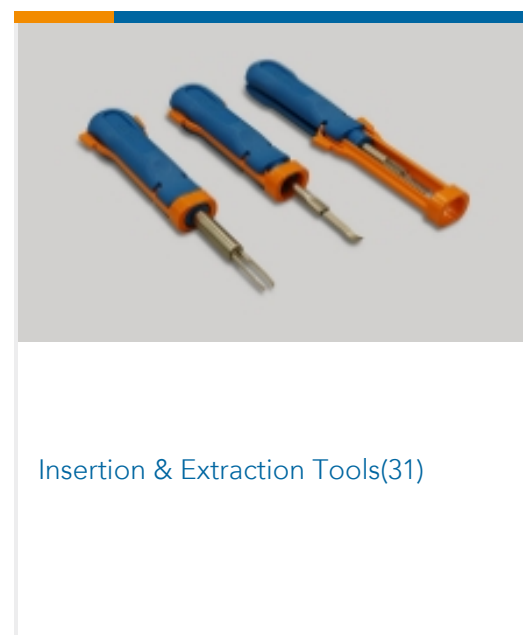

Insertion & Extraction Tools(31)

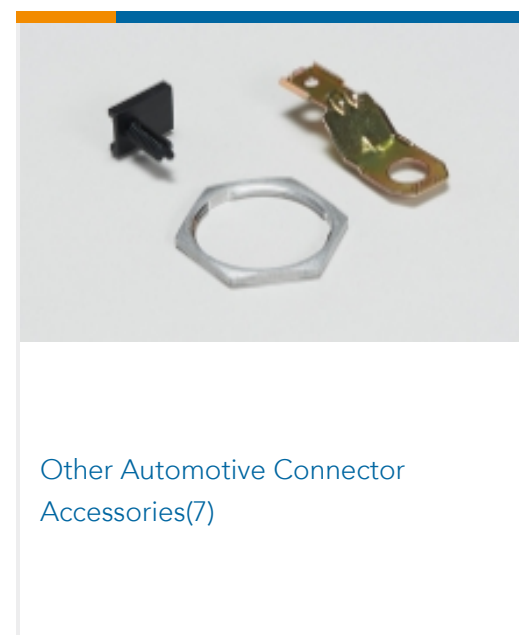

Other Automotive Connector Accessories(7)



PCB Headers & Receptacles(1)

Customers Also Bought

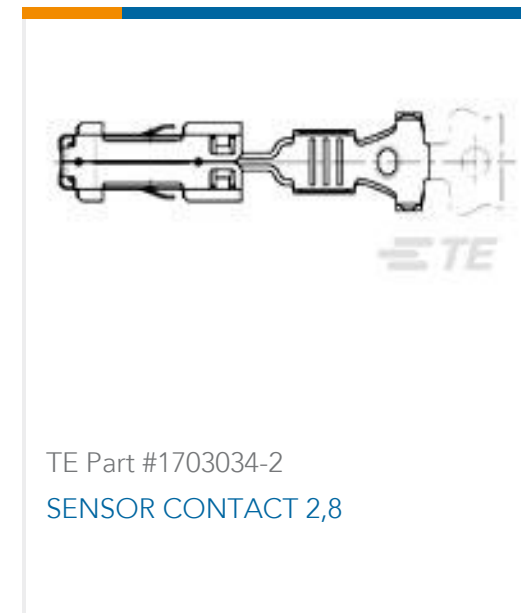
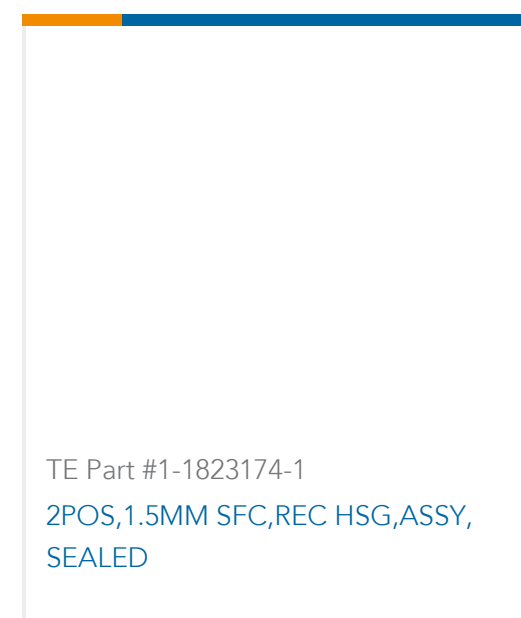
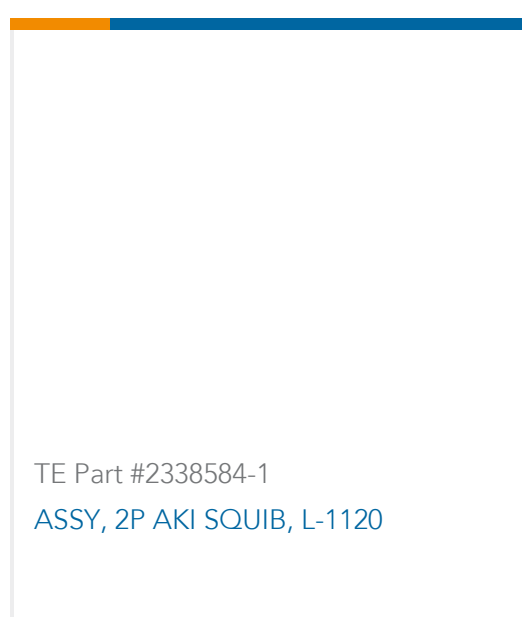
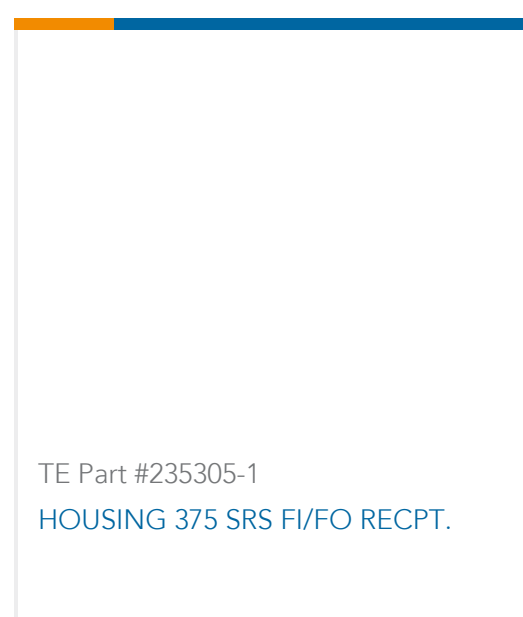
TE Part #927871-1
JUNIOR-TIMER KONTTE Part #6-1355683-3
MT3BU-GEH ASSY6P,SWTE Part #1379671-5
40W PLUG HSG ASSY NATURALTE Part #1703034-2
SENSOR CONTACT 2,8TE Part #2137299-8
PACKAGE COMPONENT FOR 32P
MIXETE Part #2236047-1
32POS,MIXED,RECEPTACLE
CONNECTOR,COD ATE Part #EF74056001
RBK-ILS-125-3A-0-45MMTE Part #1-1823174-1
2POS,1.5MM SFC,REC HSG,ASSY,
SEALEDTE Part #2338584-1
ASSY, 2P AKI SQUIB, L-1120TE Part #235305-1
HOUSING 375 SRS FI/FO RECPT.

Documents

Product Drawings

[2POS, MCON 1.2 CB REC 2p TL SEALED](#)

English

CAD Files

[Customer View Model](#)

[ENG_CVM_CVM_1-1924067-4_C.2d_dxf.zip](#)

English

[3D PDF](#)



3D

Customer View Model

[ENG_CVM_CVM_1-1924067-4_C.3d_igs.zip](#)

English

Customer View Model

[ENG_CVM_CVM_1-1924067-4_C.3d_stp.zip](#)

English

By downloading the CAD file I accept and agree to the [Terms and Conditions](#) of use.

Datasheets & Catalog Pages

[MCON Interconnection System](#)

English

Product Environmental Compliance

[Product Compliance](#)

English

[Product Compliance](#)

English

Instruction Sheets

[Instruction Sheet \(U.S.\)](#)

English

[Instruction Sheet \(U.S.\)](#)

English