

600 V, 60 A ultrafast high voltage rectifier

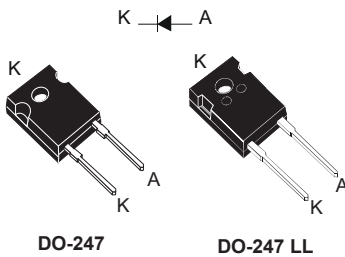

Features

- High junction temperature capability
- Ultrafast with soft recovery behavior
- Low reverse current
- Low thermal resistance
- Reduced switching and conduction losses
- **ECOPACK2** compliant component

Description

The **STTH60RQ06** has been developed for applications requiring a high-voltage (HV) capability such as in secondary rectification in HV LLC full bridge topology or in high voltage boost function.

It is ideal for switching power supplies and industrial applications, as rectification function, or even freewheeling and clamping diode.

Product status link	
STTH60RQ06	
Product summary	
Symbol	Value
$I_{F(AV)}$	60 A
V_{RRM}	600 V
$V_F(max.)$	1.45 V
$t_{rr}(max.)$	35 ns
$T_j(max.)$	175 °C

1 Characteristics

Table 1. Absolute ratings (limiting values at 25 °C, unless otherwise specified)

Symbol	Parameter	Value	Unit	
V_{RRM}	Repetitive peak reverse voltage	600	V	
$I_{F(RMS)}$	Forward rms current	DO-247	90	A
		DO-247 LL	80	
$I_{F(AV)}$	Average forward current	$T_C = 115\text{ °C}$, $\delta = 0.5$ square	60	A
I_{FSM}	Surge non repetitive forward current	$t_p = 10$ ms sinusoidal	425	A
T_{stg}	Storage temperature range	-65 to +175	°C	
T_j	Maximum operating junction temperature	175	°C	

Table 2. Thermal resistance parameters

Symbol	Parameter	Max.	Unit
$R_{th(j-c)}$	Junction to case	0.38	°C/W

For more information, please refer to the following application note:

- AN5088: Rectifiers thermal management, handling and mounting recommendations

Table 3. Static electrical characteristics

Symbol	Parameter	Test conditions		Min.	Typ.	Max.	Unit
$I_R^{(1)}$	Reverse leakage current	$T_j = 25\text{ °C}$	$V_R = V_{RRM}$	-		80	μA
		$T_j = 150\text{ °C}$		-	160	1600	
$V_F^{(2)}$	Forward voltage drop	$T_j = 25\text{ °C}$	$I_F = 30\text{ A}$	-		2.45	V
		$T_j = 150\text{ °C}$		-	1.15	1.45	
		$T_j = 25\text{ °C}$	$I_F = 60\text{ A}$	-		2.95	
		$T_j = 150\text{ °C}$		-	1.45	1.85	

1. Pulse test: $t_p = 5\text{ ms}$, $\delta < 2\%$

2. Pulse test: $t_p = 380\text{ }\mu\text{s}$, $\delta < 2\%$

To evaluate the conduction losses, use the following equation:

$$P = 1.05 \times I_{F(AV)} + 0.013 \times I_{F(RMS)}^2$$

For more information, please refer to the following application notes related to the power losses:

- AN604: Calculation of conduction losses in a power rectifier
- AN4021: Calculation of reverse losses on a power diode
- AN5028: Calculation of turn-off power losses generated by an ultrafast diode

Table 4. Dynamic electrical characteristics

Symbol	Parameter	Test conditions		Min.	Typ.	Max.	Unit
t_{rr}	Reverse recovery time	$T_j = 25\text{ °C}$	$I_F = 0.5\text{ A}, I_{rr} = 0.25\text{ A}, I_R = 1\text{ A}$	-		35	ns
			$I_F = 1\text{ A}, V_R = 30\text{ V}, dI_F/dt = -50\text{ A}/\mu\text{s}$	-	50	65	
I_{RM}	Reverse recovery current	$T_j = 125\text{ °C}$	$I_F = 60\text{ A}, V_R = 400\text{ V}, dI_F/dt = -200\text{ A}/\mu\text{s}$	-	12	16	A
Q_{rr}	Reverse recovery charge			-	660		nC
t_{rr}	Reverse recovery time			-	92		ns

1.1 Characteristics (curves)

Figure 1. Average forward power dissipation versus average forward current (square waveform, DO-247)

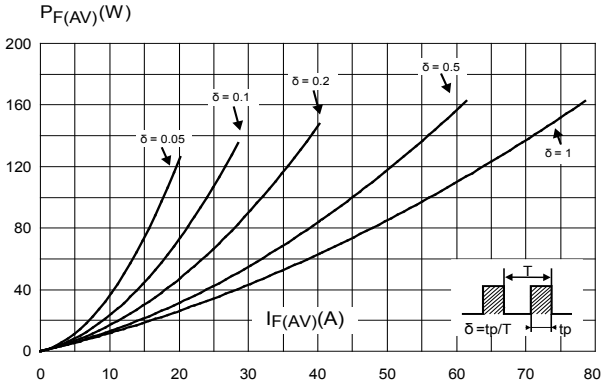

Figure 2. Average forward power dissipation versus average forward current (sinusoidal waveform, DO-247)

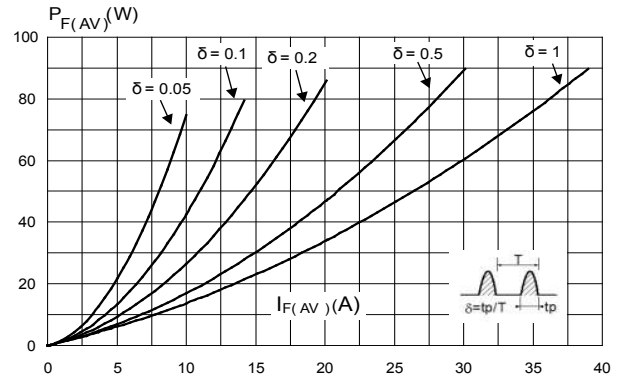

Figure 3. Average forward power dissipation versus average forward current (square waveform, DO-247 LL)

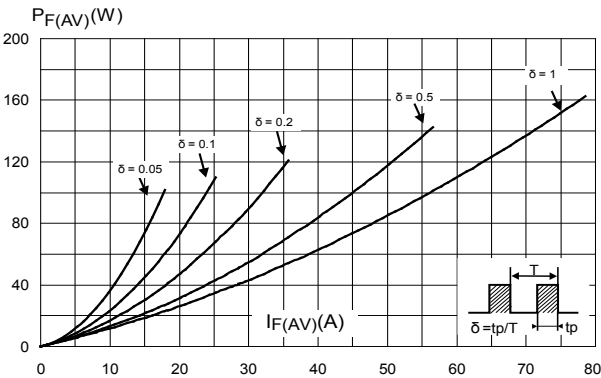

Figure 4. Average forward power dissipation versus average forward current (sinusoidal waveform, DO-247 LL)

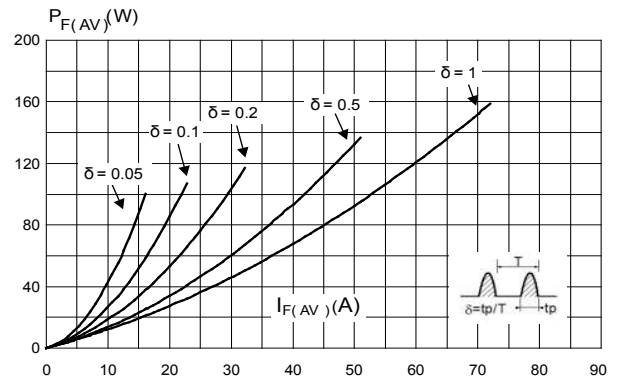

Figure 5. Forward voltage drop versus forward current (typical values)

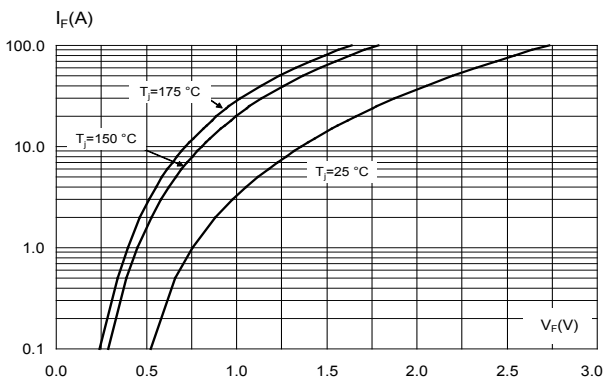

Figure 6. Forward voltage drop versus forward current (maximum values)

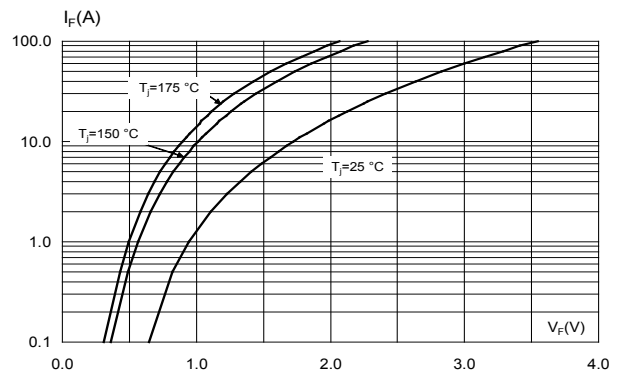

Figure 7. Relative variation of thermal impedance junction to case versus pulse duration

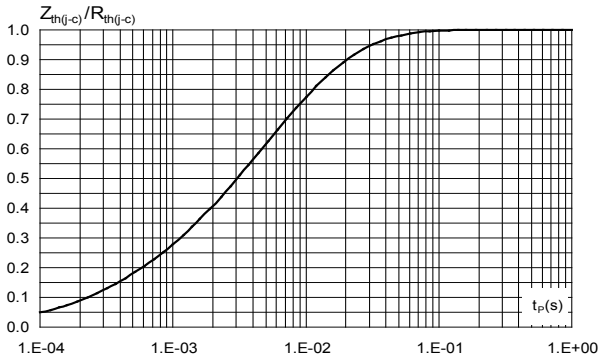

Figure 8. Peak reverse recovery current versus di_F/dt (typical values)

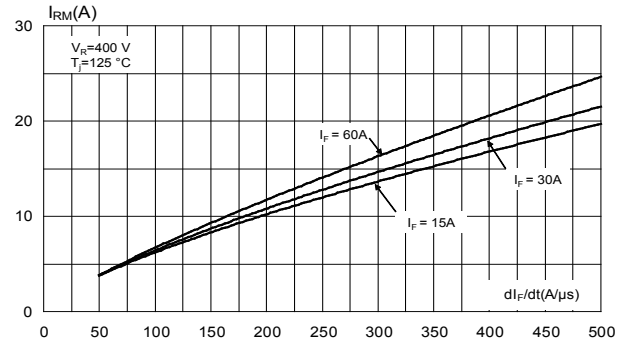

Figure 9. Reverse recovery time versus di_F/dt (typical values)

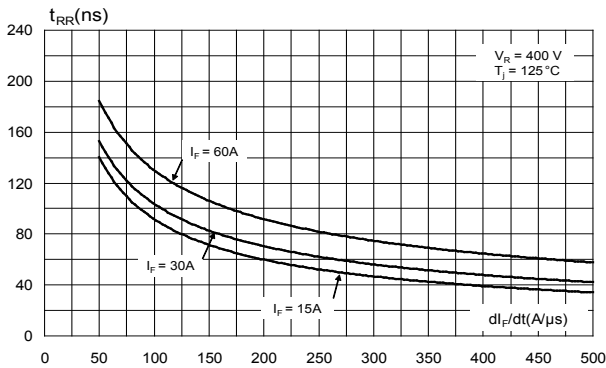

Figure 10. Reverse recovery charges versus di_F/dt (typical values)

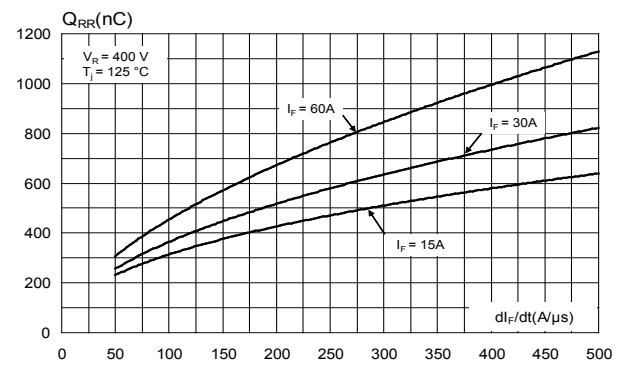

Figure 11. Reverse recovery softness factor versus di_F/dt (typical values)

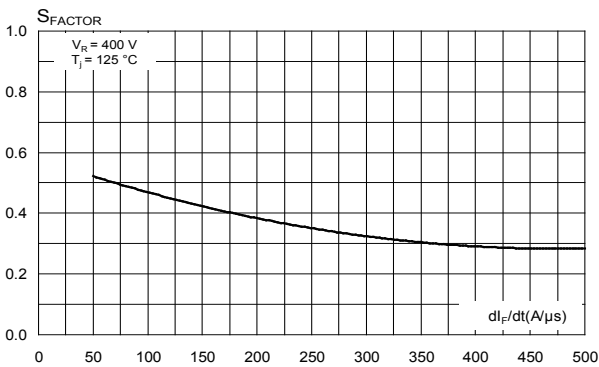

Figure 12. Relative variations of dynamic parameters versus junction temperature

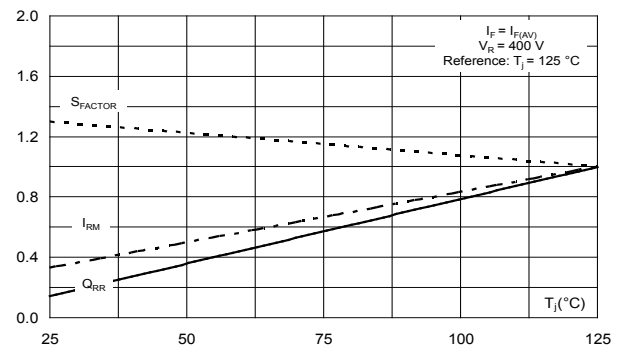

Figure 13. Junction capacitance versus reverse voltage applied (typical values)

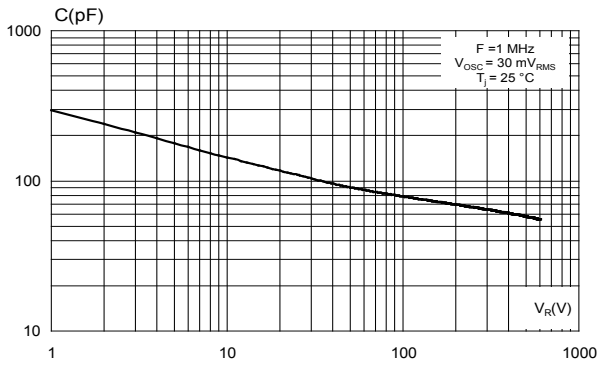

Figure 14. Relative variation of non-repetitive peak surge forward current versus pulse duration (sinusoidal waveform)

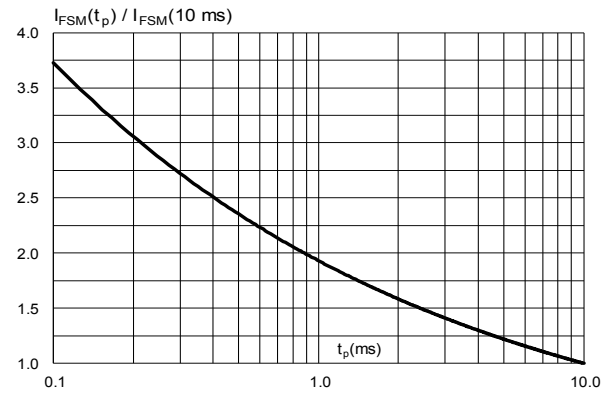
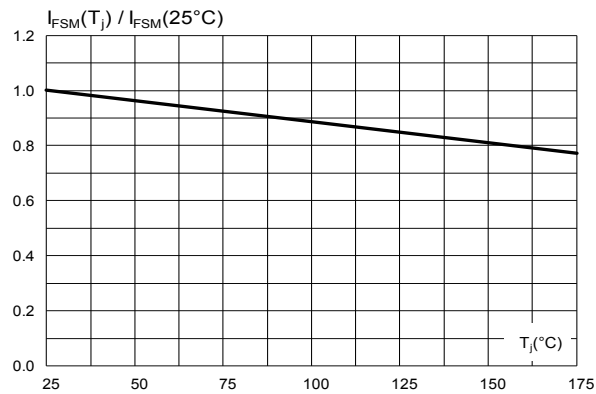

Figure 15. Relative variation of non-repetitive peak surge forward current versus initial junction temperature (sinusoidal waveform)



2 Package information

In order to meet environmental requirements, ST offers these devices in different grades of **ECOPACK** packages, depending on their level of environmental compliance. ECOPACK specifications, grade definitions and product status are available at: www.st.com. ECOPACK is an ST trademark.

2.1 DO-247 package information

- Epoxy meets UL94, V0
- Cooling method: by conduction (C)
- Recommended torque value: 0.8 N·m (DO-247)
- Maximum torque value: 1.0 N·m (DO-247)

Figure 16. DO-247 package outline

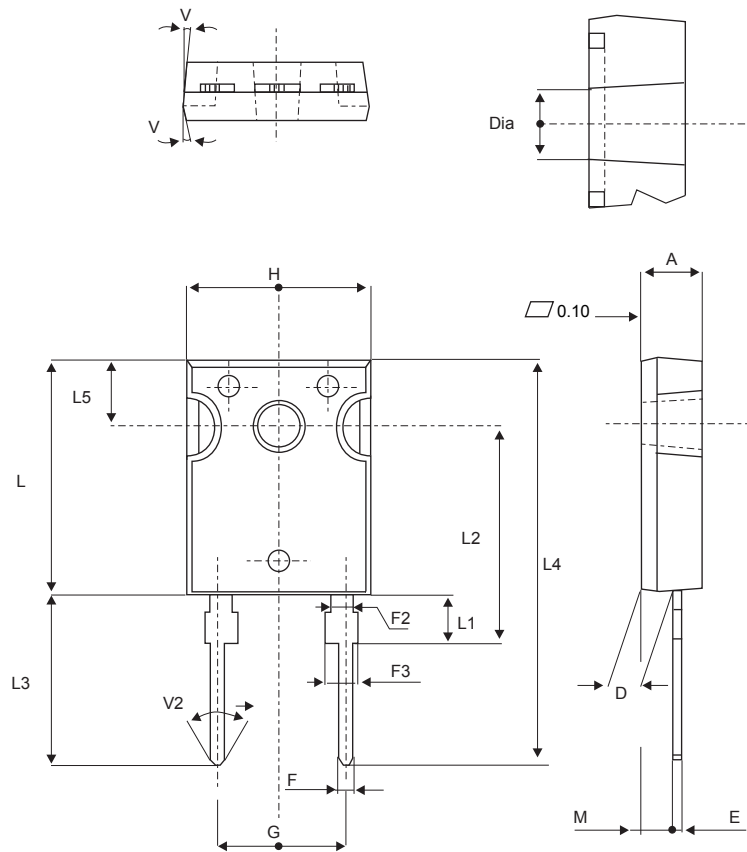

Table 5. DO-247 package mechanical data

Ref.	Dimensions			
	Millimeters		Inches	
	Min.	Max.	Min.	Max.
A	4.85	5.15	0.191	0.203
D	2.20	2.60	0.086	0.102
E	0.40	0.80	0.015	0.031
F	1.00	1.40	0.039	0.055
F2	2.00 typ.		0.078 typ.	
F3	2.00	2.40	0.078	0.094
G	10.90 typ.		0.429 typ.	
H	15.45	15.75	0.608	0.620
L	19.85	20.15	0.781	0.793
L1	3.70	4.30	0.145	0.169
L2	18.50 typ.		0.728 typ.	
L3	14.20	14.80	0.559	0.582
L4	34.60 typ.		1.362 typ.	
L5	5.50 typ.		0.216 typ.	
M	2.00	3.00	0.078	0.118
V	5°		5°	
V2	60°		60°	
Dia.	3.55	3.65	0.139	0.143

2.2 DO-247 LL package information

- Epoxy meets UL94, V0
- Cooling method: by conduction (C)
- Recommended torque value: 0.8 N·m
- Maximum torque value: 1.0 N·m

Figure 17. DO-247 LL package outline

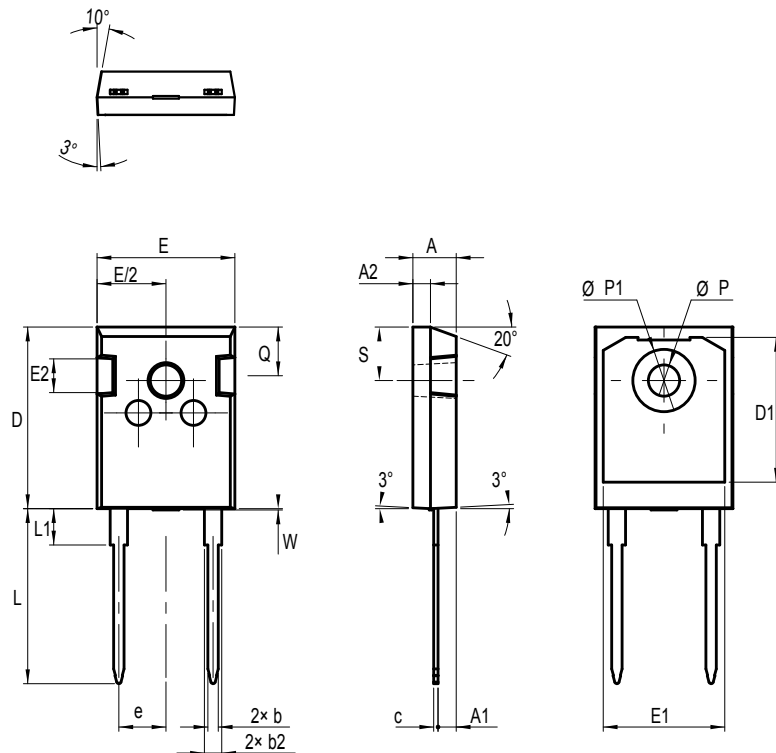

Table 6. DO-247 LL package mechanical data

Ref.	Dimensions			
	Millimeters		Inches (for reference only)	
	Min.	Max.	Min.	Max.
A	4.70	5.31	0.185	0.209
A1	2.21	2.59	0.087	0.102
A2	1.50	2.49	0.059	0.098
b	0.99	1.40	0.039	0.055
b2	1.65	2.39	0.065	0.094
c	0.38	0.89	0.015	0.035
D	20.80	21.46	0.819	0.845
D1	13.08		0.515	
E	15.49	16.26	0.610	0.640
e	5.44 typ.		0.214	
E1	13.46		0.530	
E2	3.43	3.99	0.135	0.157
L	19.81	20.32	0.780	0.800
L1		4.50		0.177
P	3.56	3.66	0.140	0.144
P1	7.06	7.39	0.278	0.291
Q	5.38	6.20	0.219	0.244
S	6.17 typ.		0.243	
W		0.15		0.006

3 Ordering information

Table 7. Ordering information

Order code	Marking	Package	Weight	Base qty.	Delivery mode
STTH60RQ06W	STTH60RQ06W	DO-247	4.40 g	30	Tube
STTH60RQ06WL	STTH60RQ06WL	DO-247 LL	5.90 g	30	Tube

Revision history

Table 8. Document revision history

Date	Version	Changes
03-Apr-2018	1	Initial release.
02-Mar-2020	2	Added DO-247 LL package information.
30-Mar-2020	3	Updated Figure 1 , Figure 2 , Figure 3 and Figure 4 .

IMPORTANT NOTICE – PLEASE READ CAREFULLY

STMicroelectronics NV and its subsidiaries (“ST”) reserve the right to make changes, corrections, enhancements, modifications, and improvements to ST products and/or to this document at any time without notice. Purchasers should obtain the latest relevant information on ST products before placing orders. ST products are sold pursuant to ST’s terms and conditions of sale in place at the time of order acknowledgement.

Purchasers are solely responsible for the choice, selection, and use of ST products and ST assumes no liability for application assistance or the design of Purchasers’ products.

No license, express or implied, to any intellectual property right is granted by ST herein.

Resale of ST products with provisions different from the information set forth herein shall void any warranty granted by ST for such product.

ST and the ST logo are trademarks of ST. For additional information about ST trademarks, please refer to www.st.com/trademarks. All other product or service names are the property of their respective owners.

Information in this document supersedes and replaces information previously supplied in any prior versions of this document.

© 2020 STMicroelectronics – All rights reserved