



IQS228D DATASHEET

Single Channel Capacitive Proximity and Touch Controller

The ProxSense® **IQS228D** is a single channel self-capacitive sensor with Dynamic Calibration (DYCAL™) to allow for sensor drift during prolonged activation.

Features

- > 1 Self capacitive channel
- > DYCAL™: Intelligent hysteresis
- > Proximity and Touch outputs
- > Automatic Tuning
- > Internal Reference Capacitor
- > Minimum external components
- > 1-Wire data streaming
- > I²C Debug option
- > User selectable options (OTP)
- > I/O Sink or Source selection
- > Time-out for stuck key
- > Proximity and Touch sensitivity selections
- > Low Power Mode - 3.2 μA
- > Supply voltage: 2.4 V to 5 V



RoHS2
Compliant

6 pin DFN-6
Representation only, not
actual markings

Applications

- > Proximity sensors
- > On-ear detection for mobile phones
- > Personal Media Players
- > Human Interface Devices
- > SAR detection for Tablets
- > 3D glasses
- > White goods and appliances
- > Proximity activated backlighting

Available Options

| T _A | DFN-6 |
|----------------|---------|
| -40°C to 85°C | IQS228D |



Contents

| | |
|---|-----------|
| 1 Overview | 5 |
| 1.1 Device | 5 |
| 1.2 Operation | 5 |
| 1.3 Applicability | 5 |
| 2 Packaging and Pin-Out | 6 |
| 2.1 IQS228D | 6 |
| 2.1.1 Pin-out | 6 |
| 2.2 Schematic | 7 |
| 2.2.1 DFN-6 | 7 |
| 2.3 Recommended Capacitor Values | 8 |
| 2.4 Exception to recommended capacitor values | 8 |
| 3 User Configurable Options | 9 |
| 3.1 Configuring of Devices | 9 |
| 4 Measuring Capacitance Using the Charge Transfer Method | 12 |
| 5 DYCAL Operation | 13 |
| 6 Operating Principle | 14 |
| 7 Configurable Settings | 14 |
| 7.1 CTRL: External Control | 14 |
| 7.1.1 Charge Halt | 14 |
| 7.1.2 Halt LTA Filter | 14 |
| 7.1.3 Pulse on CTRL: | 15 |
| 7.2 LOGIC | 15 |
| 7.3 RF Noise on IQS228D | 15 |
| 7.3.1 IQS228D RF Noise Immunity | 15 |
| 7.4 Proximity Threshold | 16 |
| 7.5 Touch Threshold | 16 |
| 7.6 Multipliers | 17 |
| 7.7 Charge Transfer | 17 |
| 7.8 Target Counts | 17 |
| 7.9 Enable Partial ATI | 17 |
| 7.10 DYCAL TURBO | 18 |
| 7.11 Filter Halt | 18 |
| 7.12 Low Power Modes | 18 |
| 7.13 Zoom | 19 |
| 8 Streaming Mode | 20 |
| 8.1 Event Mode | 21 |
| 8.2 I2C | 22 |
| 9 Automatic Tuning Implementation (ATI) | 23 |
| 9.1 Full ATI | 23 |
| 9.2 ATI Target | 23 |
| 9.3 ATlbase: Significance of ATI Base | 23 |
| 9.4 Sensitivity Due to ATI | 24 |
| 9.5 ATI Procedure | 24 |



| | |
|---|-----------|
| 10 DYCAL Specific Settings | 26 |
| 10.1 Release Threshold | 26 |
| 10.2 Input Enable | 26 |
| 11 Electrical Specifications | 27 |
| 11.1 Absolute Maximum Specifications | 27 |
| 11.2 General Characteristics | 27 |
| 11.3 Output Characteristics | 27 |
| 11.4 Packaging Information | 28 |
| 11.4.1 DFN-6 | 28 |
| 11.4.2 MSL Level | 28 |
| 12 Datasheet and Part-number Information | 29 |
| 12.1 Ordering Information | 29 |
| 12.2 Device Marking - Top | 29 |
| 12.2.1 DFN-6 Package Markings | 29 |
| 12.2.2 Tape and Reel Specification | 30 |
| A Memory Map | 31 |



List of Abbreviations

| | |
|----------------|-------------------------------------|
| ATI | Automatic Tuning Implementation |
| BP | Boost Power Mode |
| CS | Counts (Number of Charge Transfers) |
| C _S | Internal Reference Capacitor |
| DYCAL™ | Dynamic Calibration |
| EMI | Electromagnetic Interference |
| ESD | Electro-Static Discharge |
| FTB/EFT | (Electrical) Fast Transient Bursts |
| GND | Ground |
| HC | Halt Charge |
| LP | Low Power Mode |
| LTA | Long Term Average |
| THR | Threshold |



1 Overview

1.1 Device

The IQS228D is a single channel capacitive proximity and touch device which employs an internal voltage regulator and reference capacitor (C_S).

The IQS228D device has a dedicated pin for the connection of a sense electrode (C_x) and output pin for proximity and touch events on **OUT**. The polarity of the output pins can be configured. A 1-wire open drain data streaming protocol or I²C interface is implemented for debugging purposes.

Special device configuration can be done by setting one time programmable (OTP) options.

The device automatically tracks slow varying environmental changes via various signal processing algorithms and has an Automatic Tuning Implementation (ATI) algorithm to calibrate the device to the sense electrode.

DYCAL™ (Dynamic Calibration) is a special form of hysteresis that can track slow varying environmental change even while the sensor is in a touch state. This is ideal for portable applications.

The *charge transfer* method of capacitive sensing is employed on the IQS228D. (The Charge Transfer principle is thoroughly described in the application note: [AZD004 - Azoteq Capacitive Sensing.](#))

1.2 Operation

The device has been designed to be used in applications where proximity is required, and touch conditions can prevail for an extended period of time which may result in uncompensated drift in conventional capacitive sensors.

A low threshold is used to detect the proximity of an object with a higher threshold for touch detection.

Dynamic Calibration is performed when a **TOUCH** condition is detected for longer than t_{DYCAL} . The hysteresis algorithm will now check for the release condition of the touch, while still tracking environmental changes.

1.3 Applicability

All specifications, except where specifically mentioned otherwise, provided by this datasheet are applicable to the following ranges:

- > Temperature:
 - IQS228D: -40°C to 85°C
- > Supply voltage (V_{DDHI}): 2.4 V to 5 V



2 Packaging and Pin-Out

2.1 IQS228D

The IQS228D is available in a DFN-6 package.

2.1.1 Pin-out

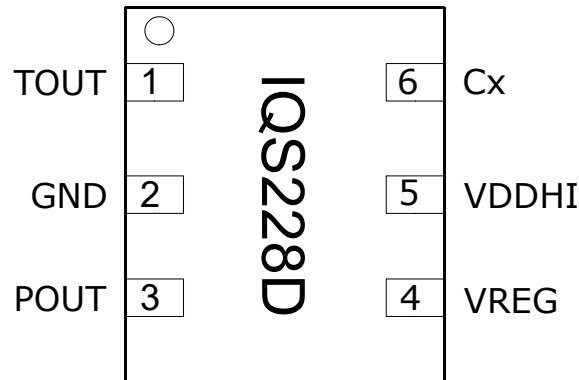

Figure 2.1: DFN-6 Pin-out

Table 2.1: DFN-6 Pin-out Description

| Pin | Name | Type | Function |
|-----|-------|----------------------|---|
| 1 | OUT | Digital Output | Output |
| 2 | GND | Ground | GND Reference |
| 3 | CTRL | Digital Input/Output | Control input or proximity output |
| 4 | VREG | Analogue Output | Internal Regulator Pin (Connect 1 μ F bypass capacitor) |
| 5 | VDDHI | Supply Input | Supply Voltage Input |
| 6 | Cx | Analogue I/O | Sense Electrode |



2.2 Schematic

2.2.1 DFN-6

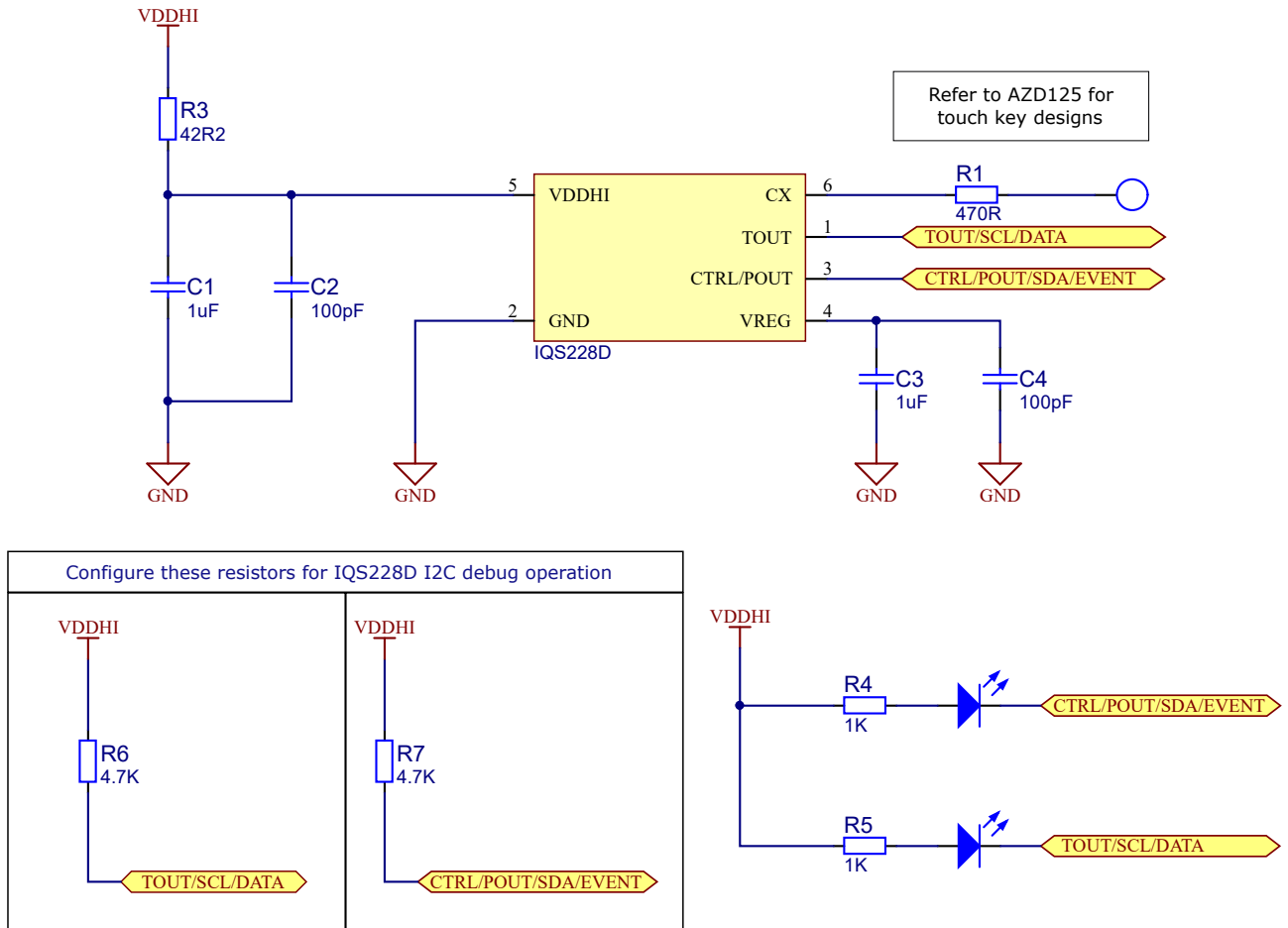

Figure 2.2: Typical application schematic of IQS228D. 100 pF capacitors are optional for added RF immunity. Place all decoupling capacitors (on VDDHI and VREG) as close to the IC as possible.

Pins TOUT and CTRL/POUT can be set as Active High or Active Lowⁱ. See Section 3.1 for more information.

Where a system level ESD strike is found to cause the IC to go into ESD induced latch-up, it is suggested that the supply current to the IQS228D IC is limited by means of a series resistor that could limit the maximum supply current to the IC to < 80 mA.

The 1 μF capacitors on VDDHI and VREG are for default power mode. Please see Table 2.3 to select the correct capacitors for low power modes.

The 470 Ω series resistor on the Cx pin is added for ESD protection.

ⁱWith the Active High setting, a pull-up resistor is not required. Adding a pull-up resistor in Active High mode negatively impacts the current usage.



2.3 Recommended Capacitor Values

The 1uF VREG capacitor value is chosen to ensure VREG remains above the maximum BOD specification stated in Table 11.2. The combination of the 1uF VREG capacitor and the 1uF VDDHI capacitor is chosen to prevent a potential ESD issue. Recommended values to prevent this is shown in Table 2.2.

Table 2.2: VDDHI and VREG capacitor size recommendation to prevent ESD issues with typical hardware combinations

| Low Power Scan | 8ms(default) - 32ms | 64ms | 128ms | 160ms |
|--------------------------|----------------------------------|--------------------------------------|--------------------------------------|--------------------------------------|
| Capacitor recommendation | C1 = 1 μ F C3 = 1 μ F | C1 = 4.7 μ F C3 = 2.2 μ F | C1 = 4.7 μ F C3 = 2.2 μ F | C1 = 4.7 μ F C3 = 2.2 μ F |

2.4 Exception to recommended capacitor values

In applications where the VDDHI source has high internal resistance or a high resistance path, it will be required to ensure $C3 > C1$ to prevent a VDDHI BOD after the IC sleep cycle (see Table 11.2).

Table 2.3: Capacitor Values for VDDHI and VREG under certain supply voltage condition

| Low Power Scan | 8ms(default) - 32ms | 64ms | 128ms | 160ms |
|--------------------------|----------------------------------|--------------------------------------|-------------------------------------|-------------------------------------|
| Capacitor recommendation | C1 = 1 μ F C3 = 1 μ F | C1 = 2.2 μ F C3 = 4.7 μ F | C1 = 4.7 μ F C3 = 10 μ F | C1 = 4.7 μ F C3 = 10 μ F |



3 User Configurable Options

This section lists the user configurable settings. The device is fully functional in its default state, but some applications may require alternative configuration settings. These settings are enabled by configuring One Time Programmable (OTP) user options.

Popular configurations are available ex-stock - please check with the local distributor for availability. Azoteq can supply pre-configured devices for large quantities.

3.1 Configuring of Devices

Azoteq offers a Configuration Tool (CT210) and accompanying software (USBProg2.exe) that can be used to program the OTP user options for prototyping purposes.

Alternative programming solutions for the IQS228D also exist. For further enquiries regarding this, please contact Azoteq at ProxSenseSupport@azoteq.com or the local distributor.

Tables 3.1 to 3.4 all represent a hexadecimal byte in the IC configuration segment of the ordering number. As example, Table 3.1 corresponds to the last two numeric digits. These digits are shown in bold text in the caption of the Table. The ordering numbers and information are explained in Section 12.1

Table 3.1: User Selectable Configuration Options: Bank 0 (0xC4H) – IQS228D00000000DNR

| Bit 7 | Bit 6 | Bit 5 | Bit 4 | Bit 3 | Bit 2 | Bit 1 | Bit 0 |
|-------|--------------------|-------|-------------------|-------------------|-------------------|-------------------|-------------------|
| IN_EN | REL _{THR} | LOGIC | T _{THR2} | T _{THR1} | T _{THR0} | P _{THR1} | P _{THR0} |

| | | |
|----------------|---|------------------------------|
| Bit 7 | IN_EN: Input Enable 0 = Output (Proximity) 1 = Input | Section 10.2 |
| Bit 6 | REL_{THR}: Release threshold 0 = 75 % 1 = 85 % | Section 10.1 |
| Bit 5 | LOGIC: Output logic select (Only when STREAMING mode is disabled) 0 = Active Low (Open drain configuration - pull-up resistor required) 1 = Active High (Push-pull configuration - no pull-up resistor required) | Section 7.2 |
| Bit 4-2 | T_{THR}: Touch Threshold Selections 000 = 72/256 001 = 4/256 010 = 8/256 011 = 24/256 100 = 48/256 101 = 96/256 110 = 128/256 111 = 160/256 | Section 7.5 |
| Bit 1-0 | P_{THR}: Proximity Threshold Selections 00 = 4 01 = 2 10 = 8 11 = 16 | Section 7.4 |



Table 3.2: User Selectable Configuration Options: Bank 1 Full ATI (0xC5H) – IQS228D0000000DNR

| Bit 7 | Bit 6 | Bit 5 | Bit 4 | Bit 3 | Bit 2 | Bit 1 | Bit 0 |
|--------------------|--------------------|-------|-------|-------|-------------------|-------------------|-------------------|
| t _{HALT1} | t _{HALT0} | ~ | ~ | TURBO | BASE ₂ | BASE ₁ | BASE ₀ |

- Bit 7-6** **t_{HALT}**: Halt times Section [7.11](#)
 00 = 20 seconds
 01 = 40 seconds
 10 = Never
 11 = seconds
- Bit 5-4** **Not used**
- Bit 3** **TURBO**: DYCAL TURBO Section [7.10](#)
 0 = Disabled
 1 = Enabled
- Bit 2-0** **BASE**: Base Value Section [9.3](#)
 000 = 200
 001 = 50
 010 = 75
 011 = 100
 100 = 150
 101 = 250
 110 = 300
 111 = 500



Table 3.3: User Selectable Configuration Options: Bank 2 (0xC6H) - IQS228D0000000DNR

| Bit 7 | Bit 6 | Bit 5 | Bit 4 | Bit 3 | Bit 2 | Bit 1 | Bit 0 |
|----------------|---|-------|-------|--------|-------|-----------------|------------------------------|
| STREAM | TRANS | COMMS | ~ | TARGET | ATI | LP ₁ | LP ₀ |
| Bit 7 | STREAM: Streaming Method | | | | | | Section 8.2 |
| | 0 = 1-wire | | | | | | |
| | 1 = 2-wire (I ² C) | | | | | | |
| Bit 6 | TRANS: Charge Transfer Frequency | | | | | | Section 7.7 |
| | 0 = 512 kHz | | | | | | |
| | 1 = 250 kHz | | | | | | |
| Bit 5 | COMMS: Streaming Enable | | | | | | Section 8 |
| | 0 = Disabled | | | | | | |
| | 1 = Enabled | | | | | | |
| Bit 4 | Reserved - Set 0 | | | | | | |
| Bit 3 | TARGET: ATI Target Counts | | | | | | Section 7.8 |
| | 0 = 1200 | | | | | | |
| | 1 = 1024 | | | | | | |
| Bit 2 | ATI: ATI Selection | | | | | | Section 7.9 |
| | 0 = Full | | | | | | |
| | 1 = Partial (Not Recommended) | | | | | | |
| Bit 1-0 | LP: Power Mode Selection | | | | | | Section 7.12 |
| | 00 = BP, 9ms (64ms if zoom is disabled) | | | | | | |
| | 01 = NP, 128ms | | | | | | |
| | 10 = LP1, 256ms | | | | | | |
| | 11 = LP2, 512ms | | | | | | |

Table 3.4: User Selectable Configuration Options: Bank 3 (0xC7H) - IQS228D0000000DNR

| Bit 7 | Bit 6 | Bit 5 | Bit 4 | Bit 3 | Bit 2 | Bit 1 | Bit 0 |
|----------------|----------------------------|-------|-------|-------|-------|-------|------------------------------|
| ~ | ~ | ~ | ~ | ZOOM | ~ | ~ | CTRL |
| Bit 7-4 | Reserved | | | | | | |
| Bit 3 | ZOOM: Zoom Disable | | | | | | Section 7.13 |
| | 0 = Zoom Enabled | | | | | | |
| | 1 = Zoom Disabled | | | | | | |
| Bit 2-1 | Reserved | | | | | | |
| Bit 0 | CTRL: Control Input | | | | | | Section 7.1 |
| | 0 = Halt Charge | | | | | | |
| | 1 = Filter Halt | | | | | | |



4 Measuring Capacitance Using the *Charge Transfer* Method

The *charge transfer* method of capacitive sensing is employed on the IQS228D.

A charge cycle is used to take a measurement of the capacitance of the sense electrode (connected to Cx) relative to ground. It consists of a series of pulses charging Cx and discharging Cx to the reference capacitor, at the charge transfer frequency (f_{Cx} - refer to Section 11.2). The number of pulses required to reach a trip voltage on the reference capacitor is referred to as the **Count** value (CS) which is the instantaneous capacitive measurement. The Counts (CS) are used to determine if either a physical contact or proximity event occurred, based on the change in CS detected. The typical values of CS, without a touch or proximity condition range between 1344 and 1865 counts, although higher and lower counts can be used based on the application requirements. With CS larger than +/-1865 the gain of the system may become too high causing unsteady operation.

The IQS228D schedules a charge cycle every t_{SAMPLE} seconds to ensure regular samples for processing of results. The duration of the charge cycle is defined as t_{CHARGE} and varies according to the counts required to reach the trip voltage. Following the charge cycle other activities such as data streaming is completed (if in streaming mode), before the next charge cycle is initiated.

Please note: Attaching a probe to the Cx pin will increase the capacitance of the sense plate and therefore C_s . This may have an immediate influence on the Counts value (decrease t_{CHARGE}) and cause a proximity or touch event. After t_{HALT} seconds the system will adjust to accommodate for this charge. If the total load on Cx, with the probe attached is still lower than the maximum Cx load the system will continue to function normally after t_{HALT} seconds with the probe attached.

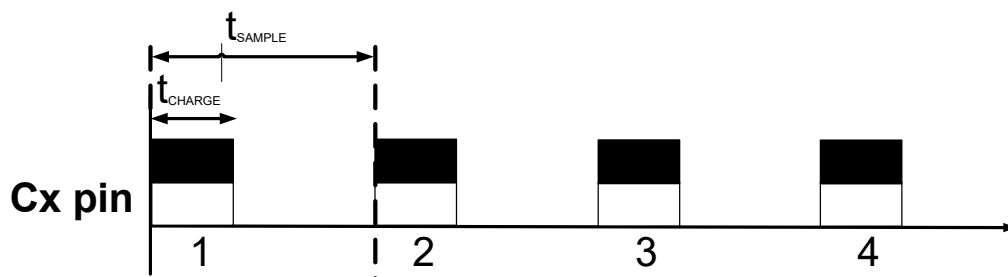

Figure 4.1: Charge cycles as can be seen on Cx.



5 DYCAL™ Operation

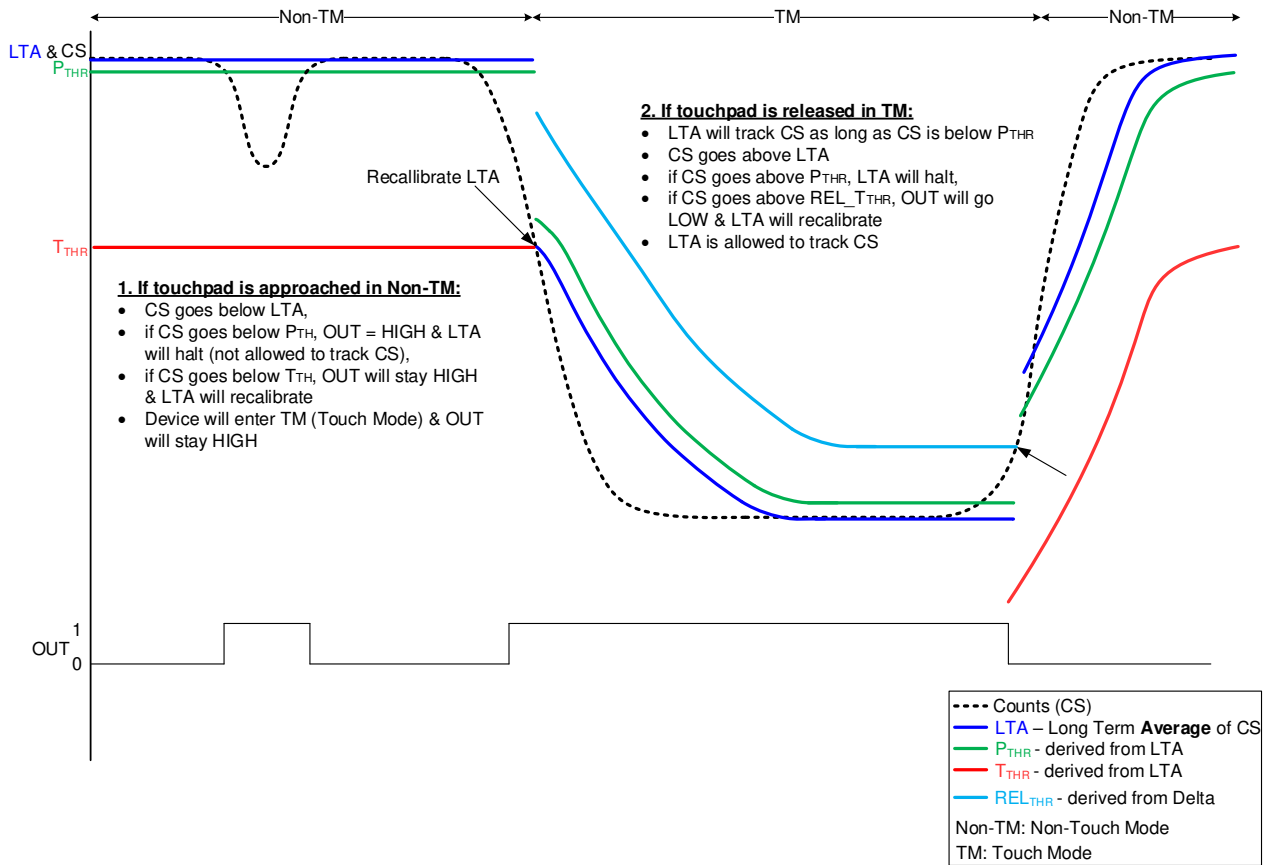

Figure 5.1: DYCAL Operation (Self Capacitive Sensing)



6 Operating Principle

Figure 5.1 is a visual representation of the DYCAL functionality. The OUT pin is used to indicate the status of a DYCAL event (both proximity and touch event). The DYCAL functionality is summarised below.

Non-Touch Mode

The OUT pin is activated on the successful detection of a proximity event and will remain activated for the duration of the proximity event, permitting that this event is no longer than the filter halt timings. The LTA will be halted in this time.

As soon as a touch condition is detected (Count values, or CS, fall below T_{THR}), the controller will dynamically re-calibrate its LTA to the halted LTA - T_{THR} . The IC is now Touch Mode.

Touch Mode

After re-calibration of the LTA, it will follow the Counts (CS) and be allowed to track slow varying environmental changes. If the Counts (CS) were to exceed the LTA by the release threshold (REL_T_{THR}) the touch detection will stop, and the OUT pin will return to its original state.

7 Configurable Settings

This section describes the user configurable options of the IQS228D in more detail.

User programmable options are selected by configuring the OTP selections. Please refer to Section 3 for an overview of the configurable settings.

7.1 CTRL: External Control

The user has the option to control some parameters of the IQS228D from an external source. The IC can be used in default mode (CTRL unconnected) or the user can use the CTRL pin to select whether the master should halt the charge transfers (i.e. stop operation) or to halt LTA filter tracking on the IQS228D.

7.1.1 Charge Halt

If CTRL is sampled high for longer than T_{EXT_HALT} , the charge conversion cycle will be halted, once the current conversion has been completed. The device will remain in this standby mode until the CTRL line is sampled low again. An automatic reseed is performed directly after CTRL is released to compensate for any environmental changes which might have occurred during standby mode.

7.1.2 Halt LTA Filter

When configured in this mode, CTRL can be used to control the LTA halt times when sampled high. The CTRL pin has precedence over the configurations bits selected for the halt timings.

If CTRL is sampled high for longer than T_{EXT_HALT} , the filter will be halted until this pin is sampled low.

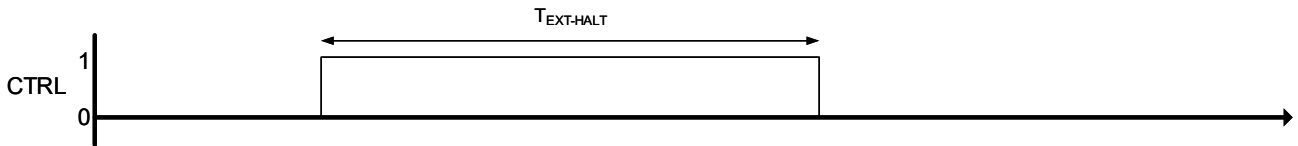

Figure 7.1: Master Output signal on CTRL pin to Halt Operation or Filter Halt

7.1.3 Pulse on CTRL:

The pulse on the CTRL pin needs to adhere to the following timing constraints:
 $25\text{ ms} < T_{PULSE} < 35\text{ ms}$

7.1.3.1 IQS228D: Reseed A reseed condition can be initiated by generating a pulse on the CTRL pin. The LTA will be reset to the count, forcing the OUT pin to its original state.

If the count value is outside its allowable limits, the device will force an ATI event to reset the system sensitivity. (Please refer to Section 8.1 for more details).

7.1.3.2 IQS228D: re-ATI A re-ATI condition can be initiated by generating a pulse on the CTRL pin. This function can be issued at any time.



Figure 7.2: Master Output signal on CTRL to force a Reseed Condition.

7.2 LOGIC

The logic used by the device can be selected as active HIGH or active LOW. The output pins OUT and CTRL will function based on this selection. When configured as Active High, the outputs will remain high after POR until ATI has completed. The ATI time will vary according to the capacitive load on the sensor, but typically does not exceed 500 ms.

Configuration: Bank 0 Bit 5

| LOGIC : Logic Output Selection | |
|--------------------------------|--|
| Bit | Selection |
| 0 | Active Low (Open drain configuration - pull-up resistor required) |
| 1 | Active High (Push-pull configuration - no pull-up resistor required) |

A software open drain output is implemented for the OUT pin when configured in active low mode. The voltage on the pull-up resistor is limited to the IQS228D supply voltage. A 4k7-10kΩ resistor between OUT and VDDHI is recommended.

7.3 RF Noise on IQS228D

7.3.1 IQS228D RF Noise Immunity

Design guidelines should be followed to ensure the best noise immunity. The design of capacitive sensing applications can encompass a large range of situations but as a summary the following should



be noted to improve a design:

- > A ground plane should be placed under the IC, except under the Cx line.
- > All the tracks on the PCB must be kept as short as possible.
- > The capacitor between VDDHI and GND as well as between VREG and GND, must be placed as close as possible to the IC.
- > A 100 pF capacitor should be placed in parallel with the 1 μF capacitor between VDDHI and VSS. Another 100 pF capacitor can be placed in parallel with the 1 μF capacitor between VREG and GND.
- > If the device is too sensitive for a specific order option, a parasitic capacitor (typically 20 pF) can be added between Cx line and ground.
- > Proper sense electrode and button design principles must be followed. See application note [AZD125 - Capacitive Sensing Design Guide](#) for more information.
- > Unintentional coupling of the sense electrode to ground and other circuitry must be limited by increasing the distance to these sources.

In some instances a ground plane some distance from the device and sense electrode may provide significant shielding from undesired interference.

When the capacitance between the sense electrode and ground becomes too large the sensitivity of the device may be influenced.

7.4 Proximity Threshold

The IQS228D has 4 proximity threshold settings indicated in counts. The proximity threshold is selected by the designer to obtain the desired sensitivity and noise immunity. A proximity event is triggered if the Counts (CS) diverges more than the selected threshold from the LTA for 6 consecutive cycles.

Configuration: [Bank 0 Bit 1-0](#)

| P _{THR1} :P _{THR0} : Proximity Thresholds | |
|---|----------------------|
| Bit | Selection |
| 00 | 4 |
| 01 | 2 (Most sensitive) |
| 10 | 8 |
| 11 | 16 (Least sensitive) |

7.5 Touch Threshold

The IQS228D has 8 touch threshold settings indicated in counts. The touch threshold is selected by the designer to obtain the desired touch sensitivity. A touch event is triggered if the Counts (CS) diverges more than the selected threshold from the LTA for 2 consecutive cycles.

In the NO-TOUCH STATE the Counts (CS) must diverge more than the touch threshold value below the LTA. Operating in the TOUCH STATE, the CS must diverge more than REL_T_{THR} of the touch threshold value above the LTA.

The following equation is used to determine if a touch or release event occurred.

NO-TOUCH STATE: $LTA - CS \leq T_{THR}$
 TOUCH STATE: $CS - LTA \geq REL_T_{THR}$



Configuration: [Bank 0 Bit 4-2](#)

| T _{THR2} :T _{THR0} : Touch Thresholds | | |
|---|-----------|-------------------|
| Bit | Selection | |
| 000 | 72/256 | |
| 001 | 4/256 | (Most sensitive) |
| 010 | 8/256 | |
| 011 | 24/256 | |
| 100 | 48/256 | |
| 101 | 96/256 | |
| 110 | 128/256 | |
| 111 | 160/256 | (Least sensitive) |

7.6 Multipliers

When using partial ATI, the base value is set up using the multipliers. Compensation will still be added automatically to reach the target.

7.7 Charge Transfer

The charge transfer frequency of the IQS228D is adjustable. Changing the transfer frequency will affect sensitivity and response rate. Two options are available:

Configuration: [Bank 2 Bit 6](#)

| TRANS : Charge Transfer Frequency | | |
|-----------------------------------|-----------|--|
| Bit | Selection | |
| 0 | 512 kHz | |
| 1 | 250 kHz | |

7.8 Target Counts

The target of the ATI algorithm can be adjusted between 1200 (default) and 1024 counts. When less sensitivity is required, the lower counts will also increase response rate:

Configuration: [Bank 2 Bit 3](#)

| Target : ATI target counts | | |
|----------------------------|-----------|--|
| Bit | Selection | |
| 0 | 1200 | |
| 1 | 1024 | |

7.9 Enable Partial ATI

In some applications the startup time of the IQS228D may be required to be decreased. This is possible by enabling partial ATI, if the multipliers required can be determined, and the compensation alone is adequate to account for environmental change.



Configuration: [Bank 2 Bit 2](#)

| ATI : Partial ATI | |
|-------------------|-----------|
| Bit | Selection |
| 0 | Disbaled |
| 1 | Enabled |

7.10 DYCAL TURBO

In some applications, it may be required to improve the entry and exit speed of Touch Mode by removing the entry reseed delay, as well as turning off the AC-filters. This can be done by enabling the DYCAL TURBO mode.

Configuration: [Bank 1 Bit 3](#)

| TURBO : DYCAL TURBO | |
|---------------------|-----------|
| Bit | Selection |
| 0 | Disabled |
| 1 | Enabled |

Note that if DYCAL TURBO is enabled, the LTA will halt at the reseed point for t_{HALT} if Touch Mode is entered before a proximity event is registered.

7.11 Filter Halt

The LTA filter only executes while no proximity events are detected to ensure compensation only for environmental changes. Once touch event is detected the filter will resume operation and will no longer be halted. The halt timing configuration settings determine how long the filter is halted.

Configuration: [Bank 1 Bit 7-6](#)

| Filter Halt : Filter Halt | |
|---------------------------|------------|
| Bit | Selection |
| 00 | 20 seconds |
| 01 | 40 seconds |
| 10 | Never |
| 11 | 3 seconds |

The presence of a proximity condition for a time exceeding the halt time will be deemed as a fault state which would trigger a reseed event where after the output state an OUT pin will be reset to its original condition.

7.12 Low Power Modes

There are 4 low power(LP) modes. The LP modes will decrease the sampling rate which will reduce the *power consumption* of the device. However, this will also decrease the response time of the device.



Configuration: *Bank 2 Bit 1-0*

| LP : Power Mode Selection | |
|---------------------------|------------------------------------|
| Bit | Selection |
| 00 | 9.1 ms (BP) 64 ms if Zoom disabled |
| 01 | 128 ms (Normal Power Mode) |
| 10 | 256 ms (Low Power Mode 1) |
| 11 | 512 ms (Low Power Mode 2) |

7.13 Zoom

The IQS228D has the option to disable the zoom function. This means that the sample time will stay fixed, even when proximity and touch events are made. When this is activated, boost power mode will change from a 9 ms sample time, to 64ms.

Configuration: *Bank 3 Bit 3*

| ZOOM: Zoom Disable | |
|--------------------|-----------|
| Bit | Selection |
| 0 | Enabled |
| 1 | Disabled |



8 Streaming Mode

The IQS228D has the capability to stream data to the MCU. This provides the designer the ability to obtain the parameters and sensor data within the device in order to aid design into applications. Data streaming is performed as a 1-wire data protocol on the OUT pin OR I²C interface. The output function of this pin is therefore lost when the device is configured in streaming mode. Data Streaming can be enabled as indicated below:

Configuration: *Bank 2 Bit 5*

COMMS : Stream Mode Enable

- | | |
|---|----------|
| 0 | Disabled |
| 1 | Enabled |

Figure 8.1 illustrates the communication protocol for initialising and sending data with the 1-wire communication protocol.

1. Communications initiated by a START bit. Bit defined as a low condition for T_{START} .
2. Following the START bit, is a synchronisation byte ($T_{INIT} = 0xAA$). This byte is used by the MCU for clock synchronisation.
3. Following T_{INIT} the data bytes will be sent. 8 Bytes will be sent after each charge cycle.
4. Each byte sent will be preceded by a START bit and a STOP bit will follow every byte.
5. STOP bit indicated by taking pin 1 high. The STOP bit does not have a defined period.

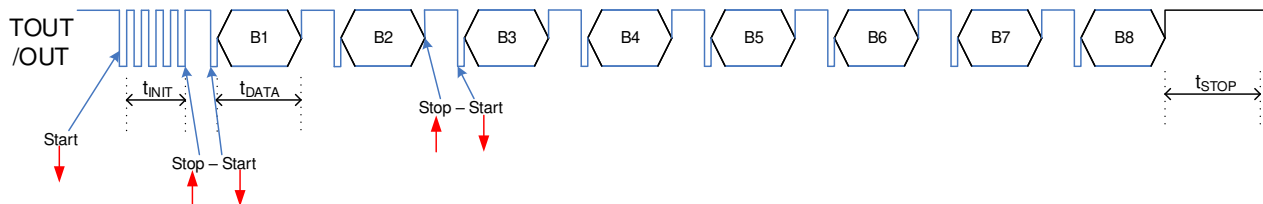

Figure 8.1: Debug: 1-wire streaming Debug Mode



The following table defines the bit definitions for the IQS228D devices during Streaming Mode.

Table 8.1: Byte Definitions for Streaming Mode

| Byte (B) | Bit | Value |
|---------------|-------------|---------------|
| 0 | ~ | AA |
| 1 | 7:0 | CS High Byte |
| 2 | 15:8 | CS Low Byte |
| 3 | 23:16 | LTA High Byte |
| 4 | 31:24 | LTA Low Byte |
| 5 (Sys Flags) | 39 | ~ |
| | 38 | ~ |
| | 37 | Active High |
| | 36 | Filter Halt |
| | 35 | LP Active |
| | 34 | ATI Busy |
| | 33 | Noise Found |
| 6 | 32 | In Zoom |
| | 47 | Touch |
| | 46 | Proximity |
| | 45 | Multipliers |
| | 44 | Multipliers |
| | 43 | Multipliers |
| | 42 | Multipliers |
| | 41 | Multipliers |
| 40 | Multipliers | |
| 7 | 55:48 | Compensation |
| 8 | 63:56 | Counter |

8.1 Event Mode

The IQS228D has Event Mode implemented during 1-wire communication. This allows the MCU to monitor the POUT pin for status changes (proximity or touch made or released events) instead of capturing data continuously. Upon status change, the IQS228D will pull the POUT pin for low to indicate to the MCU to read data. The POUT pin will stay low for 1.6ms.



8.2 I²C

The IQS228D also allows for I²C streaming debugging. Data Streaming can be changed from 1-wire protocol to I²C as shown below:

Configuration: [Bank 2 Bit 7](#)

| STREAM : Streaming Mode | |
|-------------------------|----------------------------|
| 0 | 1-Wire Protocol |
| 1 | I ² C Streaming |

The Memory Map for the IQS228D can be found in [Appendix A](#).

The IQS228D can communicate on an I²C compatible bus structure. Note that 4.7 k Ω pull-up resistors should be placed on SDA and SCL.

The Control byte indicates the 7-bit device address (0x44H) and the Read/Write indicator bit.



9 Automatic Tuning Implementation (ATI)

ATI is a sophisticated technology implemented in ProxSense® devices that optimises the performance of the sensor in a wide range of applications and environmental conditions (refer to application note [AZD004 - Azoteq Capacitive Sensing](#)).

ATI makes adjustments through external reference capacitors unnecessary (as required by most other solutions) to obtain optimum performance.

9.1 Full ATI

The IQS228D implements an automatic ATI algorithm. This algorithm automatically adjusts the ATI parameters to optimise the sensing electrodes connection to the device.

The device will execute the ATI algorithm whenever the device starts-up and or when the counts are not within a predetermined range.

There are 2 important definitions to understand for ATI:

9.2 ATI Target

ATI adjusts internal circuitry according to two parameters, the **ATI multiplier** and the **ATI compensation**.

- > The **ATI multiplier** can be viewed as a course adjustment of the Counts (CS), used to achieve the ATI BASE value.
- > The **ATI compensation** is a fine adjustment used to reach the ATI TARGET value.

With these two parameters the Counts (CS) of the IQS228D is tuned until as ATI target value of 1200 is achieved.

9.3 ATI_{BASE} : Significance of ATI Base

As mentioned above, the **ATI multiplier** is used to select a base value for the ATI. The ATI BASE value is important, as this determines the sensitivity of the device. The sensitivity can be defined as:

Sensitivity = $ATI_{TARGET} / ATI_{BASE}$

The ATI Target remains fixed at 1200 and it can thus be seen from this that a large base value will result in a less sensitive device. The designer has the option to increase/reduce the sensitivity of the system through the ATI BASE value. For most applications the ATI BASE should be kept default.



The options for the ATI BASE values are as follows:

Configuration: *Bank 1 Bit 2-0*

| BASE : ATI Base Selection | |
|---------------------------|-----------|
| Bit | Selection |
| 000 | 200 |
| 001 | 50 |
| 010 | 75 |
| 011 | 100 |
| 100 | 150 |
| 101 | 250 |
| 110 | 300 |
| 111 | 500 |

9.4 Sensitivity Due to ATI

The adjustment of the ATI parameters will result in variations in the count and sensitivity. Sensitivity can be observed as the change in count as the result of a fixed change in sensed capacitance. The ATI parameters have been chosen to provide significant overlap. It may therefore be possible to select various combinations of ATI multiplier and ATI compensation settings to obtain the same count. The sensitivity of the various options may however be different for the same count.

9.5 ATI Procedure

While the Automatic ATI algorithm is in progress, this condition will be indicated in the streaming data and proximity and touch events cannot be detected. The device will only briefly remain in this condition and it will be entered only when relatively large shifts in the count has been detected.

The automatic ATI function aims to maintain a constant count, regardless of the capacitance of the sense electrode (within the maximum range of the device).

The effects of the auto-ATI on the application are the following:

- > Automatic adjustment of the device configuration and processing parameters for a wide range of PCB and application design to maintain an optimal configuration for proximity and touch detection.
- > Automatic tuning of the sense electrode at start-up to optimise the sensitivity of the application.
- > Automatic re-tuning when the device detects changes in the sensing electrodes capacitance to accommodate a large range of changes in the environment of the application that influences the sensing electrode.
- > Re-tuning only occurs during device operation when a relatively large sensitivity reduction is detected. This is to ensure smooth operation of the device.
- > Re-tuning may temporarily influence the normal functioning of the device, but in most instances the effect will be hardly noticeable.
- > Shortly after the completion of the re-tuning process the sensitivity of a Proximity detection may be reduced slightly for a few seconds as internal filters stabilise.

Automatic ATI can be implemented so effectively due to:

- > Excellent system signal to noise ratio (SNR)
- > Effective digital signal processing to remove AC and other noise.



- > The very stable core of the devices.
- > The built-in capability to accommodate a large range of sensing electrode capacitances.



10 DYCAL Specific Settings

10.1 Release Threshold

The IQS228D has the option to increase the release threshold when in TM. This helps that small variations caused by moving a finger/hand on a touch pad will not cause the IC to exit TM, making the solution more robust. The options available are shown below:

Configuration: *Bank 0 Bit 6*

| REL _{THR} : Release Threshold Selection | |
|--|-----------------------|
| Bit | Selection |
| 0 | 75 % of Entry Delta |
| 1 | 87.5 % of Entry Delta |

After entering TM, as soon as the LTA follows to within 16 counts, an Entry Delta value is calculated as: > $\text{Entry Delta} = \text{LTA}_{\text{entry}} - \text{LTA}_{\text{current}}$

This calculated Entry Delta a value is used for the Release Threshold as shown below.

If upon entry, the LTA value is already within 16 Counts, the Entry Delta is taken as the calculated touch threshold value.

10.2 Input Enable

The IQS228D can be configured to have the CTRL pin function as an output on a Proximity event.

Choosing the CTRL pin as output removes the Filter Halt and Halt Charge options of the pin as an input.

Using a touch event to activate OUT will make the system less sensitive which is needed in some applications. The LTA will still halt with the detection of a proximity but will not have an influence on the OUT pin. The LTA will still re-calibrate once a touch condition is detected.

Configuration: *Bank 0 Bit 7*

| IN_EN : Input Enable Selection | |
|--------------------------------|-----------|
| Bit | Selection |
| 0 | Output |
| 1 | Input |



11 Electrical Specifications

11.1 Absolute Maximum Specifications

Exceeding these maximum specifications may cause damage to the device

| | |
|--|-------------------|
| Operating temperature: | -40°C to 85°C |
| Supply Voltage ($V_{DDHI}-V_{SS}$) | 5.5V |
| Maximum pin Voltage (T_{OUT} , CTRL) | $V_{DDHI} + 0.3V$ |
| Minimum pin voltage (V_{DDHI} , V_{REG} , T_{OUT} , CTRL, Cx) | $V_{SS} - 0.3V$ |
| Minimum power-on slope | 100V/s |
| ESD protection (V_{DDHI} , V_{REG} , V_{SS} , T_{OUT} , CTRL, Cx) | 8kV |

11.2 General Characteristics

IQS228D devices are rated for supply voltages between 2.4V and 5.0V.

Table 11.1: IQS228D General Operating Conditions

| Description | Conditions | Parameter | Min | Typ | Max | Unit |
|---------------------------------|------------------------------|--------------------|------|----------|------|---------|
| Supply voltage | | V_{DDHI} | 2.4 | ~ | 5 | V |
| Internal regulator output | $2.4 \leq V_{DDHI} \leq 5.0$ | V_{REG} | 1.98 | ~ | 2.08 | V |
| Boost operating current | $2.4 \leq V_{DDHI} \leq 5.0$ | $I_{IQS228D_BP}$ | ~ | 101 | ~ | μA |
| Normal operating current | $2.4 \leq V_{DDHI} \leq 5.0$ | $I_{IQS228D_NP}$ | ~ | 6 | ~ | μA |
| Low Power 1 operating current | $2.4 \leq V_{DDHI} \leq 5.0$ | $I_{IQS228D_LP1}$ | ~ | 4.5 | ~ | μA |
| Low Power 2 operating current | $2.4 \leq V_{DDHI} \leq 5.0$ | $I_{IQS228D_LP2}$ | ~ | <3.2 | ~ | μA |
| Charge transfer frequency range | $2.4 \leq V_{DDHI} \leq 5.0$ | $f_{Cx} = 512/250$ | -8% | f_{Cx} | +8% | kHz |

Charge Transfer Timings for low power modes are found in section [7.12](#).

Table 11.2: Start-up and shut-down slope Characteristics

| Description | Parameter | Min | Max | Unit |
|--|-------------------------------------|-----|-----|------|
| Reset release voltage on V_{DDHI} rising edge | V_{DDHI} Reset Rising Edge (POR) | ~ | 2.1 | V |
| Reset trigger voltage on V_{DDHI} falling edge | V_{DDHI} Reset Falling Edge (BOD) | 0.3 | ~ | V |
| Reset release voltage on V_{REG} rising edge | V_{REG} Reset Rising Edge (POR) | ~ | 1.8 | V |
| Reset trigger voltage on V_{REG} falling edge | V_{REG} Reset Falling Edge (BOD) | 0.3 | ~ | V |

11.3 Output Characteristics

Table 11.3: Digital I/O Characteristics

| Parameter | Test Conditions | Min | Typ | Max | Unit |
|-----------|---|---------------------|-----|---------------------|------|
| V_{OL} | T_{OUT} and P_{OUT} Output low voltage $I_{sink} = 10\text{ mA}$ | ~ | ~ | 0.3 | V |
| V_{OH} | Output high voltage $I_{source} = 5\text{ mA}$ | $V_{DD} - 0.3$ | ~ | ~ | V |
| V_{IL} | Input low voltage | ~ | ~ | $0.3 \times V_{DD}$ | V |
| V_{IH} | Input high voltage | $0.7 \times V_{DD}$ | ~ | ~ | V |

11.4 Packaging Information

11.4.1 DFN-6

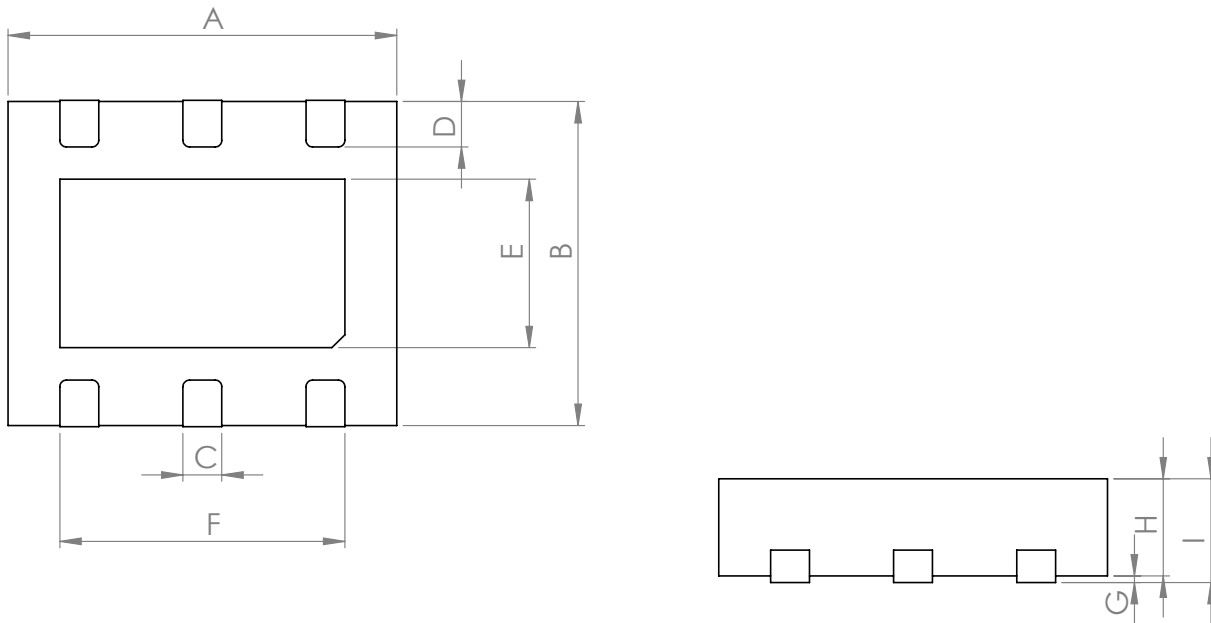

Figure 11.1: DFN-6 Packaging

Table 11.4: DFN-6 Dimensions

| Dimension | Min (mm) | Max (mm) |
|-----------|----------|----------|
| A | 3.00 | 3.00 |
| B | 2.50 | 2.50 |
| C | 0.30 | 0.30 |
| D | 0.35 | 0.35 |
| E | 1.30 | 1.30 |
| F | 2.20 | 2.20 |
| G | 0.05 | 0.05 |
| H | 0.75 | 0.75 |
| I | 0.80 | 0.80 |

11.4.2 MSL Level

Moisture Sensitivity Level (MSL) relates to the packaging and handling precautions for some semiconductors. The MSL is an electronic standard for the time period in which a moisture sensitive device can be exposed to ambient room conditions (approximately 30°C/85% RH see J-STD003C for more information) before reflow occurs.

| Package | Level (duration) |
|---------|--|
| DFN-6 | MSL 1 (Unlimited at $\leq 30^{\circ}\text{C}/85\% \text{RH}$) Reflow profile peak temperature $< 260^{\circ}\text{C}$ for < 30 seconds |



12 Datasheet and Part-number Information

12.1 Ordering Information

Contact the official distributor for sample quantities. A list of the distributors can be found under the "Distributors" section of www.azoteq.com. Special MOQs apply for custom configurations

The Part-number can be generated by using USBProg2.exe.

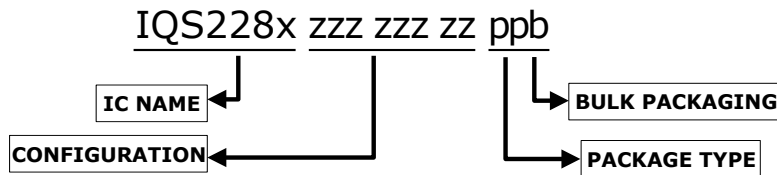

| | | | |
|-----------------------|------------|---|---|
| IC NAME | IQS228D | = | Self Capacitive IC with Dual Outputs |
| CONFIGURATION | zzz zzz zz | = | IC Configuration (hexadecimal - See Section 3.1) |
| PACKAGE TYPE | DN | = | DFN-6 package |
| BULK Packaging | R | = | Reel (6000pcs/reel) – MOQ = 6000pcs MOQ = 1 reel. (Orders shipped as full reels) |

12.2 Device Marking - Top

12.2.1 DFN-6 Package Markings

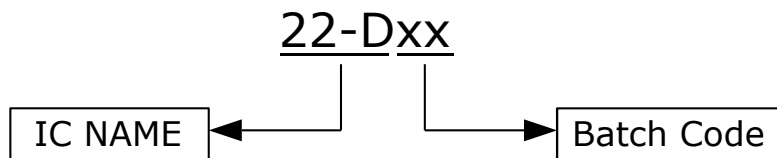

Figure 12.1: Top Marking of IQS228D

| | | | |
|-------------------|------|---|-------------------------|
| IC NAME | 22-D | = | IQS228D Self Capacitive |
| Batch Code | xx | = | AA to ZZ |



12.2.2 Tape and Reel Specification

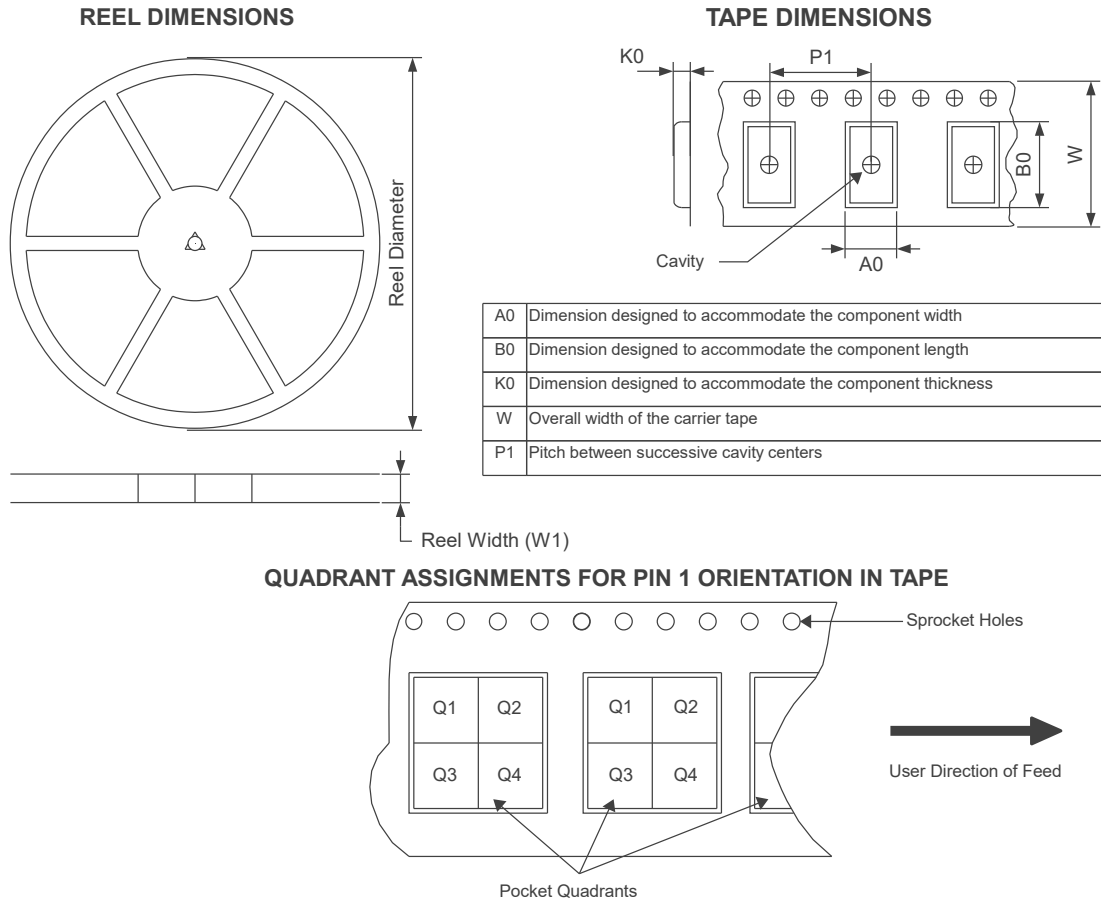

Figure 12.2: DFN-6 Tape Specification

Table 12.1: Tape and Reel Dimensions

| Device | Package Type | Package Drawing | Pins | QTY per reel | Reel Diameter (mm) | Reel Width W1 (mm) | A0 (mm) | B0 (mm) | K0 (mm) | P1 (mm) | W (mm) | Pin1 Quadrant |
|--------------------|--------------|-----------------|------|--------------|--------------------|--------------------|---------|---------|---------|---------|--------|---------------|
| IQS228DzzzzzzzzDNR | DFN6 | DFN-6 | 6 | 6000 | 330 | 12 | 2.8 | 3.3 | 1.2 | 4 | 12 | Q1 |



A Memory Map

Device Information

| | | | | | | | | | | |
|-----|--------------------------|-------|---|---|---|---|---|---|---|--------------|
| 00H | Product Number (PROD_NR) | | | | | | | | | |
| | Bit | 7 | 6 | 5 | 4 | 3 | 2 | 1 | 0 | |
| | Access | Value | | | | | | | | 39 (Decimal) |
| | R | Note | | | | | | | | |

| | | | | | | | | | | |
|-----|-------------------------|-------|---|---|---|---|---|---|---|--------------|
| 01H | Software Number (SW_NR) | | | | | | | | | |
| | Bit | 7 | 6 | 5 | 4 | 3 | 2 | 1 | 0 | |
| | Access | Value | | | | | | | | 29 (Decimal) |
| | R | Note | | | | | | | | |

[00H] PROD_NR

The product number for the IQS228D is 39 (Decimal).

[01H] SW_NR

The software version number of the device ROM can be read in this byte. The latest software version is 29 (Decimal).

| | | | | | | | | | |
|-----|--------------------------|------|---|-------|------|----|-----|---|------|
| 10H | System Flags (Sys_Flags) | | | | | | | | |
| | Bit | 7 | 6 | 5 | 4 | 3 | 2 | 1 | 0 |
| | Access | ~ | ~ | Logic | Halt | LP | ATI | ~ | Zoom |
| | R | Note | | | | | | | |

[10H] SYSFLAGS0

- Bit 7-6:** **Reserved**
- Bit 5:** **Logic:** Logic Output Indication.
0 = Active Low
1 = Active High
- Bit 4:** **Halt:** Indicates Filter Halt Status.
0 = LTA not being Halted
1 = LTA Halted
- Bit 3:** **LP:** Low Power Mode.
0 = Sample time BP



- 1 = Sample time LP
- Bit 2:** **ATI:** Status of automated ATI routine.
0 = ATI is not busy
1 = ATI in progress
- Bit 1:** **Reserved**
- Bit 0:** **Zoom:** Zoom will indicate full-speed charging once an undebounced proximity is detected. In BP mode, this will not change the charging frequency.
0 = IC not zoomed in
1 = IC detected undebounced proximity and IC is charging at full speed (BP)

| | | | | | | | | | |
|------------|---------------|-------|---|---|---|---|---|-------|------|
| 31H | Status | | | | | | | | |
| | Bit | 7 | 6 | 5 | 4 | 3 | 2 | 1 | 0 |
| | Value | DYCAL | ~ | ~ | ~ | ~ | ~ | Touch | Prox |
| Access | | | | | | | | | |
| R | Note | | | | | | | | |

[31H] Status

- Bit 7:** **DYCAL:** DYCAL Detection.
0 = Not Active
1 = Active
- Bit 6-2:** **Reserved**
- Bit 1:** **Touch:** Touch Detection.
0 = Not Active
1 = Active
- Bit 0:** **Prox:** Proximity Detection.
0 = Not Active
1 = Active

| | | | | | | | | | |
|------------|---------------------------|------------------|---|---|---|---|---|---|---|
| 42H | Counts_High (CS_H) | | | | | | | | |
| | Bit | 7 | 6 | 5 | 4 | 3 | 2 | 1 | 0 |
| | Value | Counts High Byte | | | | | | | |
| Access | | | | | | | | | |
| R | Note | | | | | | | | |



43H

Counts_Low (CS_L)

| | | | | | | | | |
|----------|-----------------|---|---|---|---|---|---|---|
| Bit | 7 | 6 | 5 | 4 | 3 | 2 | 1 | 0 |
| Access | Value | | | | | | | |
| R | Counts Low Byte | | | | | | | |
| | Note | | | | | | | |

83H

LTA_High (LTA_H)

| | | | | | | | | |
|----------|-----------------------------|---|---|---|---|---|---|---|
| Bit | 7 | 6 | 5 | 4 | 3 | 2 | 1 | 0 |
| Access | Value | | | | | | | |
| R | Long Term Average High Byte | | | | | | | |
| | Note | | | | | | | |

84H

LTA_Low (LTA_L)

| | | | | | | | | |
|----------|----------------------------|---|---|---|---|---|---|---|
| Bit | 7 | 6 | 5 | 4 | 3 | 2 | 1 | 0 |
| Access | Value | | | | | | | |
| R | Long Term Average Low Byte | | | | | | | |
| | Note | | | | | | | |

C4H

Fuse Bank 0 (FB_0)

| | | | | | | | | |
|----------|--------------------------------|---|---|---|---|---|---|---|
| Bit | 7 | 6 | 5 | 4 | 3 | 2 | 1 | 0 |
| Access | Value | | | | | | | |
| R | See Table 3.1 for more details | | | | | | | |
| | Note | | | | | | | |

C5H

Fuse Bank 1 (FB_1)

| | | | | | | | | |
|----------|--------------------------------|---|---|---|---|---|---|---|
| Bit | 7 | 6 | 5 | 4 | 3 | 2 | 1 | 0 |
| Access | Value | | | | | | | |
| R | See Table 3.2 for more details | | | | | | | |
| | Note | | | | | | | |

C6H

Fuse Bank 2 (FB_2)

| | | | | | | | | |
|----------|--------------------------------|---|---|---|---|---|---|---|
| Bit | 7 | 6 | 5 | 4 | 3 | 2 | 1 | 0 |
| Access | Value | | | | | | | |
| R | See Table 3.3 for more details | | | | | | | |
| | Note | | | | | | | |

C7H

Fuse Bank 3 (FB_3)

| | | | | | | | | |
|----------|--------------------------------|---|---|---|---|---|---|---|
| Bit | 7 | 6 | 5 | 4 | 3 | 2 | 1 | 0 |
| Access | Value | | | | | | | |
| R | See Table 3.4 for more details | | | | | | | |
| | Note | | | | | | | |



C8H

DEFAULT_COMMS_POINTER

| Bit | 7 | 6 | 5 | 4 | 3 | 2 | 1 | 0 |
|--------|---|---|---|---|---|---|---|---|
| Access | Value (Beginning of Device Specific Data) | | | | | | | |
| R/W | Default 10H | | | | | | | |

[C8H] Default Comms Pointer

The value stored in this register will be loaded into the Comms Pointer at the start of a communication window. For example, if the design only requires the Proximity Status information each cycle, then the Default Comms Pointer can be set to **ADDRESS 31H**. This would mean that at the start of each communication window, the comms pointer would already be set to the Proximity Status register, simply allowing a **READ** to retrieve the data, without the need of setting up the address.



Contact Information

| | USA | Asia | South Africa |
|-------------------------|--|--|---|
| Physical Address | 11940 Jollyville Suite 120-S Austin TX 78759 USA | Room 501A, Block A T-Share International Centre Taoyuan Road, Nanshan District Shenzhen, Guangdong, PRC | 1 Bergsig Avenue Paarl 7646 South Africa |
| Postal Address | 11940 Jollyville Suite 120-S Austin TX 78759 USA | Room 501A, Block A T-Share International Centre Taoyuan Road, Nanshan District Shenzhen, Guangdong, PRC | PO Box 3534 Paarl 7620 South Africa |
| Tel | +1 512 538 1995 | +86 755 8303 5294 ext 808 | +27 21 863 0033 |
| Email | info@azoteq.com | info@azoteq.com | info@azoteq.com |

*Visit www.azoteq.com
for a list of distributors and worldwide representation.*

Patents as listed on www.azoteq.com/patents-trademarks/ may relate to the device or usage of the device.

Azoteq®, Crystal Driver®, IQ Switch®, ProxSense®, ProxFusion®, LightSense™, SwipeSwitch™, and the  logo are trademarks of Azoteq.

The information in this Datasheet is believed to be accurate at the time of publication. Azoteq uses reasonable effort to maintain the information up-to-date and accurate, but does not warrant the accuracy, completeness or reliability of the information contained herein. All content and information are provided on an “as is” basis only, without any representations or warranties, express or implied, of any kind, including representations about the suitability of these products or information for any purpose. Azoteq disclaims all warranties and conditions with regard to these products and information, including but not limited to all implied warranties and conditions of merchantability, fitness for a particular purpose, title and non-infringement of any third party intellectual property rights. Azoteq assumes no liability for any damages or injury arising from any use of the information or the product or caused by, without limitation, failure of performance, error, omission, interruption, defect, delay in operation or transmission, even if Azoteq has been advised of the possibility of such damages. The applications mentioned herein are used solely for the purpose of illustration and Azoteq makes no warranty or representation that such applications will be suitable without further modification, nor recommends the use of its products for application that may present a risk to human life due to malfunction or otherwise. Azoteq products are not authorized for use as critical components in life support devices or systems. No licenses to patents are granted, implicitly, express or implied, by estoppel or otherwise, under any intellectual property rights. In the event that any of the abovementioned limitations or exclusions does not apply, it is agreed that Azoteq’s total liability for all losses, damages and causes of action (in contract, tort (including without limitation, negligence) or otherwise) will not exceed the amount already paid by the customer for the products. Azoteq reserves the right to alter its products, to make corrections, deletions, modifications, enhancements, improvements and other changes to the content and information, its products, programs and services at any time or to move or discontinue any contents, products, programs or services without prior notification. For the most up-to-date information and binding Terms and Conditions please refer to www.azoteq.com.