

# Using the TPS53317EVM-750

## User's Guide



Literature Number: SLUU642  
September 2011

# ***TPS53317EVM-750 D-CAP+™ Mode Synchronous Step-Down Integrated FETs Converter***

---

---

---

## **1 Introduction**

The TPS53317EVM-750 evaluation module (EVM) is a synchronous buck regulator featuring TPS53317. The TPS53317 is a fully integrated synchronous buck regulator employing D-CAP+™ technology.

## **2 Description**

The TPS53317EVM-750 is designed to use a 1.5-V voltage rail to produce a regulated 0.75-V or use a 1.35-V voltage rail to produce a regulated 0.675-V output at up to 6-A load current. The TPS53317EVM-750 is designed to demonstrate the TPS53317 in a typical low voltage application while providing a number of test points to evaluate the performance of the TPS53317.

### **2.1 Typical Applications**

- VTT Terminators
- Low-Voltage Applications for 1-V to 6-V Step-Down Rails

### **2.2 Features**

The TPS53317EVM-750 features:

- Integrated Droop Support
- External Tracking Support
- Selectable Switching Frequency Settings (600 kHz and 1 MHz)
- Selectable Light-Load Operation Modes (auto-skip and forced CCM)
- Selectable Valley Overcurrent Limit
- PGOOD Function
- Convenient Test Points for Probing Critical Waveforms

### 3 Electrical Performance Specifications

**Table 1. TPS53317EVM-750 Electrical Performance Specifications<sup>(1)</sup>**

PARAMETER	TEST CONDITIONS	MIN	TYP	MAX	UNITS
<b>Input Characteristics</b>					
Voltage range	$V_{IN}$	1.4	1.5	1.6	V
Maximum input current	$V_{IN} = 1.5\text{ V}$ , $I_{OUT} = 6\text{ A}$		4		A
No load input current	$V_{IN} = 1.5\text{ V}$ , $I_{OUT} = 0\text{ A}$ under skip mode, $f_{SW} = 600\text{ kHz}$		1		mA
<b>Output Characteristics</b>					
Output voltage			0.75		V
Output voltage regulation	Setpoint accuracy ( $V_{IN} = 1.5\text{ V}$ , $I_{OUT} = 0\text{ A}$ , non-droop)	-2%		2%	
	Line regulation ( $V_{IN} = 1.4\text{ V} - 1.6\text{ V}$ , $I_{OUT} = 6\text{ A}$ , non-droop, $f_{SW} = 600\text{ kHz}$ )			0.1%	
	Load regulation, ( $V_{IN} = 1.5\text{ V}$ , $I_{OUT} = 0\text{ A} - 6\text{ A}$ , non-droop, $f_{SW} = 600\text{ kHz}$ )			0.5%	
Output voltage ripple	$V_{IN} = 1.5\text{ V}$ , $I_{OUT} = 6\text{ A}$		10		mVpp
Output load current		0		6	A
Over current limit valley			7.6/5.4		
<b>Systems Characteristics</b>					
Switching frequency			600/1000		kHz
Peak efficiency	$V_{IN} = 1.5\text{ V}$ , $I_{OUT} = 1.6\text{ A}$ under skip mode, $f_{SW} = 600\text{ kHz}$		89.8%		
Full load efficiency	$V_{IN} = 1.5\text{ V}$ , $I_{OUT} = 6\text{ A}$ under skip mode, $f_{SW} = 600\text{ kHz}$		82.3%		
Operating temperature			25		°C

<sup>(1)</sup> Jumpers set to default locations, See section 6 of this user's guide

4 Schematic

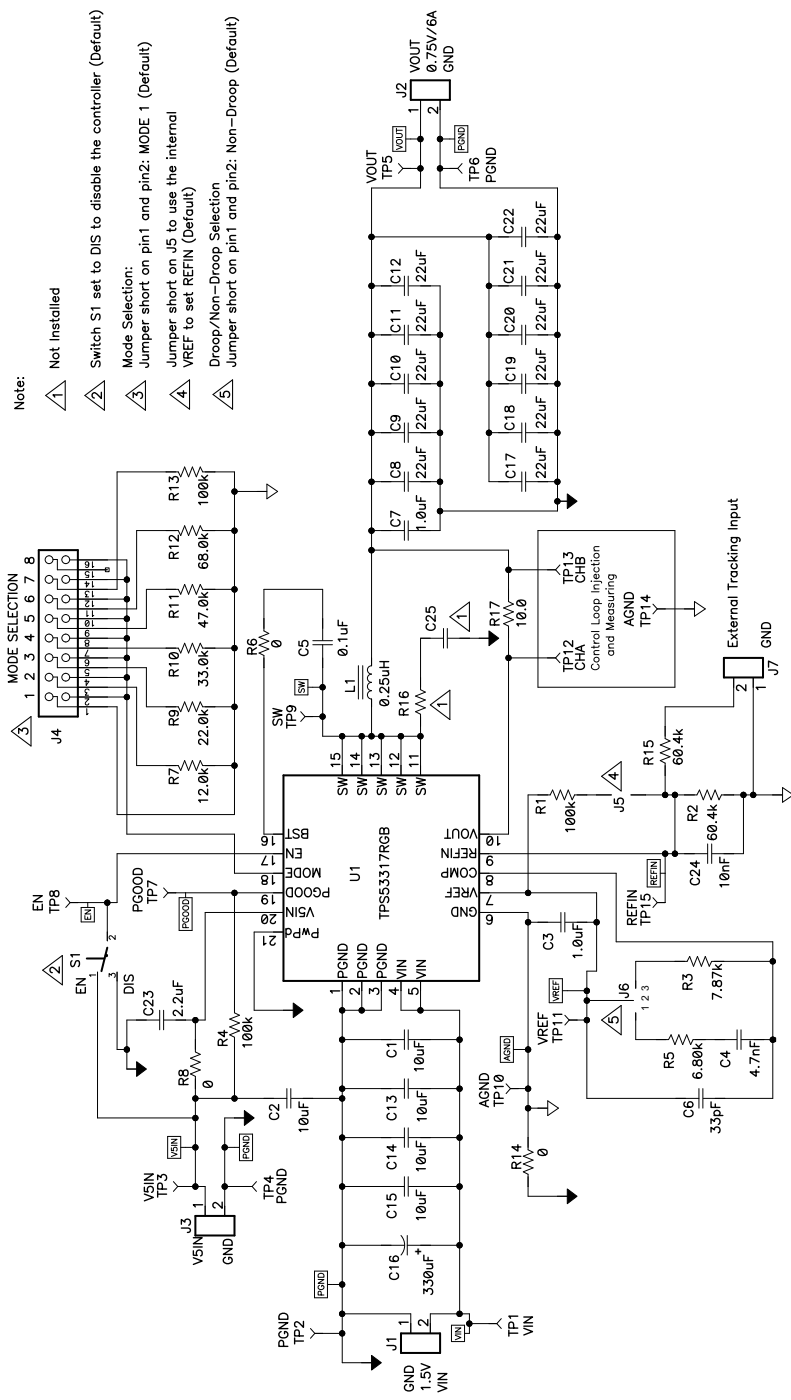

Figure 1. TPS53317EVM-750 Schematic

## 5 Test Setup

### 5.1 Test Equipment

#### Voltage Source:

- **VIN:** The input voltage source VIN should be a 0-V to 5-V variable DC source capable of supplying 10 A<sub>DC</sub>. Connect VIN to J1 as shown in [Figure 3](#).
- **V5IN:** The V5IN voltage source should be a 5-V DC source capable of supplying 1 A<sub>DC</sub>. Connect V5IN to J3 as shown in [Figure 3](#).

#### Multimeters:

- **V1:** VIN at TP1 (VIN) and TP2 (PGND), 0-V to 5-V voltmeter
- **V2:** VOUT at TP5 (VOUT) and TP6 (PGND)
- **V3:** V5IN at TP3 (V5IN) and TP4 (PGND)
- **A1:** VIN input current, 0 A<sub>DC</sub> to 10 A<sub>DC</sub> Ammeter
- **A2:** V5IN supply current, 0 A<sub>DC</sub> to 1 A<sub>DC</sub> Ammeter

**Output Load:** The output load should be an electronic constant resistance mode load capable of 0 A<sub>DC</sub> to 10 A<sub>DC</sub>

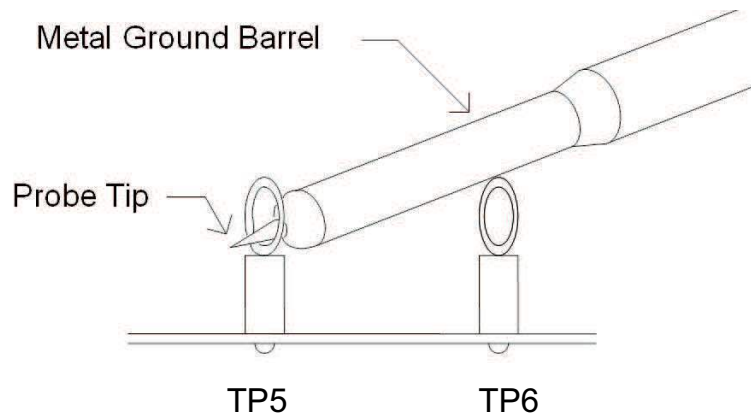

**Figure 2. Tip and Barrel Measurement for VOUT Ripple**

**Fan:** Some of the components in this EVM may approach temperatures of 55°C during operation. A small fan capable of 200 LFM to 400 LFM is recommended to reduce component temperatures while the EVM is operating. The EVM should not be probed while the fan is not running.

#### Recommended Wire Gauge:

- **VIN to J1 (1.5-V input):** The recommended wire size is 1x AWG #14 per input connection, with the total length of wire less than 4 feet (2 feet input, 2 feet return).
- **J2 to LOAD:** The minimum recommended wire size is 1x AWG #14, with the total length of wire less than 4 feet (2-feet output, 2-feet return)
- **V5IN to J3 (5-V input):** The recommended wire size is 1x AWG #16 per input connection, with the total length of wire less than 4 feet (2-feet input, 2-feet return).

## 5.2 Recommended Test Setup

Figure 3 is the recommended test set up to evaluate the TPS53317EVM-750. Working at an ESD workstation, make sure that any wrist straps, bootstraps or mats are connected referencing the user to earth ground before power is applied to the EVM.

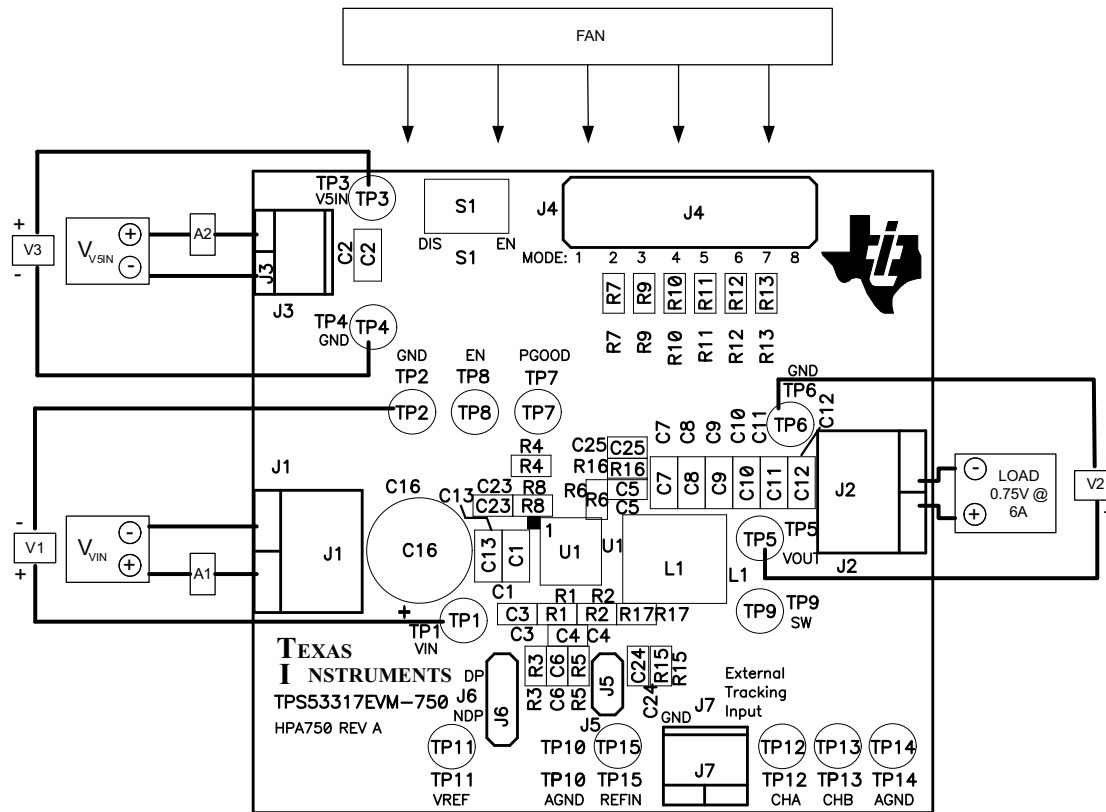

Figure 3. TPS53317EVM-750 Recommended Test Set Up

### Input Connections:

1. Prior to connecting the DC input source VIN, it is advisable to limit the source current from VIN to 10 A maximum. Make sure VIN is initially set to 0 V and connected to J1 as shown in Figure 3.
2. Connect a current meter A1 between VIN and J1 to measure the input current.
3. Connect a voltmeter V1 at TP1 (VIN) and TP2 (PGND) to measure the input voltage.
4. Prior to connecting the 5-V DC source V5IN, it is advisable to limit the source current from V5IN to 1 A maximum. Make sure V5IN is initially set to 0 V and connected to J3 as shown in Figure 3.
5. Connect a current meter A2 to measure the 5-V supply current.
6. Connect a voltmeter V3 at TP3 (V5IN) and TP4 (PGND) to measure the V5IN voltage.

### Output Connections:

1. Connect Load to J2 and set Load to constant resistance mode to sink 0 A<sub>DC</sub> before VIN is applied.
2. Connect a voltmeter V2 at TP5 (VOUT) and TP6 (PGND) to measure the output voltage.

**Other Connections:** Place a Fan as shown in Figure 3 and turn on, making sure air is flowing across the EVM.

## 6 Configurations

All Jumper selections should be made prior to applying power to the EVM. User can configure this EVM per following configurations.

### 6.1 Mode Selection

The MODE can be set by J4.

#### 6.1.1 Default setting: MODE1

**Table 2. MODE Selection**

JUMPER SET TO	MODE	MODE RESISTANCES (kΩ)	LIGHT-LOAD POWER SAVING MODE	SWITCHING FREQUENCY (kHz)	OVERCURRENT LIMIT (OCL) VALLEY (A)
1 <sup>st</sup> (1-2 pin shorted)	1	0	Skip	600	7.6
2 <sup>nd</sup> (3-4 pin shorted)	2	12		600	5.4
3 <sup>rd</sup> (5-6 pin shorted)	3	22		1000	5.4
4 <sup>th</sup> (7-8 pin shorted)	4	33		1000	7.6
5 <sup>th</sup> (9-10 pin shorted)	5	47	PWM	600	7.6
6 <sup>th</sup> (11-12 pin shorted)	6	68		600	5.4
7 <sup>th</sup> (13-14 pin shorted)	7	100		1000	5.4
8 <sup>th</sup> (15-16 pin shorted)	8	Open		1000	7.6

### 6.2 Droop/Non-droop Configuration

The droop function can be configured by J6.

#### 6.2.1 Default setting: Non-Droop

**Table 3. Droop Configuration**

JUMPER SET TO	DROOP CONFIGURATION
Top(1-2 pin shorted)	Droop
Bottom(2-3 pin shorted)	Non-droop

### 6.3 External Tracking Selection

The external tracking can be configured by J5. If jumper J5 is shorted, the internal 2-V VREF voltage is used to set the target output voltage to be 0.75 V. If jumper J5 is open, the external reference between 1.2 V to 4.0 V can be applied to J7. The output voltage will be regulated to  $\frac{1}{2}$  of the external reference voltage. For example, applying 1.35 V to J7, the output voltage is 0.675 V.

#### 6.3.1 Default setting: No External Tracking

**Table 4. External Tracking Configuration**

JUMPER SET TO	EXTERNAL TRACKING CONFIGURATION
Short	No external tracking
Open	External tracking

### 6.4 Enable Selection

The controller can be enabled and disabled by S1.

#### 6.4.1 Default setting: Switch to disable the controller

**Table 5. Enable Selection**

SWITCH SET TO	ENABLE SELECTION
DIS	Disable the controller
EN	Enable the controller

## 7 Test Procedure

### 7.1 Line/Load Regulation and Efficiency Measurement Procedure

1. Set up EVM as described in [Figure 3](#).
2. Ensure Load is set to constant resistance mode and to sink 0 A<sub>DC</sub>.
3. Ensure all jumpers and switch configuration settings per [Section 6](#).
4. Increase V5IN from 0 V to 5 V. Using V3 to measure V5IN voltage.
5. Increase VIN from 0 V to 1.5 V. Using V1 to measure VIN voltage.
6. Set switch S1 to EN to enable the controller.
7. Use V2 to measure VOUT voltage, A1 to measure VIN current and A2 to measure V5IN supply current.
8. Vary Load from 0 A<sub>DC</sub> to 3 A<sub>DC</sub>, VOUT should remain in load regulation.
9. Vary VIN from 1.4 V to 1.6 V, VOUT should remain in line regulation.
10. Set switch S1 to DIS to disable the controller.
11. Decrease Load to 0 A.
12. Decrease VIN to 0 V.
13. Decrease V5IN to 0 V.



## 7.2 Control Loop Gain and Phase Measurement Procedure

TPS53317EVM-750 contains a 10-Ω series resistor in the feedback loop for loop response analysis.

1. Set up EVM as described in [Figure 3](#).
2. Connect isolation transformer to test points marked TP12 and TP13.
3. Connect input signal amplitude measurement probe (channel A) to TP12. Connect output signal amplitude measurement probe (channel B) to TP13.
4. Connect ground lead of channel A and channel B to TP14.
5. Inject around 40 mV or less signal through the isolation transformer.
6. Sweep the frequency from 500 Hz to 500 kHz with 10 Hz or lower post filter. The control loop gain and phase margin can be measured.
7. Disconnect isolation transformer from bode plot test points before making other measurements (signal injection into feedback may interfere with accuracy of other measurements).

## 7.3 List of Test Points

**Table 6. The Functions of Each Test Points**

TEST POINTS	NAME	DESCRIPTION
TP1	VIN	Input voltage
TP2	PGND	PGND for VIN
TP3	V5IN	5-V power supply for analog circuits and gate drive
TP4	PGND	PGND for V5IN
TP5	VOUT	Output voltage
TP6	PGND	PGND for VOUT
TP7	PGOOD	Power good
TP8	EN	Enable pin
TP9	SW	Switching node
TP10	AGND	Signal ground
TP11	VREF	Internal 2-V reference voltage output
TP12	CHA	Input A for loop injection
TP13	CHB	Input B for loop injection
TP14	AGND	Signal ground
TP15	REFIN	Target output voltage input

## 7.4 Equipment Shutdown

1. Shut down VIN
2. Shut down V5IN
3. Shut down Load
4. Shut down FAN

## 8 Performance Data and Typical Characteristic Curves

Figure 4 through Figure 16 present typical performance curves for TPS53317EVM-750.

### 8.1 Efficiency

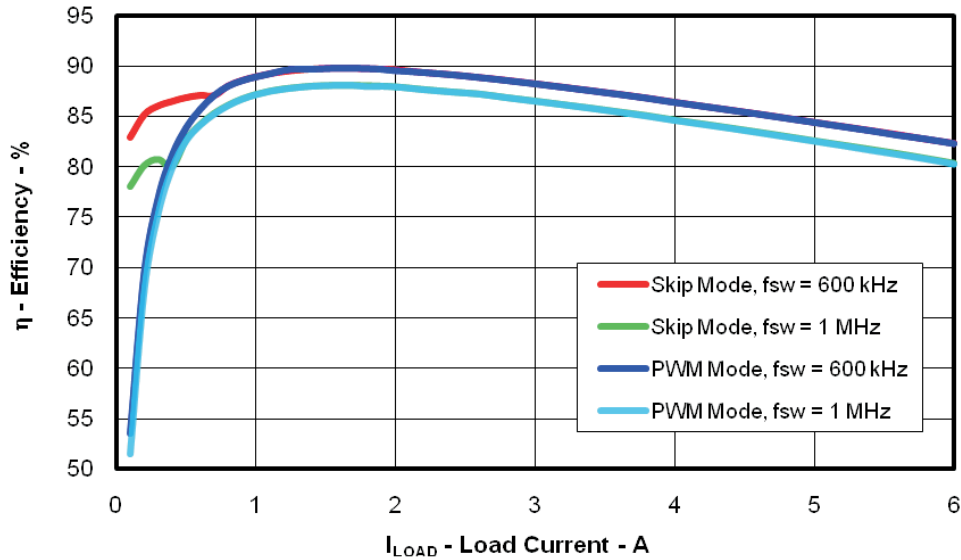

Figure 4. Efficiency

### 8.2 Load Regulation

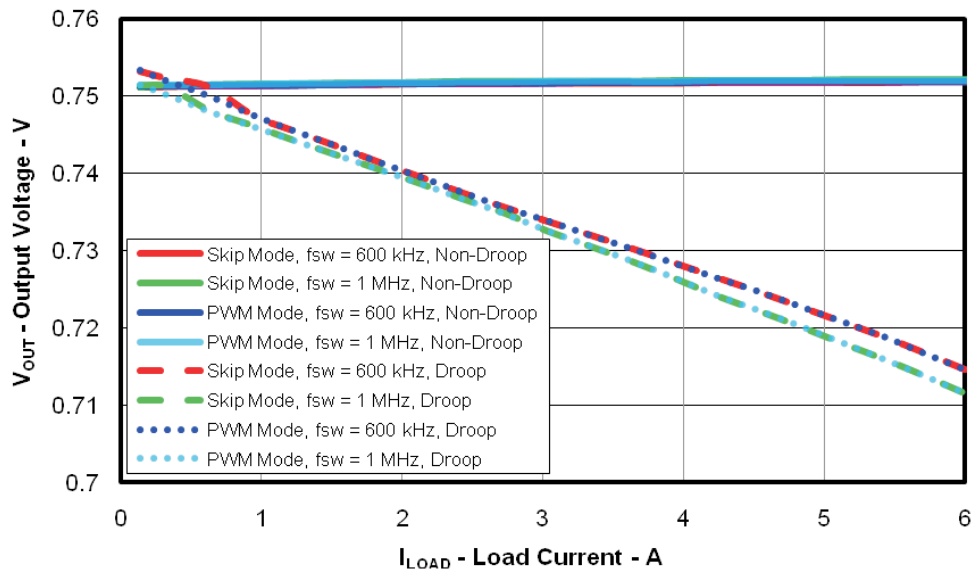
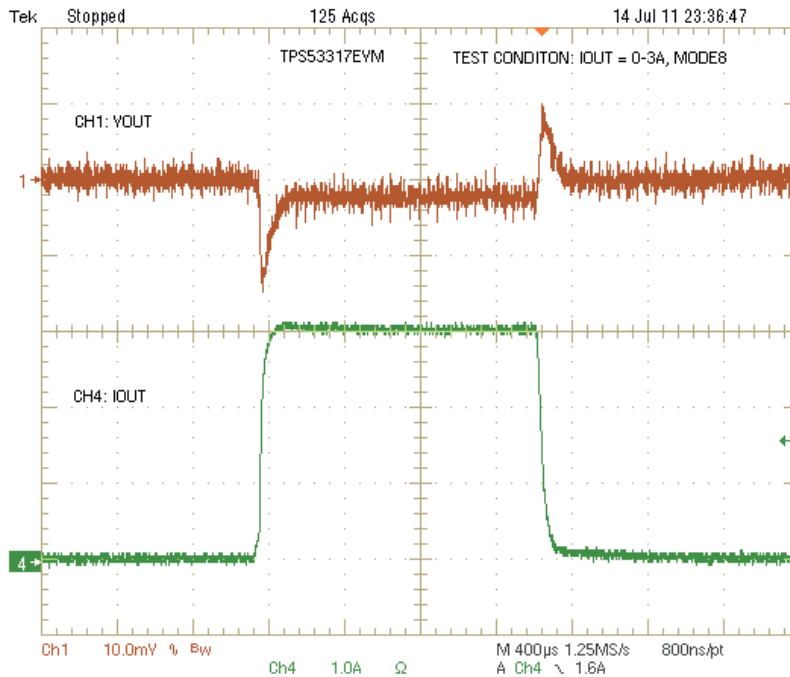
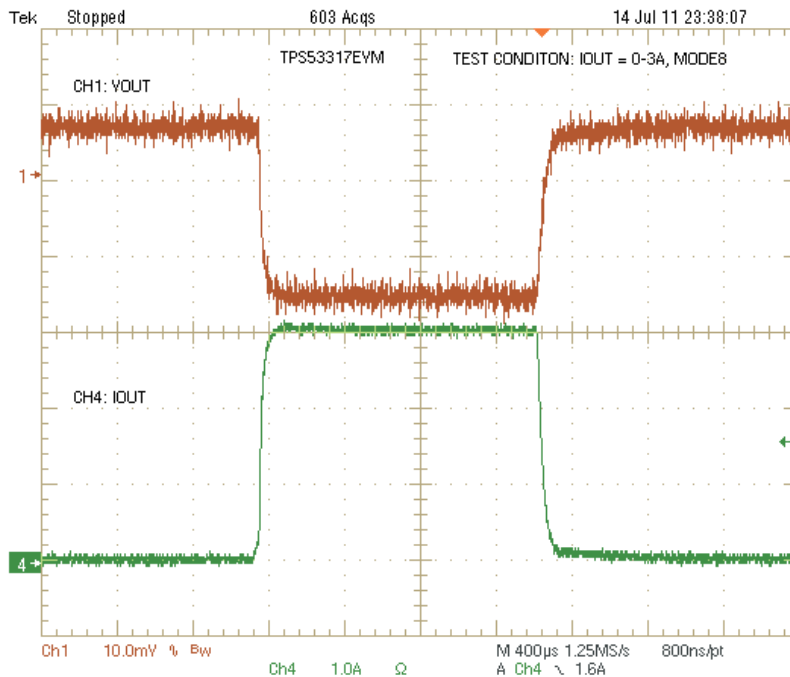

Figure 5. Load Regulation

### 8.3 Output Transient

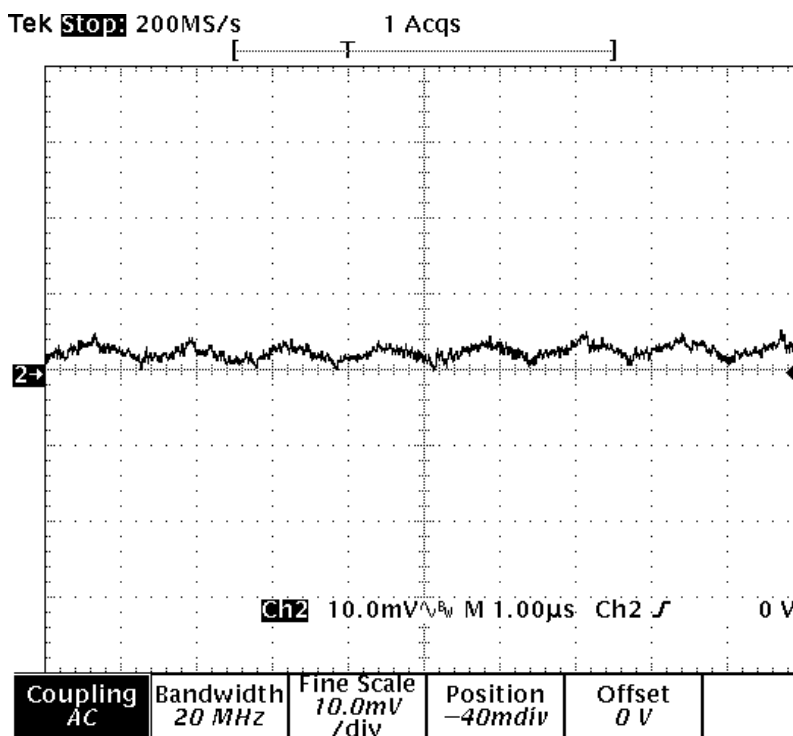

**Figure 6. Output Load 0-A to 3-A Transient**  
 (1.5-V  $V_{IN}$ , 0.75-V  $V_{OUT}$ , PWM mode,  $f_{SW} = 1$  MHz)

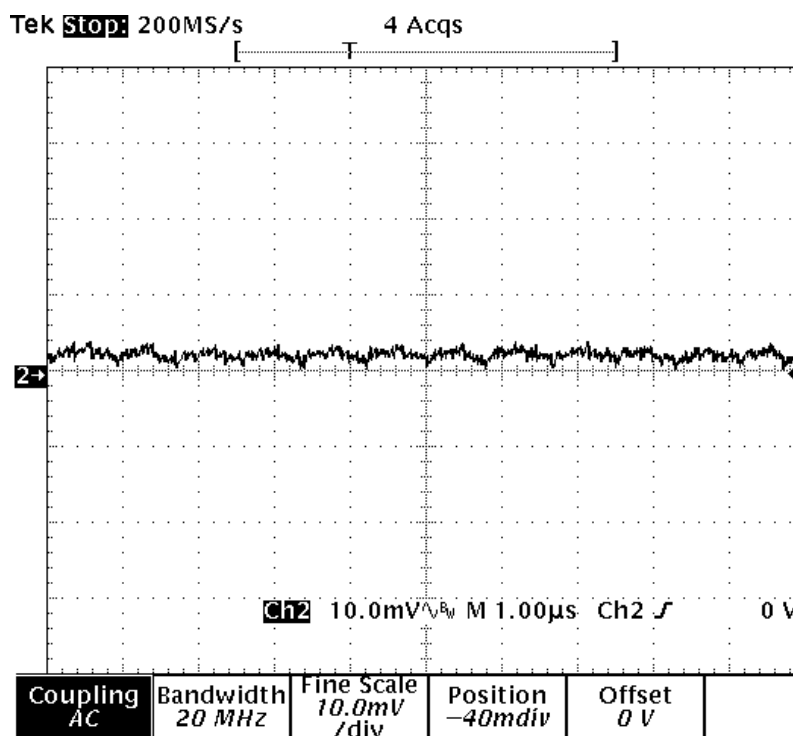

**Figure 7. Output Load 0-A to 3-A Transient with Droop**  
 (1.5-V  $V_{IN}$ , 0.75-V  $V_{OUT}$ , PWM mode,  $f_{SW} = 1$  MHz)

### 8.4 Output Ripple

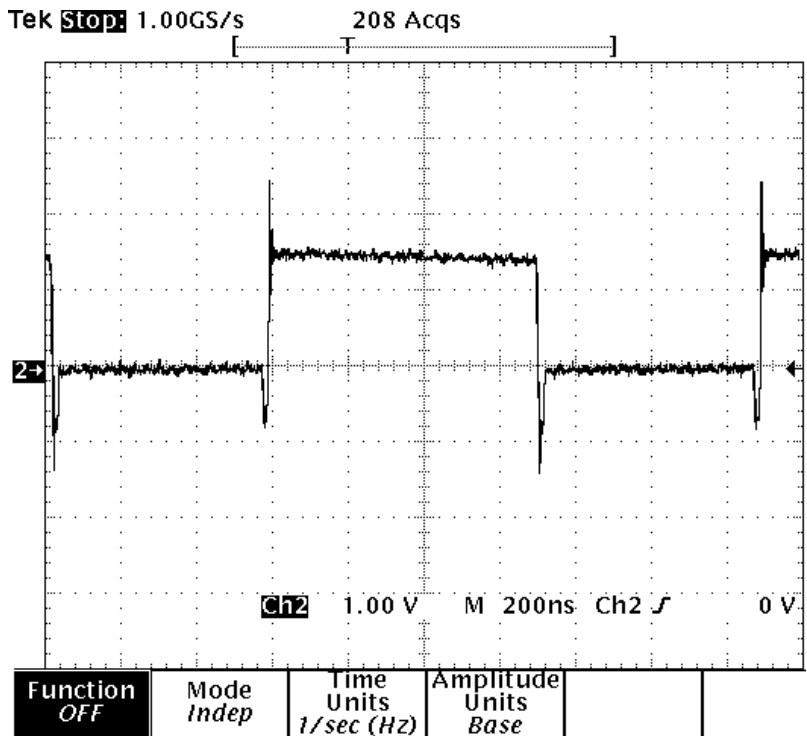

**Figure 8. Output Ripple**  
(1.5-V  $V_{IN}$ , 0.75-V  $V_{OUT}$ , 3-A  $I_{OUT}$ ,  $f_{SW} = 600$  kHz)

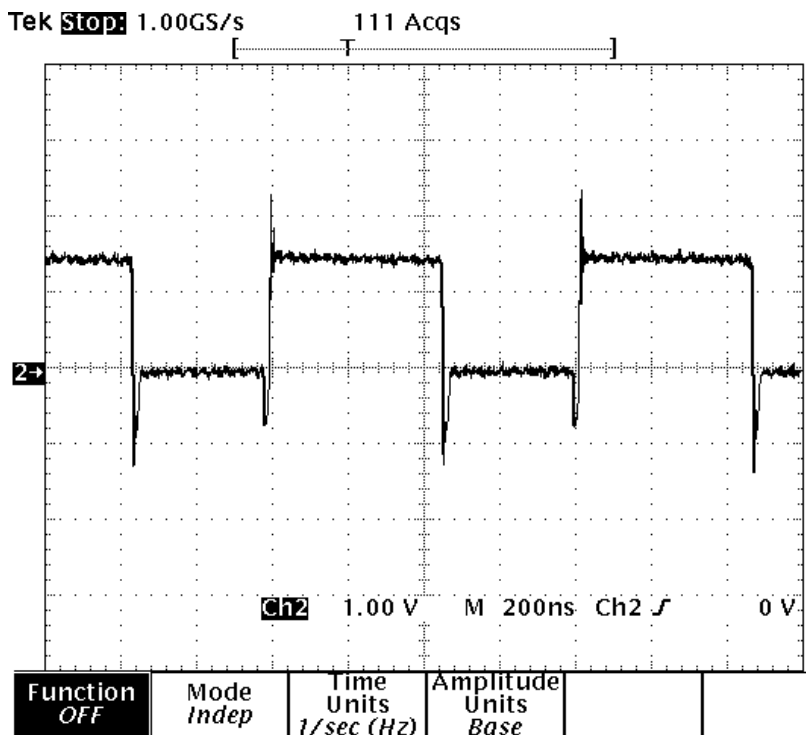

**Figure 9. Output Ripple**  
(1.5-V  $V_{IN}$ , 0.75-V  $V_{OUT}$ , 3-A  $I_{OUT}$ ,  $f_{SW} = 1$  MHz)

### 8.5 Switching Node

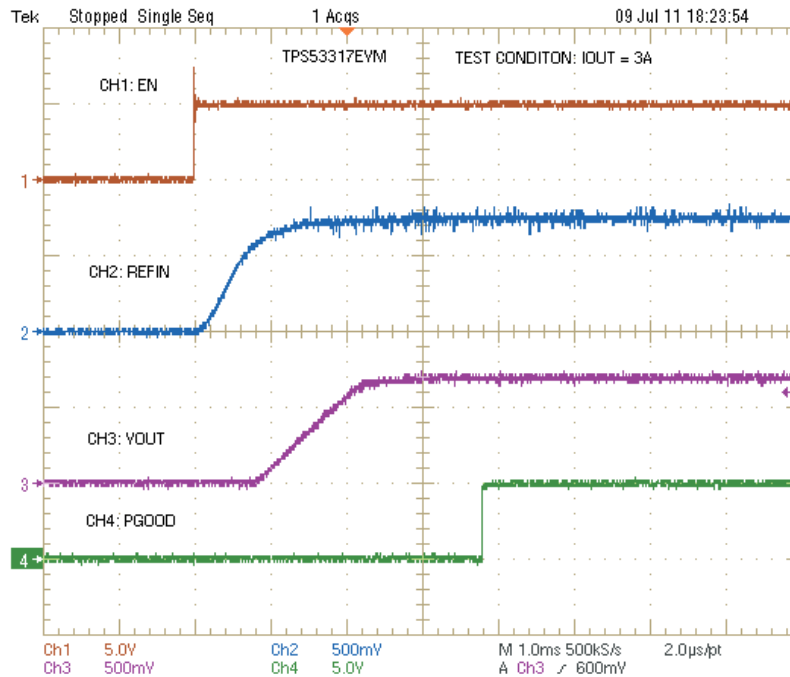

**Figure 10. Switching Node**  
(1.5-V  $V_{IN}$ , 0.75-V  $V_{OUT}$ , 3-A  $I_{OUT}$ ,  $f_{SW} = 600$  kHz)

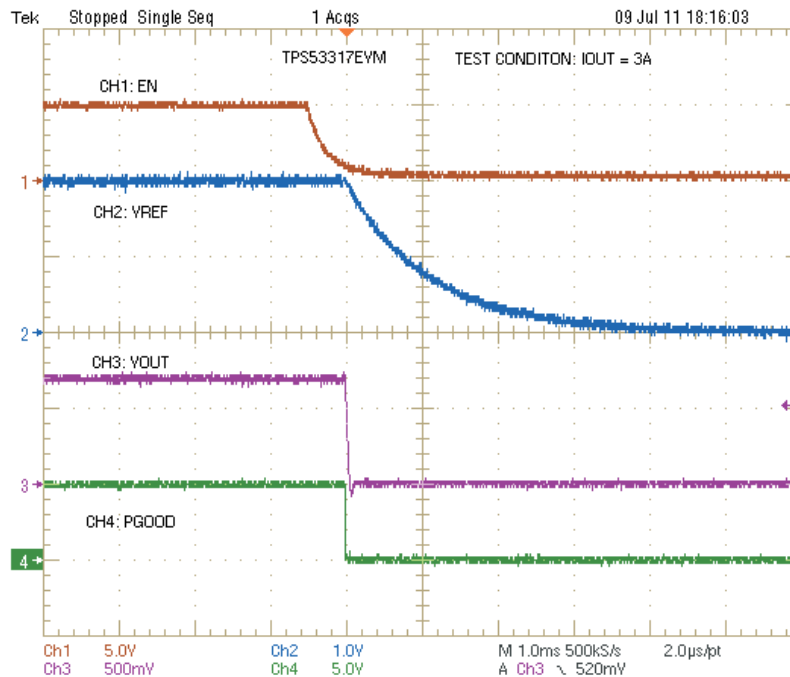

**Figure 11. Switching Node**  
(1.5-V  $V_{IN}$ , 0.75-V  $V_{OUT}$ , 3-A  $I_{OUT}$ ,  $f_{SW} = 1$  MHz)

### 8.6 Enable Turn On / Turn Off



**Figure 12. Turn-On Waveform**  
(1.5-V  $V_{IN}$ , 0.75-V  $V_{OUT}$ , 3-A  $I_{OUT}$ )



**Figure 13. Turn-Off Waveform**  
(1.5-V  $V_{IN}$ , 0.75-V  $V_{OUT}$ , 3-A  $I_{OUT}$ )

### 8.7 Pre-bias Turn-On

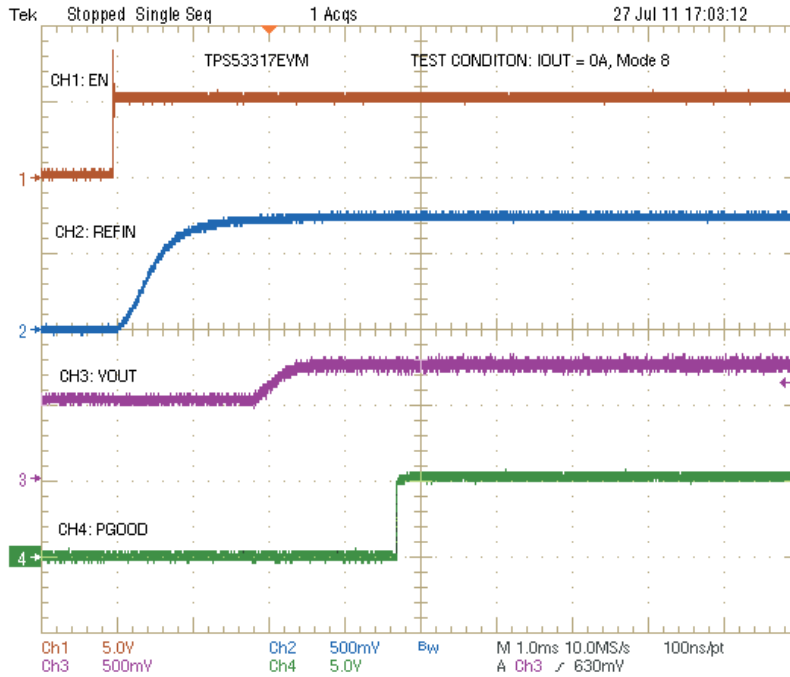

Figure 14. Pre-bias Turn-On Waveform (1.5-V  $V_{IN}$ , 0.75-V  $V_{OUT}$ , 0-A  $I_{OUT}$ , 0.5-V pre-bias)

### 8.8 Bode Plot

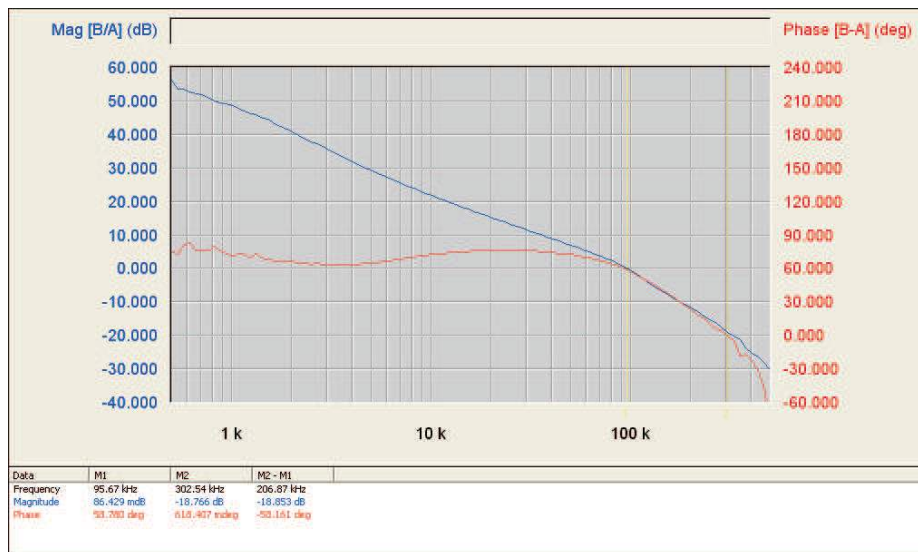
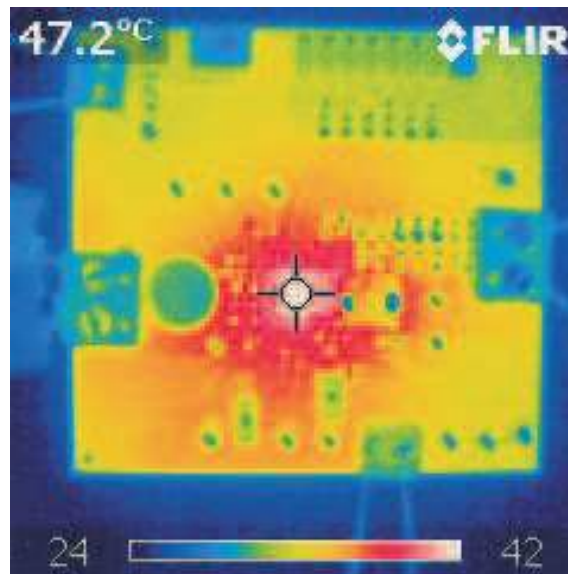

Figure 15. Loop Gain (1.5-V  $V_{IN}$ , 0.75-V  $V_{OUT}$ , 3-A  $I_{OUT}$ , skip mode,  $f_{SW} = 1$  MHz, non-droop)

## 8.9 Thermal Image



**Figure 16. Thermal Image**  
 (1.5-V  $V_{IN}$ , 0.75-V  $V_{OUT}$ , 6-A  $I_{OUT}$ , PWM mode,  $f_{SW} = 1$  MHz)



## 9 EVM Assembly Drawing and PCB Layout

The following figures (Figure 17 through Figure 22) show the design of the TPS53317EVM-750 printed circuit board. The EVM has been designed using 4-Layers, 2-oz copper circuit board.

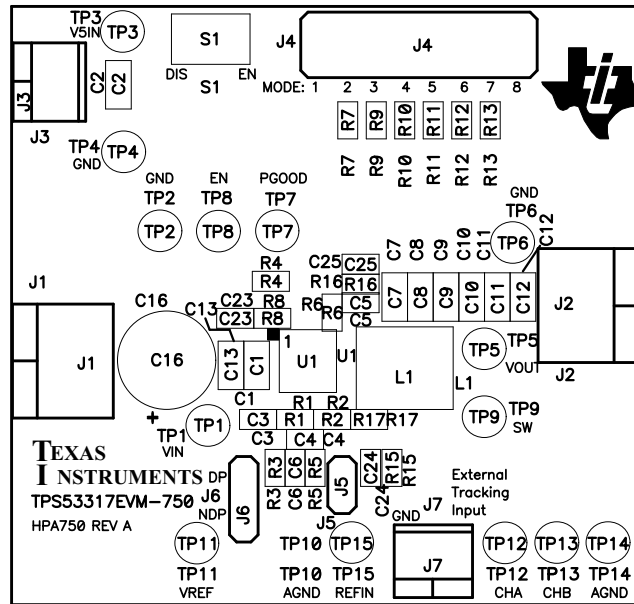

Figure 17. TPS53317EVM-750 Top Layer Assembly Drawing (top view)

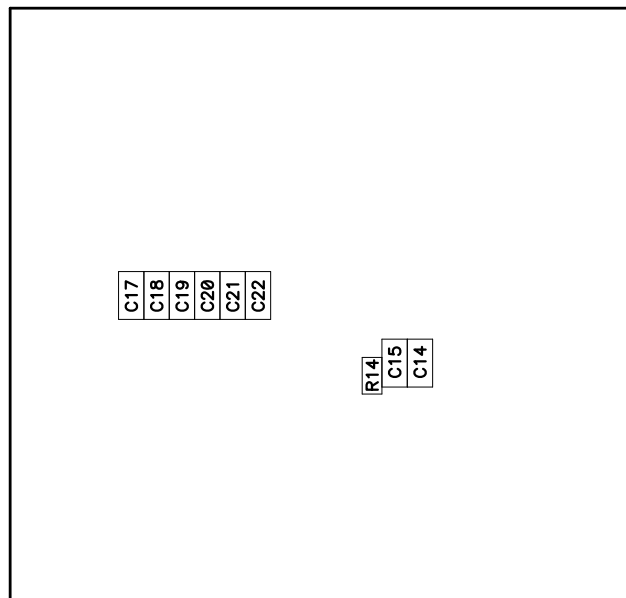
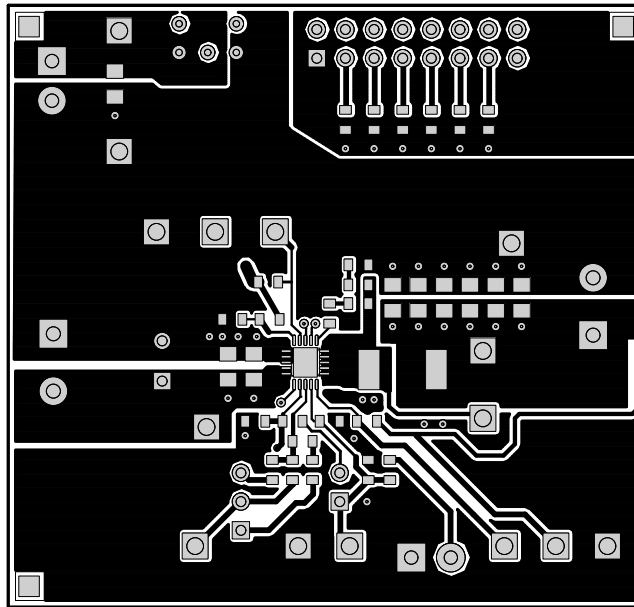
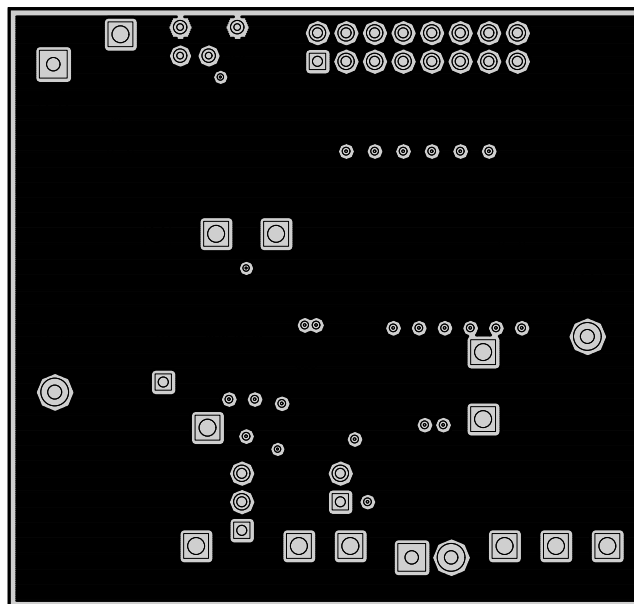

Figure 18. TPS53317EVM-750 Bottom Assembly Drawing (bottom view)



**Figure 19. TPS53317EVM-750 Top Copper (top view)**



**Figure 20. TPS53317EVM-750 Layer 2 (top view)**

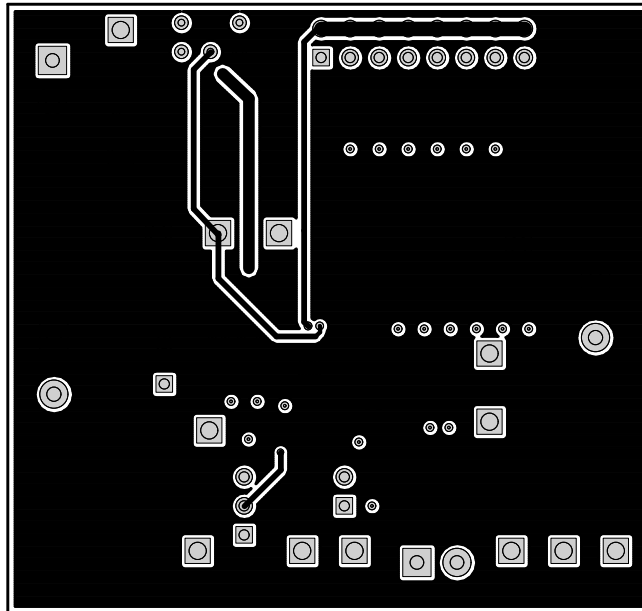

Figure 21. TPS53317EVM-750 Layer 3 (top view)

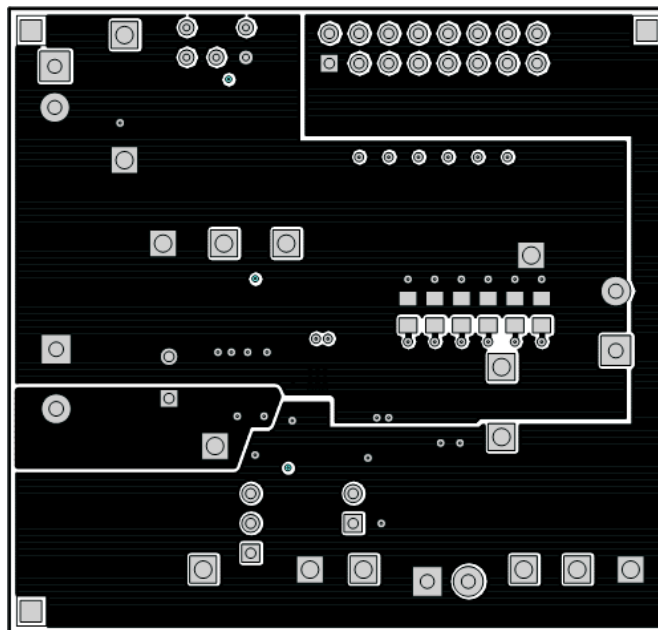

Figure 22. TPS53317EVM-750 Bottom Layer (top view)

## 10 List of Materials

The EVM components list according to the schematic Shown in [Figure 1](#)

**Table 7. TPS53317EVM-750 List of Materials**

QTY	REF DES	DESCRIPTION	PART NUMBER	MFR
5	C1, C2, C13, C14, C15	Capacitor, ceramic, 16 V, x5R, 10%, 10 $\mu$ F, 0805	Std	Std
1	C16	Capacitor, OS CON, 10 V, 17 milliohm, 20%, 330uF, 0.315 inch	10SEP330M	Sanyo
1	C3	Capacitor, ceramic, 16 V, x7R, 20%, 1.0 $\mu$ F, 0603	Std	Std
1	C35	Capacitor, ceramic, 16 V, x5R, 20%, 2.2 $\mu$ F, 0603	Std	Std
1	C37	Capacitor, ceramic, 16 V, x7R, 10%, 10 nF, 0603	Std	Std
0	C38	Capacitor, ceramic, 16 V, x7R, 10%, 0603	Std	Std
1	C4	Capacitor, ceramic, 50 V, x7R, 10%, 4.7 nF, 0603	Std	Std
1	C5	Capacitor, ceramic, 16 V, x7R, 10%, 0.1 $\mu$ F, 0603	Std	Std
1	C6	Capacitor, ceramic, 16 V, x7R, 10%, 33 pF, 0603	Std	Std
1	C7	Capacitor, ceramic, 10 V, x7R, 20%, 1.0 $\mu$ F, 0805	Std	Std
11	C8, C9, C10, C11, C12, C22, C28, C29, C30, C31, C32	Capacitor, ceramic, 6.3 V, x5R, 20%, 22 $\mu$ F, 0805	Std	Std
2	J1, J2	Terminal block, 2 pin, 15 A, 5.1 mm, 0.40 inch x 0.35 inch	ED120/2DS	OST
2	J3, J7	Terminal block, 2 pin, 6 A, 3.5 mm, 0.27 inch x 0.25 inch	ED555/2DS	OST
1	J4	Header, male 2 x 8 pin, 100-mil spacing, 0.100 inch x 2 inch x 8 inch	PEC08DAAN	Sullins
1	J5	Header, male 2 pin, 100-mil spacing, 0.100 inch x 2	PEC02SAAN	Sullins
1	J6	Header, male 3 pin, 100-mil spacing, 0.100 inch x 3	PEC03SAAN	Sullins
1	L1	Inductor, SMT, 23 A, 2.1 m $\Omega$ , 0.25 $\mu$ H, 0.256 inch x 0.280 inch	SPM6530T-R25M230	TDK
3	R1, R4, R13	Resistor, chip, 1/16 W, 1%, 100 k $\Omega$ , 0603	Std	Std
1	R10	Resistor, chip, 1/16 W, 1%, 33.0 k $\Omega$ , 0603	Std	Std
1	R11	Resistor, chip, 1/16 W, 1%, 47.0 k $\Omega$ , 0603	Std	Std
1	R12	Resistor, chip, 1/16 W, 1%, 68.0 k $\Omega$ , 0603	Std	Std
2	R2, R15	Resistor, chip, 1/16 W, 1%, 60.4 k $\Omega$ , 0603	Std	Std
0	R21	Resistor, chip, 1/8 W, 1%, 0603	Std	Std
1	R28	Resistor, chip, 1/16 W, 1%, 10.0 $\Omega$ , 0603	Std	Std
1	R3	Resistor, chip, 1/16 W, 1%, 7.87 k $\Omega$ , 0603	Std	Std
1	R5	Resistor, chip, 1/16 W, 1%, 6.80 k $\Omega$ , 0603	Std	Std
3	R6, R8, R14	Resistor, chip, 1/16 W, 5%, 0 $\Omega$ , 0603	Std	Std
1	R7	Resistor, chip, 1/16 W, 1%, 12.0 k $\Omega$ , 0603	Std	Std
1	R9	Resistor, chip, 1/16 W, 1%, 22.0 k $\Omega$ , 0603	Std	Std

**Table 7. TPS53317EVM-750 List of Materials (continued)**

QTY	REF DES	DESCRIPTION	PART NUMBER	MFR
1	S1	Switch, ON-ON mini toggle, 0.28 inch x 0.18 inch	G12AP-RO	NKK
1	TP1	Test point, 0.062 hole, VIN, 0.250 inch	5010	Keystone
2	TP10, TP14	Test point, 0.062 hole, AGND, 0.250 inch	5011	Keystone
1	TP11	Test point, 0.062 hole, VREF, 0.250 inch	5010	Keystone
1	TP12	Test point, 0.062 hole, CHA, 0.250 inch	5012	Keystone
1	TP13	Test point, 0.062 hole, CHB, 0.250 inch	5012	Keystone
1	TP15	Test point, 0.062 hole, REFIN, 0.250 inch	5010	Keystone
3	TP2, TP4, TP6	Test point, 0.062 hole, PGND, 0.250 inch	5011	Keystone
1	TP3	Test point, 0.062 hole, V5IN, 0.250 inch	5010	Keystone
1	TP5	Test point, 0.062 hole, VOUT, 0.250 inch	5010	Keystone
1	TP7	Test point, 0.062 hole, PGOOD, 0.250 inch	5012	Keystone
1	TP8	Test point, 0.062 hole, EN, 0.250 inch	5012	Keystone
1	TP9	Test point, 0.062 hole, SW, 0.250 inch	5010	Keystone
1	U1	3.3-V/5-V Input, 6-A, D-CAP+™ Mode Synchronous Step-Down Integrated FETs Converter, QFN-20	TPS53317RGB	TI
3	--	Shunt, 100 mil, black, 0.100	929950-00	3M
1	--	PCB, 2.225 inch x 2.1 inch x 0.062 inch	HPA750	Any

## Evaluation Board/Kit Important Notice

Texas Instruments (TI) provides the enclosed product(s) under the following conditions:

This evaluation board/kit is intended for use for **ENGINEERING DEVELOPMENT, DEMONSTRATION, OR EVALUATION PURPOSES ONLY** and is not considered by TI to be a finished end-product fit for general consumer use. Persons handling the product(s) must have electronics training and observe good engineering practice standards. As such, the goods being provided are not intended to be complete in terms of required design-, marketing-, and/or manufacturing-related protective considerations, including product safety and environmental measures typically found in end products that incorporate such semiconductor components or circuit boards. This evaluation board/kit does not fall within the scope of the European Union directives regarding electromagnetic compatibility, restricted substances (RoHS), recycling (WEEE), FCC, CE or UL, and therefore may not meet the technical requirements of these directives or other related directives.

Should this evaluation board/kit not meet the specifications indicated in the User's Guide, the board/kit may be returned within 30 days from the date of delivery for a full refund. **THE FOREGOING WARRANTY IS THE EXCLUSIVE WARRANTY MADE BY SELLER TO BUYER AND IS IN LIEU OF ALL OTHER WARRANTIES, EXPRESSED, IMPLIED, OR STATUTORY, INCLUDING ANY WARRANTY OF MERCHANTABILITY OR FITNESS FOR ANY PARTICULAR PURPOSE.**

The user assumes all responsibility and liability for proper and safe handling of the goods. Further, the user indemnifies TI from all claims arising from the handling or use of the goods. Due to the open construction of the product, it is the user's responsibility to take any and all appropriate precautions with regard to electrostatic discharge.

**EXCEPT TO THE EXTENT OF THE INDEMNITY SET FORTH ABOVE, NEITHER PARTY SHALL BE LIABLE TO THE OTHER FOR ANY INDIRECT, SPECIAL, INCIDENTAL, OR CONSEQUENTIAL DAMAGES.**

TI currently deals with a variety of customers for products, and therefore our arrangement with the user **is not exclusive.**

TI assumes **no liability for applications assistance, customer product design, software performance, or infringement of patents or services described herein.**

Please read the User's Guide and, specifically, the Warnings and Restrictions notice in the User's Guide prior to handling the product. This notice contains important safety information about temperatures and voltages. For additional information on TI's environmental and/or safety programs, please contact the TI application engineer or visit [www.ti.com/esh](http://www.ti.com/esh).

No license is granted under any patent right or other intellectual property right of TI covering or relating to any machine, process, or combination in which such TI products or services might be or are used.

## FCC Warning

This evaluation board/kit is intended for use for **ENGINEERING DEVELOPMENT, DEMONSTRATION, OR EVALUATION PURPOSES ONLY** and is not considered by TI to be a finished end-product fit for general consumer use. It generates, uses, and can radiate radio frequency energy and has not been tested for compliance with the limits of computing devices pursuant to part 15 of FCC rules, which are designed to provide reasonable protection against radio frequency interference. Operation of this equipment in other environments may cause interference with radio communications, in which case the user at his own expense will be required to take whatever measures may be required to correct this interference.

## EVM Warnings and Restrictions

It is important to operate this EVM within the input voltage range of 1.4 V to 1.6 V and the output voltage range of 0.735 V to 0.765 V.

Exceeding the specified input range may cause unexpected operation and/or irreversible damage to the EVM. If there are questions concerning the input range, please contact a TI field representative prior to connecting the input power.

Applying loads outside of the specified output range may result in unintended operation and/or possible permanent damage to the EVM. Please consult the EVM User's Guide prior to connecting any load to the EVM output. If there is uncertainty as to the load specification, please contact a TI field representative.

During normal operation, some circuit components may have case temperatures greater than 55° C. The EVM is designed to operate properly with certain components above 55° C as long as the input and output ranges are maintained. These components include but are not limited to linear regulators, switching transistors, pass transistors, and current sense resistors. These types of devices can be identified using the EVM schematic located in the EVM User's Guide. When placing measurement probes near these devices during operation, please be aware that these devices may be very warm to the touch.

## EVALUATION BOARD/KIT/MODULE (EVM) ADDITIONAL TERMS

Texas Instruments (TI) provides the enclosed Evaluation Board/Kit/Module (EVM) under the following conditions:

The user assumes all responsibility and liability for proper and safe handling of the goods. Further, the user indemnifies TI from all claims arising from the handling or use of the goods.

Should this evaluation board/kit not meet the specifications indicated in the User's Guide, the board/kit may be returned within 30 days from the date of delivery for a full refund. THE FOREGOING LIMITED WARRANTY IS THE EXCLUSIVE WARRANTY MADE BY SELLER TO BUYER AND IS IN LIEU OF ALL OTHER WARRANTIES, EXPRESSED, IMPLIED, OR STATUTORY, INCLUDING ANY WARRANTY OF MERCHANTABILITY OR FITNESS FOR ANY PARTICULAR PURPOSE. EXCEPT TO THE EXTENT OF THE INDEMNITY SET FORTH ABOVE, NEITHER PARTY SHALL BE LIABLE TO THE OTHER FOR ANY INDIRECT, SPECIAL, INCIDENTAL, OR CONSEQUENTIAL DAMAGES.

Please read the User's Guide and, specifically, the Warnings and Restrictions notice in the User's Guide prior to handling the product. This notice contains important safety information about temperatures and voltages. For additional information on TI's environmental and/or safety programs, please visit [www.ti.com/esh](http://www.ti.com/esh) or contact TI.

No license is granted under any patent right or other intellectual property right of TI covering or relating to any machine, process, or combination in which such TI products or services might be or are used. TI currently deals with a variety of customers for products, and therefore our arrangement with the user is not exclusive. TI assumes no liability for applications assistance, customer product design, software performance, or infringement of patents or services described herein.

## REGULATORY COMPLIANCE INFORMATION

As noted in the EVM User's Guide and/or EVM itself, this EVM and/or accompanying hardware may or may not be subject to the Federal Communications Commission (FCC) and Industry Canada (IC) rules.

For EVMs **not** subject to the above rules, this evaluation board/kit/module is intended for use for ENGINEERING DEVELOPMENT, DEMONSTRATION OR EVALUATION PURPOSES ONLY and is not considered by TI to be a finished end product fit for general consumer use. It generates, uses, and can radiate radio frequency energy and has not been tested for compliance with the limits of computing devices pursuant to part 15 of FCC or ICES-003 rules, which are designed to provide reasonable protection against radio frequency interference. Operation of the equipment may cause interference with radio communications, in which case the user at his own expense will be required to take whatever measures may be required to correct this interference.

### General Statement for EVMs including a radio

*User Power/Frequency Use Obligations:* This radio is intended for development/professional use only in legally allocated frequency and power limits. Any use of radio frequencies and/or power availability of this EVM and its development application(s) must comply with local laws governing radio spectrum allocation and power limits for this evaluation module. It is the user's sole responsibility to only operate this radio in legally acceptable frequency space and within legally mandated power limitations. Any exceptions to this are strictly prohibited and unauthorized by Texas Instruments unless user has obtained appropriate experimental/development licenses from local regulatory authorities, which is responsibility of user including its acceptable authorization.

### For EVMs annotated as FCC – FEDERAL COMMUNICATIONS COMMISSION Part 15 Compliant

#### Caution

This device complies with part 15 of the FCC Rules. Operation is subject to the following two conditions: (1) This device may not cause harmful interference, and (2) this device must accept any interference received, including interference that may cause undesired operation.

Changes or modifications not expressly approved by the party responsible for compliance could void the user's authority to operate the equipment.

### FCC Interference Statement for Class A EVM devices

This equipment has been tested and found to comply with the limits for a Class A digital device, pursuant to part 15 of the FCC Rules. These limits are designed to provide reasonable protection against harmful interference when the equipment is operated in a commercial environment. This equipment generates, uses, and can radiate radio frequency energy and, if not installed and used in accordance with the instruction manual, may cause harmful interference to radio communications. Operation of this equipment in a residential area is likely to cause harmful interference in which case the user will be required to correct the interference at his own expense.

### **FCC Interference Statement for Class B EVM devices**

This equipment has been tested and found to comply with the limits for a Class B digital device, pursuant to part 15 of the FCC Rules. These limits are designed to provide reasonable protection against harmful interference in a residential installation. This equipment generates, uses and can radiate radio frequency energy and, if not installed and used in accordance with the instructions, may cause harmful interference to radio communications. However, there is no guarantee that interference will not occur in a particular installation. If this equipment does cause harmful interference to radio or television reception, which can be determined by turning the equipment off and on, the user is encouraged to try to correct the interference by one or more of the following measures:

- Reorient or relocate the receiving antenna.
- Increase the separation between the equipment and receiver.
- Connect the equipment into an outlet on a circuit different from that to which the receiver is connected.
- Consult the dealer or an experienced radio/TV technician for help.

### **For EVMs annotated as IC – INDUSTRY CANADA Compliant**

This Class A or B digital apparatus complies with Canadian ICES-003.

Changes or modifications not expressly approved by the party responsible for compliance could void the user's authority to operate the equipment.

### **Concerning EVMs including radio transmitters**

This device complies with Industry Canada licence-exempt RSS standard(s). Operation is subject to the following two conditions: (1) this device may not cause interference, and (2) this device must accept any interference, including interference that may cause undesired operation of the device.

### **Concerning EVMs including detachable antennas**

Under Industry Canada regulations, this radio transmitter may only operate using an antenna of a type and maximum (or lesser) gain approved for the transmitter by Industry Canada. To reduce potential radio interference to other users, the antenna type and its gain should be so chosen that the equivalent isotropically radiated power (e.i.r.p.) is not more than that necessary for successful communication.

This radio transmitter has been approved by Industry Canada to operate with the antenna types listed in the user guide with the maximum permissible gain and required antenna impedance for each antenna type indicated. Antenna types not included in this list, having a gain greater than the maximum gain indicated for that type, are strictly prohibited for use with this device.

Cet appareil numérique de la classe A ou B est conforme à la norme NMB-003 du Canada.

Les changements ou les modifications pas expressément approuvés par la partie responsable de la conformité ont pu vider l'autorité de l'utilisateur pour actionner l'équipement.

### **Concernant les EVMs avec appareils radio**

Le présent appareil est conforme aux CNR d'Industrie Canada applicables aux appareils radio exempts de licence. L'exploitation est autorisée aux deux conditions suivantes : (1) l'appareil ne doit pas produire de brouillage, et (2) l'utilisateur de l'appareil doit accepter tout brouillage radioélectrique subi, même si le brouillage est susceptible d'en compromettre le fonctionnement.

### **Concernant les EVMs avec antennes détachables**

Conformément à la réglementation d'Industrie Canada, le présent émetteur radio peut fonctionner avec une antenne d'un type et d'un gain maximal (ou inférieur) approuvé pour l'émetteur par Industrie Canada. Dans le but de réduire les risques de brouillage radioélectrique à l'intention des autres utilisateurs, il faut choisir le type d'antenne et son gain de sorte que la puissance isotrope rayonnée équivalente (p.i.r.e.) ne dépasse pas l'intensité nécessaire à l'établissement d'une communication satisfaisante.

Le présent émetteur radio a été approuvé par Industrie Canada pour fonctionner avec les types d'antenne énumérés dans le manuel d'usage et ayant un gain admissible maximal et l'impédance requise pour chaque type d'antenne. Les types d'antenne non inclus dans cette liste, ou dont le gain est supérieur au gain maximal indiqué, sont strictement interdits pour l'exploitation de l'émetteur.



## **【Important Notice for Users of this Product in Japan】**

### **This development kit is NOT certified as Confirming to Technical Regulations of Radio Law of Japan**

If you use this product in Japan, you are required by Radio Law of Japan to follow the instructions below with respect to this product:

1. Use this product in a shielded room or any other test facility as defined in the notification #173 issued by Ministry of Internal Affairs and Communications on March 28, 2006, based on Sub-section 1.1 of Article 6 of the Ministry's Rule for Enforcement of Radio Law of Japan,
2. Use this product only after you obtained the license of Test Radio Station as provided in Radio Law of Japan with respect to this product, or
3. Use of this product only after you obtained the Technical Regulations Conformity Certification as provided in Radio Law of Japan with respect to this product. Also, please do not transfer this product, unless you give the same notice above to the transferee. Please note that if you could not follow the instructions above, you will be subject to penalties of Radio Law of Japan.

**Texas Instruments Japan Limited**  
**(address) 24-1, Nishi-Shinjuku 6 chome, Shinjuku-ku, Tokyo, Japan**

<http://www.tij.co.jp>

#### **【ご使用にあたっての注】**

本開発キットは技術基準適合証明を受けておりません。

本製品のご使用に際しては、電波法遵守のため、以下のいずれかの措置を取っていただく必要がありますのでご注意ください。

1. 電波法施行規則第6条第1項第1号に基づく平成18年3月28日総務省告示第173号で定められた電波暗室等の試験設備でご使用いただく。
2. 実験局の免許を取得後ご使用いただく。
3. 技術基準適合証明を取得後ご使用いただく。

なお、本製品は、上記の「ご使用にあたっての注意」を譲渡先、移転先に通知しない限り、譲渡、移転できないものとします。

上記を遵守頂けない場合は、電波法の罰則が適用される可能性があることをご留意ください。

日本テキサス・インスツルメンツ株式会社  
東京都新宿区西新宿6丁目24番1号  
西新宿三井ビル

<http://www.tij.co.jp>

## EVALUATION BOARD/KIT/MODULE (EVM) WARNINGS, RESTRICTIONS AND DISCLAIMERS

**For Feasibility Evaluation Only, in Laboratory/Development Environments.** Unless otherwise indicated, this EVM is not a finished electrical equipment and not intended for consumer use. It is intended solely for use for preliminary feasibility evaluation in laboratory/development environments by technically qualified electronics experts who are familiar with the dangers and application risks associated with handling electrical mechanical components, systems and subsystems. It should not be used as all or part of a finished end product.

Your Sole Responsibility and Risk. You acknowledge, represent and agree that:

1. You have unique knowledge concerning Federal, State and local regulatory requirements (including but not limited to Food and Drug Administration regulations, if applicable) which relate to your products and which relate to your use (and/or that of your employees, affiliates, contractors or designees) of the EVM for evaluation, testing and other purposes.
2. You have full and exclusive responsibility to assure the safety and compliance of your products with all such laws and other applicable regulatory requirements, and also to assure the safety of any activities to be conducted by you and/or your employees, affiliates, contractors or designees, using the EVM. Further, you are responsible to assure that any interfaces (electronic and/or mechanical) between the EVM and any human body are designed with suitable isolation and means to safely limit accessible leakage currents to minimize the risk of electrical shock hazard.
3. You will employ reasonable safeguards to ensure that your use of the EVM will not result in any property damage, injury or death, even if the EVM should fail to perform as described or expected.
4. You will take care of proper disposal and recycling of the EVM's electronic components and packing materials.

**Certain Instructions.** It is important to operate this EVM within TI's recommended specifications and environmental considerations per the user guidelines. Exceeding the specified EVM ratings (including but not limited to input and output voltage, current, power, and environmental ranges) may cause property damage, personal injury or death. If there are questions concerning these ratings please contact a TI field representative prior to connecting interface electronics including input power and intended loads. Any loads applied outside of the specified output range may result in unintended and/or inaccurate operation and/or possible permanent damage to the EVM and/or interface electronics. Please consult the EVM User's Guide prior to connecting any load to the EVM output. If there is uncertainty as to the load specification, please contact a TI field representative. During normal operation, some circuit components may have case temperatures greater than 60°C as long as the input and output are maintained at a normal ambient operating temperature. These components include but are not limited to linear regulators, switching transistors, pass transistors, and current sense resistors which can be identified using the EVM schematic located in the EVM User's Guide. When placing measurement probes near these devices during normal operation, please be aware that these devices may be very warm to the touch. As with all electronic evaluation tools, only qualified personnel knowledgeable in electronic measurement and diagnostics normally found in development environments should use these EVMs.

**Agreement to Defend, Indemnify and Hold Harmless.** You agree to defend, indemnify and hold TI, its licensors and their representatives harmless from and against any and all claims, damages, losses, expenses, costs and liabilities (collectively, "Claims") arising out of or in connection with any use of the EVM that is not in accordance with the terms of the agreement. This obligation shall apply whether Claims arise under law of tort or contract or any other legal theory, and even if the EVM fails to perform as described or expected.

**Safety-Critical or Life-Critical Applications.** If you intend to evaluate the components for possible use in safety critical applications (such as life support) where a failure of the TI product would reasonably be expected to cause severe personal injury or death, such as devices which are classified as FDA Class III or similar classification, then you must specifically notify TI of such intent and enter into a separate Assurance and Indemnity Agreement.

Mailing Address: Texas Instruments, Post Office Box 655303, Dallas, Texas 75265  
Copyright © 2012, Texas Instruments Incorporated

## IMPORTANT NOTICE

Texas Instruments Incorporated and its subsidiaries (TI) reserve the right to make corrections, enhancements, improvements and other changes to its semiconductor products and services per JESD46, latest issue, and to discontinue any product or service per JESD48, latest issue. Buyers should obtain the latest relevant information before placing orders and should verify that such information is current and complete. All semiconductor products (also referred to herein as "components") are sold subject to TI's terms and conditions of sale supplied at the time of order acknowledgment.

TI warrants performance of its components to the specifications applicable at the time of sale, in accordance with the warranty in TI's terms and conditions of sale of semiconductor products. Testing and other quality control techniques are used to the extent TI deems necessary to support this warranty. Except where mandated by applicable law, testing of all parameters of each component is not necessarily performed.

TI assumes no liability for applications assistance or the design of Buyers' products. Buyers are responsible for their products and applications using TI components. To minimize the risks associated with Buyers' products and applications, Buyers should provide adequate design and operating safeguards.

TI does not warrant or represent that any license, either express or implied, is granted under any patent right, copyright, mask work right, or other intellectual property right relating to any combination, machine, or process in which TI components or services are used. Information published by TI regarding third-party products or services does not constitute a license to use such products or services or a warranty or endorsement thereof. Use of such information may require a license from a third party under the patents or other intellectual property of the third party, or a license from TI under the patents or other intellectual property of TI.

Reproduction of significant portions of TI information in TI data books or data sheets is permissible only if reproduction is without alteration and is accompanied by all associated warranties, conditions, limitations, and notices. TI is not responsible or liable for such altered documentation. Information of third parties may be subject to additional restrictions.

Resale of TI components or services with statements different from or beyond the parameters stated by TI for that component or service voids all express and any implied warranties for the associated TI component or service and is an unfair and deceptive business practice. TI is not responsible or liable for any such statements.

Buyer acknowledges and agrees that it is solely responsible for compliance with all legal, regulatory and safety-related requirements concerning its products, and any use of TI components in its applications, notwithstanding any applications-related information or support that may be provided by TI. Buyer represents and agrees that it has all the necessary expertise to create and implement safeguards which anticipate dangerous consequences of failures, monitor failures and their consequences, lessen the likelihood of failures that might cause harm and take appropriate remedial actions. Buyer will fully indemnify TI and its representatives against any damages arising out of the use of any TI components in safety-critical applications.

In some cases, TI components may be promoted specifically to facilitate safety-related applications. With such components, TI's goal is to help enable customers to design and create their own end-product solutions that meet applicable functional safety standards and requirements. Nonetheless, such components are subject to these terms.

No TI components are authorized for use in FDA Class III (or similar life-critical medical equipment) unless authorized officers of the parties have executed a special agreement specifically governing such use.

Only those TI components which TI has specifically designated as military grade or "enhanced plastic" are designed and intended for use in military/aerospace applications or environments. Buyer acknowledges and agrees that any military or aerospace use of TI components which have **not** been so designated is solely at the Buyer's risk, and that Buyer is solely responsible for compliance with all legal and regulatory requirements in connection with such use.

TI has specifically designated certain components which meet ISO/TS16949 requirements, mainly for automotive use. Components which have not been so designated are neither designed nor intended for automotive use; and TI will not be responsible for any failure of such components to meet such requirements.

### Products

Audio	<a href="http://www.ti.com/audio">www.ti.com/audio</a>
Amplifiers	<a href="http://amplifier.ti.com">amplifier.ti.com</a>
Data Converters	<a href="http://dataconverter.ti.com">dataconverter.ti.com</a>
DLP® Products	<a href="http://www.dlp.com">www.dlp.com</a>
DSP	<a href="http://dsp.ti.com">dsp.ti.com</a>
Clocks and Timers	<a href="http://www.ti.com/clocks">www.ti.com/clocks</a>
Interface	<a href="http://interface.ti.com">interface.ti.com</a>
Logic	<a href="http://logic.ti.com">logic.ti.com</a>
Power Mgmt	<a href="http://power.ti.com">power.ti.com</a>
Microcontrollers	<a href="http://microcontroller.ti.com">microcontroller.ti.com</a>
RFID	<a href="http://www.ti-rfid.com">www.ti-rfid.com</a>
OMAP Applications Processors	<a href="http://www.ti.com/omap">www.ti.com/omap</a>
Wireless Connectivity	<a href="http://www.ti.com/wirelessconnectivity">www.ti.com/wirelessconnectivity</a>

### Applications

Automotive and Transportation	<a href="http://www.ti.com/automotive">www.ti.com/automotive</a>
Communications and Telecom	<a href="http://www.ti.com/communications">www.ti.com/communications</a>
Computers and Peripherals	<a href="http://www.ti.com/computers">www.ti.com/computers</a>
Consumer Electronics	<a href="http://www.ti.com/consumer-apps">www.ti.com/consumer-apps</a>
Energy and Lighting	<a href="http://www.ti.com/energy">www.ti.com/energy</a>
Industrial	<a href="http://www.ti.com/industrial">www.ti.com/industrial</a>
Medical	<a href="http://www.ti.com/medical">www.ti.com/medical</a>
Security	<a href="http://www.ti.com/security">www.ti.com/security</a>
Space, Avionics and Defense	<a href="http://www.ti.com/space-avionics-defense">www.ti.com/space-avionics-defense</a>
Video and Imaging	<a href="http://www.ti.com/video">www.ti.com/video</a>

### TI E2E Community

[e2e.ti.com](http://e2e.ti.com)