

DESCRIPTION

The EV4026-J-00B Evaluation Board is designed to demonstrate the capabilities of MP4026. The MP4026 is a primary-side-control offline LED lighting controller which can achieve high power factor and accurate LED current for an isolated lighting application in a single stage converter. It works in boundary conduction mode for reducing the MOSFET and Diode switching losses.

The EV4026-J-00B is typically designed for driving an isolated 20W PAR38 LED bulb with 40V_{TYP}, 500mA LED load at universal input (90V-265VAC, 50/60Hz).

The EV4026-J-00B has high performances in efficiency, line/load regulation and meets IEC61547 surges, IEC61000-3-2 Class C harmonics and EN55015 conducted EMI. It has multi-protection function as over-voltage protection, short-circuit protection, primary-side OCP, etc.

ELECTRICAL SPECIFICATION

Parameter	Symbol	Value	Units
Input Voltage	V _{IN}	90 -265	VAC
Output Voltage	V _{OUT}	40	V
LED Current	I _{LED}	500	mA
Output Power	P _{OUT}	20	W
Efficiency (full load)	η	87~90	%
PF		>0.9	
THD		<20	%

FEATURES

- Small IC package: Thin SOT23-6
- Real current control without secondary-feedback circuit
- Good line/load regulation
- High power factor>0.9 over universal input voltage
- Boundary conduction mode improves efficiency
- Input UVLO
- Primary-side over current protection
- Over-voltage protection
- Short-circuit protection
- Over-temperature protection
- Fit inside PAR38 bulb enclosure

APPLICATIONS

- Solid State Lighting
- Industrial & Commercial Lighting
- Residential Lighting

All MPS parts are lead-free and adhere to the RoHS directive. For MPS green status, please visit MPS website under Quality Assurance. "MPS" and "The Future of Analog IC Technology", are Registered Trademarks of Monolithic Power Systems, Inc.



Warning: Although this board is designed to satisfy safety requirements, the engineering prototype has not been agency approved. Therefore, all testing should be performed using an isolation transformer to provide the AC input to the prototype board.

EV4026-J-00B EVALUATION BOARD

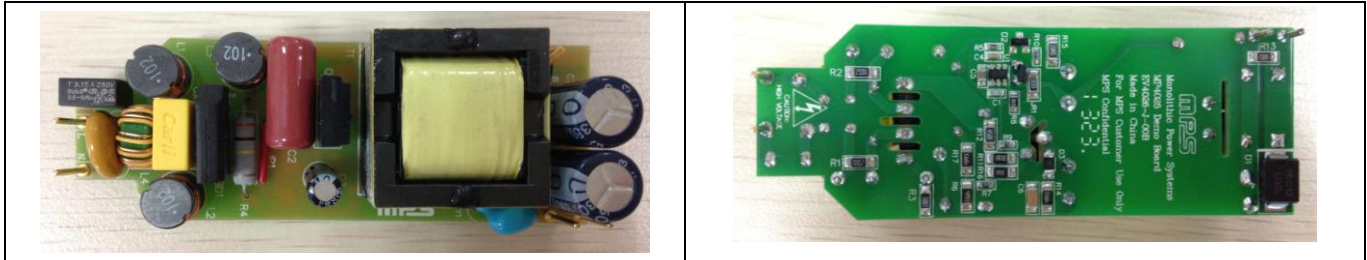

(L x W x H) 83.5mm x 30.0mm x 23mm

Board Number	MPS IC Number
EV4026-J-00B	MP4026GJ-Z

EVALUATION BOARD SCHEMATIC

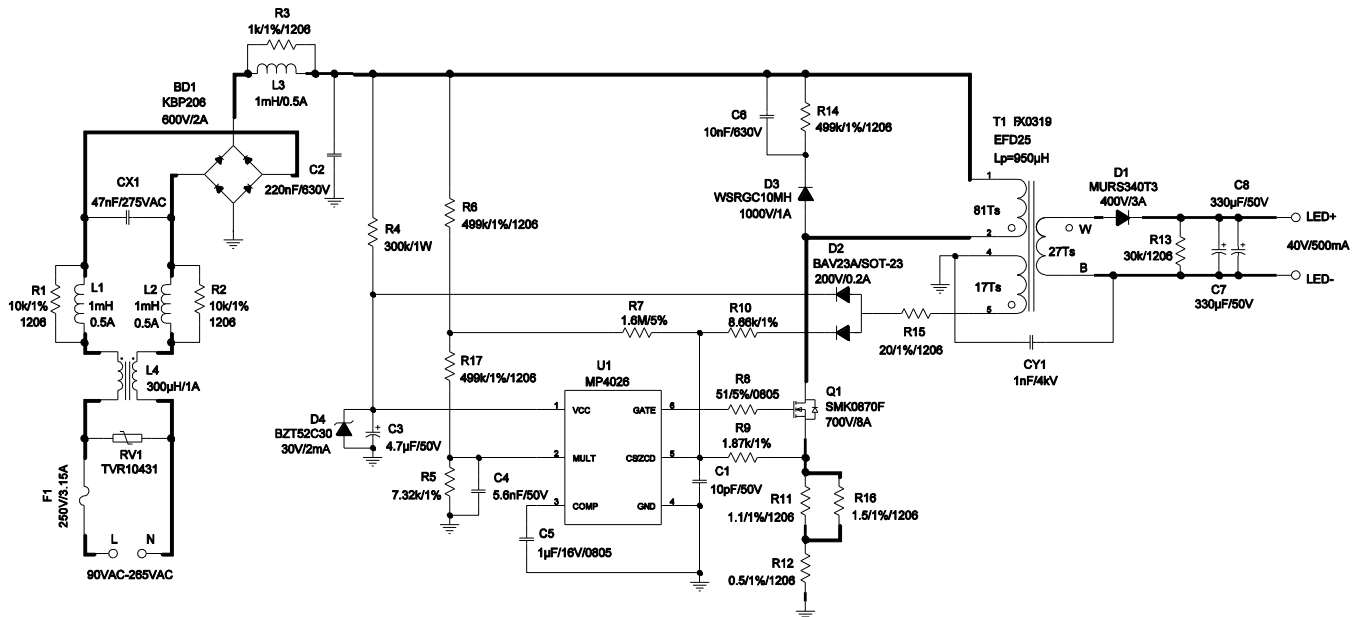

Figure 1 - Schematic

PCB LAYOUT (DOUBLE-SIDED)

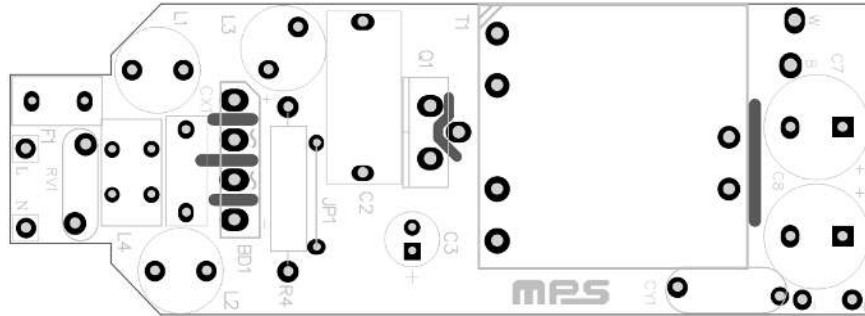

Figure 2 - Top Layer

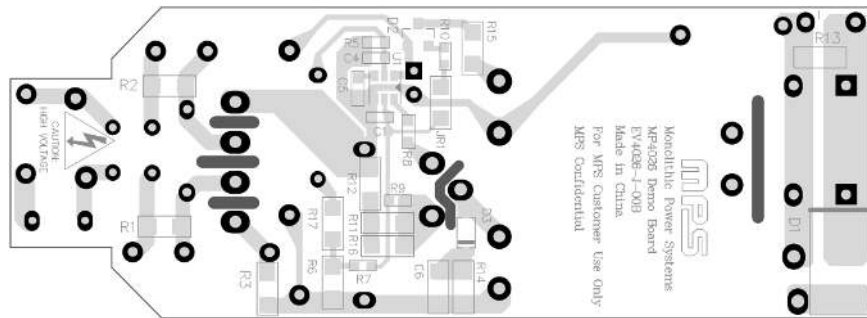

Figure 3 - Bottom Layer

CIRCUIT DESCRIPTION

The EV4026-J-00B is configured in a single-stage FLYBACK topology, it uses primary-side-control which can mostly simplify the schematic and get a cost effective BOM. It can also achieve high power factor and accurate LED current.

F1, RV1, CX1, L1, L2, L3, L4, C2 and BD1 compose the input stage. F1 fuses the AC input to protect for the component failure or some excessive short events. RV1 is used to absorb the high ring voltage of surge test, L1, L2, CX1, L3, L4, R1, R2, R3 and C2 associated with CY1 form the EMI filter which can meet the requirement for universal input. The diode rectifier BD1 rectifies the input line voltage. Small bulk CBB capacitor C2 is used for a low impedance path for the primary switching current, to maintain high power factor, the capacitance of C2 should be selected with low value.

R5, R6, R17, C4 provide sine wave reference for the primary peak current to get an active PFC function. The divided voltage should be lower than the max voltage rating of MULT pin.

R4, C3, D2, R15 are used to supply the power for MP4026. A 4.7 μ F electrolytic capacitor C3 is selected to maintain the supply voltage. At start-up, C3 is first charged up by the starter resistor R4 from the line voltage, when the VCC voltage passes the turn on threshold the IC starts to work and the gate begins to switch, then the VCC power supply is taken over by the auxiliary winding through R15, D2.

R9, R10, D2, C1 are used to detect the auxiliary winding to get the transformer magnetizing current zero crossing signal for realizing the boundary conduction operation, and also monitor the output OVP condition. The OVP voltage is set by the divider ratio of R9, R10. D2 is used to block the negative plateau voltage of auxiliary winding when MOSFET is turn on. C1 is used to decouple the high frequency noise influence on CS/ZCD pin.

R11, R12 are primary sensing resistors for primary side current control. The value of R11, R12 set the output LED current. R7 is used to form a feedforward from input line voltage to optimize the line regulation. C6, R14, D3 are used to damp the leakage inductance energy so the drain voltage can be suppressed at a safe level.

Diode D1 rectifies the secondary winding voltage and the capacitor C7, C8 are the output filter. The resistor R13 is placed as pre-load to limit the output voltage rise too high in open load condition.

EV4026-J-00B BILL OF MATERIALS

Qty	Ref	Value	Description	Package	Manufacturer	Manufacturer_P/N
1	BD1	KBP206	BRIDGE, 600V, 2A	DIP	Bangdayuan	KBP206
1	C1	10pF	Ceramic Capacitor, 50V, COG	0603	Murata	GRM1885C1H100JAO1
1	C2	220nF/630V	Capacitor;630V; CBB	DIP	Panasonic	ECQE6224KF
1	C3	4.7μF/50V	Electrolytic Capacitor; 50V;105°C	DIP	Jianghai	CD287-50V4.7
1	C4	5.6nF/50V	Ceramic Capacitor; 50V;X7R	0603	muRata	GRM188R71H562KA01D
1	C5	1μF/16V	Ceramic Capacitor, 16V, X7R	0805	Murata	GRM21BR71C105KA01
1	C6	10nF/630V	Ceramic Capacitor, 630V, X7R	1206	TDK	C3216X7R2J103K
2	C7, C8	330μF/50V	Electrolytic Capacitor; 50V;105°C	DIP	Jianghai	CD263-50V330(10*16)
1	CX1	47nF/275VAC	X2 Capacitor, 275V	DIP	Carli	PX473K3IB29L270D9R
1	CY1	1nF/4kV	Y1 Capacitor, 4kV	DIP	Hongke	JNK09E102MY02N
1	D1	MURS340T3	Diode, 3A, 400V	SMC	ON Semi	MURS340T3
1	D2	BAV23A	Diode, 0.2A, 200V	SOT-23	Jianfu	BAV23A
1	D3	WSRGC10MH	Diode, 1kV, 1A	1206	ZOWIE	WSRGC10MH
1	D4	BZT52C30	Zener Diode, 30V, 2mA	SOD-123	Diodes	BZT52C30
1	F1	250V/3.15A	Fuse, 250V, 3.15A	DIP	COOPER	SS-5-3.15A
1	JP1	0Ω	Wire			
1	JR1	0Ω	Film Resistor;1%	1206	Yageo	RC1206FR-070RL
3	L1, L2, L3	1mH	Inductor, 1mH, 0.5A	DIP	Würth	768772102
1	L4	300μH	Common Choke, 300μH, 1A	DIP	EMEI	TP4U300-00
1	Q1	SMK0870F	N-Channel MOSFET, 700V, 8A	TO-220F	AUK	SMK0870F
2	R1, R2	10kΩ	Film Resistor;1%	1206	Yageo	RC1206FR-0710KL
1	R3	1kΩ	Film Resistor;1%	1206	Yageo	RC1206FR-071KL
1	R4	300kΩ	Film Resistor;5%,1W	DIP	Any	
1	R5	7.32kΩ	Film Resistor;1%	0603	Yageo	RC0603FR-077K32L
3	R6, R14, R17	499kΩ	Film Resistor;1%	1206	Yageo	RC1206FR-07499KL
1	R7	1.6MΩ	Film Resistor;5%	0603	Yageo	RC-03L165JT
1	R8	51Ω	Film Resistor;5%	0805	Yageo	RC0805JR-0751RL
1	R9	1.87kΩ	Film Resistor;1%	0603	Yageo	RC0603FR-071k87L
1	R10	8.66kΩ	Film Resistor;1%	0603	Yageo	RC0603FR-078k66L

EV4026-J-00B BILL OF MATERIALS (continued)

Qty	Ref	Value	Description	Package	Manufacturer	Manufacturer_P/N
1	R11	1.1Ω	Film Resistor;1%	1206	Yageo	RC1206FR-071R1L
1	R12	500mΩ	Film Resistor;1%	1206	Yageo	RC1206FR-070R5L
1	R13	30kΩ	Film Resistor;1%	1206	Yageo	RC1206FR-0730KL
1	R15	20Ω	Film Resistor;1%	1206	Yageo	RC1206FR-0720RL
1	R16	1.5Ω	Film Resistor;1%	1206	Yageo	RC1206FR-071R5L
1	RV1	TVR10431KSY	430V, 2500A	DIP	TKS	TVR10431KSY
1	T1	FX0319	EFD25;LP=950μH; NP:Ns:NAUX:NShielding =81:27:17:60	EFD25	EMEI	FX0319
1	U1	MP4026	Offline LED Lighting Controller	FCTSOT-6	MPS	MP4026GJ-Z

TRANSFORMER SPECIFICATION

Electrical Diagram

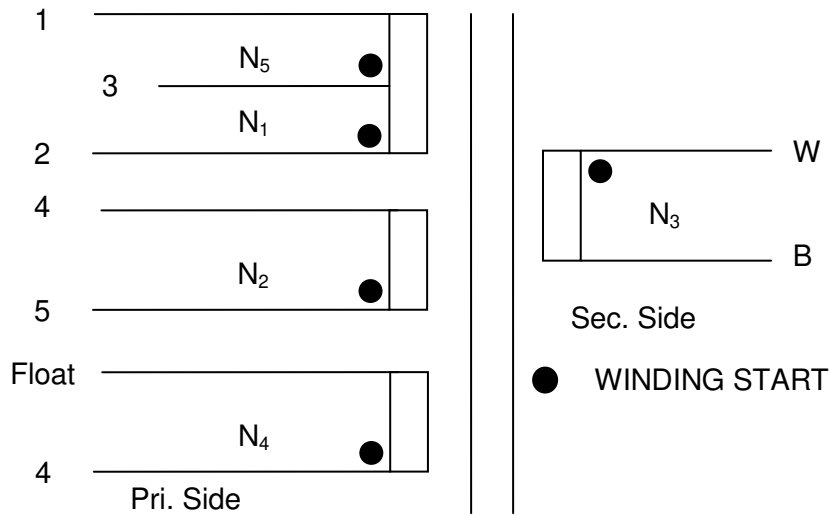

Figure 4 – Transformer Electrical Diagram

Notes: 1. N₄ is shielding winding, float Float pin in the winding.

Winding Diagram

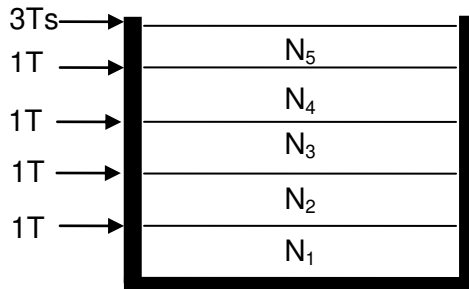

Figure 5 – Winding Diagram

Winding Order

Winding No.	Tape Layer Number	Start & End	Magnet WireΦ(mm)	Turns
N ₁	1	2→3	0.25*2	57
N ₂	1	5→4	0.18*1	17
N ₃	1	W→B	0.35*2 (T.I.W)	27
N ₄	1	4→Float	0.15*1	60
N ₅	3	3→1	0.25*2	24

Electrical Specifications

Electrical Strength	1 second, 50Hz, from Pins 1, 2, 4, 5 to W, B	2500VAC
Primary Inductance	Pins 1- 2, all other windings open, measured at 40kHz, 0.25 VRMS	950 μ H \pm 8%
Primary Leakage Inductance	Pins 1-2 with pins 4, 5 W, B shorted, measured at 100kHz, 0.1 VRMS	20 μ H \pm 10%

Materials

Item	Description
1	Core: EFD25, UI=2300, AL=179.0nH/N ² \pm 3% GAPPED, ACME P4
2	Bobbin: EFD25, 5+5PIN SECT T-H T375J UL94V-0
3	Wire: Φ 0.25mm, Φ 0.18mm, Φ 0.15mm, UEWF, CLASS B
4	Triple Insulation Wire: Φ 0.35mm,TRW(B)
5	Tape: 17.0mm(W) \times 0.06mm(TH), Yellow
6	Tube:#22 Black
7	Varnish: BC-346A
8	Epoxy: E-500
9	Solder Bar: SN99.5/Cu0.5

EVB TEST RESULTS

Performance Data

f (Hz)	V_{IN} (VAC)	P_{IN} (W)	V_{OUT} (V)	I_{12LEDs} (mA)	P_{OUT} (W)	η (%)	PF	I_{11LEDs} (mA)	I_{10LEDs} (mA)	I_{9LEDs} (mA)	I_{8LEDs} (mA)	I_{7LEDs} (mA)	I_{6LEDs} (mA)
60	90	22.08	39.40	489.0	19.27	87.3	0.997	493	496	499	502	506	509
	100	21.92	39.40	490.0	19.31	88.1	0.997	494	497	500	502	506	510
	110	21.82	39.40	491.0	19.35	88.7	0.996	494	497	500	503	506	510
	120	21.74	39.40	492.0	19.38	89.2	0.995	494	497	500	503	506	509
	135	21.66	39.40	492.0	19.38	89.5	0.993	494	498	500	503	506	509
	150	21.63	39.40	492.0	19.38	89.6	0.989	494	498	500	504	506	509
	170	21.61	39.40	492.0	19.38	89.7	0.983	494	498	500	504	506	508
50	185	21.64	39.40	492.0	19.38	89.6	0.978	495	498	501	504	507	508
	200	21.68	39.40	492.0	19.38	89.4	0.972	495	498	501	504	507	508
	220	21.74	39.40	492.0	19.38	89.2	0.962	495	498	501	504	507	508
	230	21.77	39.40	492.0	19.38	89.0	0.956	495	498	501	505	508	508
	240	21.81	39.40	492.0	19.38	88.9	0.950	495	498	501	505	508	508
	250	21.86	39.40	492.0	19.38	88.7	0.943	495	498	502	505	508	508
	265	21.95	39.40	493.0	19.42	88.5	0.933	495	499	502	506	508	508

Harmonic Data

The design passes EN6100-3-2 Class C (active input power $\leq 25W$) requirement.

V_{IN} (VAC/Hz)	P_{IN} (W)	I_{IN} (mA)	THD (%)	V_{IN} (VAC/Hz)	P_{IN} (W)	I_{IN} (mA)	THD (%)
115/60	20.52	179.61	9.36	230/50	20.42	93.44	16.65
Harmonic Order	Limit (mA)	Content (mA)	Test Result (Pass/Fail)	Harmonic Order	Limit (mA)	Content (mA)	Test Result (Pass/Fail)
3	139.54	16.21	Pass	3	69.43	14.83	Pass
5	77.98	2.47	Pass	5	38.80	3.68	Pass
7	41.04	1.07	Pass	7	20.42	1.65	Pass
9	20.52	1.40	Pass	9	10.21	1.29	Pass
11	14.36	1.39	Pass	11	7.15	1.08	Pass
13	12.15	1.33	Pass	13	6.05	1.09	Pass
15	10.53	1.20	Pass	15	5.24	0.89	Pass
17	9.29	1.07	Pass	17	4.62	0.85	Pass
19	8.32	1.03	Pass	19	4.14	0.79	Pass
21	7.52	0.87	Pass	21	3.74	0.76	Pass
23	6.87	0.80	Pass	23	3.42	0.64	Pass
25	6.32	0.69	Pass	25	3.14	0.54	Pass
27	5.85	0.59	Pass	27	2.91	0.55	Pass
29	5.45	0.47	Pass	29	2.71	0.47	Pass
31	5.10	0.37	Pass	31	2.54	0.40	Pass
33	4.79	0.36	Pass	33	2.38	0.33	Pass
35	4.51	0.29	Pass	35	2.25	0.31	Pass
37	4.27	0.25	Pass	37	2.12	0.24	Pass
39	4.05	0.16	Pass	39	2.02	0.26	Pass

Electric Strength Test

Primary circuit to secondary circuit electric strength testing was completed according to IEC61347-1 and IEC61347-2-13.

Input and output was shorted respectively. 3750VAC/50Hz sine wave applied between input and output for 1min, and operation was verified.

Surge Test

Line to Line 500V and Line to Power Earth 1kV surge testing was completed according to IEC61547. Input voltage was set at 230VAC/50Hz. Output was loaded at full load and operation was verified following each surge event.

Surge Level (V)	Input Voltage (VAC)	Injection Location	Injection Phase (°)	Test Result (Pass/Fail)
500	230	L to N	90	Pass
-500	230	L to N	270	Pass
1000	230	L to PE	90	Pass
-1000	230	L to PE	270	Pass
1000	230	N to PE	90	Pass
-1000	230	N to PE	270	Pass

EVB TEST RESULTS

Performance waveforms are tested on the evaluation board.
 12 LEDs in series, $I_{LED}=500mA$, $V_{OUT}=40V$, $L_P=950\mu H$, $N_P:N_S:N_{AUX}=81:27:17$.

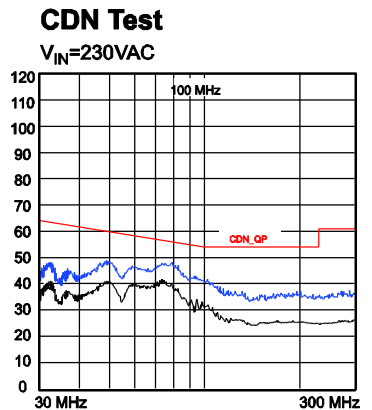
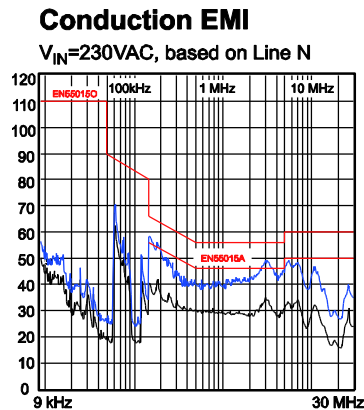
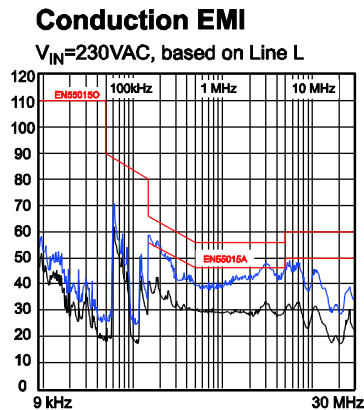
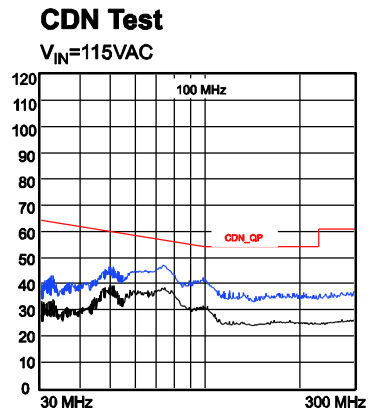
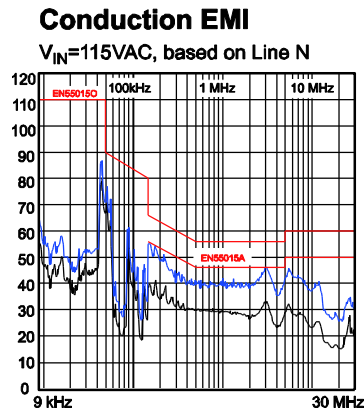
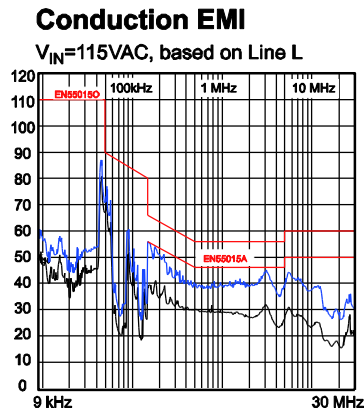
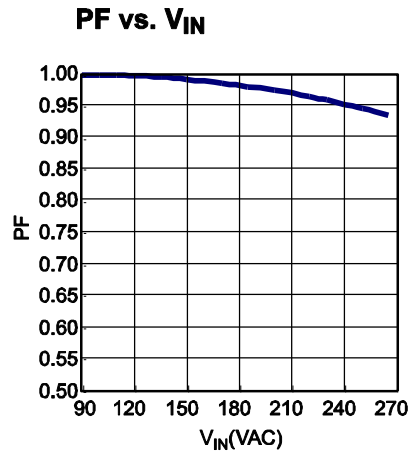
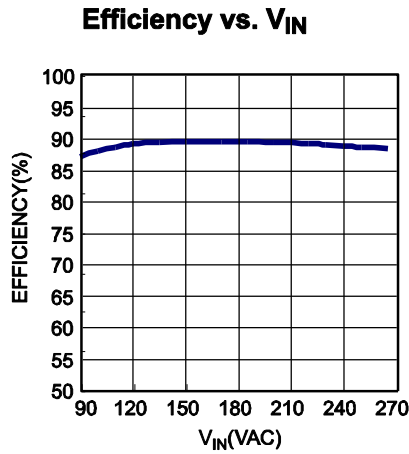
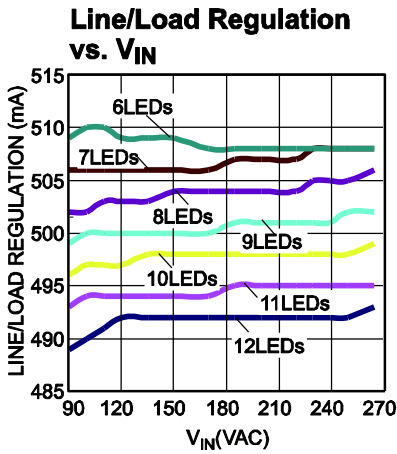

EVB TEST RESULTS *(continued)*

Performance waveforms are tested on the evaluation board.

12 LEDs in series, $V_{IN}=120VAC/60Hz$, $I_{LED}=500mA$, $V_{OUT}=40V$, $L_P=950\mu H$, $N_p:N_s:N_{AUX} = 81:27:17$.

Steady State

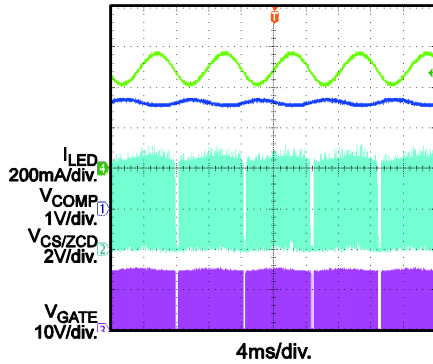

Steady State

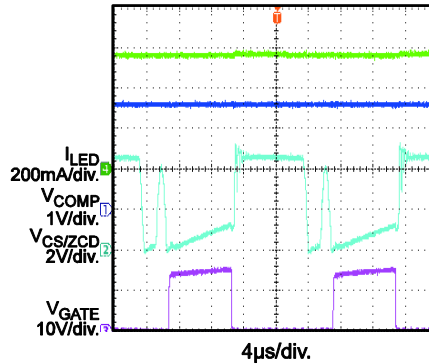

Steady State

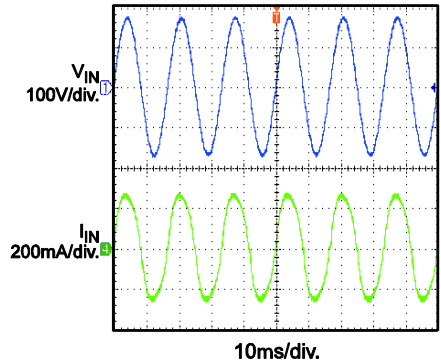

V_{IN} Start-Up

$T_{START_UP} = 392ms$

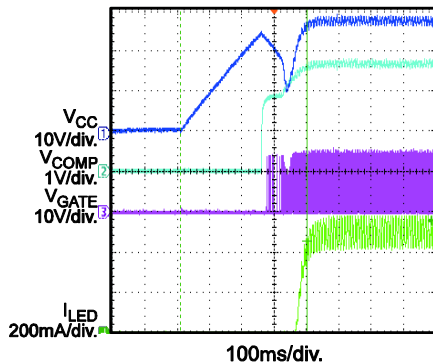

V_{IN} Shut-Down

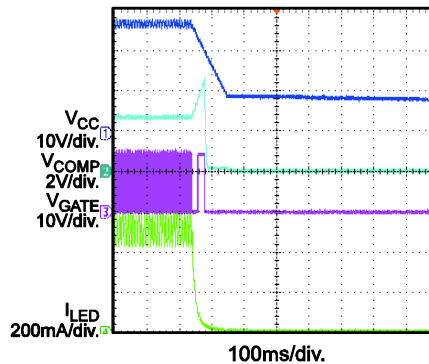

OCP

Short Primary Inductor @ Working then Recovery

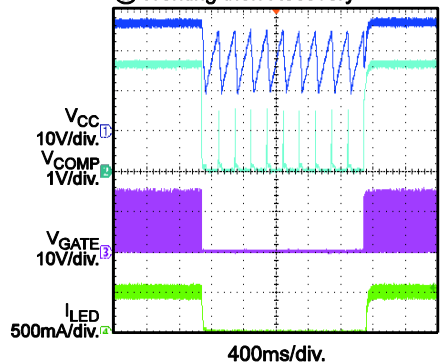

SCP

Short LEDs @ Working then Recovery

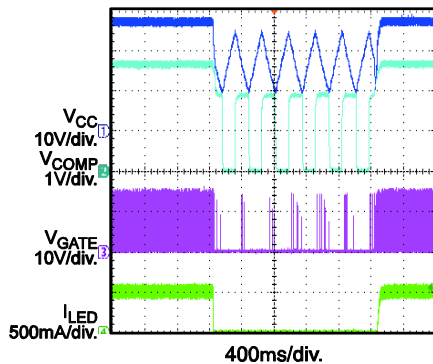

OVP

Open LEDs @ Working then Recovery

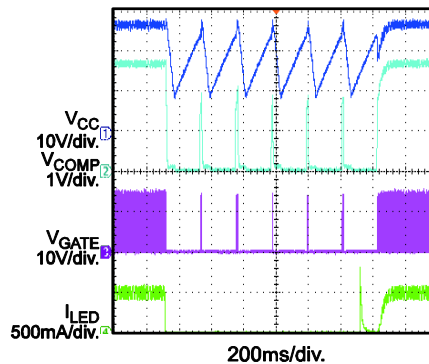

OVP

Open LEDs @ Working then Recovery

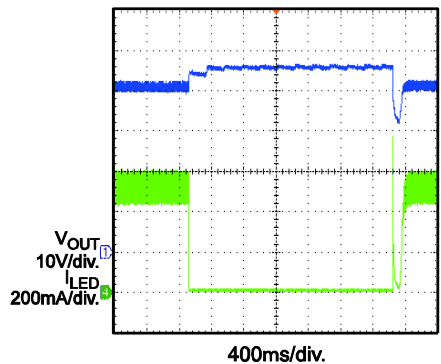

EVB TEST RESULTS *(continued)*

Performance waveforms are tested on the evaluation board.

12 LEDs in series, $V_{IN}=230VAC/50Hz$, $I_{LED}=500mA$, $V_{OUT}=40V$, $L_P=950\mu H$, $N_p:N_s:N_{AUX} = 81:27:17$.

Steady State

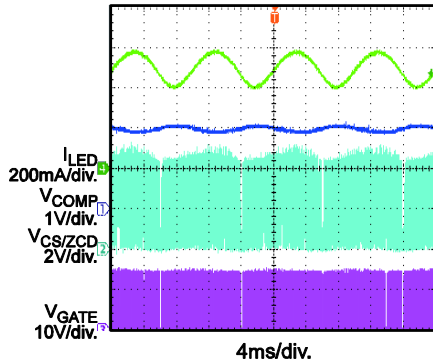

Steady State

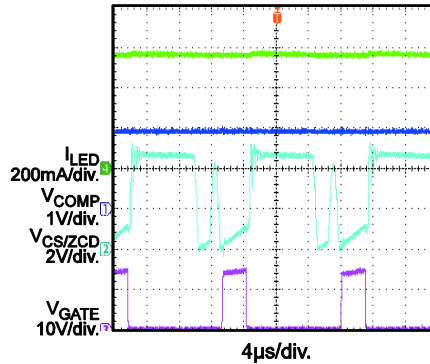

Steady State

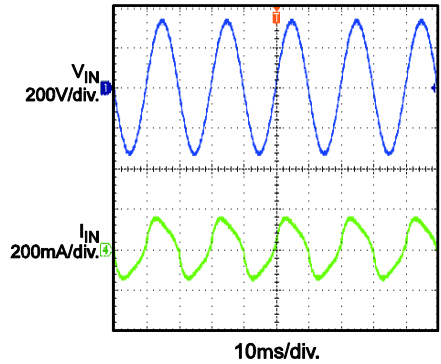

V_{IN} Start-Up
 $T_{START_UP} = 310ms$

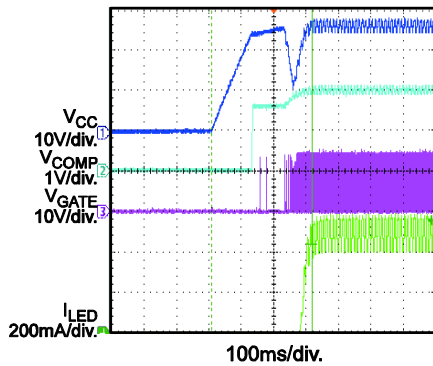

V_{IN} Shut-Down

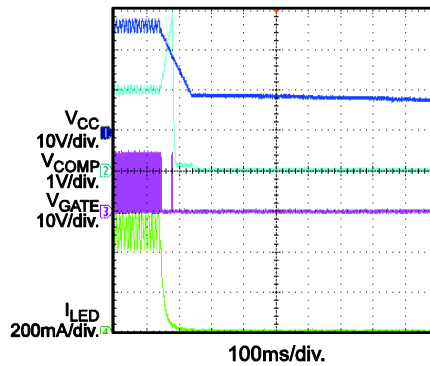

OCP
Short Primary Inductor
@ Working then Recovery

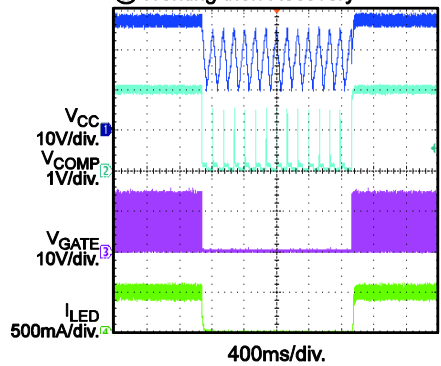

SCP
Short LEDs @ Working then Recovery

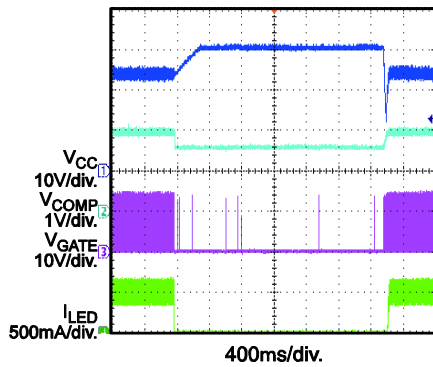

OVP
Open LEDs @ Working then Recovery

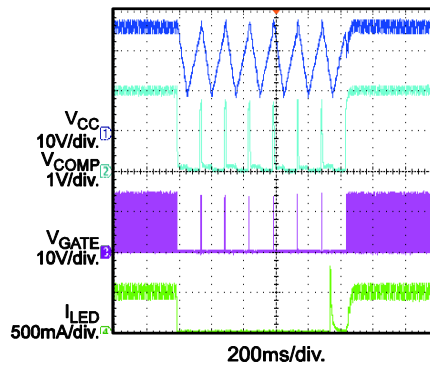

OVP
Open LEDs @ Working then Recovery

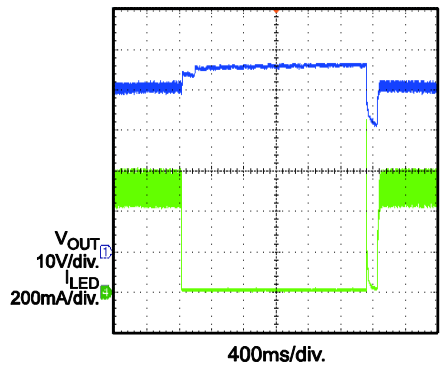

QUICK START GUIDE

1. Preset AC Power Supply to $90\text{VAC} \leq V_{\text{IN}} \leq 265\text{VAC}$.
2. Turn Power Supply off.
3. Connect the LED string between “LED+” (anode of LED string) and “LED-” (cathode of LED string).
4. Connect Power Supply terminals to AC V_{IN} terminals as shown on the board.
5. Turn AC Power Supply on after making connections.

NOTICE: The information in this document is subject to change without notice. Please contact MPS for current specifications. Users should warrant and guarantee that third party Intellectual Property rights are not infringed upon when integrating MPS products into any application. MPS will not assume any legal responsibility for any said applications.