



# QUAD 2-PORT REGISTER

The MC54/74F399 is the logical equivalent of a quad 2-input multiplexer feeding into four edge-triggered flip flops. A common Select input determines which of the two 4-bit words is accepted. The selected data enters the flip-flops on the rising edge of the clock. The MC54/74F399 is the 16-pin version of the MC54/74F398, with only the Q outputs of the flip-flops available.

- Select Inputs from Two Data Sources
- Fully Positive Edge-Triggered Operation

CONNECTION DIAGRAM (TOP VIEW)

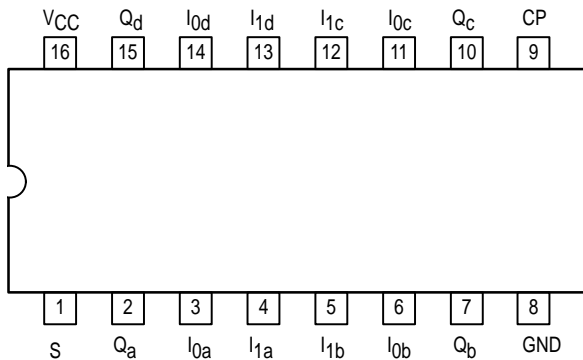

LOGIC DIAGRAM

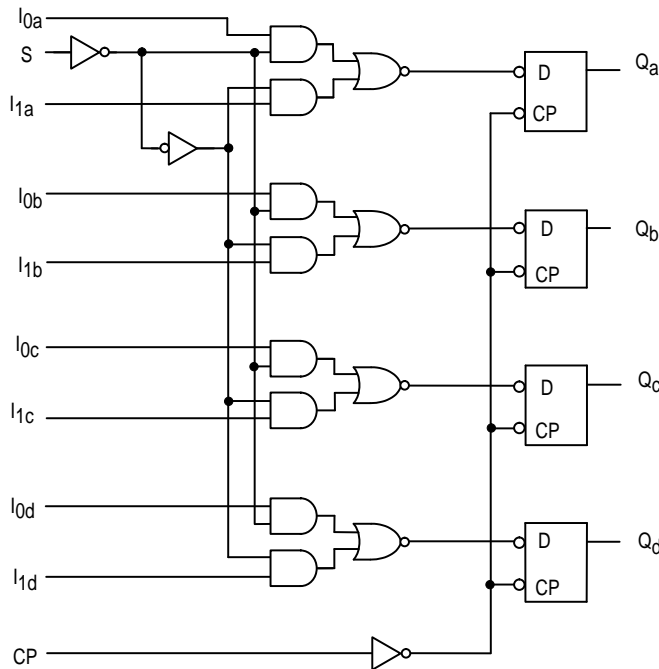

NOTE:  
This diagram is provided only for the understanding of logic operations and should not be used to estimate propagation delays.

## MC54/74F399

QUAD 2-PORT REGISTER  
FAST™ SCHOTTKY TTL

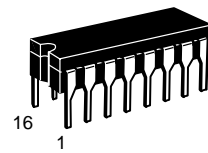

J SUFFIX  
CERAMIC  
CASE 620-09

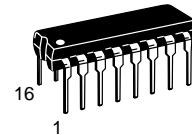

N SUFFIX  
PLASTIC  
CASE 648-08

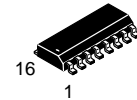

D SUFFIX  
SOIC  
CASE 751B-03

ORDERING INFORMATION

MC54FXXXJ	Ceramic
MC74FXXXN	Plastic
MC74FXXXD	SOIC

LOGIC SYMBOL

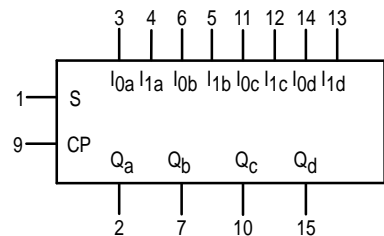

VCC = PIN 16  
GND = PIN 8

LIFETIME BUY

LAST SHIP 30/09/99  
LAST ORDER 31/03/99

# MC54/74F399

## FUNCTIONAL DESCRIPTION

The MC54/74F398 is a high-speed quad 2-port register. It will select four bits of data from either of two sources (Ports) under control of a common Select input (S). The selected data is transferred to a 4-bit output register synchronous with the LOW-to-HIGH transition of the Clock input (CP). The 4-bit D-

type output register is fully edge-triggered. The Data inputs ( $I_{0x}$ ,  $I_{1x}$ ) and Select input (S) must be stable only a setup time prior to and hold time after the LOW-to-HIGH transition of the Clock input for predictable operation.

### FUNCTION TABLE

Inputs			Output
S	$I_0$	$I_1$	Q
l	l	X	L
l	h	X	H
h	X	l	L
h	X	h	H

H = HIGH Voltage Level

L = LOW Voltage Level

h = HIGH Voltage Level one setup time prior to the LOW-to-HIGH clock transition

l = LOW Voltage Level one setup time prior to the LOW-to-HIGH clock transition

X = Don't Care

### GUARANTEED OPERATING RANGES

Symbol	Parameter		Min	Typ	Max	Unit
$V_{CC}$	Supply Voltage	54, 74	4.5	5.0	5.5	V
$T_A$	Operating Ambient Temperature Range	54	-55	25	125	°C
		74	0	25	70	
$I_{OH}$	Output Current — High	54, 74			-1.0	mA
$I_{OL}$	Output Current — Low	54, 74			20	mA

### DC CHARACTERISTICS OVER OPERATING TEMPERATURE RANGE (unless otherwise specified)

Symbol	Parameter	Limits			Unit	Test Conditions	
		Min	Typ	Max			
$V_{IH}$	Input HIGH Voltage	2.0			V	Guaranteed Input HIGH Voltage	
$V_{IL}$	Input LOW Voltage			0.8	V	Guaranteed Input LOW Voltage	
$V_{IK}$	Input Clamp Diode Voltage			-1.2	V	$I_{IN} = -18$ mA	$V_{CC} = \text{MIN}$
$V_{OH}$	Output HIGH Voltage	54, 74	2.5	3.4	V	$I_{OH} = -1.0$ mA	$V_{CC} = 4.5$ V
		74	2.7	3.4	V	$I_{OH} = -1.0$ mA	$V_{CC} = 4.75$ V
$V_{OL}$	Output LOW Voltage		0.35	0.5	V	$I_{OL} = 20$ mA	$V_{CC} = \text{MIN}$
$I_{IH}$	Input HIGH Current			20	μA	$V_{IN} = 2.7$ V	$V_{CC} = \text{MAX}$
				100	μA	$V_{IN} = 7.0$ V	
$I_{IL}$	Input LOW Current			-0.6	mA	$V_{IN} = 0.5$ V	$V_{CC} = \text{MAX}$
$I_{OS}$	Output Short Circuit Current (Note 2)	-60		-150	mA	$V_{OUT} = 0$ V	$V_{CC} = \text{MAX}$
$I_{CC}$	Power Supply Current		22	34	mA	$V_{CC} = \text{MAX}$	$V_{IN} = \text{GND}$ $CP = \sqrt{\quad}$

#### NOTES:

- For conditions shown as MIN or MAX, use the appropriate value specified under guaranteed operating ranges.
- Not more than one output should be shorted at a time, nor for more than 1 second.

# MC54/74F399

## AC CHARACTERISTICS

Symbol	Parameter	54/74F			54F		74F		Unit
		T <sub>A</sub> = +25°C V <sub>CC</sub> = +5.0V C <sub>L</sub> = 50 pF			T <sub>A</sub> = -55°C to +125°C V <sub>CC</sub> = 5.0 V ± 10% C <sub>L</sub> = 50 pF		T <sub>A</sub> = 0°C to 70°C V <sub>CC</sub> = 5.0 V ± 10% C <sub>L</sub> = 50 pF		
		Min	Typ	Max	Min	Max	Min	Max	
f <sub>max</sub>	Maximum Clock Frequency	100	140		80		100		MHz
t <sub>PLH</sub>	Propagation Delay	3.0	5.7	7.5	3.0	9.5	3.0	8.5	ns
t <sub>PHL</sub>	CP to Q	3.0	6.8	9.5	3.0	11.5	3.0	10.0	

## AC OPERATING REQUIREMENTS

Symbol	Parameter	54/74F			54F		74F		Unit
		T <sub>A</sub> = +25°C V <sub>CC</sub> = +5.0V			T <sub>A</sub> = -55°C to +125°C V <sub>CC</sub> = 5.0 V ± 10%		T <sub>A</sub> = 0°C to 70°C V <sub>CC</sub> = 5.0 V ± 10%		
		Min	Typ	Max	Min	Max	Min	Max	
t <sub>S</sub> (H)	Setup Time, HIGH or LOW	3.0			4.5		3.0		ns
t <sub>S</sub> (L)	I <sub>n</sub> to CP	3.0			4.5		3.0		
t <sub>H</sub> (H)	Hold Time, HIGH or LOW	1.0			1.5		1.0		ns
t <sub>H</sub> (L)	I <sub>n</sub> to CP	1.0			1.5		1.0		
t <sub>S</sub> (H)	Setup Time, HIGH or LOW	7.5			9.5		8.5		ns
t <sub>S</sub> (L)	S to CP	7.5			9.5		8.5		
t <sub>H</sub> (H)	Hold Time, HIGH or LOW	0			0		0		ns
t <sub>H</sub> (L)	S to CP	0			0		0		
t <sub>w</sub> (H)	CP Pulse Width	4.0			4.0		4.0		ns
t <sub>w</sub> (L)	HIGH or LOW	5.0			7.0		5.0		

LIFETIME BUY

LAST SHIP 30/09/99  
LAST ORDER 31/03/99

LIFETIME BUY

LAST SHIP 30/09/99  
LAST ORDER 31/03/99

Mfax is a trademark of Motorola, Inc.

Motorola reserves the right to make changes without further notice to any products herein. Motorola makes no warranty, representation or guarantee regarding the suitability of its products for any particular purpose, nor does Motorola assume any liability arising out of the application or use of any product or circuit, and specifically disclaims any and all liability, including without limitation consequential or incidental damages. "Typical" parameters which may be provided in Motorola data sheets and/or specifications can and do vary in different applications and actual performance may vary over time. All operating parameters, including "Typicals" must be validated for each customer application by customer's technical experts. Motorola does not convey any license under its patent rights nor the rights of others. Motorola products are not designed, intended, or authorized for use as components in systems intended for surgical implant into the body, or other applications intended to support or sustain life, or for any other application in which the failure of the Motorola product could create a situation where personal injury or death may occur. Should Buyer purchase or use Motorola products for any such unintended or unauthorized application, Buyer shall indemnify and hold Motorola and its officers, employees, subsidiaries, affiliates, and distributors harmless against all claims, costs, damages, and expenses, and reasonable attorney fees arising out of, directly or indirectly, any claim of personal injury or death associated with such unintended or unauthorized use, even if such claim alleges that Motorola was negligent regarding the design or manufacture of the part. Motorola and  are registered trademarks of Motorola, Inc. Motorola, Inc. is an Equal Opportunity/Affirmative Action Employer.

**How to reach us:**

**USA/EUROPE/Locations Not Listed:** Motorola Literature Distribution; P.O. Box 5405, Denver, Colorado 80217.  
1-303-675-2140 or 1-800-441-2447

**JAPAN:** Motorola Japan Ltd.; SPS, Technical Information Center, 3-20-1, Minami-Azabu, Minato-ku, Tokyo 106-8573 Japan.  
81-3-3440-3569

**ASIA/PACIFIC:** Motorola Semiconductors H.K. Ltd.; Silicon Harbour Centre, 2 Dai King Street, Tai Po Industrial Estate, Tai Po, N.T., Hong Kong. 852-26668334

**Customer Focus Center: 1-800-521-6274**

**Mfax™:** RMFAX0@email.sps.mot.com – TOUCHTONE 1-602-244-6609  
Motorola Fax Back System – US & Canada ONLY 1-800-774-1848  
– <http://sps.motorola.com/mfax/>

**HOME PAGE:** <http://motorola.com/sps/>



**MOTOROLA**

