



The Future of Analog IC Technology®

MP6517

Programmable Single-Phase, BLDC, Motor Driver with Integrated Hall Sensor

DESCRIPTION

The MP6517 is a single-phase, brushless, DC motor driver with integrated power MOSFETs and a Hall effect sensor. The MP6517 drives single-phase, brushless, DC fan motors with up to 1.2A of output current limit. The IC has a 3.3V to 18V input voltage range and input line reverse voltage protection to save the external diode on the supply line.

The MP6517 controls the rotational speed through the PWM signal on the PWM pin. The MP6517 has a rotational speed detector feature and rotor lock fault indication on FG/RD with an open-drain collector output. The output speed versus the input duty curve can be programmed easily for flexible use. To reduce fan driver audible noise and power loss, the MP6517 features a soft on/off phase transition and automatic phase-lock function of the motor winding BEMF and current.

Full protection features include input over-voltage protection (OVP), under-voltage lockout (UVLO), rotor deadlocked protection, thermal shutdown, and input reverse protection.

The MP6517 requires a minimal number of external components to save solution cost. The MP6517 is available in a TSOT23-6 package.

FEATURES

- Embedded Hall Sensor with High Sensitivity
- Wide 3.3V to 18V Operating Input Range
- Up to 1.2A Programmable Current Limit
- Integrated Power MOSFETs: Total 850mΩ (HS + LS)
- Programmable Speed Curve
- Automatic Phase Lock Detection of Winding BEMF and Current Zero-Crossing
- Soft On/Off Phase Transition
- Rotational Speed Indicator FG Signal
- 12kHz to 48kHz PWM Input Frequency Range
- Fixed 26kHz Output Switching Frequency
- Input Line Reverse Voltage Protection (RVP)
- Rotor Deadlocked Protection and Automatic Recovery
- Thermal Protection and Automatic Recovery
- Built-In Input OVP, UVLO, and Automatic Recovery
- Available in a TSOT23-6 Package

APPLICATIONS

- CPU Fan for Personal Computers or Servers
- Brushless DC Motors

All MPS parts are lead-free, halogen-free, and adhere to the RoHS directive. For MPS green status, please visit the MPS website under Quality Assurance. "MPS" and "The Future of Analog IC Technology" are registered trademarks of Monolithic Power Systems, Inc.

TYPICAL APPLICATION

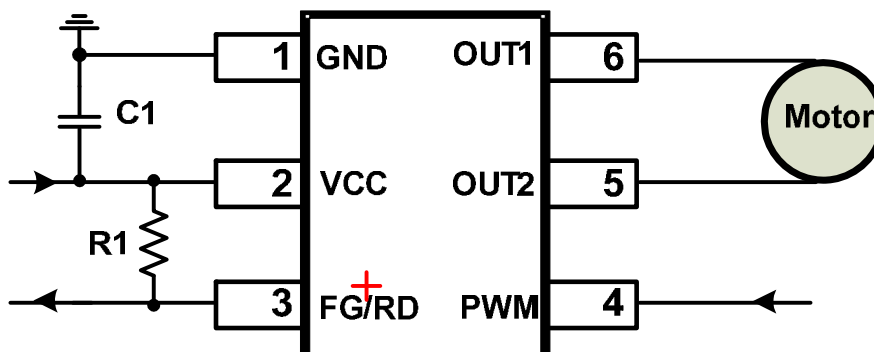

ORDERING INFORMATION

Part Number *	Package	Top Marking
MP6517GJ-xxxx **	TSOT23-6	<i>See Below</i>
MP6517GJS-xxxx **	TSOT23-6-SL	

* For Tape & Reel, add suffix -Z (e.g. MP MP6517GJS-Z).

** "xxxx" is the configuration code identifier for the register settings stored in the OTPROM. For the default case, the number is "0000". Each "x" can have a hexadecimal value between 0 and F. Please work with an MPS FAE to create this unique number, even if ordering the "0000" code.

TOP MARKING (MP6517GJ)

| ATAY

ATA: Product code of MP6517GJ
Y: Year code

TOP MARKING (MP6517GJS)

**ATAY
LLL**

ATA: Product code of MP6517GJS
Y: Year code
LLL: Lot number

PACKAGE REFERENCE

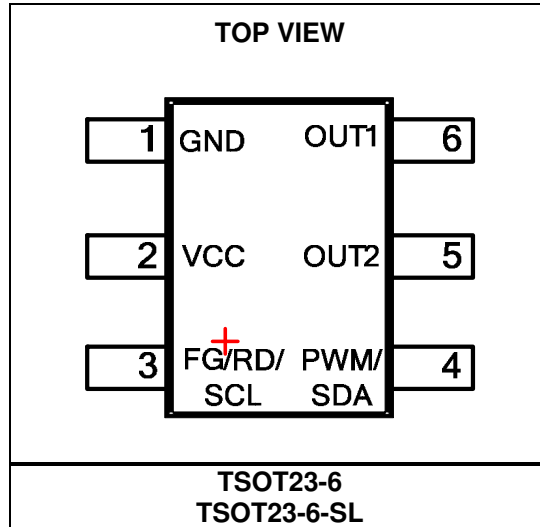

ABSOLUTE MAXIMUM RATINGS ⁽¹⁾

VCC	±19V
FG/RD, V _{OUT1/2}	-0.3V to VCC + 0.3V
All other pins	-0.3V to +6.5V
Continuous power dissipation (T _A = +25°C) ⁽²⁾	1.25W
Junction temperature	150°C
Lead temperature	260°C
Storage temperature	-60°C to 150°C

Recommended Operating Conditions ⁽³⁾

Supply voltage (VCC)	3.3V to 18V
Operating junction temp. (T _J) ...	-40°C to +125°C

Thermal Resistance ⁽⁴⁾	θ_{JA}	θ_{JC}
TSOT23-6	100.....	55... °C/W

NOTES:

- 1) Exceeding these ratings may damage the device.
- 2) The maximum allowable power dissipation is a function of the maximum junction temperature T_J (MAX), the junction-to-ambient thermal resistance θ_{JA}, and the ambient temperature T_A. The maximum allowable continuous power dissipation at any ambient temperature is calculated by P_D (MAX) = (T_J (MAX)-T_A)/θ_{JA}. Exceeding the maximum allowable power dissipation produces an excessive die temperature, causing the regulator to go into thermal shutdown. Internal thermal shutdown circuitry protects the device from permanent damage.
- 3) The device is not guaranteed to function outside of its operating conditions.
- 4) Measured on JESD51-7, 4-layer PCB.

ELECTRICAL CHARACTERISTICS

VCC = 12V, T_J = -40°C to 125°C, unless otherwise noted.

Parameters	Symbol		Min	Typ	Max	Units
Input UVLO rising threshold	V _{UVLO}			3		V
Input UVLO hysteresis				0.15		V
Operating supply current	I _{CC}			6.5		mA
Reverse supply current	I _{CCREV}	VCC = -18V			1	mA
PWM input high voltage	V _{PWMH}		1.5			V
PWM input low voltage	V _{PWML}				0.4	V
PWM input frequency	F _{PWM}		12		48	kHz
Min PWM input low-level time ⁽⁵⁾			200			ns
PWM input internal pull-up resistance				100		kΩ
HS switch-on resistance	R _{HSON}	I _O = 100mA, including reversed MOSFET		520		mΩ
LS switch-on resistance	R _{LSON}	I _O = 100mA		330		mΩ
Over-current limit protection threshold	I _{OCPL}		-20%	1.8	+20%	A
Output current limit	I _{LMT}	SUCL = 100	-15%	860	+15%	mA
Internal oscillator frequency	f _{CLK}		-15%	7	+15%	MHz
PWM output frequency	f _S		-15%	26	+15%	kHz
FG output low-level voltage	V _{FG L}	I _{FG/RD} = 3mA, V _{PULL} = 5V			0.35	V
FG leakage current					1	μA
Soft turn-on angle	θ _{SON 100}	SON_100 = 10000		23.9		°
Soft turn-off angle	θ _{SOFF 100}	SOFF_100 = 11111		45		°
Adjustable delay angle	θ _e	THETA_E = 0000		0		°
Rotor-lock detection time	T _{RD}			0.6		s
Minimum recommended magnetic field ⁽⁵⁾				±1		mT
Thermal shutdown threshold ⁽⁵⁾				150		°C
Thermal shutdown hysteresis ⁽⁵⁾				25		°C

NOTE:

5) Guaranteed by design.

TYPICAL PERFORMANCE CHARACTERISTICS

V_{CC} = 12V, T_A = 25°C, tested with fan unit, unless otherwise noted.

Typical Waveform, 100% Duty Output

V_{CC}=12V DC, PWM=25kHz, 100% Duty

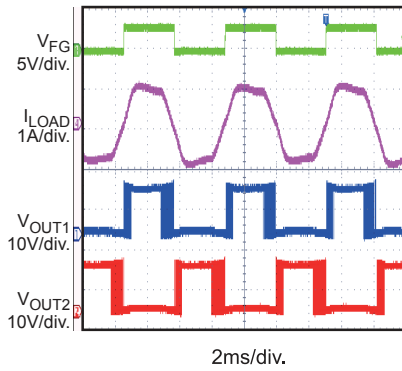

Typical Waveform, 50% Duty Output

V_{CC}=12V DC, PWM=25kHz, 50% Duty

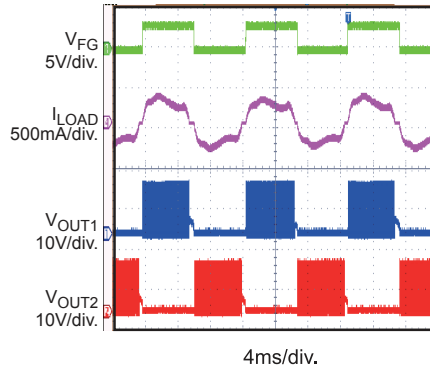

Typical Waveform, Switching Soft On & Soft Off

V_{CC}=12V DC, PWM= 5V DC, w/ soft on/off phase transition

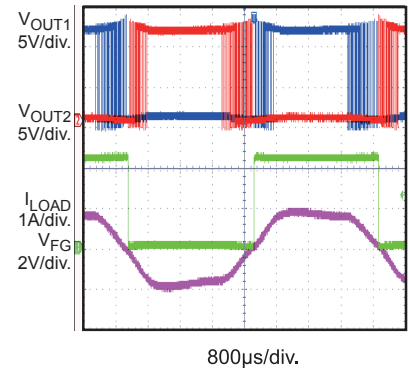

Typical Waveform, Enable Soft On & Soft Off

V_{CC}=12V DC, PWM= 5V DC, w/ soft on/off phase transition

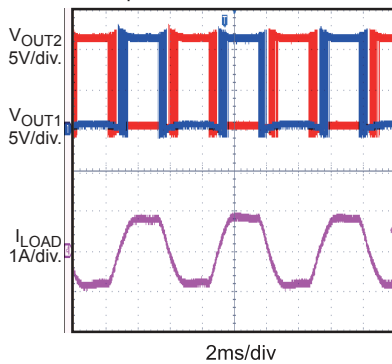

Typical Waveform, Disable Soft On & Soft Off

V_{CC}=12V DC, PWM= 5V DC, w/o soft on/off phase transition

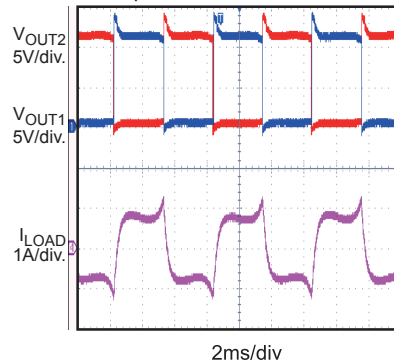

Typical Waveform, Start Up with PWM

V_{CC}=12V DC, PWM= 0V to 5V DC

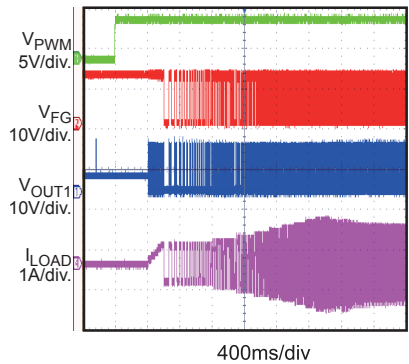

Typical Waveform, Shutdown with PWM

V_{CC}=12V DC, PWM=5V DC to 0V

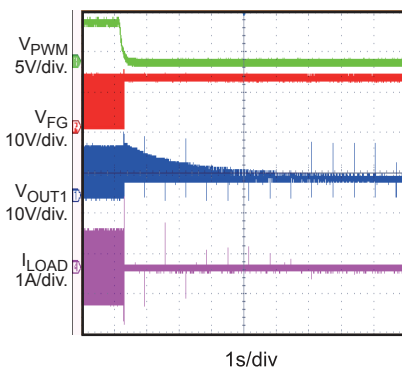

Typical Waveform, Start Up with VCC

PWM=5V DC, V_{CC}= 0V to 12V DC

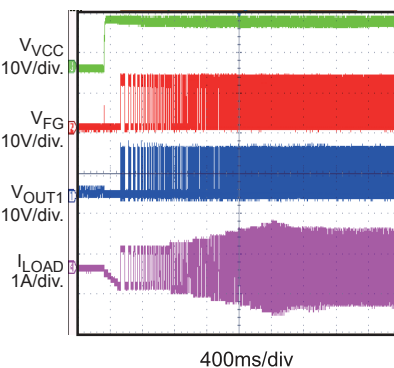

Typical Waveform, Shutdown with VCC

PWM=5V DC, V_{CC}=12V DC to 0V

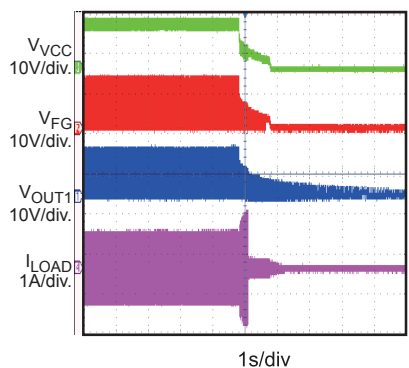

TYPICAL PERFORMANCE CHARACTERISTICS (continued)

V_{CC} = 12V, T_A = 25°C, tested with fan unit, unless otherwise noted.

Typical Waveform, Rotor Lock & Release

V_{CC}= 12V DC, PWM=5V DC, Lock Rotor and Release, Test with Fan Unit

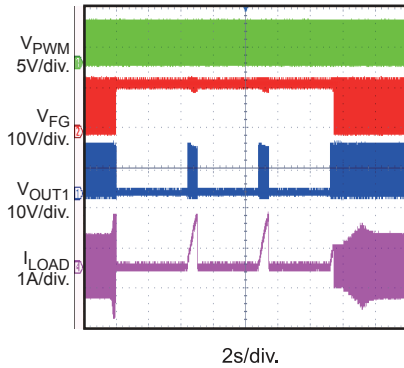

Typical Waveform, Rotor Lock & Release

V_{CC}= 12V DC, PWM=5V DC, Lock Rotor and Release, Test with Fan Unit

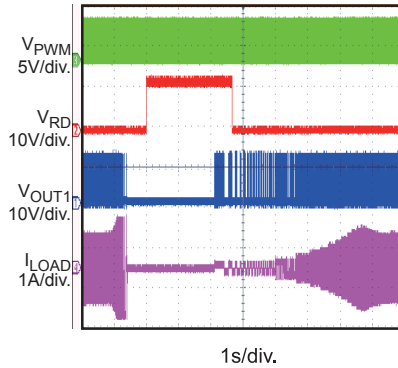

Typical Waveform, Over Voltage Protection

PWM= 25kHz, 50% duty, V_{CC}=12V DC to 20V DC to 18V DC, Test with Fan Unit

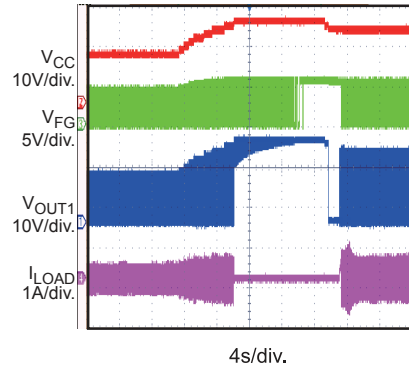

Typical Waveform, VCC Reverse Protection

V_{IN}= 0V to -18V DC to 0V to +18V DC

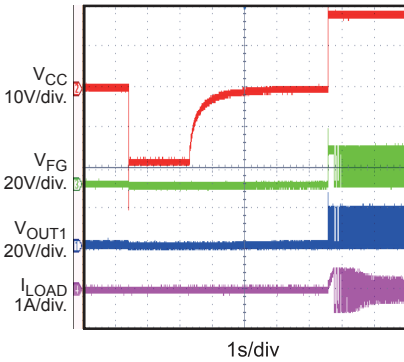

Typical Curve, RPM Output vs. PWM Input Duty

V_{CC}=12V DC, PWM=25kHz, Test with Fan Unit, Default Register Setting

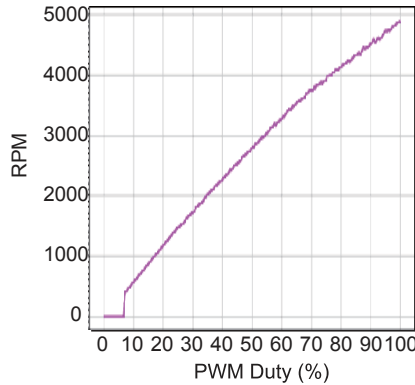

Typical Curve, RPM Output vs. PWM Input Duty

V_{CC}=12V DC, PWM=25kHz, Test with Fan Unit, Optimized Rpm Curve & Programmed by MPS GUI Software

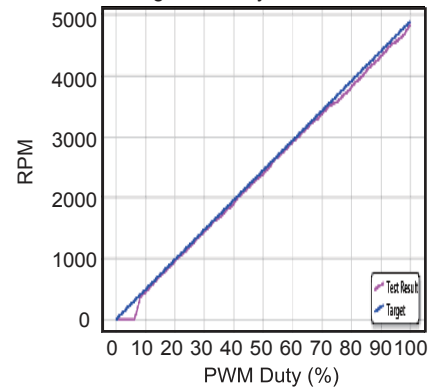

RPM Output Error vs. RPM Target

V_{CC}=12V DC, PWM=25kHz, Test with Fan Unit, Optimized Rpm Curve & Programmed by MPS GUI Software

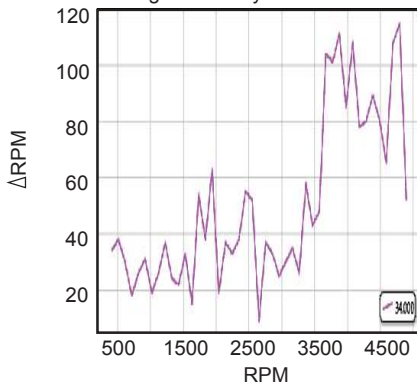

PIN FUNCTIONS

Pin #	Name	Description
1	GND	Ground.
2	VCC	Input voltage supply.
3	FG/RD/SCL	Speed indication or rotor lock fault indication output. This pin functions as I ² C SCL in test mode (TM).
4	PWM/SDA	Rotational speed control PWM input. PWM 12kHz to 48kHz is recommended in normal operation. PWM is an internal pull-up with 100kΩ of resistance to the internal LDO. This pin functions as I ² C SDA in test mode (TM).
5	OUT2	Motor driver output 2. OUT2 is connected to the mid-point of the internal N-channel MOSFET half-bridge.
6	OUT1	Motor driver output 1. OUT1 is connected to the mid-point of the internal N-channel MOSFET half-bridge.

BLOCK DIAGRAM

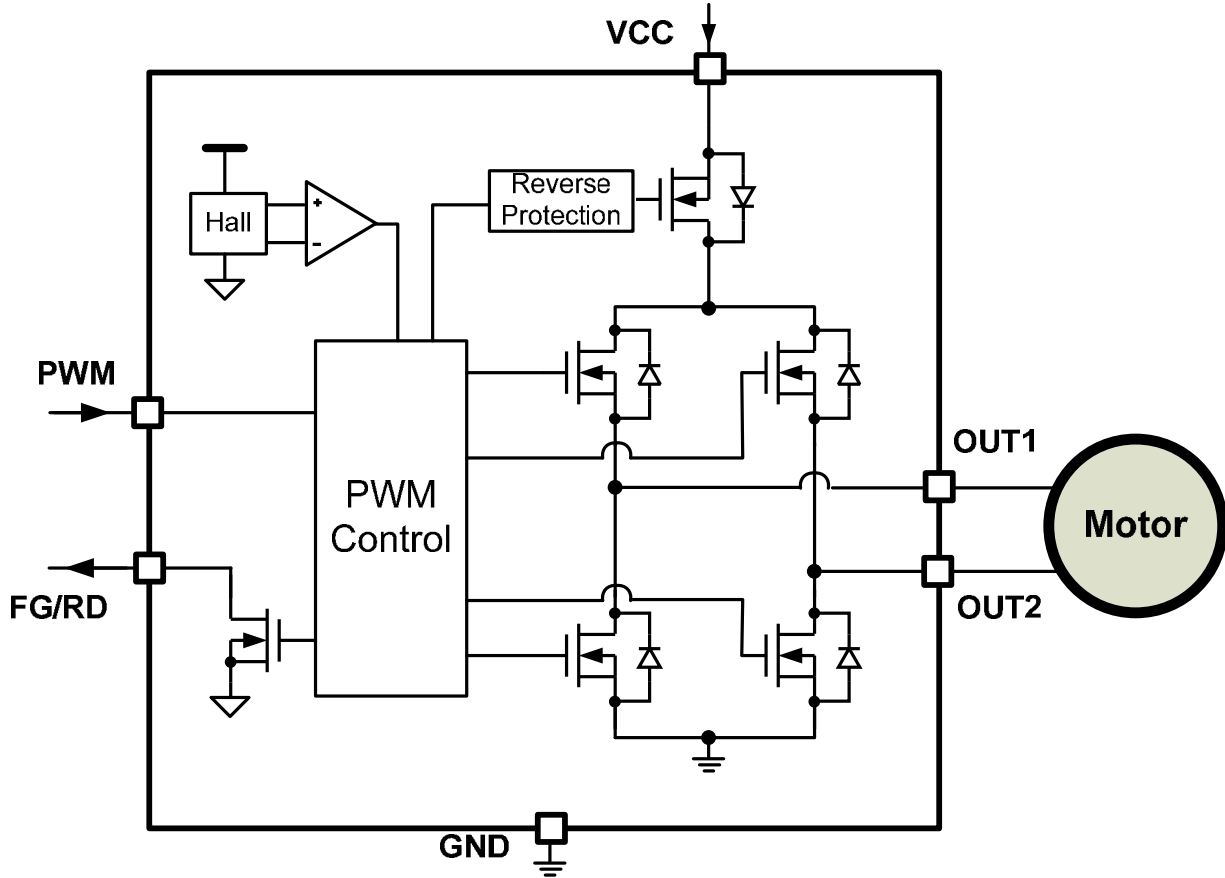

Figure 1: Functional Block Diagram

OPERATION

The MP6517 is a single-phase, brushless, DC motor driver with integrated power MOSFETs and a Hall effect sensor.

Speed Control

The MP6517 is controlled using a PWM input interface, which is compatible with industry-standard devices. The IC detects the PWM input signal duty cycle and linearly controls the H-bridge output duty cycle, so the fan speed increases as the input duty cycle increases.

The PWM input accepts a wide input frequency range (12kHz to 48kHz), while the output frequency is kept constant at 26kHz above the audible frequency range.

PWM Output Drive

The IC controls the H-bridge MOSFET switching to reduce speed variation and increase system efficiency (see Figure 2).

When the rotor magnet pole S comes around, the internal Hall sensor outputs high. When the rotor magnet pole N comes around, the internal Hall sensor outputs low. With this H_{A_IN} signal, the H_{A_OUT} signal is generated after the θ_e delay time, which is set from 0° to 15° through the register THETA_E bits. During the H_{A_OUT} high interval, the OUT2 and OUT1 switching status can be divided to different timing sections.

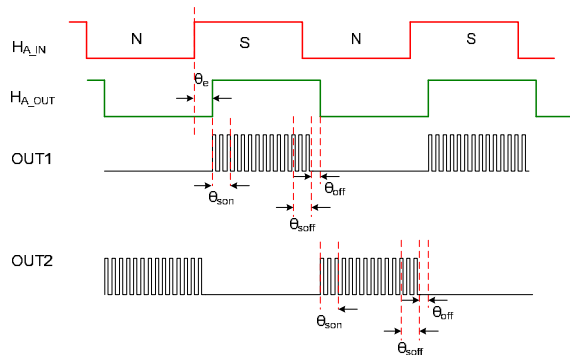

Figure 2: Timing Diagram

Soft Turn-On Section

During this time, OUT1 continues switching, and the duty cycle increases gradually from 0 to the target setting duty cycle in 16 steps max. OUT2 remains low. Determine the duration time from the linear interpolation between the

SON_100 and SON_12P5 bits setting value, which is in range of 1.45° to 45° in 32 steps.

Normal PWM Switching Section

During this time, OUT1 continues switching, and the duty cycle is fixed at the target setting duty. OUT2 remains low.

Soft Turn-Off Section

During this time, OUT1 continues switching, and the duty cycle decreases gradually from the target setting duty cycle to 0 in 16 steps max. OUT2 remains low. Determine the duration time from the linear interpolation between the SOFF_100 and SOFF_12P5 bits setting value, which is in range of 1.45° to 45° in 32 steps.

Off Section

During this time, OUT1 remains at high impedance. OUT2 remains low. The time duration is adaptive from 0° to 45° . In steady state, this function block tries to maintain the phase lock of the Hall output falling edge and winding current zero-crossing edge.

For Hall output low interval, the conducting phase changes, but the switching sequence remains the same.

Protection Circuits

The MP6517 is fully protected against over-voltage, under-voltage, over-current, over-temperature events, and input reverse protection.

Over-Current Protection (OCP)

The MP6517 protects against internal overload and short circuit by detecting the current flowing through each MOSFET. If the current flowing through any MOSFET exceeds the over-current protection (OCP) threshold after around $1.5\mu\text{s}$ of blanking time, that MOSFET turns off immediately. After approximately 3.6s of delay, the bridge is re-enabled automatically.

Overload Current Limit

During normal switching, if the current flowing through the high-side MOSFET (HS-FET) of the H-bridge exceeds the threshold set by the register SUCL bits after around $1.5\mu\text{s}$ of blanking time, the HS-FET turns off immediately. The HS-FET resumes switching in the next switching cycle. The overload current limit is fixed at around 860mA. To spin-up the fan

driver softly during start-up, the current limit increases from 0 to the programmed current limit in 16 steps (see Figure 3). Each step limit value lasts for 16 internal Hall cycles. In rotor lock fault cases, the current limit increases with 16 steps with 600ms of detection time.

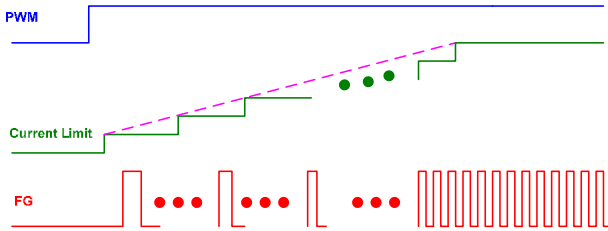

Figure 3: Start-Up Waveforms

Thermal Shutdown

Thermal monitoring is also integrated into the MP6517. If the die temperature rises above 150°C, the MOSFETs of the switching half-bridge turn off. Once the die temperature has fallen to a safe level, operation resumes automatically.

Under-Voltage Lockout (UVLO)

If at any time VCC falls below the under-voltage lockout threshold (UVLO) voltage, all circuitry in the device is disabled, and the internal logic is reset. Operation resumes when VCC rises above the UVLO threshold.

Rotor Deadlock Protection (RD)

The MP6517 detects the internal Hall signal and outputs deadlock indication signal to FG/RD if the FGRD bit set to 11. If the IC cannot see the Hall signal edge change during the 0.6s detection time, all MOSFETs of the H-bridge are turned off. FG/RD is an open-drain output. After 1.8, 2.4, 3, or 3.6s of recovery time (depending on the RLOCK_SEL bits setting), the IC attempts to start up again automatically. FG/RD is pulled low again only after three Hall signal edges are detected after the rotor lock condition is released (see Figure 4).

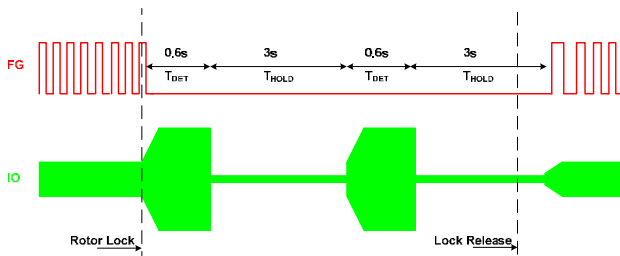

Figure 4: Rotor Deadlock Protection

Rotor Speed Indication (FG)

The MP6517 outputs a Hall detection signal to FG/RD as speed indication. The output signal frequency can be optional for 1x, 0.5x, and 2x the internal Hall sensor output frequency. FG/RD is an open-drain, so it needs a pull-up resistor in application.

Over-Voltage Protection (OVP)

If VCC exceeds the over-voltage threshold (19V), the IC turns off the H-bridge MOSFETs until VCC drops. Then the IC resumes normal operation.

Input Reverse Connection Protection

If the input line is reverse-connected to VCC and GND, the IC detects such fault conditions automatically and shuts down to avoid damage.

Test Mode and Factory Mode

With VCC powered, the IC enters test mode by sourcing 5~10mA of current with an external resistor and negative voltage for around 200µs. In test mode, all functions blocks are active, and PWM and FG/RD can be used as the I²C interface to read/write the internal register bits (see Figure 5).

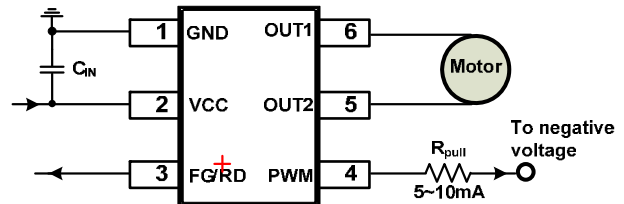

Figure 5: Test Mode Configuration

In test mode, first write the data 28H to the register (11H), and then write the data 04H to the register (10H). In factory mode, all writable registers value can be programmed twice. The IC exits test mode or factory mode when the VCC power is recycled.

I²C Chip Address

After the start condition, the I²C-compatible master sends a seven-bit address followed by an eighth read (1) or write (0) bit. The following bit indicates the register address to/from which the data will be written/read (see Figure 6).

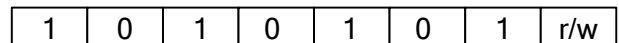

Figure 6: I²C Compatible Device Address

REGISTER MAPPING

Add	Type	D7	D6	D5	D4	D3	D2	D1	D0
00H	OTP/REG	PWMO[7:0]							
01H-08H	OTP/REG	PWMO[7:0]							
09H	OTP/REG	PROG[1:0]		PCODE[5:0]					
0AH	OTP/REG	FGRD[1:0]		RPMS[2:0]			SUCL[2:0]		
0BH	OTP/REG	FG	TM	HLL_CALI	SON_12P5[4:0]				
0CH	OTP/REG				SON_100[4:0]				
0DH	OTP/REG		SOFTEN	RD_HL	SOFF_12P5[4:0]				
0EH	OTP/REG				SOFF_100[4:0]				
0FH	OTP/REG		PLLEN	RLOCK_SEL[1:0]		THETA_E[3:0]			
10H	REG	Reserved					FM	Reserved	
11H-13H	REG	Reserved							

Register Table 1 - 9

Addr: 0x00 - 0x08				
Bit	Bit Name	Access	Default	Description
7:0	PWMO	OTP/REG	00000000	Output duty cycle lookup table. Default = linear mode.

Register Table 10

Addr: 0x09				
Bit	Bit Name	Access	Default	Description
7:6	PROG	OTP/REG	00	Indication of OTP flash. 00: not programmed 01: programmed once 10: programmed twice
5:0	PROC	OTP/REG	000000	The project code of design. Default = 000000.

Register Table 11

Addr: 0x0A				
Bit	Bit Name	Access	Default	Description
7:6	FGRD	OTP/REG	00	FG or RD output selection. 00 = FG 01 = 1/2fs*FG 10 = 2fs*FG 11 = RD
5:3	RPMS	OTP/REG	011	Rotor RPM operating range selection. 000: 50 to 800 RPM 001: 100 to 1600 RPM 010: 200 to 3200 RPM 011: 400 to 6400 RPM 100: 800 to 12800 RPM 101: 1600 to 25600 RPM 110: 3200 to 51200 RPM
2:0	SUCL	OTP/REG	100	Start-up current limit. Default is 860mA. 000 = 320mA 111 = 1265mA 135mA/step

Register Table 12

Addr: 0x0B				
Bit	Bit Name	Access	Default	Description
7	FG	REG	0	FG signal indication bit (read only).
6	TM	REG	0	Test mode indication (read only). In test mode, turn on all other functions but OTP flash block. When in POR, if PWM is negative, enter test mode. TM bit is set to 1. Recycle the power to clear the test mode and TM bit. 0: normal operation 1: test mode
5	HLL_CALI	OTP/REG	0	Hall period calibration enable. 1: enable 0: disable
4:0	SON_12P5	OTP/REG	11111	The electrical angle to turn on the phase transition softly at 12.5% PWM output duty. Default = 11111. 00000 = 1.4° 11111 = 45°

Register Table 13

Addr: 0x0C				
Bit	Bit Name	Access	Default	Description
7:5	Reserved			
4:0	SON_100	OTP/REG	10000	The electrical angle to turn on the phase transition softly at 100% PWM output duty. Default is 23.9°. 00000 = 1.4° 11111 = 45°

Register Table 14

Addr: 0x0D				
Bit	Bit Name	Access	Default	Description
7	Reserved			
6	SOFTEN	OTP/REG	1	Soft switching function enable bit. 1: soft function is enabled 0: soft function is disabled
5	RD_HL	OTP/REG	0	RD polarity set when rotor is locked. Default is 0. 0: RD high when locked 1: RD low when locked
4:0	SOFF_12P5	OTP/REG	10000	The electrical angle to turn off the phase transition softly at 12.5% PWM output duty. Default is 23.9°. 00000 = 1.4° 11111 = 45°

Register Table 15

Addr: 0x0E				
Bit	Bit Name	Access	Default	Description
7:5	Reserved			
4:0	SOFF_100	OTP/REG	11111	The electrical angle to turn off the phase transition softly at 100% PWM output duty. 00000 = 1.4° 11111 = 45°

Register Table 16

Addr: 0x0F				
Bit	Bit Name	Access	Default	Description
7	Reserved			
6	PLLEN	OTP/REG	1	Load current zero-crossing PLL function enable bit. 1: enable 0: disable
5:4	RLOCK_SEL	OTP/REG	11	Rotor-lock off-time to detection time ratio selection. Rotor lock-off timer also determines the OLP retry time. 00 = 1:3 (0.6s/1.8s) 01 = 1:4 (0.6s/2.4s) 10 = 1:5 (0.6s/3.0s) 11 = 1:6 (0.6s/3.6s)
3:0	THETA_E	OTP/REG	0000	The electrical angle delay setting bits between the original Hall signal positive edge and output current zero-crossing positive edge. 1° per step. 0000 = 0° 1111 = 15°

Register Table 17

Addr: 0x10				
Bit	Bit Name	Access	Default	Description
7:3	Reserved			Write this bit to 00000 during OTP programming.
2	FM	REG	0	Factory mode enable.
1:0	Reserved	REG	00	Write this bit to 00 when not in use.

Register Table 18

Addr: 0x11				
Bit	Bit Name	Access	Default	Description
7:0				Write 28H to this register first before OTP programming.

Register Table 19 - 20

Addr: 0x12 - 0x13				
Bit	Bit Name	Access	Default	Description
7:0	Reserved			Reserved.

APPLICATION INFORMATION

Selecting the Input Capacitor

Place an input capacitor (C1) near VCC to keep the input voltage stable and to reduce input switching voltage noise and ripple. The input capacitor impedance must be low at the switching frequency. Ceramic capacitors with X7R dielectrics are recommended for their low ESR characteristics. Ensure that the ceramic capacitance is dependent on the voltage rating. The DC bias voltage and value can lose as much as 50% of its capacitance at its rated voltage rating. Leave enough voltage rating margin when selecting the component. For most applications, a 1 μ F to 10 μ F ceramic capacitor is sufficient. In some applications, add an additional, large, electrolytic capacitor to absorb armature inductor energy if needed.

Selecting the PWM Input Resistor

When the input PWM signal rating is >6.5V, which exceeds the PWM voltage rating, a resistor (R2) is needed. The recommended value is 499 Ω .

Hall Sensor Position

The Hall sensor cell is located in the lower left corner of the package (see Figure 7).

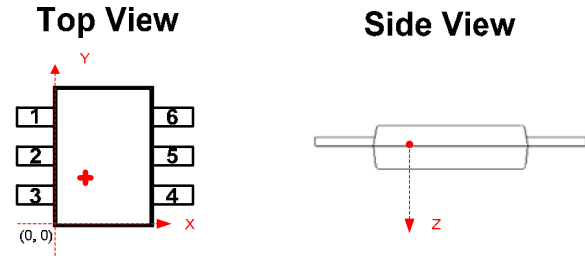

(X, Y, Z) = (540 μ m, 508 μ m, 80 μ m)

Figure 7: Hall Sensor Position

Input Clamping Zener Diode

To avoid voltage spikes caused by the energy stored in the motor charges back to the input capacitor side, add a voltage-clamping Zener diode. For a 12V case, a 15V/SOD-323 package Zener diode is sufficient. If input connection reserve protection is needed, a diode in series with a Zener diode is recommended (see Section 1 in Figure 8).

Input Snubber

Due to the input capacitor energy charge/discharge during the phase transition soft switching, the input current has switching cycle ringing. If needed, add a 2 Ω resistor in series with a 1 μ F capacitor as an R-C snubber in parallel with an input capacitor. This prevents switching cycle ringing efficiently (see Section 2 in Figure 8).

TYPICAL APPLICATION CIRCUIT

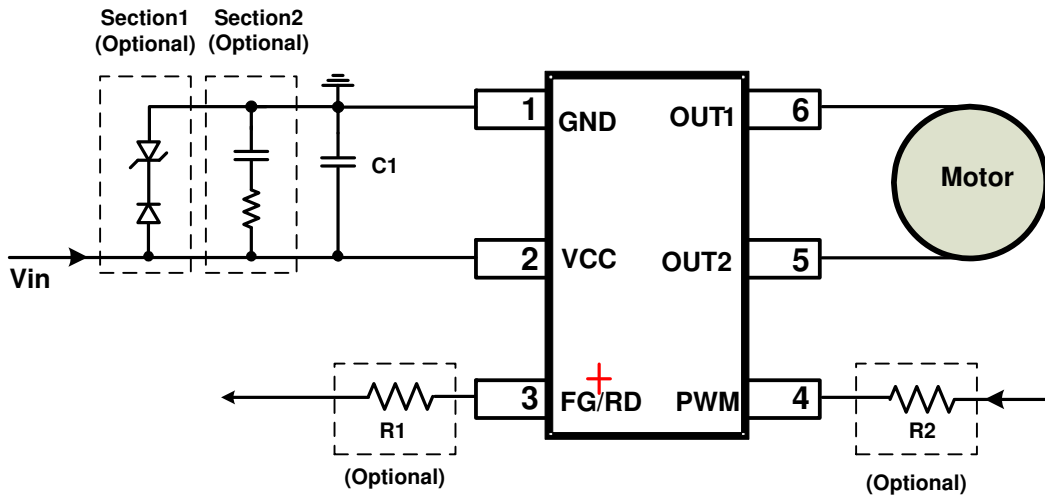
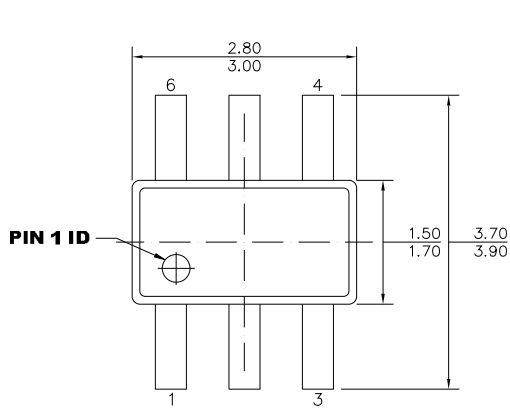
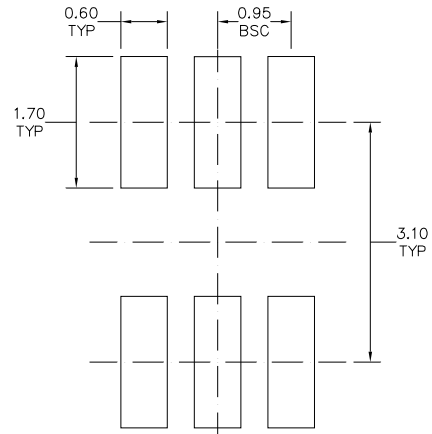
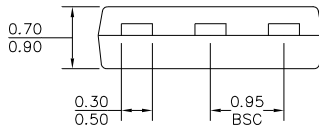
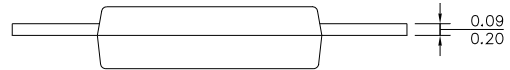
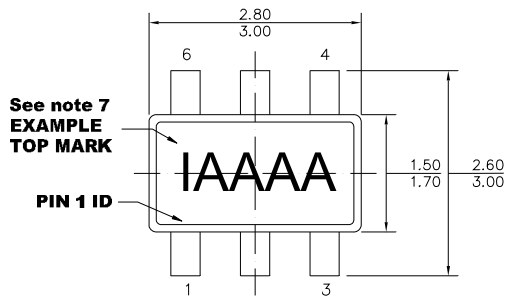
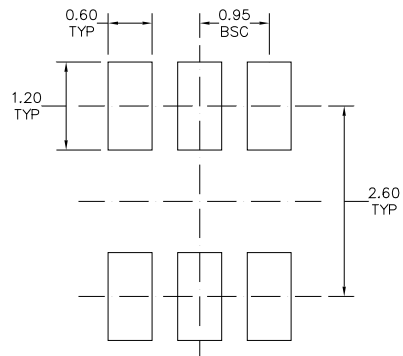
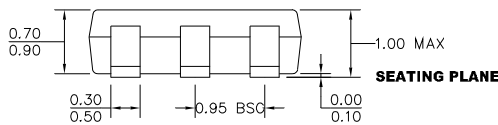
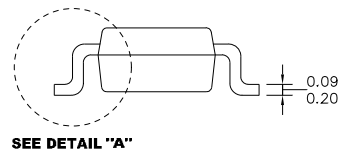
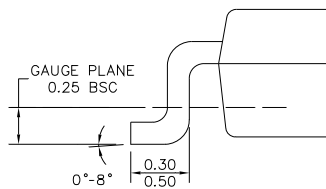

Figure 8: Typical Application Circuit for 12V VCC Input

PACKAGE INFORMATION
TSOT23-6-SL

TOP VIEW

RECOMMENDED LAND PATTERN

FRONT VIEW

SIDE VIEW
NOTE:

- 1) ALL DIMENSIONS ARE IN MILLIMETERS.
- 2) PACKAGE LENGTH DOES NOT INCLUDE MOLD FLASH, PROTRUSION OR GATE BURR.
- 3) PACKAGE WIDTH DOES NOT INCLUDE INTERLEAD FLASH OR PROTRUSION.
- 4) LEAD COPLANARITY (BOTTOM OF LEADS AFTER FORMING) SHALL BE 0.10 MILLIMETERS MAX.
- 5) DRAWING REFERENCE IS JEDEC MO-193.
- 6) DRAWING IS NOT TO SCALE.

PACKAGE INFORMATION (continued)
TSOT23-6L

TOP VIEW

RECOMMENDED LAND PATTERN

FRONT VIEW

SEE DETAIL "A"
SIDE VIEW

DETAIL "A"
NOTE:

- 1) ALL DIMENSIONS ARE IN MILLIMETERS.
- 2) PACKAGE LENGTH DOES NOT INCLUDE MOLD FLASH, PROTRUSION OR GATE BURR.
- 3) PACKAGE WIDTH DOES NOT INCLUDE INTERLEAD FLASH OR PROTRUSION.
- 4) LEAD COPLANARITY (BOTTOM OF LEADS AFTER FORMING) SHALL BE 0.10 MILLIMETERS MAX.
- 5) DRAWING CONFORMS TO JEDEC MO-193, VARIATION AB.
- 6) DRAWING IS NOT TO SCALE.
- 7) PIN 1 IS LOWER LEFT PIN WHEN READING TOP MARK FROM LEFT TO RIGHT, (SEE EXAMPLE TOP MARK)

NOTICE: The information in this document is subject to change without notice. Users should warrant and guarantee that third party Intellectual Property rights are not infringed upon when integrating MPS products into any application. MPS will not assume any legal responsibility for any said applications.