

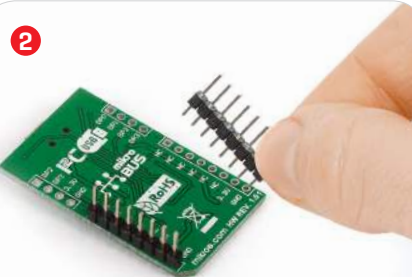

## USB I2C click

### 2. Soldering the headers

Before using your click board™, make sure to solder 1x8 male headers to both left and right side of the board. Two 1x8 male headers are included with the board in the package.

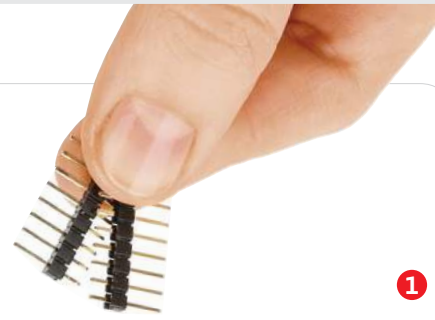

Turn the board upside down so that the bottom side is facing you upwards. Place shorter pins of the header into the appropriate soldering pads.

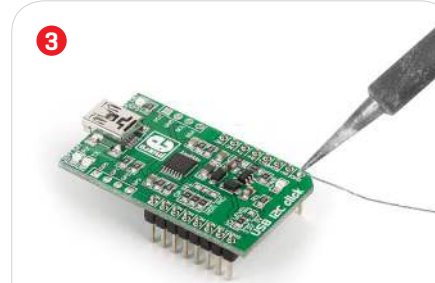

Turn the board upward again. Make sure to align the headers so that they are perpendicular to the board, then solder the pins carefully.

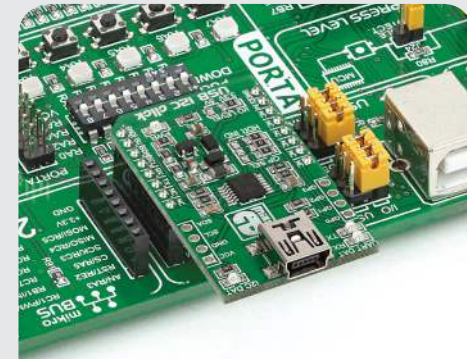

### 4. Essential features

The chip supports full-speed USB (**12 Mb/s**), I<sup>2</sup>C with up to **400 kHz** clock rates and UART baud rates between **300 and 115200**. The USB has a 128-byte Buffer [64-Byte Transmit and 64-byte Receive] supporting data throughput at any of those baud rates. The I<sup>2</sup>C interface supports up to 65,535-byte long Reads/Writes Blocks. The board is also supported with Microchip's configuration utility and drivers for Linux, Mac, Windows and Android.

### 1. Introduction

USB I<sup>2</sup>C click carries an **MCP2221 USB-to-UART/I<sup>2</sup>C** protocol converter. The board communicates with the target microcontroller through mikroBUS™ UART [RX, TX] or I<sup>2</sup>C [SCL, SDA] interfaces. In addition to mikroBUS™, the edges of the board are lined with additional GPIO [GPO-GP3] and I<sup>2</sup>C pins [SCL, SDA plus VCC and GND]. It can operate on 3.3V or 5V logic levels.

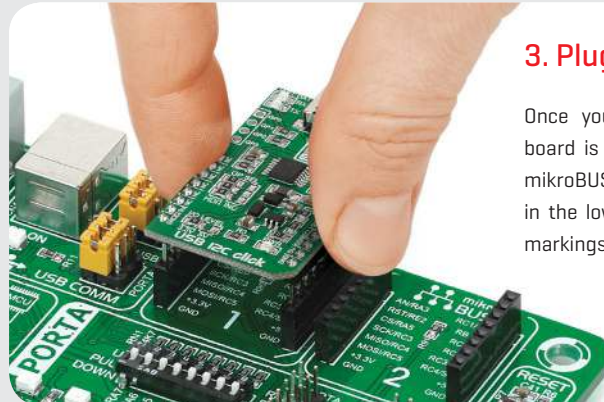

### 3. Plugging the board in

Once you have soldered the headers your board is ready to be placed into the desired mikroBUS™ socket. Make sure to align the cut in the lower-right part of the board with the markings on the silkscreen at the mikroBUS™ socket. If all the pins are aligned correctly, push the board all the way into the socket.

**click**  
BOARD™  
[www.mikroe.com](http://www.mikroe.com)



USB I2C click Manual v101



0100000085455

## 5. Schematic

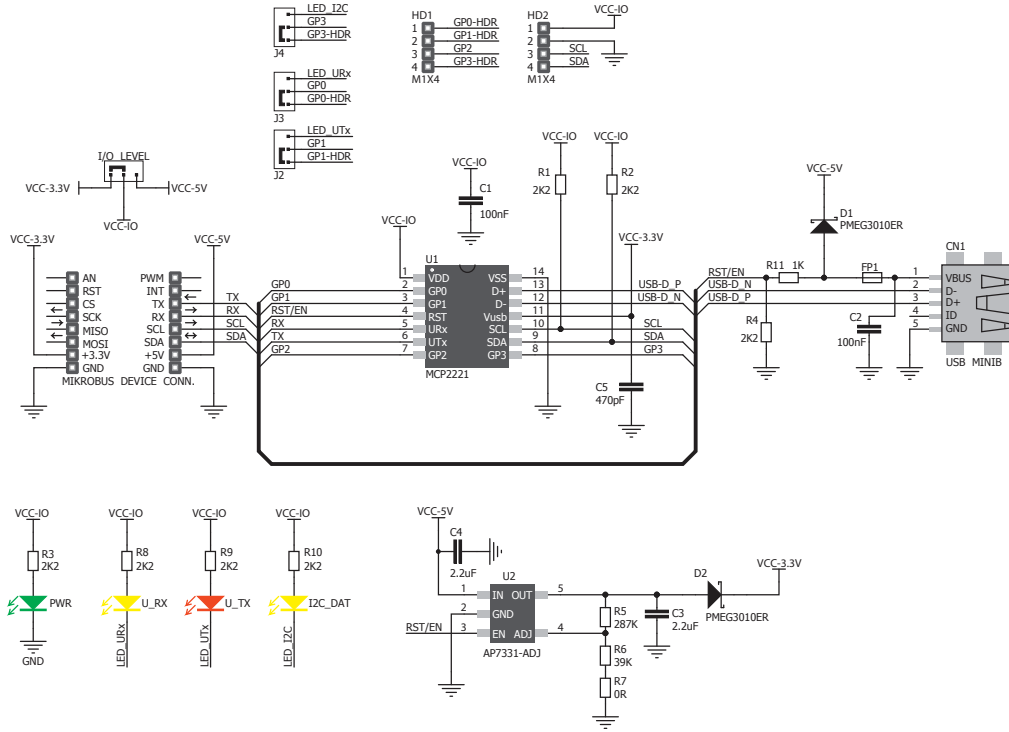

## 6. Dimensions

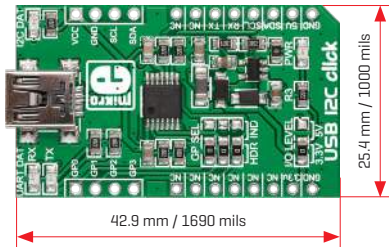

	mm	mils
LENGTH	42.9	1690
WIDTH	25.4	1000
HEIGHT*	3.9	154

\* without headers

## 7. Two sets of SMD jumpers

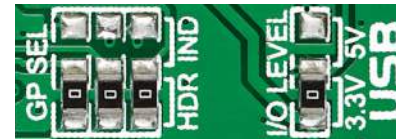

GP SEL is for specifying whether the GPO I/Os will be connected to the pinout, or used to power signal LEDs. I/O LEVEL jumpers are for switching between 3.3V or 5V logic.

## 8. Code examples

Once you have done all the necessary preparations, it's time to get your click board™ up and running. We have provided examples for mikroC™, mikroBasic™ and mikroPascal™ compilers on our **Libstock** website. Just download them and you are ready to start.



## 9. Support

MikroElektronika offers **free tech support** [[www.mikroe.com/support](http://www.mikroe.com/support)] until the end of the product's lifetime, so if something goes wrong, we're ready and willing to help!



## 10. Disclaimer

MikroElektronika assumes no responsibility or liability for any errors or inaccuracies that may appear in the present document. Specification and information contained in the present schematic are subject to change at any time without notice.

Copyright © 2015 MikroElektronika. All rights reserved.