



Is Now Part of



ON Semiconductor®

To learn more about ON Semiconductor, please visit our website at
www.onsemi.com

Please note: As part of the Fairchild Semiconductor integration, some of the Fairchild orderable part numbers will need to change in order to meet ON Semiconductor's system requirements. Since the ON Semiconductor product management systems do not have the ability to manage part nomenclature that utilizes an underscore (_), the underscore (_) in the Fairchild part numbers will be changed to a dash (-). This document may contain device numbers with an underscore (_). Please check the ON Semiconductor website to verify the updated device numbers. The most current and up-to-date ordering information can be found at www.onsemi.com. Please email any questions regarding the system integration to Fairchild_questions@onsemi.com.

ON Semiconductor and the ON Semiconductor logo are trademarks of Semiconductor Components Industries, LLC dba ON Semiconductor or its subsidiaries in the United States and/or other countries. ON Semiconductor owns the rights to a number of patents, trademarks, copyrights, trade secrets, and other intellectual property. A listing of ON Semiconductor's product/patent coverage may be accessed at www.onsemi.com/site/pdf/Patent-Marking.pdf. ON Semiconductor reserves the right to make changes without further notice to any products herein. ON Semiconductor makes no warranty, representation or guarantee regarding the suitability of its products for any particular purpose, nor does ON Semiconductor assume any liability arising out of the application or use of any product or circuit, and specifically disclaims any and all liability, including without limitation special, consequential or incidental damages. Buyer is responsible for its products and applications using ON Semiconductor products, including compliance with all laws, regulations and safety requirements or standards, regardless of any support or applications information provided by ON Semiconductor. "Typical" parameters which may be provided in ON Semiconductor data sheets and/or specifications can and do vary in different applications and actual performance may vary over time. All operating parameters, including "Typicals" must be validated for each customer application by customer's technical experts. ON Semiconductor does not convey any license under its patent rights nor the rights of others. ON Semiconductor products are not designed, intended, or authorized for use as a critical component in life support systems or any FDA Class 3 medical devices or medical devices with a same or similar classification in a foreign jurisdiction or any devices intended for implantation in the human body. Should Buyer purchase or use ON Semiconductor products for any such unintended or unauthorized application, Buyer shall indemnify and hold ON Semiconductor and its officers, employees, subsidiaries, affiliates, and distributors harmless against all claims, costs, damages, and expenses, and reasonable attorney fees arising out of, directly or indirectly, any claim of personal injury or death associated with such unintended or unauthorized use, even if such claim alleges that ON Semiconductor was negligent regarding the design or manufacture of the part. ON Semiconductor is an Equal Opportunity/Affirmative Action Employer. This literature is subject to all applicable copyright laws and is not for resale in any manner.



FAN2360

10 A Synchronous Buck Regulator

Features

- V_{IN} Range: 4.5 V to 24 V
- High Efficiency: Over 96% Peak
- Continuous Output Current: 10 A
- PFM Mode for Light-Load Efficiency
- Excellent Line and Load Transient Response
- Precision Reference: $\pm 1\%$ Over Temperature
- Output Voltage Range: 0.6 to 5.5 V
- Programmable Frequency: 200 kHz to 1.5 MHz
- Programmable Soft-Start
- Low Shutdown Current
- Adjustable Sourcing Current Limit
- Internal Boot Diode
- Thermal Shutdown
- Halogen and Lead Free, RoHS Compliant

Applications

- Mainstream Notebooks
- Servers and Desktop Computers
- Game Consoles
- Telecommunications
- Storage
- Base Stations

Description

The FAN2360 is a highly efficient synchronous buck regulator. The regulator is capable of operating with an input range from 4.5 V to 24 V and supporting up to 10 A continuous load currents.

The FAN2360 utilizes Fairchild's constant on-time control architecture to provide excellent transient response and to maintain a relatively constant switching frequency. This device utilizes Pulse Frequency Modulation (PFM) mode to maximize light-load efficiency by reducing switching frequency when the inductor is operating in discontinuous conduction mode at light loads, while clamping the minimum frequency above the audible range with ultrasonic mode.

Switching frequency and over-current protection can be programmed to provide a flexible solution for various applications. Output over-voltage, under-voltage, over-current, and thermal shutdown protections help prevent damage to the device during fault conditions. After thermal shutdown is activated, a hysteresis feature restarts the device when normal operating temperature is reached.

Ordering Information

Part Number	Configuration	Operating Temperature Range	Output Current (A)	Package
FAN2360MPX	PFM with Ultrasonic Mode	-40 to 125°C	10	34-Lead, PQFN, 5.5 mm x 5.0 mm

Typical Application Diagram

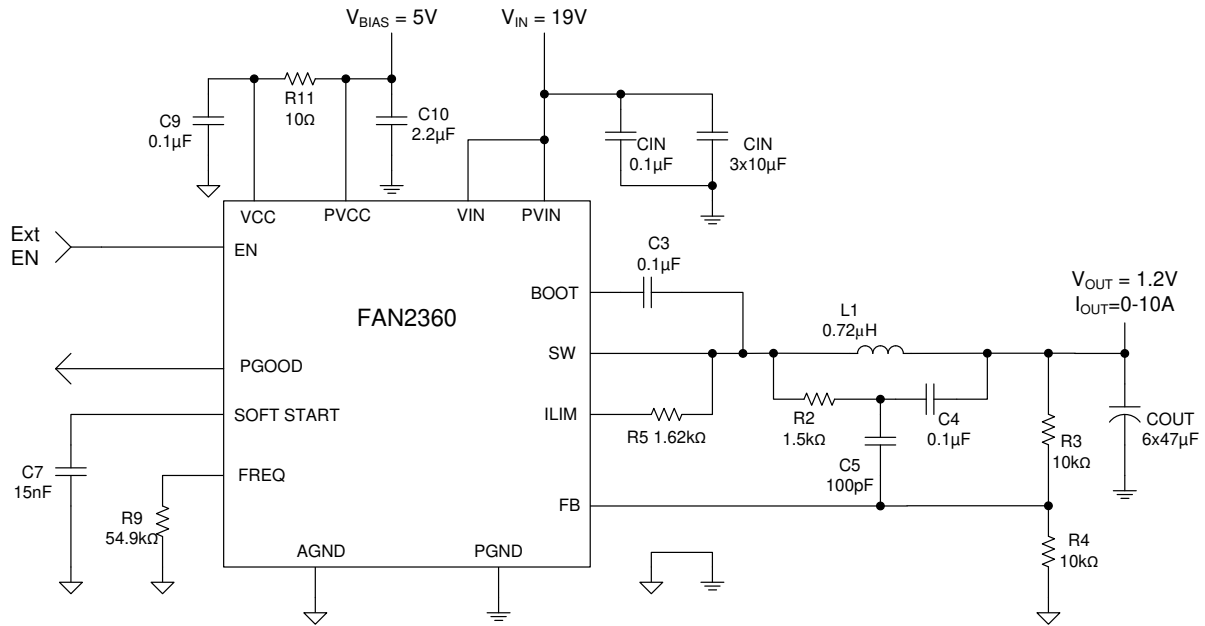

Figure 1. Typical Application

Functional Block Diagram

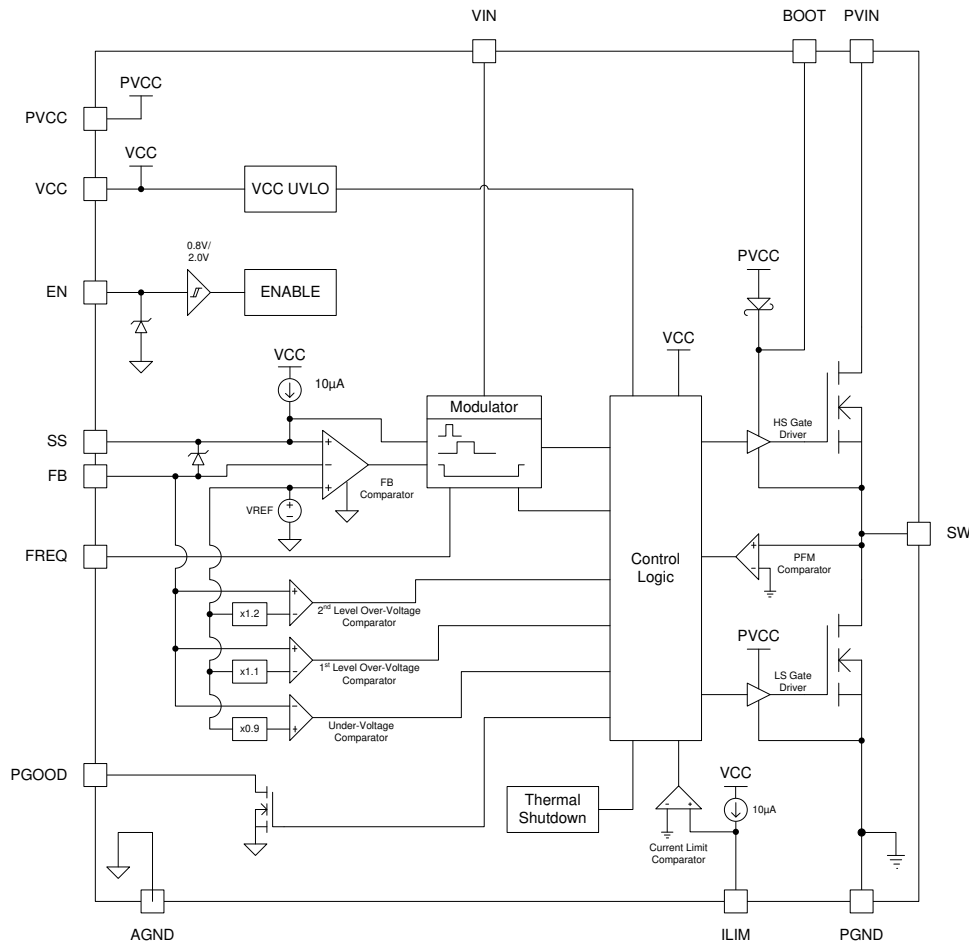

Figure 2. Block Diagram

Pin Configuration

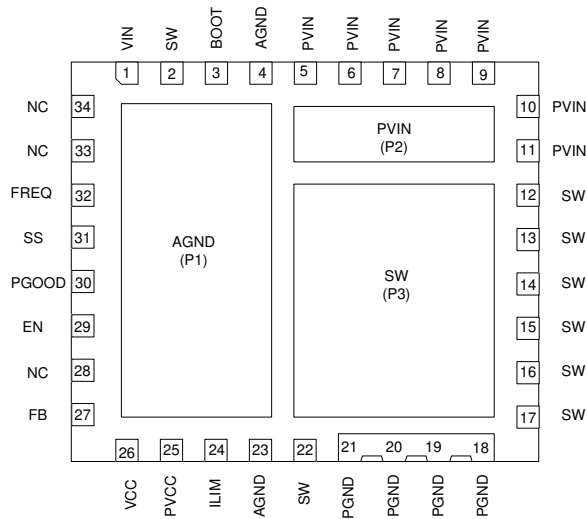

Figure 3. Pin Assignments(Bottom View)

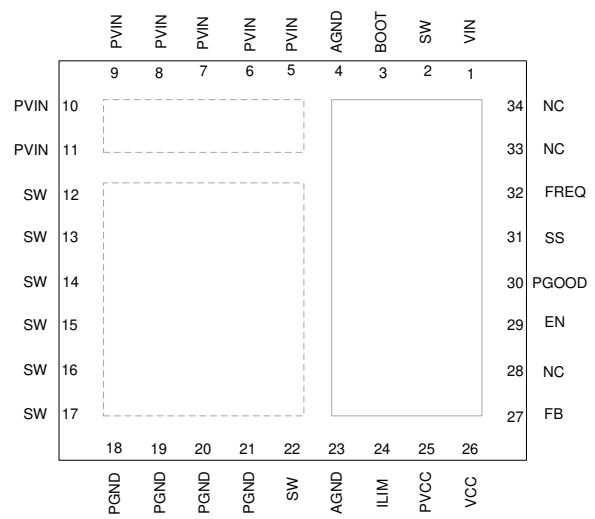

Figure 4. Pin Assignments(Top View)

Pin Definitions

Name	Pad / Pin	Description
PVIN	P2, 5-11	Power input for the power stage
VIN	1	Input to the modulator for input voltage feed-forward
PVCC	25	Power input for the low-side gate driver and boot diode
VCC	26	Power supply input for the controller
PGND	18-21	Power ground for the low-side power MOSFET and for the low-side gate driver
AGND	P1, 4, 23	Analog ground for the analog portions of the IC and for substrate
SW	P3, 2, 12-17, 22	Switching node; junction between high-and low-side MOSFETs
BOOT	3	Supply for high-side MOSFET gate driver. A capacitor from BOOT to SW supplies the charge to turn on the N-channel high-side MOSFET. During the freewheeling interval (low-side MOSFET on), the high-side capacitor is recharged by an internal diode connected to PVCC.
ILIM	24	Current limit. A resistor between ILIM and SW sets the current limit threshold.
FB	27	Output voltage feedback to the modulator
EN	29	Enable input to the IC. Pin must be driven logic high to enable, or logic low to disable.
SS	31	Soft-start input to the modulator
FREQ	32	On-time and frequency programming pin. Connect a resistor between FREQ and AGND to program on-time and switching frequency.
PGOOD	30	Power good; open-drain output indicating V_{OUT} is within set limits.
NC	28, 33-34	Leave pin open or connect to AGND.

Absolute Maximum Ratings

Stresses exceeding the absolute maximum ratings may damage the device. The device may not function or be operable above the recommended operating conditions and stressing the parts to these levels is not recommended. In addition, extended exposure to stresses above the recommended operating conditions may affect device reliability. The absolute maximum ratings are stress ratings only.

Symbol	Parameter	Conditions	Min.	Max.	Unit
V _{PVIN}	Power Input	Referenced to PGND	-0.3	30.0	V
V _{IN}	Modulator Input	Referenced to AGND	-0.3	30.0	V
V _{BOOT}	Boot Voltage	Referenced to PVCC	-0.3	30.0	V
		Referenced to PVCC, <20 ns	-0.3	33.0	V
V _{SW}	SW Voltage to GND	Referenced to PGND, AGND	-1	30	V
		Referenced to PGND, AGND < 20 ns	-5	30	V
V _{BOOT}	Boot to SW Voltage	Referenced to SW	-0.3	6.0	V
	Boot to PGND	Referenced to PGND	-0.3	30	V
V _{PVCC}	Gate Drive Supply Input	Referenced to PGND, AGND	-0.3	6.0	V
V _{VCC}	Controller Supply Input	Referenced to PGND, AGND	-0.3	6.0	V
V _{LIM}	Current Limit Input	Referenced to AGND	-0.3	6.0	V
V _{FB}	Output Voltage Feedback	Referenced to AGND	-0.3	6.0	V
V _{EN}	Enable Input	Referenced to AGND	-0.3	6.0	V
V _{SS}	Soft Start Input	Referenced to AGND	-0.3	6.0	V
V _{FREQ}	Frequency Input	Referenced to AGND	-0.3	6.0	V
V _{PGOOD}	Power Good Output	Referenced to AGND	-0.3	6.0	V
ESD	Electrostatic Discharge	Human Body Model, JESD22-A114 ⁽¹⁾		2000	V
		Charged Device Model, JESD22-C101 ⁽²⁾		2500	V
T _J	Junction Temperature			+150	°C
T _{STG}	Storage Temperature		-55	+150	°C

Note:

1. Exception for FB pin up to 350V
2. Exception for FB pin up to 500V

Recommended Operating Conditions

The Recommended Operating Conditions table defines the conditions for actual device operation. Recommended operating conditions are specified to ensure optimal performance to the datasheet specifications. Fairchild does not recommend exceeding them or designing to Absolute Maximum Ratings.

Symbol	Parameter	Min.	Typ.	Max.	Unit
V _{PVIN}	Power Input	Referenced to PGND	4.5	24	V
V _{IN}	Modulator Input	Referenced to AGND	4.5	24	V
T _J	Junction Temperature		-40	+125	°C
I _{LOAD}	Load Current	T _A =25°C, No Airflow		15	A
V _{PVCC}	Gate Drive Supply Input	Referenced to PGND, AGND	4.5	5.5	V

Thermal Characteristics

The thermal characteristics were evaluated on a 4-layer pcb structure (1 oz/1 oz/1 oz/1 oz) measuring 7 cm x 7 cm).

Symbol	Parameter	Typ.	Unit
Θ_{JA}	Thermal Resistance, Junction-to-Ambient	35	°C/W
Ψ_{JC}	Thermal Characterization Parameter, Junction-to-Top of Case	2.7	°C/W
Ψ_{JPCB}	Thermal Characterization Parameter, Junction-to-PCB	2.3	°C/W

Electrical Characteristics

Unless otherwise noted; $V_{IN}=12\text{ V}$, $V_{OUT}=1.2\text{ V}$, and $T_A=T_J = -40\text{ to }+125^\circ\text{C}$.⁽⁴⁾

Symbol	Parameter	Condition	Min.	Typ.	Max.	Unit
Supply Current						
$I_{VIN,SD}$	Shutdown Current	EN=0 V			10	μA
$I_{VIN,Q}$	Quiescent Current	EN=5 V, Not Switching			1.8	mA
$I_{VIN,GateCharge}$	Gate Charge Current	EN=5 V, $f_{SW}=500\text{ kHz}$		14		mA
Reference, Feedback Comparator						
V_{FB}	FB Voltage Trip Point		590	596	602	mV
I_{FB}	FB Pin Bias Current		-100	0	100	nA
Modulator						
t_{ON}	On-Time Accuracy	$R_{FREQ}=56.2\text{ k}$, $V_{IN}=10\text{ V}$, $t_{ON}=250\text{ ns}$, No Load	-20		20	%
$t_{ON,PFM}$	PFM On-Time Multiplier			150		%
$t_{OFF,MIN}$	Minimum SW Off-Time			320	374	ns
$t_{ON,MIN}$	Minimum SW On-Time			45		ns
D_{MIN}	Minimum Duty Cycle	FB=1 V		0		%
f_{MINF}	Minimum Frequency Clamp		18.2	25.4	32.7	kHz
Soft-Start						
I_{SS}	Soft-Start Current	SS=0.5 V	7	10	13	μA
$t_{ON,SSMOD}$	SS On-Time Modulation	SS<0.6 V	25		100	%
$V_{SSCLAMP,NOM}$	Nominal Soft-Start Voltage Clamp	$V_{FB}=0.6\text{ V}$		400		mV
$V_{SSCLAMP,OVL}$	Soft-Start Voltage Clamp in Overload Condition	$V_{FB}=0.3\text{ V}$, OC Condition		40		mV
PFM Zero-Crossing Detection Comparator						
V_{OFF}	ZCD Offset Voltage	$T_A=T_J=25^\circ\text{C}$	-6		0	mV
Current Limit						
I_{LIM}	Valley Current Limit Accuracy	$T_A=T_J=25^\circ\text{C}$, $I_{VALLEY}=12\text{ A}$	-10		10	%
$V_{LIM,OFFSET}$	Comparator Offset		-3		3	mV
K_{LIM}	I_{LIM} Set-Point Scale Factor			149		
I_{LIMTC}	Temperature Coefficient			4000		ppm/°C

Continued on the following page...

Electrical Characteristics (Continued)Unless otherwise noted; $V_{IN}=12\text{ V}$, $V_{OUT}=1.2\text{ V}$, and $T_A=T_J = -40\text{ to }+125^\circ\text{C}$. ⁽⁴⁾

Symbol	Parameter	Condition	Min.	Typ.	Max.	Unit
Enable						
V_{TH+}	Rising Threshold				2.0	V
V_{TH-}	Falling Threshold		0.8			V
I_{ENLK}	Enable Pin Leakage	EN=1.2 V			100	nA
I_{ENLK}	Enable Pin Leakage	EN=5 V			76	μA
UVLO						
V_{ON}	V_{CC} Good Threshold Rising				4.4	V
V_{HYS}	Hysteresis Voltage			160		mV
Fault Protection						
V_{UVP}	PGOOD UV Trip Point	On FB Falling	86	89	92	%
V_{VOP1}	PGOOD OV Trip Point	On FB Rising	108	111	115	%
V_{OVP2}	Second OV Trip Point	On FB Rising; LS=On	118	122	125	%
R_{PGOOD}	PGOOD Pull-Down Resistance	$I_{PGOOD}=2\text{ mA}$			125	Ω
$t_{PG,SSDELAY}$	PGOOD Soft-Start Delay		0.82	1.42	2.03	ms
$I_{PG,LEAK}$	PGOOD Leakage Current				1	μA
Thermal Shutdown						
T_{OFF}	Thermal Shutdown Trip Point ^(Error! Reference source not found.)			155		$^\circ\text{C}$
T_{HYS}	Hysteresis ^(Error! Reference source not found.)			15		$^\circ\text{C}$
Internal Bootstrap Diode						
V_{FBOOT}	Forward Voltage	$I_F=10\text{ mA}$			0.6	V
I_R	Reverse Leakage	$V_R=5\text{ V}$			1000	μA

Notes:

- Guaranteed by design; not production tested.
- Device is 100% production tested at $T_A=25^\circ\text{C}$. Limits over that temperature are guaranteed by design.

Typical Performance Characteristics

Tested using evaluation board circuit shown in Figure 1 with $V_{IN}=19\text{ V}$, $V_{OUT}=1.2\text{ V}$, $f_{SW}=500\text{ kHz}$, $T_A=25^\circ\text{C}$, and no airflow; unless otherwise specified.

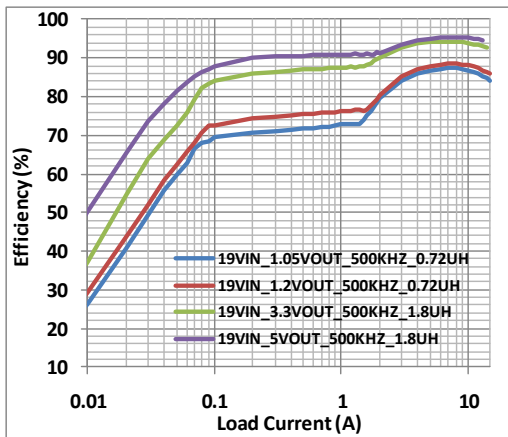

Figure 5. Efficiency vs. Load Current with $V_{IN}=19\text{ V}$ and $f_{SW}=500\text{ kHz}$

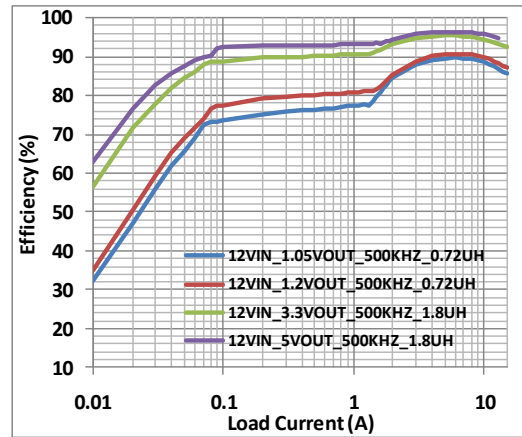

Figure 6. Efficiency vs. Load Current with $V_{IN}=12\text{ V}$ and $f_{SW}=500\text{ kHz}$

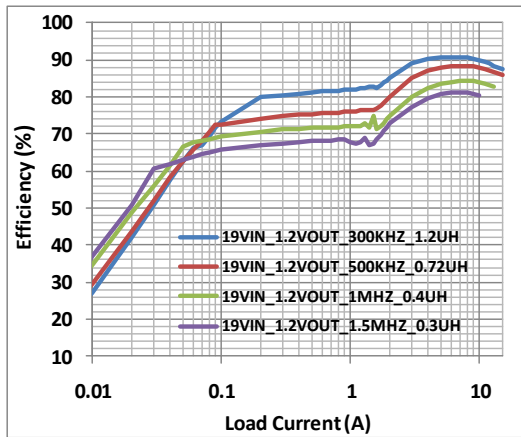

Figure 7. Efficiency vs. Load Current with $V_{IN}=19\text{ V}$ and $V_{OUT}=1.2\text{ V}$

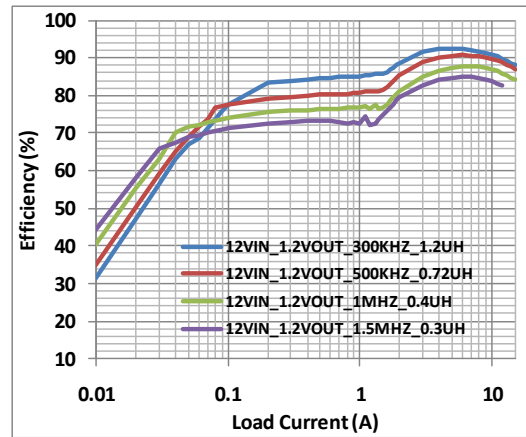

Figure 8. Efficiency vs. Load Current with $V_{IN}=12\text{ V}$ and $V_{OUT}=1.2\text{ V}$

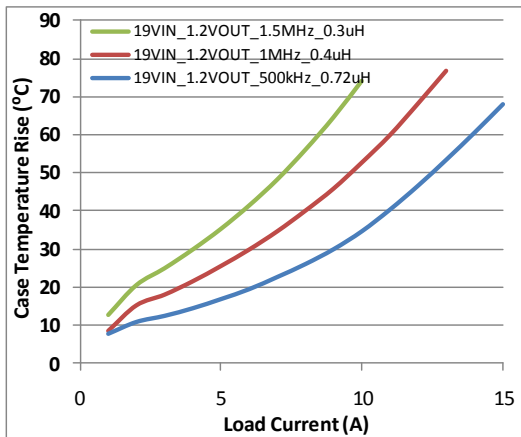

Figure 9. Case Temperature Rise vs. Load Current on 4 Layer PCB, 1 oz Copper, 7 cm x 7 cm

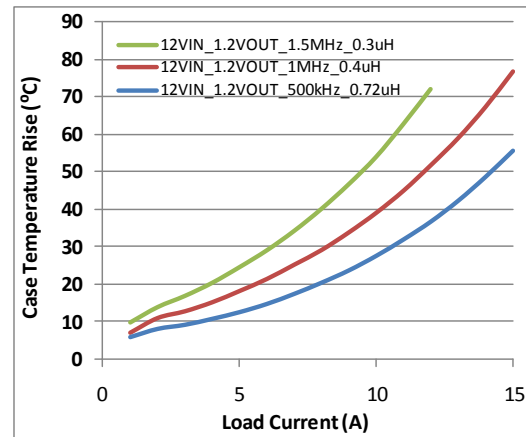

Figure 10. Case Temperature Rise vs. Load Current on 4 Layer PCB, 1 oz Copper, 7 cm x 7 cm

Typical Performance Characteristics

Tested using evaluation board circuit shown in Figure 1 with $V_{IN}=19\text{ V}$, $V_{OUT}=1.2\text{ V}$, $f_{SW}=500\text{ kHz}$, $T_A=25^\circ\text{C}$, and no airflow; unless otherwise specified.

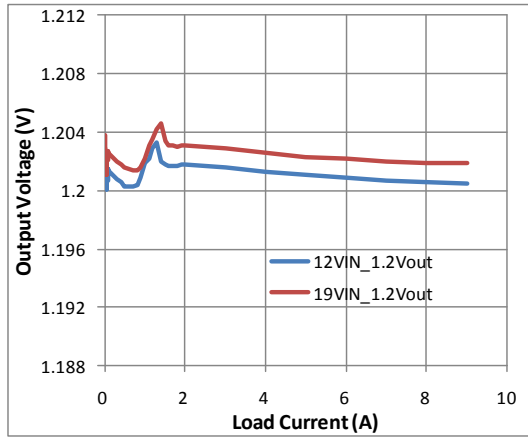

Figure 11. Load Regulation

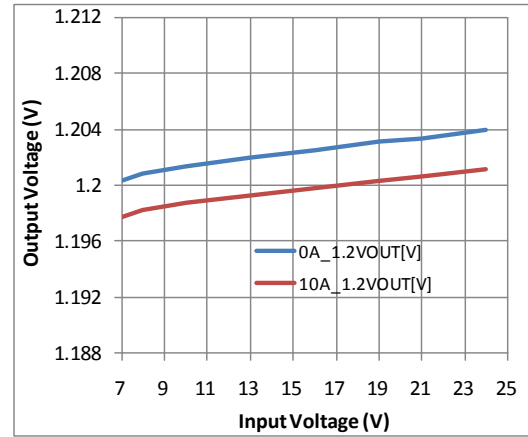

Figure 12. Line Regulation

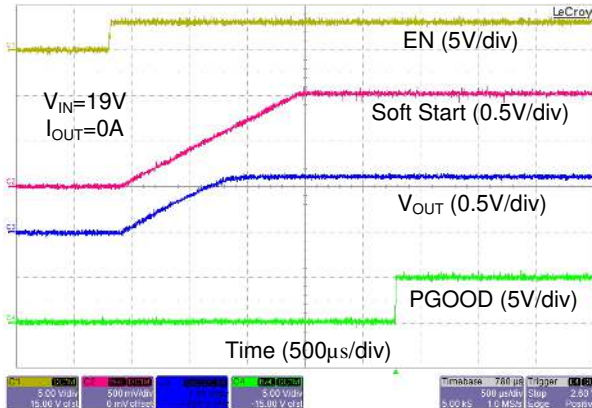

Figure 13. Startup Waveforms with 0 A Load Current

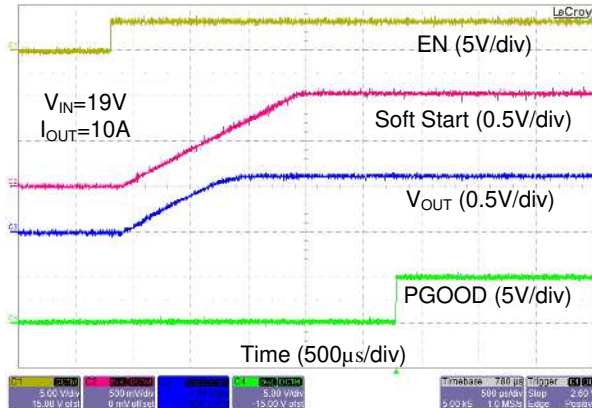

Figure 14. Startup Waveforms with 10 A Load Current

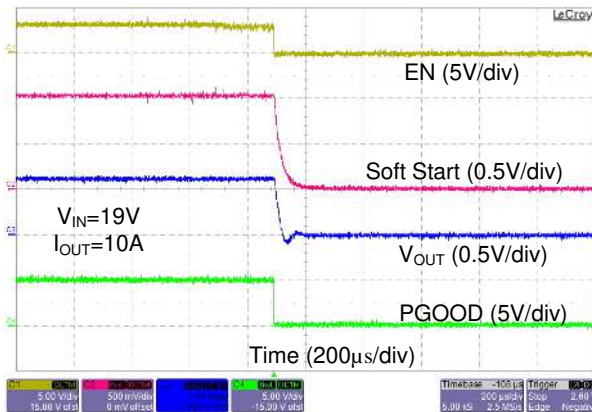

Figure 15. Shutdown Waveforms with 10 A Load Current

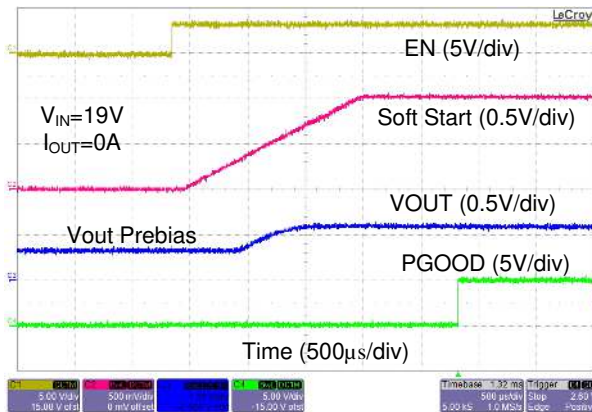

Figure 16. Startup Waveforms with Prebias Voltage on Output

Typical Performance Characteristics

Tested using evaluation board circuit shown in Figure 1 with $V_{IN}=19\text{ V}$, $V_{OUT}=1.2\text{ V}$, $f_{SW}=500\text{ kHz}$, $T_A=25^\circ\text{C}$, and no airflow; unless otherwise specified.

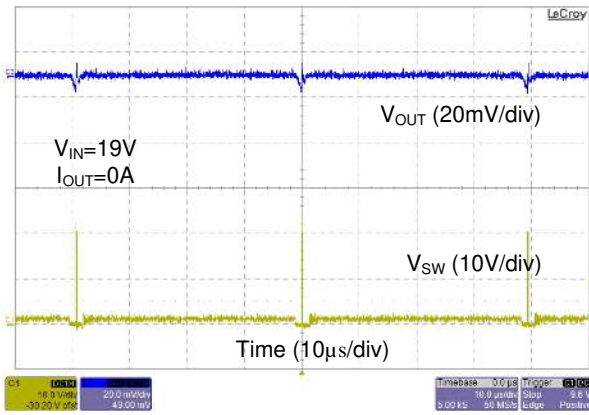

Figure 17. Static Load Ripple at Light Load

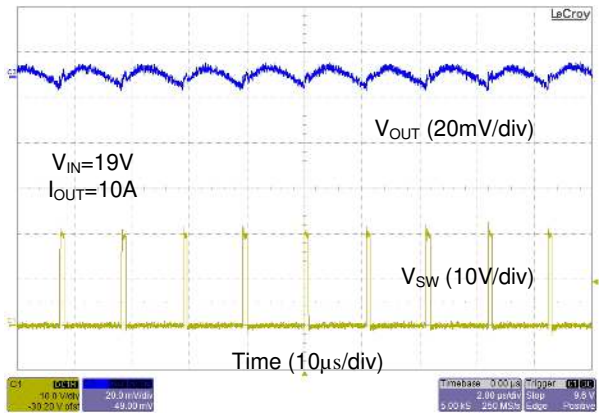

Figure 18. Static Load Ripple at Full Load

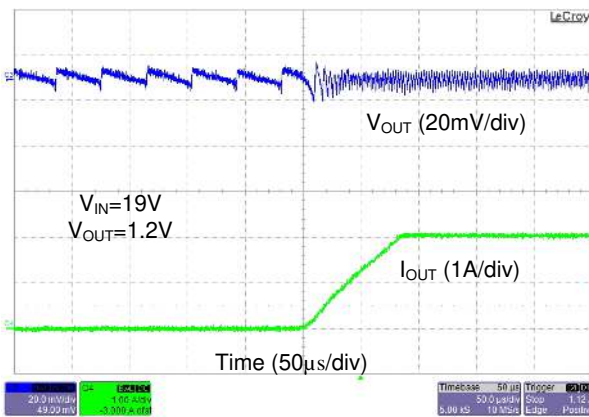

Figure 19. Operation as Load Changes from 0 A to 2 A

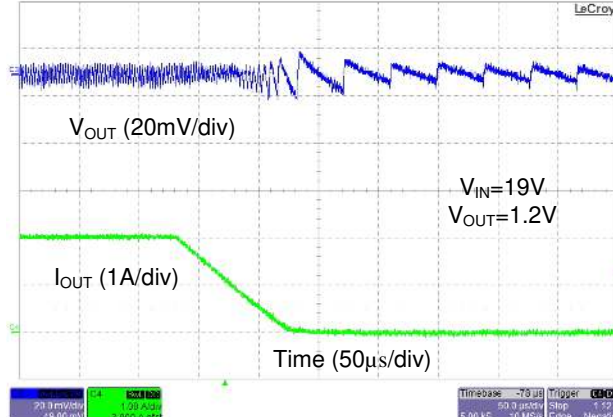

Figure 20. Operation as Load Changes from 2 A to 0 A

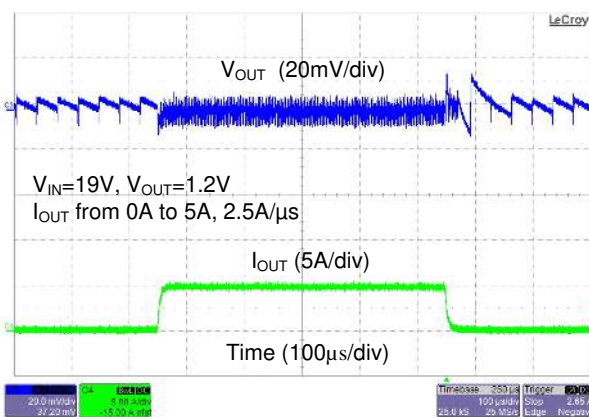

Figure 21. Load Transient from 0% to 50% Load Current

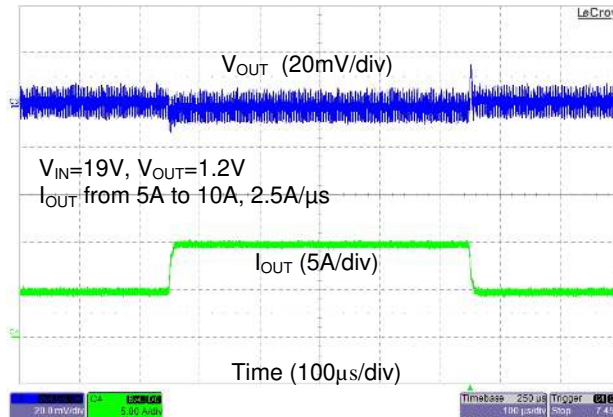

Figure 22. Load Transient from 50% to 100% Load Current

Typical Performance Characteristics

Tested using evaluation board circuit shown in Figure 1 with $V_{IN}=19\text{ V}$, $V_{OUT}=1.2\text{ V}$, $f_{SW}=500\text{ kHz}$, $T_A=25^\circ\text{C}$, and no airflow; unless otherwise specified.

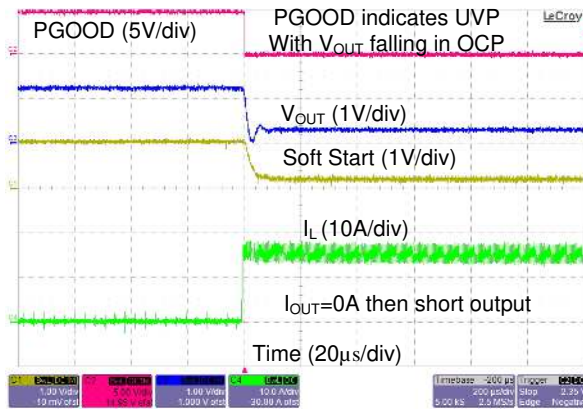

Figure 23. Over-Current Protection with Heavy Load Applied

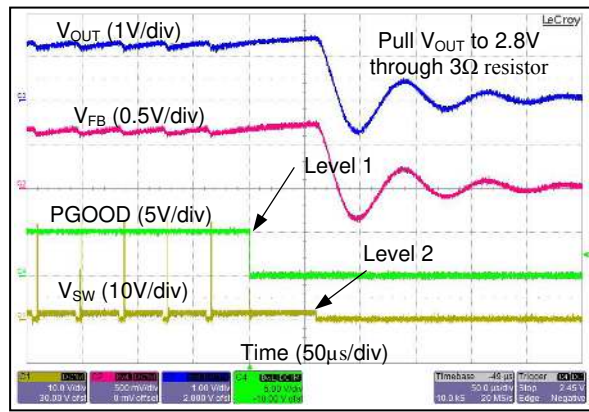

Figure 24. Over-Voltage Protection Level 1 and Level 2

Circuit Operation

The FAN2360 uses a constant on-time modulation architecture with a V_{IN} feed-forward input to accommodate a wide V_{IN} range. This method provides fixed switching frequency (f_{SW}) operation when the inductor operates in Continuous Conduction Mode (CCM) and variable frequency when operating in Pulse Frequency Mode (PFM) at light loads. Additional benefits include excellent line and load transient response, cycle-by-cycle current limiting, and no loop compensation is required.

At the beginning of each cycle, FAN2360 turns on the high-side MOSFET (HS) for a fixed duration (t_{ON}). At the end of t_{ON} , HS turns off for a duration (t_{OFF}) determined by the operating conditions. Once the FB voltage (V_{FB}) falls below the reference voltage (V_{REF}), a new switching cycle begins.

The modulator provides a minimum off-time ($t_{OFF-MIN}$) of 320 ns to provide a guaranteed interval for low-side MOSFET (LS) current sensing and PFM operation. $t_{OFF-MIN}$ is also used to provide stability against multiple pulsing and limits maximum switching frequency during transient events.

Enable

The enable pin is TTL compatible, which supports low-shutdown-current applications, such as notebooks. V_{CC} should be applied after V_{IN} / PV_{IN} is applied to the circuit.

The EN pin can be directly driven by logic voltages of 5 V, 3.3 V, 2.5 V, etc. If the EN pin is driven by 5V logic, a small current flows into the pin when the EN pin voltage exceeds the internal clamp voltage of 4.3 V. To eliminate clamp current flowing into the EN pin use a voltage divider to limit the EN pin voltage to < 4 V.

Constant On-time Modulation

The FAN2360 uses a constant on-time modulation technique, in which the HS MOSFET is turned on for a fixed time, set by the modulator, in response to the input voltage and the frequency setting resistor. This on-time is proportional to the desired output voltage, divided by the input voltage. With this proportionality, the frequency is essentially constant over the load range where inductor current is continuous.

For buck converter in Continuous-Conduction Mode (CCM), the switching frequency f_{SW} is expressed as:

$$f_{SW} = \frac{V_{OUT}}{V_{IN} \cdot t_{ON}} \quad (1)$$

The on-time generator sets the on-time (t_{ON}) for the high-side MOSFET, which results in the switching frequency of the regulator during steady-state operation. To maintain a relatively constant switching frequency over a wide range of input conditions, the input voltage information is fed into the on-time generator.

t_{ON} is determined by:

$$t_{ON} = \frac{C_{tON}}{I_{tON}} \cdot 2V \quad (2)$$

where I_{tON} is:

$$I_{tON} = \frac{1}{10} \cdot \frac{V_{IN}}{R_{FREQ}} \quad (3)$$

where R_{FREQ} is the frequency-setting resistor described in the Setting Switching Frequency section; C_{tON} is the internal 2.2 pF capacitor; and I_{tON} is the V_{IN} feed-forward current that generates the on-time.

The FAN2360 implements open-circuit detection on the FREQ pin to protect the output from an infinitely long on-time. In the event the FREQ pin is left floating, switching of the regulator is disabled. The FAN2360 is designed for V_{IN} input range 4.5 to 24 V, f_{SW} 200 kHz to 1.5 MHz, resulting in an I_{tON} ratio exceeding 1 to 25.

As the ratio of V_{OUT} to V_{IN} increases, $t_{OFF,min}$ introduces a limit on the maximum switching frequency as calculated in the following equation, where the factor 1.2 is included in the denominator to add some headroom for transient operation:

$$f_{SW} < \frac{\left(1 - \frac{V_{OUT}}{V_{IN,min}}\right)}{1.2 \cdot t_{OFF,min}} \quad (4)$$

Soft-Start (SS)

A conventional soft-start ramp is implemented to provide a controlled startup sequence of the output voltage. A current is generated on the SS pin to charge an external capacitor. The lesser of the voltage on the SS pin and the reference voltage is used for output regulation.

To reduce V_{OUT} ripple and achieve a smoother ramp of the output voltage, t_{ON} is modulated during soft-start. t_{ON} starts at 50% of the steady-state on-time (PWM Mode) and ramps up to 100% gradually.

During normal operation, the SS voltage is clamped to 400 mV above the FB voltage. The clamp voltage drops to 40 mV during an overload condition to allow the converter to recover using the soft-start ramp once the overload condition is removed. On-time modulation during SS is disabled when an overload condition exists.

To maintain a monotonic soft-start ramp, the regulator is forced into PFM Mode during soft-start. The minimum frequency clamp is disabled during soft-start.

The nominal startup time is programmable through an internal current source charging the external soft-start capacitor C_{SS} :

$$C_{SS} = \frac{I_{SS} \cdot t_{SS}}{V_{REF}} \quad (5)$$

where:

- C_{SS} = External soft-start programming capacitor;
- I_{SS} = Internal soft-start charging current source, 10 μ A;
- t_{SS} = Soft-start time; and
- V_{REF} = 600 mV

For example; for 1 ms startup time, C_{SS} =15 nF.

The soft-start option can be used for ratiometric tracking.

When EN is LOW, the soft-start capacitor is discharged.

Startup on Pre-Bias

FAN2360 allows the regulator to start on a pre-bias output, V_{OUT} , and ensures V_{OUT} is not discharged during the soft-start operation.

To guarantee no glitches on V_{OUT} at the beginning of the soft-start ramp, the LS is disabled until the first positive-going edge of the PWM signal. The regulator is also forced into PFM Mode during soft-start to ensure the inductor current remains positive, reducing the possibility of discharging the output voltage.

PVCC

The FAN2360 requires an external source connected to PVCC to supply power to the internal gate drivers. The PVCC pin should be bypassed with a 2.2 μ F ceramic capacitor.

V_{CC} Bias Supply and UVLO

The V_{CC} rail supplies power to the controller. It is generally connected to the PVCC rail through a low-pass filter of a 10 Ω resistor and 0.1 μ F capacitor to minimize any noise sources from the driver supply.

An Under-Voltage Lockout (UVLO) circuit monitors the V_{CC} voltage to ensure proper operation. Once the V_{CC} voltage is above the UVLO threshold, the part begins operation after an initialization routine of 50 μ s. There is no UVLO circuitry on either the PVCC or V_{IN} rails.

Pulse Frequency Modulation (PFM)

One of the key benefits of using a constant on-time modulation scheme is the seamless transitions in and out of Pulse Frequency Modulation (PFM) Mode. The PWM signal is not slave to a fixed oscillator and, therefore, can operate at any frequency below the target steady-state frequency. By reducing the frequency during light-load conditions, the efficiency can be significantly improved.

The FAN2360 provides a Zero-Crossing Detector (ZCD) circuit to identify when the current in the inductor reverses direction. To improve efficiency at light load, the LS MOSFET is turned off around the zero crossing to eliminate negative current in the inductor. For predictable operation entering PFM mode the controller waits for nine consecutive zero crossings before allowing the LS MOSFET to turn off.

In PFM Mode, f_{SW} varies or modulates proportionally to the load; as load decreases, f_{SW} also decreases. The switching frequency, while the regulator is operating in PFM, can be expressed as:

$$f_{SW} = \frac{2 \cdot L \cdot I_{OUT}}{t_{ON}^2 \cdot (V_{IN} - V_{OUT})} \cdot \frac{V_{OUT}}{V_{IN}} \quad (6)$$

where L is inductance and I_{OUT} is output load current.

Minimum Frequency Clamp

To maintain a switching frequency above the audible range, the FAN2360 clamps the switching frequency to a

minimum value of 18 kHz. The LS MOSFET is turned on to discharge the output and trigger a new PWM cycle.

Protection Features

The converter output is monitored and protected against over-current, over-voltage, under-voltage, and high-temperature conditions.

Over-Current Protection (OCP)

The FAN2360 uses current information through the LS to implement valley-current limiting. While an OC event is detected, the HS is prevented from turning on and the LS is kept on until the current falls below the user-defined set point. Once the current is below the set point, the HS is allowed to turn on.

During an OC event, the output voltage may droop if the load current is greater than the current the converter is providing. If the output voltage drops below the UV threshold, an overload condition is triggered. During an overload condition, the SS clamp voltage is reduced to 40 mV and the on-time is fixed at the steady-state duration. By nature of the control method; as V_{OUT} drops, the switching frequency is lower due to the reduced rate of inductor current decay during the off-time.

The ILIM pin has an open-detection circuit to provide protection against operation without a current limit.

Under-Voltage Protection (UVP)

If V_{FB} is below the under-voltage threshold of -11% V_{REF} (534 mV), the part enters UVP and PGOOD pulls LOW.

Over-Voltage Protection (OVP)

There are two levels of OV protection: +11% and +22%. During an over-voltage event, PGOOD pulls LOW.

When V_{FB} is > +11% of V_{REF} (666 mV), both HS and LS turn off. By turning off the LS during an OV event, V_{OUT} overshoot can be reduced when there is positive inductor current by increasing the rate of discharge. Once the V_{FB} voltage falls below V_{REF} , the latched OV signal is cleared and operation returns to normal.

A second over-voltage detection is implemented to protect the load from more serious failure. When V_{FB} rises +22% above the V_{REF} (732 mV), the HS turns off, but the LS is forced on until a power cycle on VCC.

Over-Temperature Protection (OTP)

FAN2360 incorporates an over-temperature protection circuit that disables the converter when the die temperature reaches 155°C. The IC restarts when the die temperature falls below 140°C.

Power Good (PGOOD)

The PGOOD pin serves as an indication to the system that the output voltage of the regulator is stable and within regulation. Whenever V_{OUT} is outside the regulation window or the regulator is at over-temperature (UV, OV, and OT), the PGOOD pin is pulled LOW.

PGOOD is an open-drain output that asserts LOW when V_{OUT} is out of regulation or when OT is detected.

Application Information

Stability

Constant on-time stability consists of two parameters: stability criterion and sufficient signal at V_{FB} .

Stability criterion is given by:

$$R_{ESR} \cdot C_{OUT} \gg \frac{t_{ON}}{2} \quad (7)$$

Sufficient signal requirement is given by:

$$\Delta I_{IND} \cdot R_{ESR} > \Delta V_{FB} \quad (8)$$

where ΔI_{IND} is the inductor current ripple and ΔV_{FB} is the ripple voltage on V_{FB} , which should be ≥ 12 mV.

In certain applications, especially designs utilizing only ceramic output capacitors, there may not be sufficient ripple magnitude available on the feedback pin for stable operation. In this case, an external circuit can be added to inject ripple voltage into the FB pin.

There are some specific considerations when selecting the RCC ripple injector circuit. For typical applications, the value of C4 can be selected as 0.1 μ F and approximate values for R2 and C5 can be determined using the following equations.

R2 must be small enough to develop 12 mV of ripple:

$$R2 < \frac{(V_{IN} - V_{OUT}) \cdot V_{OUT}}{V_{IN} \cdot 0.012V \cdot C4 \cdot f_{SW}} \quad (9)$$

R2 must be selected such that the R2C4 time constant enables stable operation:

$$R2 < \frac{0.33 \cdot 2\pi \cdot f_{SW} \cdot L_{OUT} \cdot C_{OUT}}{C4} \quad (10)$$

The minimum value of C5 can be selected to minimize the capacitive component of ripple appearing on the feedback pin:

$$C5_{min} = \frac{L_{OUT} \cdot C_{OUT} \cdot (R3 + R4)}{R2 \cdot R3 \cdot R4 \cdot C4} \quad (11)$$

Using the minimum value of C5 generally offers the best transient response, and 100 pF is a good initial value in many applications. However, under some operating conditions excessive pulse jitter may be observed. To reduce jitter and improve stability, the value of C5 can be increased:

$$C5 \geq 2 \cdot C5_{min} \quad (12)$$

5V PV_{CC}

The PV_{CC} is supplied from an external source to provide power to the drivers and V_{CC}. It is crucial to keep this pin decoupled to PGND with a ≥ 1 μ F X5R or X7R ceramic capacitor. Because V_{CC} powers internal analog circuit, it is filtered from PV_{CC} with a 10 Ω resistor and 0.1 μ F X7R decoupling ceramic capacitor to AGND.

Setting the Output Voltage (V_{OUT})

The output voltage V_{OUT} is regulated by initiating a high-side MOSFET on-time interval when the valley of the divided output voltage appearing at the FB pin reaches V_{REF}. Since this method regulates at the valley of the output ripple voltage, the actual DC output voltage on V_{OUT} is offset from the programmed output voltage by the average value of the output ripple voltage. The initial V_{OUT} setting of the regulator can be programmed from 0.6 V to 5.5 V by an external resistor divider (R3 and R4):

$$R4 = \frac{R3}{\left(\frac{V_{OUT}}{V_{REF}}\right) - 1} \quad (13)$$

where V_{REF} is 600 mV.

For example; for 1.2 V V_{OUT} and 10 k Ω R3, then R4 is 10 k Ω . For 600 mV V_{OUT}, R4 is left open. The final output voltage, including the effect of the output ripple voltage, can be approximated by the equation:

$$V_{OUT} = V_{FB} * \left[1 + \frac{R3}{R4}\right] + \left[\frac{V_{rip}}{2}\right] \quad (14)$$

Setting the Switching Frequency (f_{sw})

f_{sw} is programmed through external R_{FREQ} as follows:

$$R_{FREQ} = \frac{V_{OUT}}{20 * C_{LON} * f_{SW}} \quad (15)$$

where C_{LON}=2.2 pF internal capacitor that generates t_{ON}. For example; for f_{sw}=500 kHz and V_{OUT}=1.2 V, select a standard value for R_{FREQ}=54.9 k Ω .

Inductor Selection

The inductor is typically selected based on the ripple current (ΔI_L), which is approximately 25% to 45% of the maximum DC load. The inductor current rating should be selected such that the saturation and heating current ratings exceed the intended currents encountered in the application over the expected temperature range of operation. Regulators that require fast transient response use smaller inductance and higher current ripple; while regulators that require higher efficiency keep ripple current on the low side.

The inductor value is given by:

$$L = \frac{(V_{IN} - V_{OUT}) \cdot V_{OUT}}{\Delta I_L \cdot f_{SW}} \cdot \frac{V_{OUT}}{V_{IN}} \quad (16)$$

For example: for 19 V V_{IN}, 1.2 V V_{OUT}, 10 A load, 30% ΔI_L , and 500 kHz f_{sw}; L is 720 nH.

Input Capacitor Selection

Input capacitor C_{IN} is selected based on voltage rating, RMS current I_{CIN(RMS)} rating, and capacitance. For capacitors having DC voltage bias derating, such as ceramic capacitors, higher rating is strongly recommended. RMS current rating is given by:

$$I_{CIN(RMS)} = I_{LOAD-MAX} \cdot \sqrt{D \cdot (1 - D)} \quad (17)$$

where $I_{LOAD-MAX}$ is the maximum load current and D is the duty cycle V_{OUT}/V_{IN} . The maximum $I_{CIN(RMS)}$ occurs at 50% duty cycle.

The capacitance is given by:

$$C_{IN} = \frac{I_{LOAD-MAX} \cdot D \cdot (1 - D)}{f_{SW} \cdot \Delta V_{IN}} \quad (18)$$

where ΔV_{IN} is the input voltage ripple, normally 1% of V_{IN} .

For example; for $V_{IN}=19$ V, $\Delta V_{IN}=120$ mV, $V_{OUT}=1.2$ V, 10 A load, and $f_{SW}=500$ kHz; C_{IN} is 9.8 μ F and $I_{CIN(RMS)}$ is 2.4 A_{RMS} . Select a minimum of two 10 μ F 25 V-rated ceramic capacitors with X7R or similar dielectric, recognizing that the capacitor DC bias characteristic indicates that the capacitance value falls approximately 60% at $V_{IN}=19$ V. Also, each 10 μ F can carry over 3 A_{RMS} in the frequency range from 100 kHz to 1 MHz, exceeding the input capacitor current rating requirements. An additional 0.1 μ F capacitor may be needed to suppress noise generated by high frequency switching transitions.

Output Capacitor Selection

Output capacitor C_{OUT} is also selected based on voltage rating, RMS current $I_{COUT(RMS)}$ rating, and capacitance. For capacitors having DC voltage bias derating, such as ceramic capacitors, higher rating is highly recommended.

When calculating C_{OUT} , usually the dominant requirement is the current load step transient. If the unloading transient requirement (I_{OUT} transitioning from HIGH to LOW), is satisfied, then the load transient (I_{OUT} transitioning LOW to HIGH), is also usually satisfied. The unloading C_{OUT} calculation, assuming C_{OUT} has negligible parasitic resistance and inductance in the circuit path, is given by:

$$C_{OUT} = L \cdot \frac{I_{MAX}^2 - I_{MIN}^2}{(V_{OUT} + \Delta V_{OUT})^2 - V_{OUT}^2} \quad (19)$$

where I_{MAX} and I_{MIN} are maximum and minimum load steps, respectively and ΔV_{OUT} is the voltage overshoot, usually specified at 3 to 5%.

For example: for $V_{IN}=12$ V, $V_{OUT}=1.2$ V, 6 A I_{MAX} , 2 A I_{MIN} , $f_{SW}=500$ kHz, $L_{OUT}=720$ nH, and 3% ΔV_{OUT} ripple of 36 mV; the C_{OUT} value is calculated to be 263 μ F. This capacitor requirement can be satisfied using six 47 μ F, 6.3 V-rated X5R ceramic capacitors. This calculation applies for load current slew rates that are faster than the inductor current slew rate, which can be defined as V_{OUT}/L during the load current removal. For reduced-load-current slew rates and/or reduced transient requirements, the output capacitor value may be reduced and comprised of low-cost 22 μ F capacitors.

Setting the Current Limit

Current limit is implemented by sensing the inductor valley current across the LS MOSFET V_{DS} during the LS on-time. The current limit comparator prevents a new on-time from being started until the valley current is less than the current limit.

The set point is configured by connecting a resistor from the ILIM pin to the SW pin. A trimmed current of is output onto the ILIM pin, which creates a voltage across the resistor. When the voltage on ILIM goes negative, an over-current condition is detected.

R_{ILIM} is calculated by:

$$R_{ILIM} = 1.04 \cdot K_{ILIM} \cdot I_{ILIM,VALLEY} \quad (20)$$

where K_{ILIM} is the current source scale factor, and I_{VALLEY} is the inductor valley current when the current limit threshold is reached. The factor 1.04 accounts for the temperature offset of the LS MOSFET compared to the control circuit.

With the constant on-time architecture, HS is always turned on for a fixed on-time; this determines the peak-to-peak inductor current.

Current ripple ΔI is given by:

$$\Delta I_L = \frac{(V_{IN} - V_{OUT}) \cdot t_{ON}}{L} \quad (21)$$

From the equation above, the worst-case ripple occurs during an output short circuit (where V_{OUT} is 0 V). This should be taken into account when selecting the current limit set point.

The FAN2360 uses valley-current sensing, the current limit (I_{ILIM}) set point is the valley (I_{VALLEY}).

The valley current level for calculating R_{ILIM} is given by:

$$I_{VALLEY} = I_{LOAD(CL)} - \frac{\Delta I_L}{2} \quad (22)$$

where $I_{LOAD(CL)}$ is the DC load current when the current limit threshold is reached.

For example: In a converter designed for 10 A steady-state operation and 3 A current ripple, the current-limit threshold could be selected at 120% of $I_{LOAD(MAX)}$ to accommodate transient operation and inductor value decrease under loading. As a result, $I_{LOAD(MAX)}$ is 12 A, $I_{VALLEY}=10.5$ A, and R_{ILIM} is selected as a standard value of 1.62 k Ω .

Boot Resistor

In some applications, especially with higher input voltage, the V_{SW} ring voltage may exceed derating guidelines of 80% to 90% of absolute rating for V_{SW} . In this situation a resistor can be connected in series with boot capacitor (C3 in Figure 1) to reduce the turn-on speed of the high side MOSFET to reduce the amplitude of the V_{SW} ring voltage. If necessary, a resistor and capacitor snubber can be added from V_{SW} to PGND to reduce the magnitude of the ringing voltage. Please contact [Fairchild Customer Support](#) for assistance selecting a boot resistor or snubber circuit in applications that operate above a 21 V typical input voltage.

Printed Circuit Board (PCB) Layout Guidelines

The following points should be considered before beginning a PCB layout using the FAN2360. A sample PCB layout from the evaluation board is shown in Figure 25-Figure 28 following the layout guidelines.

Power components consisting of the input capacitors, output capacitors, inductor, and device should be placed on a common side of the pcb in close proximity to each other and connected using surface copper.

Sensitive analog components including SS, FB, ILIM, FREQ, and EN should be placed away from the high-voltage switching circuits such as SW and BOOT, and connected to their respective pins with short traces.

The inner PCB layer closest to the device should have Power Ground (PGND) under the power processing portion of the device (PVIN, SW, and PGND). This inner PCB layer should have a separate Analog Ground (AGND) under the P1 pad and the associated analog components. AGND and PGND should be connected together near the IC between PGND pins 18-21 and AGND pin 23 which connects to P1 thermal pad.

The AGND thermal pad (P1) should be connected to AGND plane on inner layer using four 0.25 mm vias spread under the pad. No vias are included under PVIN (P2) and SW (P3) to maintain the PGND plane under the power circuitry intact.

Power circuit loops that carry high currents should be arranged to minimize the loop area. Primary focus should be directed to minimize the loop for current flow from the input capacitor to PVIN, through the internal MOSFETs, and returning to the input capacitor. The input capacitor should be placed as close to the PVIN terminals as possible.

The current return path from PGND at the low-side MOSFET source to the negative terminal of the input capacitor can be routed under the inductor and also through vias that connect the input capacitor and low-side MOSFET source to the PGND region under the power portion of the IC.

The SW node trace which connects the source of the high-side MOSFET and the drain of the low-side MOSFET to the inductor should be short and wide.

To control the voltage across the output capacitor, the output voltage divider should be located close to the FB pin, with the upper FB voltage divider resistor connected to the positive side of the output capacitor, and the bottom resistor should be connected to the AGND portion of the device.

When using ceramic capacitor solutions with external ramp injection circuitry (R2, C4, C5 in Figure 1), R2 and C4 should be connected near the inductor, and coupling capacitor C5 should be placed near FB pin to minimize FB pin trace length.

Decoupling capacitors for PVCC and VCC should be located close to their respective device pins.

SW node connections to BOOT, ILIM, and ripple injection resistor R2 should be made through separate traces.

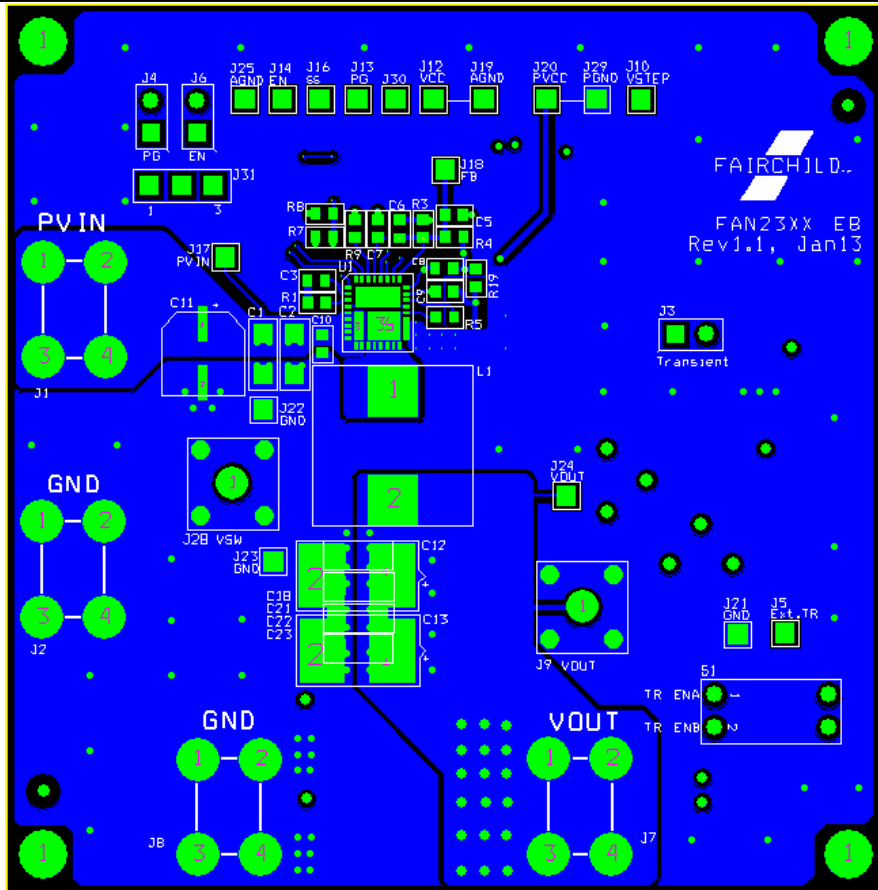

Figure 25. Evaluation Board Top Layer Copper

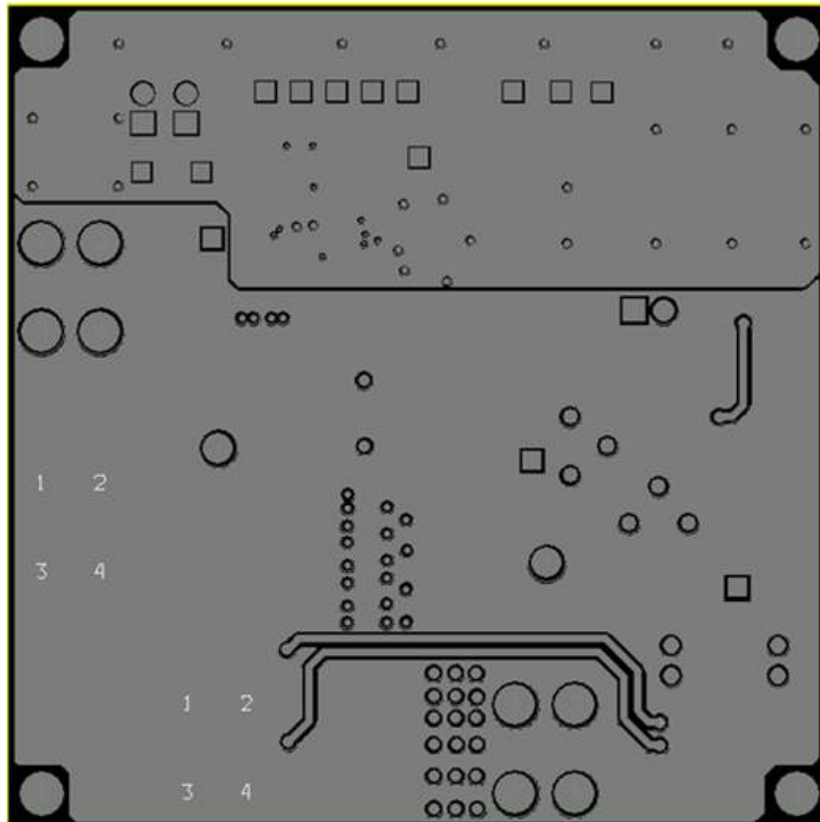

Figure 26. Evaluation Board Inner Layer 1 Copper

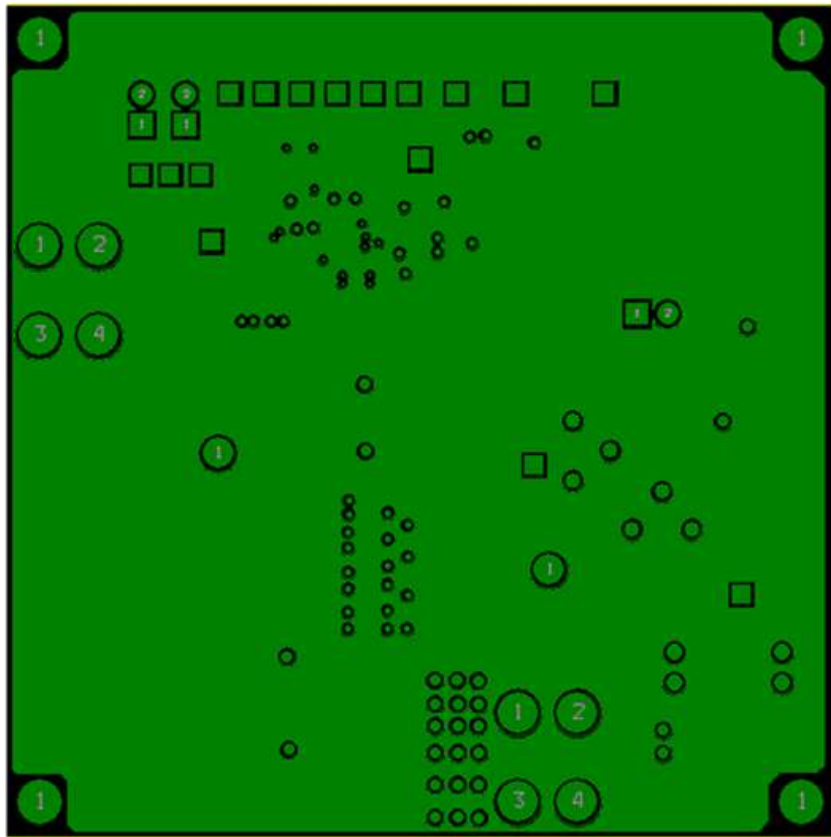

Figure 27. Evaluation Board Inner Layer 2 Copper

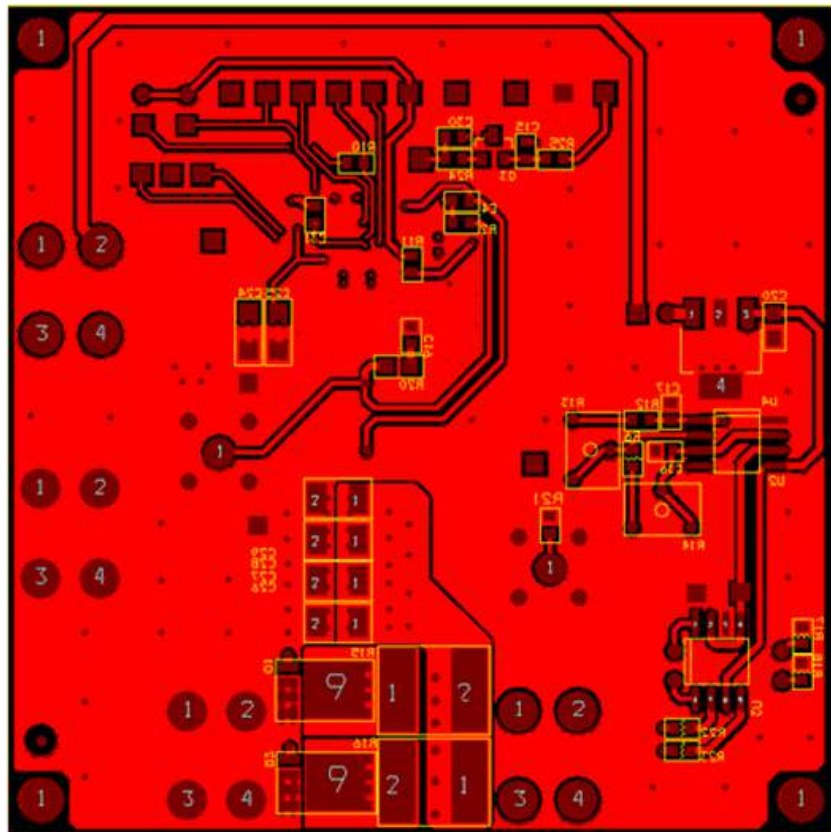
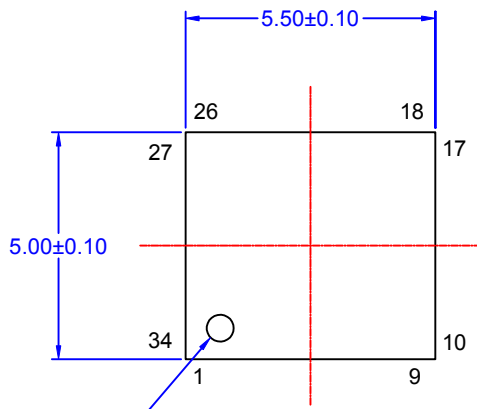
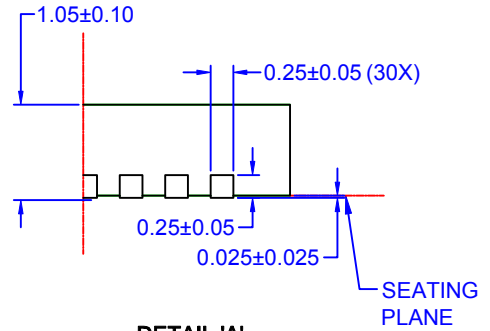

Figure 28. Evaluation Board Bottom Layer Copper



PIN#1
INDICATOR

TOP VIEW



DETAIL 'A'
SCALE: 2:1

SEE
DETAIL 'A'

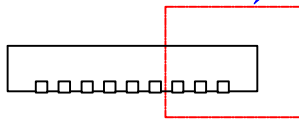

FRONT VIEW

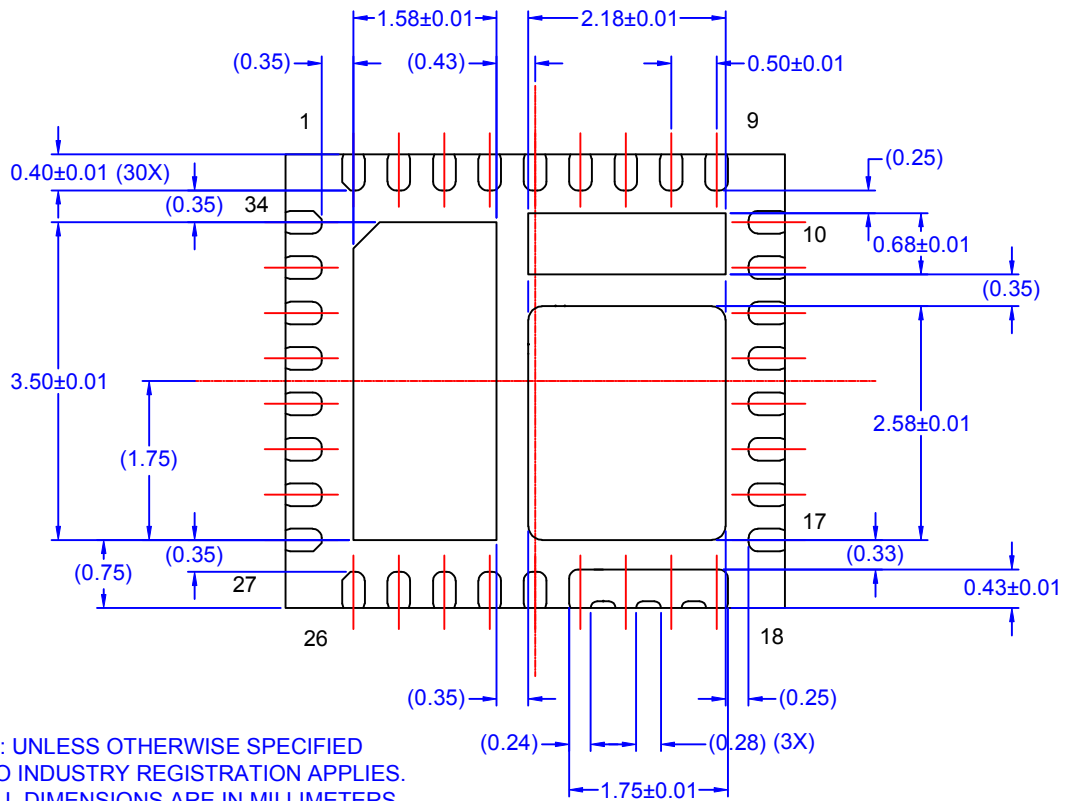

BOTTOM VIEW

- NOTES: UNLESS OTHERWISE SPECIFIED
- A) NO INDUSTRY REGISTRATION APPLIES.
 - B) ALL DIMENSIONS ARE IN MILLIMETERS.
 - C) DIMENSIONS DO NOT INCLUDE BURRS OR MOLD FLASH. MOLD FLASH OR BURRS DOES NOT EXCEED 0.10MM.
 - D) DIMENSIONING AND TOLERANCING PER ASME Y14.5M-2009.
 - E) DRAWING FILE NAME: MKT-PQFN34AREV2
 - F) FAIRCHILD SEMICONDUCTOR

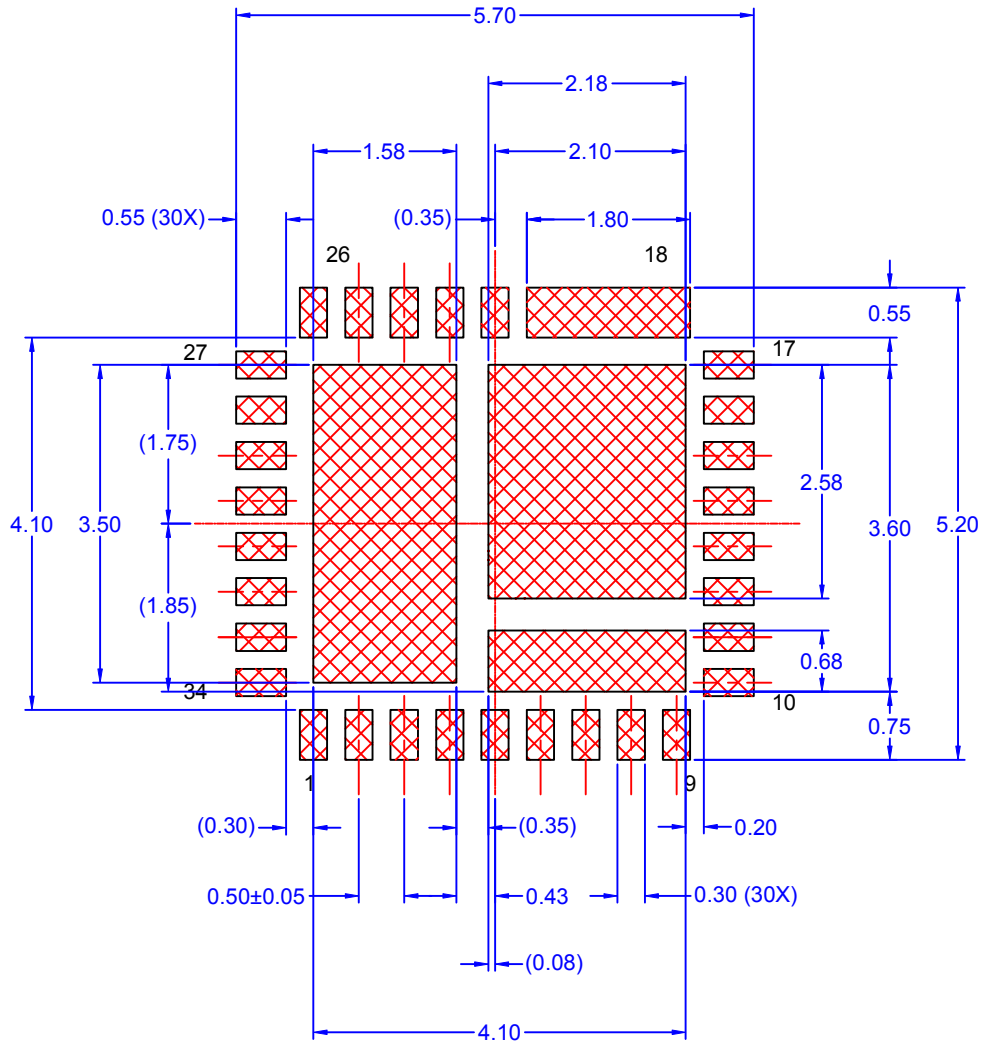

LAND PATTERN
 RECOMMENDATION

ON Semiconductor and  are trademarks of Semiconductor Components Industries, LLC dba ON Semiconductor or its subsidiaries in the United States and/or other countries. ON Semiconductor owns the rights to a number of patents, trademarks, copyrights, trade secrets, and other intellectual property. A listing of ON Semiconductor's product/patent coverage may be accessed at www.onsemi.com/site/pdf/Patent-Marking.pdf. ON Semiconductor reserves the right to make changes without further notice to any products herein. ON Semiconductor makes no warranty, representation or guarantee regarding the suitability of its products for any particular purpose, nor does ON Semiconductor assume any liability arising out of the application or use of any product or circuit, and specifically disclaims any and all liability, including without limitation special, consequential or incidental damages. Buyer is responsible for its products and applications using ON Semiconductor products, including compliance with all laws, regulations and safety requirements or standards, regardless of any support or applications information provided by ON Semiconductor. "Typical" parameters which may be provided in ON Semiconductor data sheets and/or specifications can and do vary in different applications and actual performance may vary over time. All operating parameters, including "Typicals" must be validated for each customer application by customer's technical experts. ON Semiconductor does not convey any license under its patent rights nor the rights of others. ON Semiconductor products are not designed, intended, or authorized for use as a critical component in life support systems or any FDA Class 3 medical devices or medical devices with a same or similar classification in a foreign jurisdiction or any devices intended for implantation in the human body. Should Buyer purchase or use ON Semiconductor products for any such unintended or unauthorized application, Buyer shall indemnify and hold ON Semiconductor and its officers, employees, subsidiaries, affiliates, and distributors harmless against all claims, costs, damages, and expenses, and reasonable attorney fees arising out of, directly or indirectly, any claim of personal injury or death associated with such unintended or unauthorized use, even if such claim alleges that ON Semiconductor was negligent regarding the design or manufacture of the part. ON Semiconductor is an Equal Opportunity/Affirmative Action Employer. This literature is subject to all applicable copyright laws and is not for resale in any manner.

PUBLICATION ORDERING INFORMATION

LITERATURE FULFILLMENT:

Literature Distribution Center for ON Semiconductor
19521 E. 32nd Pkwy, Aurora, Colorado 80011 USA
Phone: 303-675-2175 or 800-344-3860 Toll Free USA/Canada
Fax: 303-675-2176 or 800-344-3867 Toll Free USA/Canada
Email: orderlit@onsemi.com

N. American Technical Support: 800-282-9855 Toll Free
USA/Canada
Europe, Middle East and Africa Technical Support:
Phone: 421 33 790 2910
Japan Customer Focus Center
Phone: 81-3-5817-1050

ON Semiconductor Website: www.onsemi.com
Order Literature: <http://www.onsemi.com/orderlit>
For additional information, please contact your local
Sales Representative