

## **ADS8638EVM-PDK**

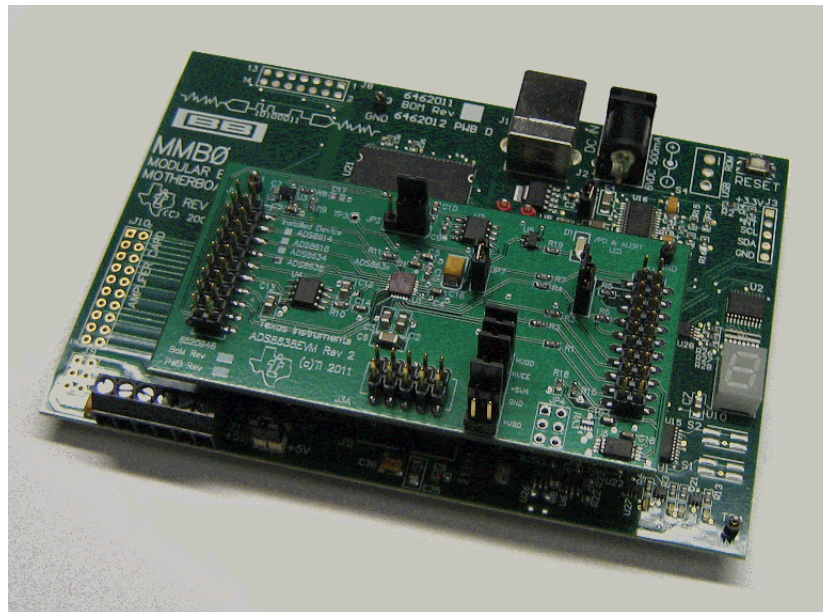

**ADS8638EVM-PDK**

This user's guide describes the characteristics, operation, and use of the [ADS8638EVM](#), both by itself and as a part of the ADS8638EVM-PDK. This evaluation module (EVM) is designed to feature the ADS8638 but can also support the [ADS8614](#), [ADS8618](#), or [ADS8634](#) if installed. This family of devices includes either an 8- or 12-bit, 1-MHz, multi-channel, successive approximation register (SAR) analog-to-digital converters (ADCs). The EVM allows evaluation of all aspects of the ADS8638 device. A complete circuit description as well as schematic diagram and bill of materials are included.

The following related documents are available for download through the Texas Instruments web site at <http://www.ti.com>.

**Table 1. EVM-Related Device Data Sheets**

Device	Literature Number
<a href="#">ADS8638</a>	<a href="#">SBAS541A</a>
<a href="#">OPA140</a>	<a href="#">SBOS498A</a>
<a href="#">OPA379</a>	<a href="#">SBOS347D</a>
<a href="#">REF5025</a>	<a href="#">SBOS410E</a>
<a href="#">SN74LVC1G17D</a>	<a href="#">SCES351R</a>

ADCPro is a trademark of Texas Instruments.  
 Microsoft, Windows are registered trademarks of Microsoft Corporation.  
 SPI is a trademark of Motorola, Inc.  
 All other trademarks are the property of their respective owners.

## Contents

1	EVM Overview .....	3
2	Analog Interface.....	4
3	Digital Interface .....	5
4	Power Supplies .....	5
5	EVM Operation.....	6
6	ADS8638EVM-PDK Kit Operation.....	7
7	Evaluating Performance with the ADCPro Software.....	14
8	EVM Bill of Materials, Schematic, and Layout.....	20

## List of Figures

1	ADS8638EVM Default Jumper Locations .....	7
2	ADS8638EVM-PDK Installer .....	8
3	Completed ADS8638EVM-PDK Installer .....	8
4	MMB0 Initial Setup.....	9
5	Connecting ADS8638EVM to MMB0 .....	10
6	Laboratory Power-Supply Connections .....	11
7	NI-VISA Driver Installation .....	12
8	ADS86xxEVM-PDK Plug-in .....	13
9	Device Configuration.....	15
10	Channels Tabs.....	17
11	GPIOs & Alarms Tab .....	18
12	ADS8638EVM PCB: Top Layer .....	21
13	ADS8638EVM PCB: Mid Layer.....	22
14	ADS8638EVM PCB: Ground Layer .....	22
15	ADS8638EVM PCB: Bottom Layer .....	23

## List of Tables

1	EVM-Related Device Data Sheets .....	1
2	J1: Analog Interface Header .....	4
3	J2: Serial Interface Header .....	5
4	J3: Power-Supply Interface Header .....	5
5	JP3 Configuration: Power Options .....	6
6	Bill of Materials .....	20

## 1 EVM Overview

### 1.1 Features

#### ADS8638EVM:

- Full-featured evaluation board for the [ADS8638](#) SAR ADC
- Contains all support circuitry needed for the ADS8638
- Optional onboard external REF5025 reference source
- Compatible with the TI Modular EVM System

#### ADS8638EVM-PDK:

- Easy-to-use evaluation software for Microsoft® Windows® XP operating system
- Data collection to text files
- Built-in analysis tools including scope, FFT, and histogram displays
- Complete control of board settings
- Easily expandable with new analysis plug-in tools from Texas Instruments

For use with a computer, the ADS8638EVM-PDK is also available. This kit combines the ADS8638 board with the DSP-based MMB0 motherboard, and includes [ADCPro™ software](#) for evaluation.

The MMB0 motherboard allows the ADS8638EVM to be connected to the computer via an available USB port. This manual shows how to use the MMB0 as part of the ADS8638EVM-PDK, but does not provide technical details about the MMB0 itself.

ADCPro is a program for collecting, recording, and analyzing data from ADC evaluation boards. It is based on a number of plug-in programs, so it can be expanded easily with new test and data collection plug-ins. The ADS8638EVM-PDK is controlled by a plug-in running in ADCPro. For more information about ADCPro, see the [ADCPro™ Analog-to-Digital Converter Evaluation Software User's Guide](#) (literature number [SBAU128](#)), available for download from the TI web site.

This manual covers the operation of both the ADS8638EVM and the ADS8638EVM-PDK. Throughout this document, the abbreviation *EVM* and the term *evaluation module* are synonymous with the ADS8638EVM. For clarity of reading, the rest of this manual will refer only to the ADS8638EVM or ADS8638EVM-PDK, but operation of the EVM and kit for the ADS8614, ADS8618, and ADS8634 is identical, unless otherwise noted.

### 1.2 Introduction

The ADS8638 is a 12-bit, eight-channel, 1-MHz SAR ADC with a serial peripheral interface (SPI™). The ADC uses a capacitor-based switching method to create an adjustable input voltage range option. Additionally, the device features two preset alarms with hysteresis per channel. During normal operation, the ADS8638 dissipates a mere 22.5 mW at 5-V AVDD and ±15-V high voltage supplies.

The ADS8638EVM is an evaluation module built to the TI Modular EVM System specification. It can be connected to any modular EVM system interface card.

The ADS8638EVM is available as a stand-alone printed circuit board (PCB) or as part of the ADS8638EVM-PDK, which includes an MMB0 motherboard and software. As a stand-alone PCB, the ADS8638EVM is useful for evaluating designs and firmware.

Note that the ADS8638EVM has no microprocessor and cannot run software. To connect it to a computer, some type of interface is required.

## 2 Analog Interface

For maximum flexibility, the ADS8638EVM is designed for easy interfacing to multiple analog sources. Samtec part numbers SSW-110-22-F-D-VS-K and TSM-110-01-T-DV-P provide a convenient 10-pin, dual row header/socket combination at J1. This header/socket provides access to the analog input pins of the ADC. Consult Samtec at [www.samtec.com](http://www.samtec.com) or call 1-800-SAMTEC-9 for a variety of mating connector options. Table 2 shows the pinout of the analog input connector, J1.

**Table 2. J1: Analog Interface Header**

Pin Number	Signal	Description
J1.2	AIN7 / NC	ADC analog input (AIN7: ADS8x38, NC: ADS8x34)
J1.4	AIN6 / NC	ADC analog input (AIN6: ADS8x38, NC: ADS8x34)
J1.6	AIN5 / AIN3	ADC analog input (AIN5: ADS8x38, AIN3: ADS8x34)
J1.8	AIN4 / AIN2	ADC analog input (AIN4: ADS8x38, AIN2: ADS8x34)
J1.10	AIN3 / AIN1	ADC analog input (AIN3: ADS8x38, AIN1: ADS8x34)
J1.12	AIN2 / AIN0	ADC analog input (AIN2: ADS8x38, AIN0: ADS8x34)
J1.14	AIN1 / NC	ADC analog input (AIN1: ADS8x38, NC: ADS8x34)
J1.16	AIN0 / NC	ADC analog input (AIN0: ADS8x38, NC: ADS8x34)
J1.1-19 (odd)	GND	Analog ground connections (except J1.15)
J1.15	V <sub>REFOUT</sub>	Buffered reference output
J1.18	NC	—
J1.20	Ext V <sub>REF</sub>	External reference voltage input

The eight ADC analog inputs (four inputs for ADS8x34 devices) are available at the J1 header. All of these inputs, with the exception of one, are routed directly from the J1 header to the ADC. The AIN2/AIN0 channel includes an [OPA140](#) to help drive one of the analog input channels to show the proper way to drive the ADC. The op amp is in unity gain, and includes a RC low-pass filter component before reaching the ADC.

An external reference can be applied to the ADC via an external source using pin J1.20. This signal is routed directly to JP2 where it can be jumped in to the VREFP line.

An [OPA379](#) is located on the EVM to buffer the reference signal and output it on J1.15.

## 3 Digital Interface

### 3.1 Serial Data Interface

Samtec part numbers SSW-110-22-F-D-VS-K and TSM-110-01-T-DV-P provide a convenient 10-pin, dual row header/socket combination at J2. This header/socket provides access to the digital control pins of the EVM. Consult Samtec at [www.samtec.com](http://www.samtec.com) or 1-800-SAMTEC- 9 for a variety of mating connector options.

Table 3 describes the J2 serial interface pins.

**Table 3. J2: Serial Interface Header**

Pin Number	Signal	Description
J2.1	$\overline{CS}$	ADC $\overline{CS}$ signal: controlled by jumper JP1
J2.2	GPIO	ADC $\overline{PD}$ / Alert signal
J2.3	SCLK	ADC SCLK signal
J2.4	GND	Digital ground
J2.5	SCLK	ADC SCLK signal
J2.7	$\overline{CS}$	ADC $\overline{CS}$ signal: controlled by jumper JP1
J2.9	$\overline{CS}$	ADC $\overline{CS}$ signal: controlled by jumper JP1
J2.10	GND	Digital ground
J2.11	SDI	ADC SDI signal
J2.13	SDO	ADC SDO signal
J2.16	SCL	I <sup>2</sup> C clock line for EEPROM
J2.18	GND	Digital ground
J2.20	SDA	I <sup>2</sup> C data line for EEPROM

## 4 Power Supplies

J3 is the power-supply input connector. Table 4 lists the configuration details for J3.

**Table 4. J3: Power-Supply Interface Header**

Pin Number	Pin Name	Function	Required
J3.1	+VA	High voltage positive analog supply	Yes
J3.2	-VA	High voltage negative analog supply	Yes
J3.3	+5VA	5-V analog supply	Yes
J3.4	-5VA	Unused	No
J3.5	GND	Digital ground input	Yes
J3.6	GND	Analog ground input	Yes
J3.7	+1.8VD	1.8-V digital supply	Yes/Optional
J3.8	VD1	Unused	No
J3.9	+3.3VD	3.3-V digital supply	Yes/Optional
J3.10	+5VD	Unused	Yes/Optional

## 4.1 Power Options

JP3 is in place for current measurement in order to regulate the power consumption of the ADS8638. When current measurement is not taking place, jumpers must be applied across many of the jumpers to properly power the ADC. [Table 5](#) lists the power option details for JP3.

**Table 5. JP3 Configuration: Power Options**

Row	Name	Function
1-2	ADC HVDD	Supply current measurement point for high voltage positive rail. Must be connected for operation.
3-4	ADC HVEE	Supply current measurement point for high voltage negative rail. Must be connected for operation.
5-6	ADC +5 VA	Supply current measurement point for +5-VA voltage rail. Must be connected for operation.
7-8	GND	Ground points for EVM board
9-10	ADC +3.3 VD	Supply current measurement point for 3.3-V digital supply rail. Must be connected for ADC use with DVDD = 3.3 V. Do not connect if +5-VD jumper is installed.
11-12	ADC +1.8 VD	Supply current measurement point for 1.8V digital supply rail. Must be connected for ADC use with DVDD = 1.8 V. Do not connect if +3.3-VD jumper is installed.

The ADS8638EVM has the option to either set +1.8 VD or +3.3 VD as the ADS8638 DVDD supply. Install a jumper across pins 9-10 to set DVDD = 3.3 V, or install a jumper across pins 11-12 to set DVDD = 1.8 V.

### CAUTION

Do not install both jumpers. Doing so may cause damage to the board or ADC device itself.

## 4.2 Reference Voltages

The ADS8638EVM can be configured to use the internal reference voltage found within the chip, an onboard REF5025 reference source, or use the option to input an external reference source. Jumper JP2 is used to route the reference signal to the ADC. When placed in the 1-2 position, the onboard REF5025 is used as the reference signal. When placed in the 2-3 position, an outside external reference can be applied to J1.20 on the analog header to feed the ADC reference. If the ADC internal reference is enabled, the shunt on jumper JP2 must be either in the 2-3 position or left disconnected. This configuration ensures that the REF5025 source is not driving the ADS8638 reference pin when the pin is configured as an output.

## 5 EVM Operation

This section provides information on the analog input, digital control, and general operating conditions of the ADS8638EVM.

### 5.1 Analog Input

Each of the analog input sources can be applied directly to J1 (top or bottom side) or through signal-conditioning modules available for the modular EVM system.

## 5.2 Digital Control

The digital control signals can be applied directly to J2 (top or bottom side). The modular ADS8638EVM can also be connected directly to a DSP or microcontroller interface board, such as the [5-6K Interface](#) or [HPA-MCU Interface](#) boards available from Texas Instruments, or the MMB0 if purchased as part of the ADS8638EVM-PDK. For a list of compatible interface and/or accessory boards for the EVM or the ADS8638, see the relevant device product folder on the TI web site

## 5.3 Default Jumper Settings and Switch Positions

Figure 1 shows the jumpers found on the EVM and the respective factory default conditions for each.

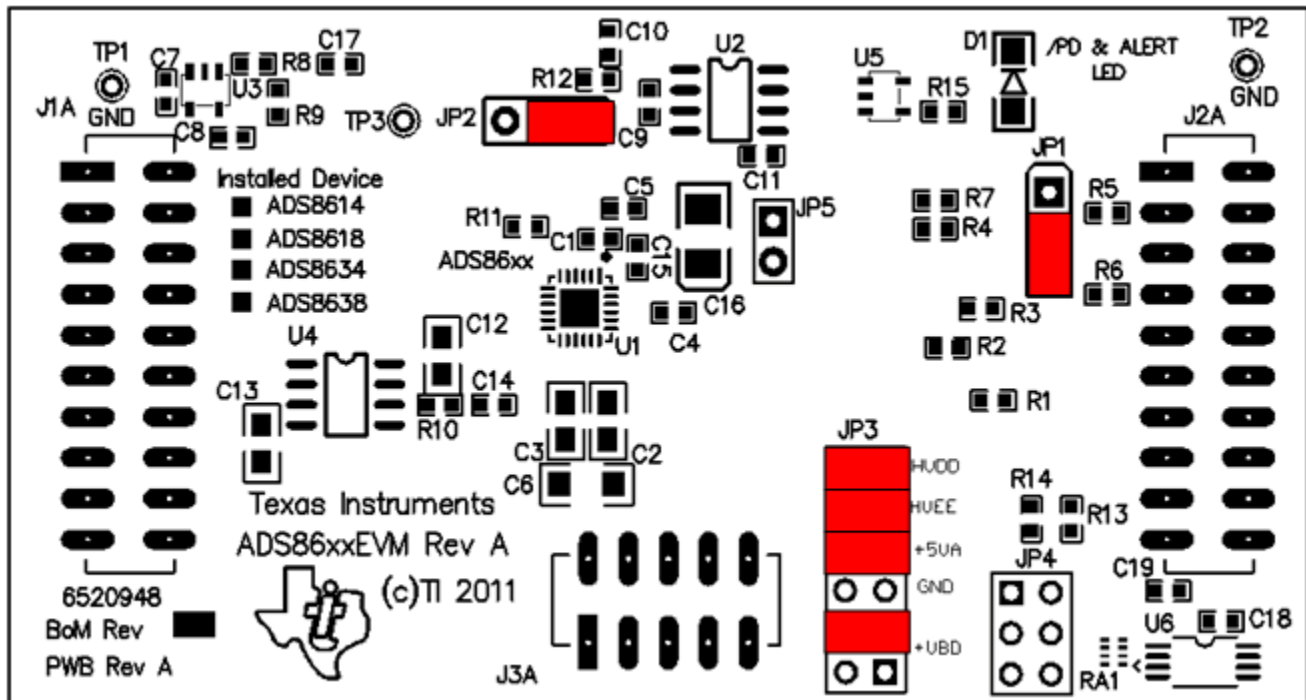

Figure 1. ADS8638EVM Default Jumper Locations

## 6 ADS8638EVM-PDK Kit Operation

This section provides information on the analog input, digital control, and general operating conditions of the ADS8638EVM.

### 6.1 Installing ADCPro Software

The latest software is available from the TI website at <http://www.ti.com>. Any updates to the ADCPro software can also be downloaded directly from the TI web site (<http://www.ti.com/adcpro>) or the update check command can be used. Refer to the [ADCPro User Guide](#) for instructions on installing and using ADCPro.

To install the ADS8638EVM-PDK plug-in, run the file: **ads86xx-adcproplugin-1.2.3.exe** (1.2.3 is the version number, and increments with software version releases). Double-click the file to run it; then follow the instructions shown. You can also use the ADCPro Update Check feature to check for newer versions of the ADS8638EVM-PDK plug-in, once you have installed a version of it.

Figure 2 and Figure 3 show a set of installation screens to pass through as the ADS86xxEVM-PDK plug-in is installed.

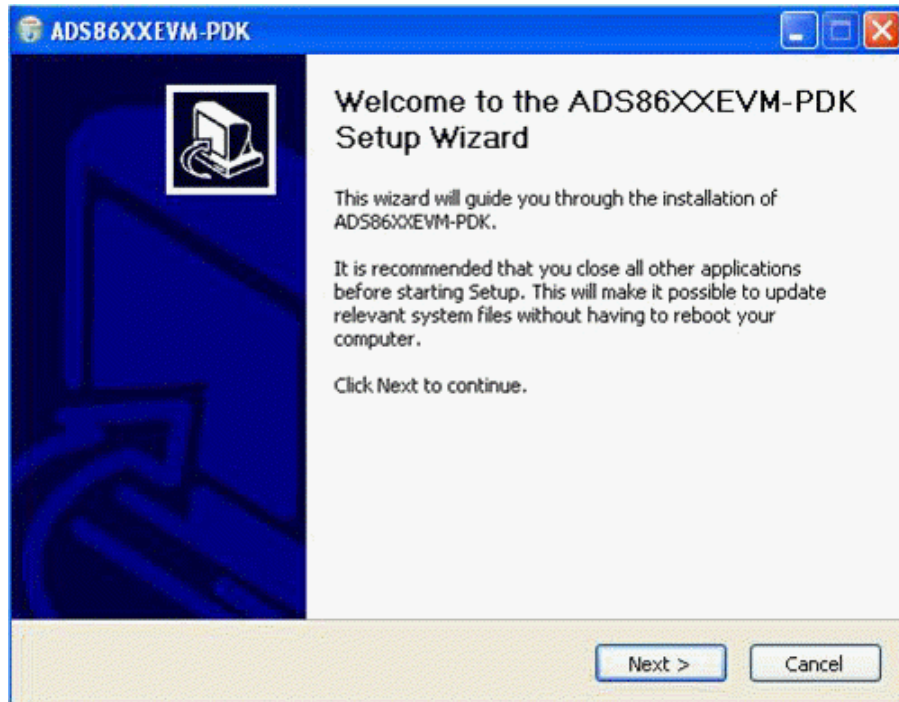

Figure 2. ADS8638EVM-PDK Installer

Continue through the pop-up screens until the plug-in is completely installed.

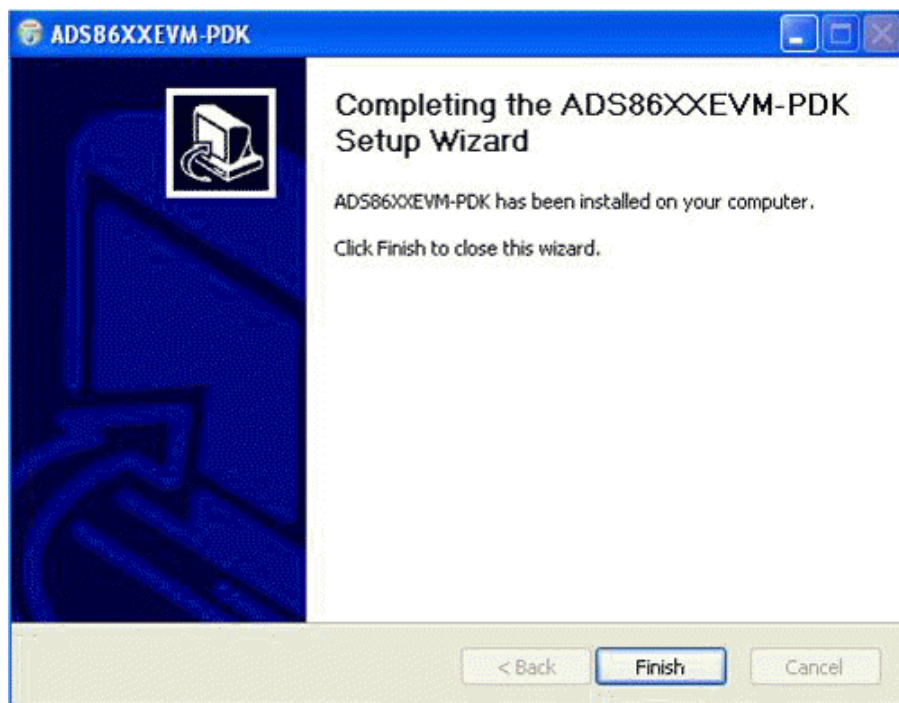

Figure 3. Completed ADS8638EVM-PDK Installer



## 6.2 Setting Up the ADS8638EVM-PDK

The ADS8638EVM-PDK contains both the ADS8638EVM and the MMB0 motherboard; however, the devices are shipped unconnected. Follow these steps to set up the ADS8638EVM-PDK.

- Step 1. Unpack the ADS8638EVM-PDK kit.
- Step 2. Set the jumpers and switches on the MMB0 as shown in [Figure 4](#).
  - Set the Boot Mode switch to USB.
  - Connect +5 V and +5 VA on jumper block J13B (if +5 V is supplied from J14 +5 VA).
  - Leave +5 V and +VA disconnected on jumper block J13A.
  - If the PDK is powered using the included CA-2186 cable, connect J12. If the PDK is powered through the terminal block, disconnect J12. (See [Section 6.3](#) for details on connecting the power supply.)

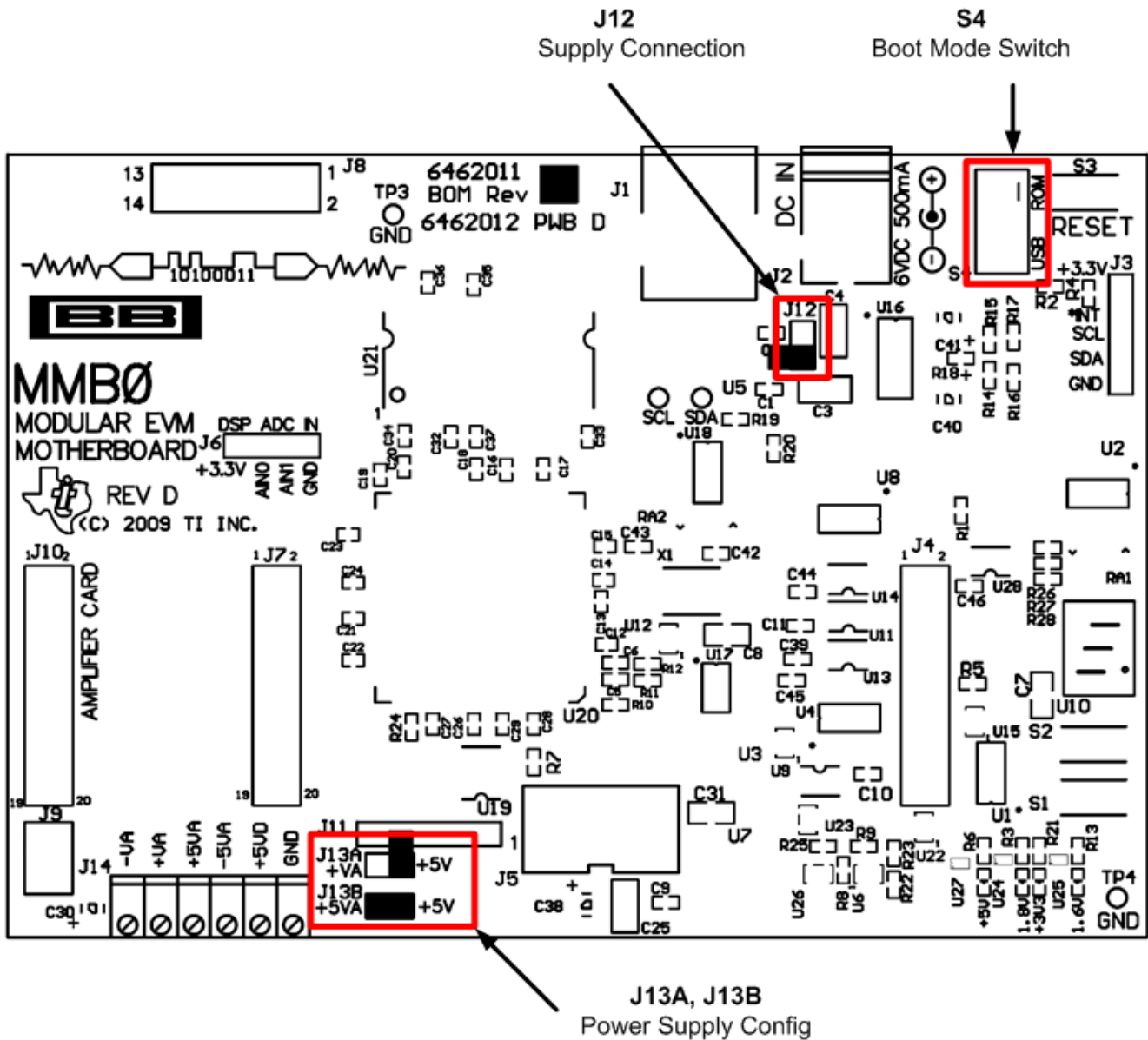
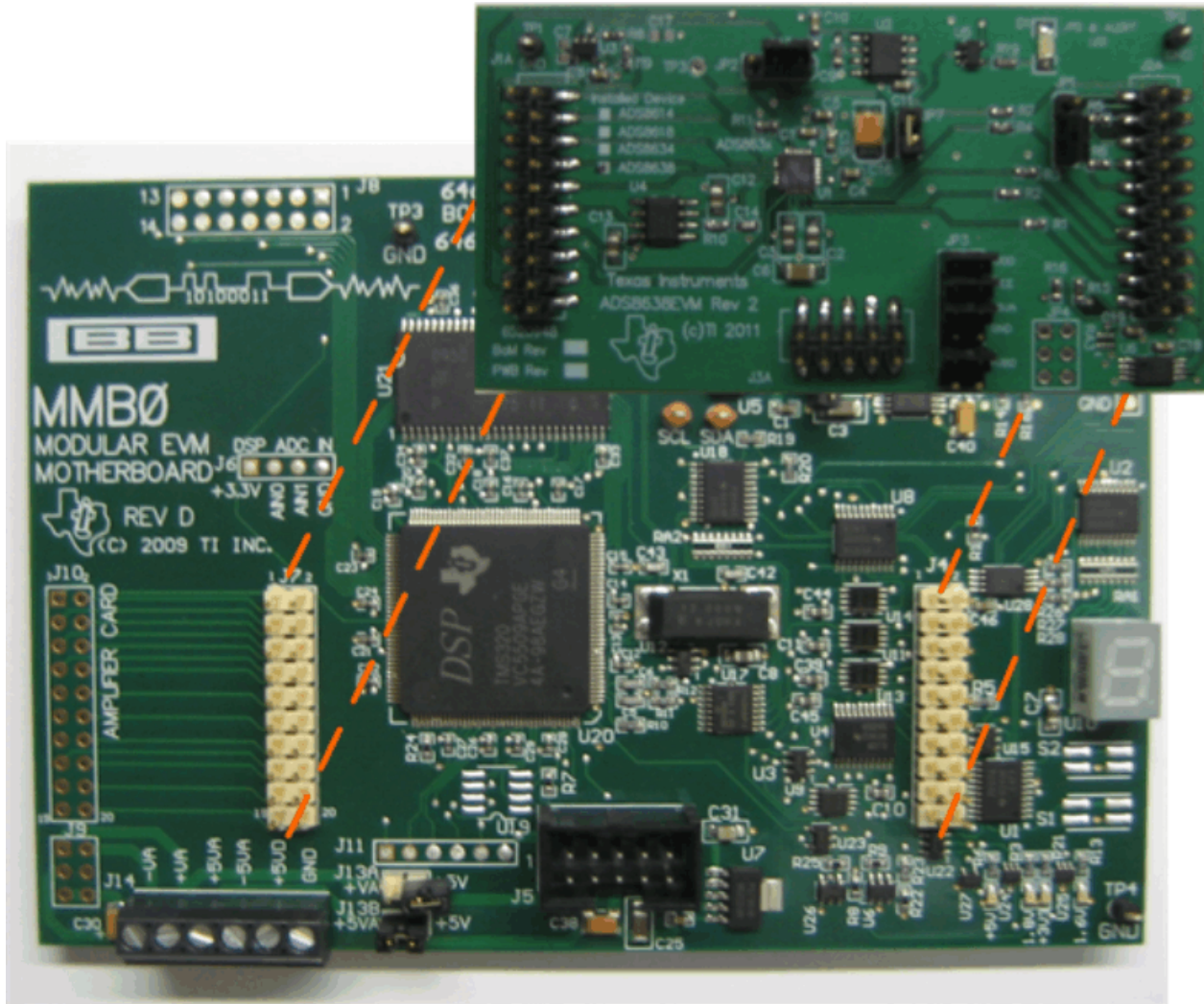

Figure 4. MMB0 Initial Setup

Step 3. Plug the ADS8638EVM into the MMB0 as [Figure 5](#) illustrates.



**Figure 5. Connecting ADS8638EVM to MMB0**

Step 4. Set the jumpers on the ADS8638EVM as shown in [Figure 1](#) (note that these settings are the factory-configured default settings for the EVM).

### 6.2.1 About the MMB0

The MMB0 is a Modular EVM System motherboard. It is designed around the [TMS320VC5507](#), a DSP with an onboard USB interface from Texas Instruments. The MMB0 also has 16 MB of SDRAM installed.

The MMB0 is not sold as a DSP development board, and it is not available separately. TI cannot offer support for the MMB0 except as part of an EVM kit. For schematics or other information about the MMB0, contact Texas Instruments.

### 6.3 Connecting the Power Supply

The ADS8638EVM-PDK requires multiple supplies to power the ADC to be used with the MMB0 motherboard. The ADS8638 requires two high-voltage supplies ( $\pm 10$  V to  $\pm 15$  V), HVDD and HVVEE, along with a +5-V supply to power the analog, AVDD, and +3.3 V to +5 V to power the digital circuitry, DVDD.

When the MMB0 DSP is powered properly, LED D2 glows green. The green light indicates that the 3.3-V supply for the MMB0 is operating properly. (It does **not** indicate that the EVM power supplies are operating properly.)

#### 6.3.1 Connecting the Laboratory Power Supply

A laboratory power supply can be connected through terminal block J14 on the MMB0, as shown in Figure 6. To use a unipolar lab power supply configuration, follow these procedures:

- Disconnect J12 on the MMB0.
- Connect a +5-V dc supply to the +5 VD terminal on J14.
- Connect ground of the dc supply to the GND terminal on J14.

For bipolar mode, also connect a  $-10$ -V dc supply to the  $-VA$ , and +10 V on the +VA terminals on J14.

It is not necessary to connect a +5-V dc supply voltage to the +5 VA terminal on J14 if the +5 V/+5 VA position on J13 is shorted.

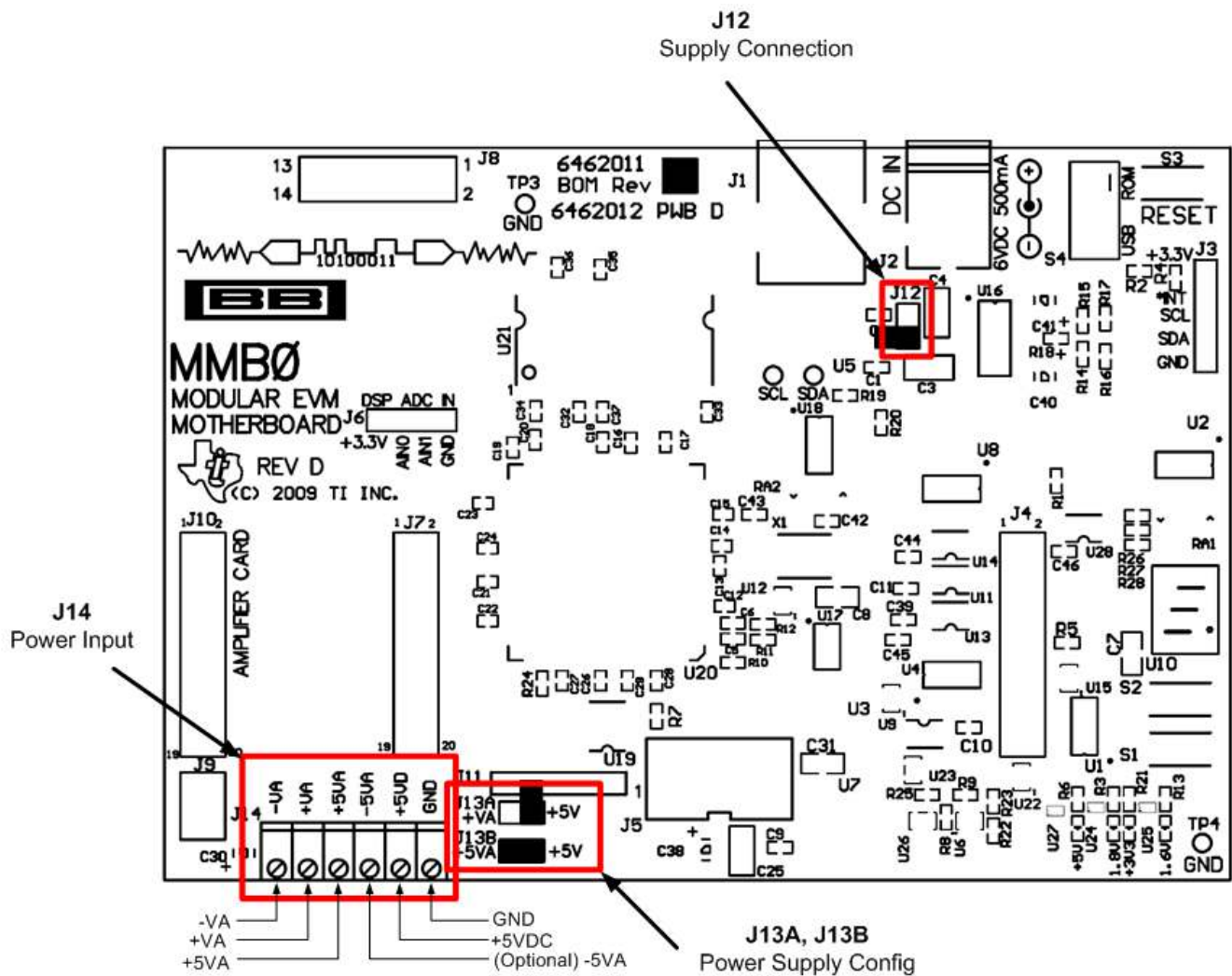

Figure 6. Laboratory Power-Supply Connections

## 6.4 Running the Software and Completing Driver Installation

**NOTE:** The software is continually under development. These instructions and screen images are current at the time of this writing, but may not exactly match future releases.

The program for evaluating the ADS8638EVM-PDK is called ADCPro. This program uses plug-ins to communicate with the EVM. The ADS8638EVM-PDK plug-in is included in the ADS8638EVM-PDK package.

The program currently runs only on Microsoft Windows platforms of Windows XP; plans are in place to have ADCPro working on Windows 7 in the near future.

If this is the first time installing ADCPro and any related plug-ins, follow these procedures to run the ADCPro software and complete the necessary driver installation. Make sure the ADCPro software and device plug-in software are the latest versions available online at [www.ti.com/ADCPro](http://www.ti.com/ADCPro).

### 6.4.1 NI-VISA USB Device Driver Installation

1. After the ADCPro software is installed, apply power to the PDK and connect the board to an available PC USB port.
2. The computer should recognize the new hardware and begin installing the drivers for the hardware. [Figure 7](#) is provided for reference to show the installation steps. To simplify installation, accept the default settings.



Figure 7. NI-VISA Driver Installation

### 6.4.2 USBStyx Driver Installation

1. Start the software by selecting ADCPro from the Windows Start menu.
2. Select *ADS86xxEVM* from the EVM drop-down menu. The ADS86xxEVM-PDK plug-in appears in the left pane. The setup is shown in [Figure 8](#).

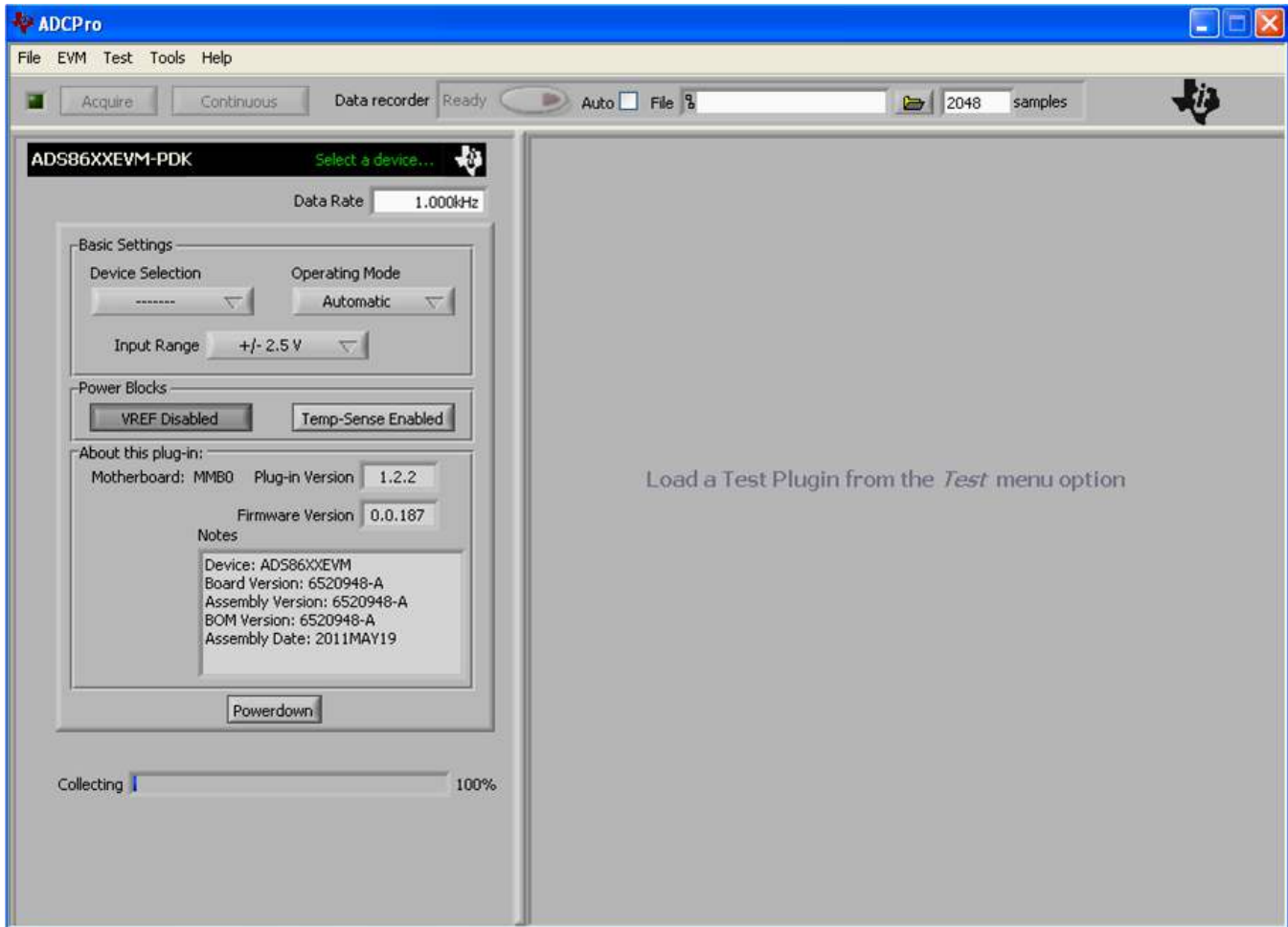

**Figure 8. ADS86xxEVM-PDK Plug-in**

3. The ADS86xxEVM-PDK plug-in window has a status area at the top of the screen. When the plug-in is first loaded, the plug-in searches for the board. A series of messages will appear in the status area to indicate this action.
4. If you have not yet loaded the operating system drivers, Windows displays the *Install New Driver Wizard* sequence; accept the default settings.

---

**NOTE:** During the driver installation process, a message may appear that indicates the firmware load has timed out. Click **OK** and continue driver installation. The plug-in will attempt to download the firmware again once the driver installation completes.

---

5. Once Windows finishes installing the software driver, the plug-in downloads the firmware to the MMB0. The status area displays *Connected to EVM* when the device is connected and ready to use. If the firmware does not load properly, you can try resetting the MMB0 by pressing **Reset** and then reloading the plug-in.

## 7 Evaluating Performance with the ADCPro Software

The evaluation software is based on ADCPro, a program that operates using a variety of plug-ins. (The ADS8638EVM plug-in is installed as described in the [Installation section](#)).

To use ADCPro, load an EVM plug-in and a test plug-in. To load an EVM plug-in, select it from the EVM menu. To load a test plug-in, select it from the Test menu. To unload a plug-in, select the *Unload* option from the corresponding menu. Only one of each kind of plug-in can be loaded at a time. If you select a different plug-in, the previous plug-in is unloaded.

### 7.1 Using the ADS8638EVM-PDK Plug-in

The ADS8638EVM-PDK plug-in for ADCPro provides complete control over all settings of the ADS8638. It consists of a tabbed interface, with different functions available on different tabs. These controls are described in this section.

You can adjust the ADS8638EVM settings when you are not acquiring data. During acquisition, all controls are disabled and settings may not be changed.

When you change a setting on the ADS8638EVM plug-in, the setting immediately updates on the board. Settings on the ADS8638EVM correspond to settings described in the [ADS8638 product data sheet](#) (available for download at [www.ti.com](http://www.ti.com)).

### 7.1.1 Plug-in Setup and The Device Config Tab

When the ADS86xxEVM plug-in is first loaded, you must select the device from the *Device Selection* tab found in the basic settings window. The ADC options are not available on the plug-in until the device is selected. Use [Figure 9](#) for reference.

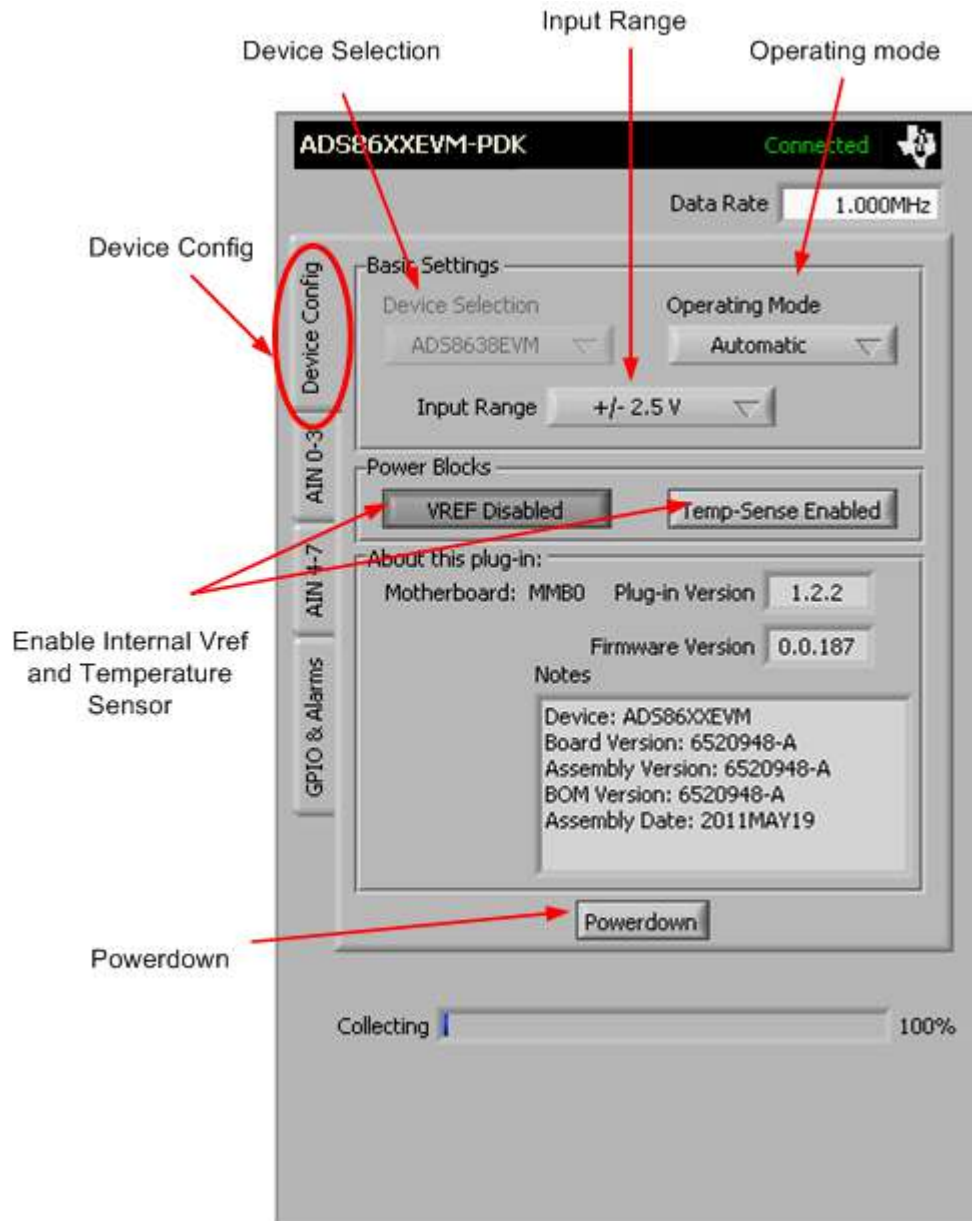

**Figure 9. Device Configuration**

After the ADC has been selected, the tabs on the left become available, including the plug-in options to configure the ADC. The *Device Config* tab is the default window and includes some of the basic settings to configure that ADC. Basic information, such as the Plug-in version and Firmware version, is shown here along with some simple settings use to set up the ADC according to user preferences.

The *Data Rate* control on the main plug-in window sets the data rate for the ADS8638. Changing the data rate controls the time between sequential conversions once the acquisition period begins.

In the Basic Settings window, the Operating Mode and Input Range options are available. The plug-in was designed to only use auto-mode channel sequencing, and therefore manual mode is not selectable. The input range option allows the user to select the desired analog input voltage range from +5 V, +10 V,  $\pm 2.5$  V,  $\pm 5$  V, or  $\pm 10$  V. This setting becomes the range for all the channels that are enabled at the time of data acquisition.

The Power Blocks window includes buttons to enable the internal reference voltage and the internal temperature sensor. *By default, these two options are disabled and are enabled once the appropriate button is selected.*

The *About this plug-in* tab has the plug-in version history along with the firmware version. The *Notes* indicator shows manufacturing information about the EVM that is stored in the EVM EEPROM, and may show relevant notes about the plug-in or firmware code, if any.

At the bottom of the Device Config window is the **PowerDown** button. Use this button to direct the processor to write the command that puts the ADC into power-down mode.

### 7.1.2 Channels 1-4 Tab and 5-8 Tab

These two tabs, as shown in [Figure 10](#), are used to enable/disable the ADC channels as well as configure the alarm states. By default, all of the eight channels are disabled. Before an acquisition can be performed, at least one channel must be enabled. Once a channel is enabled, the alarm high and alarm low thresholds can be set along with the respective hysteresis limits. As the converted result exceeds the alarm threshold, the LED found on the EVM board should turn on to indicate an alarm.

As multiple channels are enabled, the effective data rate decreases. The ADS8638 uses an architecture that relies on an internal cycling mux, requiring the conversions to be completed in a sequential order rather than simultaneously. The data rate displayed in the top right corner of the plugin refers to all enabled channels to be converted.



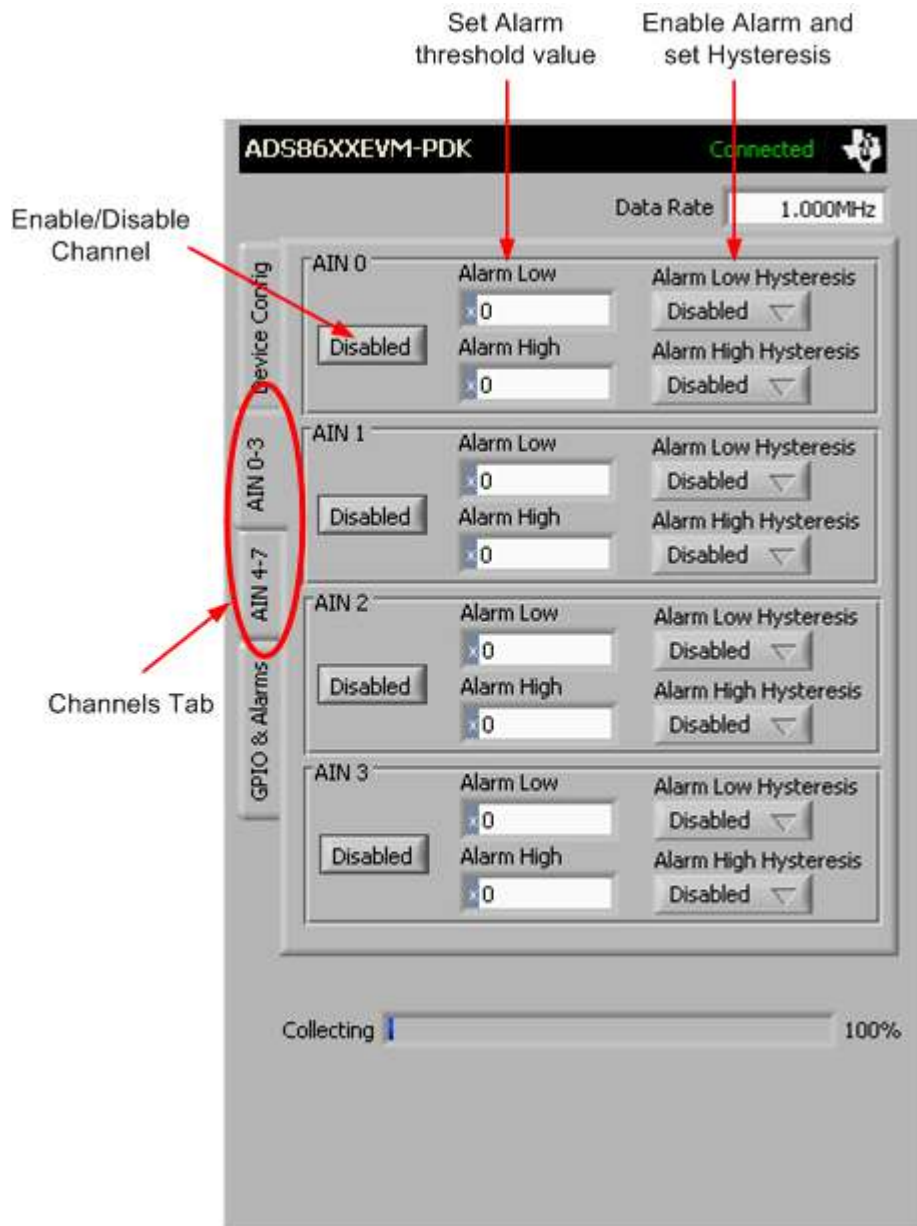

Figure 10. Channels Tabs

### 7.1.3 GPIO & Alarms Tab

The *GPIO & Alarms* tab (as shown in Figure 11) includes some of the additional options found within the ADS8638. Here, the software provides access to setting the GPIO as either a power-down input or an alarm state output. This I/O line is routed to the onboard LED on the evaluation board to indicate when the alarm is active.

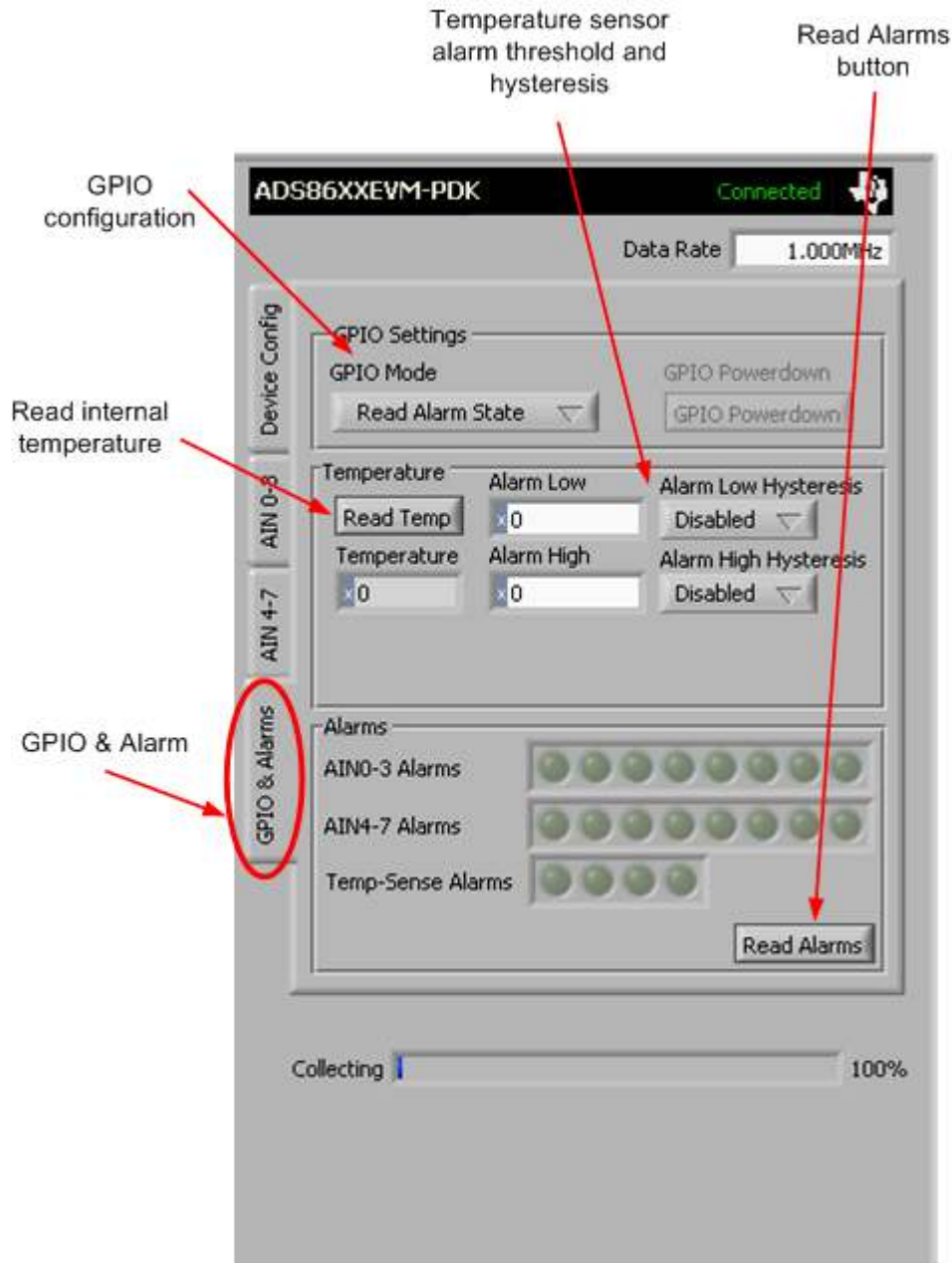

Figure 11. GPIOs & Alarms Tab

The Temperature control is used to read back the temperature control and enable high and low alarms along with hysteresis. When reading back the temperature reading, the result is read back in codes where it must be converted to a temperature using the parameters described in the ADS8638 product data sheet. The high and low alarms, along with hysteresis settings, behave the same way that the analog input channel alarm settings do.

After an acquisition, the **Read Alarms** button allows the user to read back the specific alarms that reported a fault. When the button is pressed, the firmware uses the sticky register read command; once the alarms are read, they are set back to zero. Each channel has two alarms, a high alarm and a low alarm; both are placed side by side in the alarm list. When the Read Alarms button is pressed, the LED corresponding to the alarm limit that was breached is enabled.

#### **7.1.4 Collecting Data**

Once you have configured the ADS8638 for your test scenario, press the **ADCPro Acquire** button to start the collection of the number of data points specified in the Test plug-in Block Size control. The ADS8638EVM-PDK plug-in disables all the front panel controls while acquiring, and displays a progress bar.

## **7.2 Troubleshooting**

If ADCPro stops responding while the ADS8638EVM-PDK is connected, try unplugging the power supply from the PDK. Unload and reload the plug-in before reapplying power to the PDK.

## 8 EVM Bill of Materials, Schematic, and Layout

Table 6 contains a complete bill of materials for the modular ADS8638EVM. The schematic diagram is also provided for reference. Figure 12 through Figure 15 show the PCB layouts.

### 8.1 Parts List

**NOTE:** All components should be compliant with the European Union Restriction on Use of Hazardous Substances (RoHS) Directive. Some part numbers may be either leaded or RoHS. Verify that purchased components are RoHS-compliant. (For more information about TI's position on RoHS compliance, see the [Quality and Eco-Info information on the TI web site.](#))

**Table 6. Bill of Materials**

Item	Qty	Ref Des	Description	MFR	Part Number
1	1	N/A	Printed wiring board	n/a	6520948
2	3	C1, C4, C11	Capacitor, ceramic, 1.0 $\mu$ F 16V 10% X5R 0603	Murata	GRM188R61C105KA93D
3	4	C2, C3, C12, C13	Capacitor, ceramic, 10 $\mu$ F 16V X5R 0805	Murata	GRM21BR61C106KE15L
4	4	C5, C8, C15, C18	Capacitor, ceramic, 0.1 $\mu$ F 16V 10% X7R 0603	Murata	GRM188R71C104KA01D
5	1	C6	Capacitor, ceramic, 1 $\mu$ F 50V X7R 1206	Murata	GRM31CR71H105KA61L
6	3	C9, C10, C19	Capacitor, ceramic, 10 $\mu$ F 6.3V X5R 0603	Murata	GRM188R60J106ME47D
7	0	C7, C17	Not installed		
8	1	C14	Capacitor, ceramic, 1000 pF 50V 5% C0G 0603	Murata	GRM1885C1H102JA01D
9	1	C16	Capacitor, tantalum, 10 $\mu$ F 16V 10% SMD	Kemet	T494B106K016AT
10	1	D1	LED 565 nm, green diff 1206 SMD	Lumex Opto	SML-LX1206GW-TR
11	2	J1A, J2A (Top Side)	10-pin, dual row, SM Header (20 Pos.)	Samtec	TSM-110-01-T-DV-P
12	2	J1B, J2B (Bottom Side)	10-pin, dual row, SM Header (20 Pos.)	Samtec	SSW-110-22-F-D-VS-K
13	1	J3A (Top Side)	5-pin, dual row, SM Header (10 Pos.)	Samtec	TSM-105-01-T-DV-P
14	1	J3B (Bottom Side)	5-pin, dual row, SM Header (10 Pos.)	Samtec	SSW-105-22-F-D-VS-K
15	2	JP1, JP2	Header strip, 3-pin (1x3)	Samtec	TSW-103-07-L-S
16	1	JP3	Header ltrip, 12-pin (2x6)	Samtec	TSW-106-07-L-D
17	0	JP4	Not installed		
18	1	JP5	2-position jumper _ .1" spacing	Samtec	TSW-102-07-T-S
19	4	R1, R2, R3, R4, R7	Resistor, 33 $\Omega$ 1/10W 5% 0603 SMD	Panasonic	ERJ-3GEYJ330V
20	5	R5, R6, R8, R9, R12	Resistor, 0 $\Omega$ 1/10W 5% 0603 SMD	Panasonic	ERJ-3GEY0R00V
21	2	R10, R11	Resistor, 20 $\Omega$ 1/10W 5% 0603 SMD	Panasonic	ERJ-3GEYJ200V
22	2	R13, R14	Resistor, 10 k $\Omega$ 1/10W 5% 0603 SMD	Panasonic	ERJ-3GEYJ103V
23	1	R15	Resistor, 470 $\Omega$ 1/10W 5% 0603 SMD	Panasonic	ERJ-3GEYJ471V
24	0	RA1	Not installed		
25	2	TP1, TP2	Test point: single .025-Pin, Black	Keystone	5001
26	1	TP3	Test point: single .025-Pin, Red	Keystone	5000
27	1	U1	ADS8638, 8-channel 12-bit HV MUX SAR ADC SPI	Texas Instruments	ADS8638SRGER

**Table 6. Bill of Materials (continued)**

Item	Qty	Ref Des	Description	MFR	Part Number
28	1	U2	Precision voltage reference 2.5 V, 8SOIC	Texas Instruments	REF5025AID
29	1	U3	IC Op Amp GP R-R 90 kHz SOT23-5	Texas Instruments	OPA379AIDBVT
30	1	U4	IC Op Amp GP R-R 80 MHz SGL 8SOIC	Texas Instruments	OPA140AID
31	1	U5	Logic Single Schmitt-Trigger Buffer	Texas Instruments	SN74LVC1G17DBVR
32	1	U6	IC EEPROM 256Kbit 400 kHz 8TSSOP	Microchip	24AA256-I/ST
33	6	N/A	Shunt Jumper .1" Black gold	3M	969102-0000-DA

## 8.2 Board Layouts

**NOTE:** Board layouts are not to scale. These images are intended to show how the board is laid out; they are not intended to be used for manufacturing ADS8638EVM PCBs.

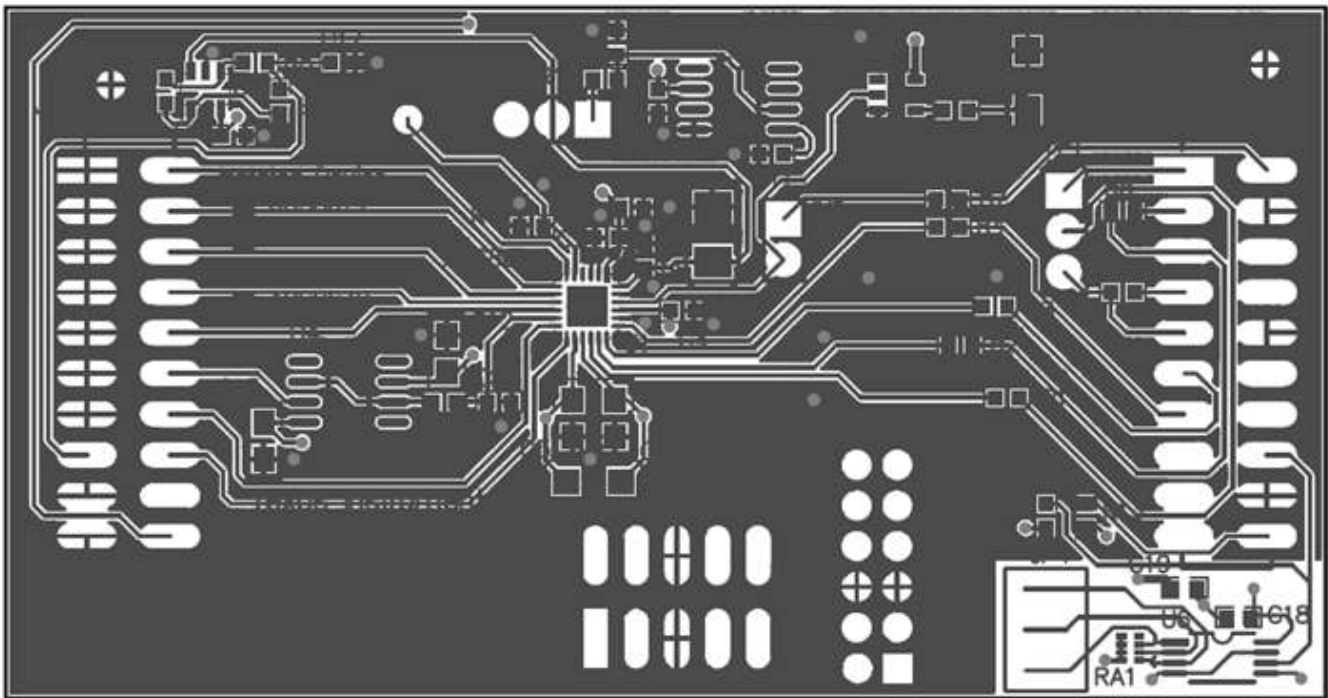

**Figure 12. ADS8638EVM PCB: Top Layer**

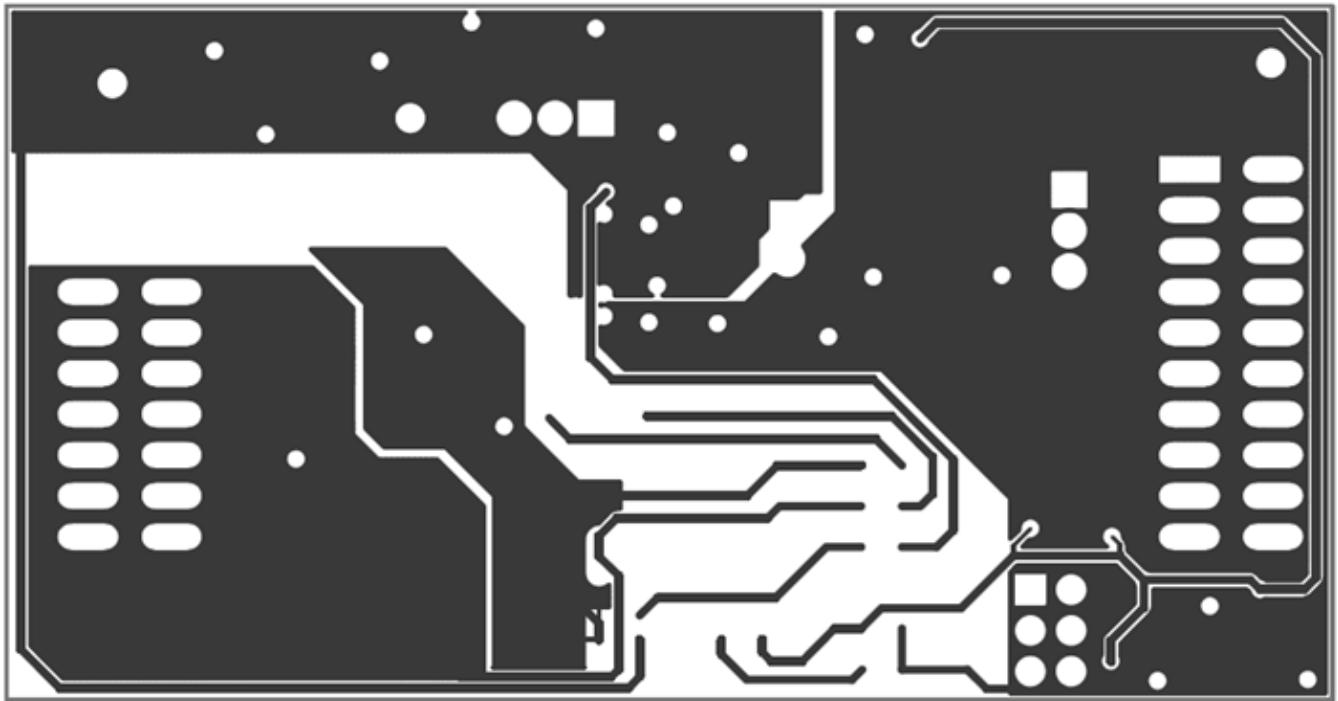

Figure 13. ADS8638EVM PCB: Mid Layer

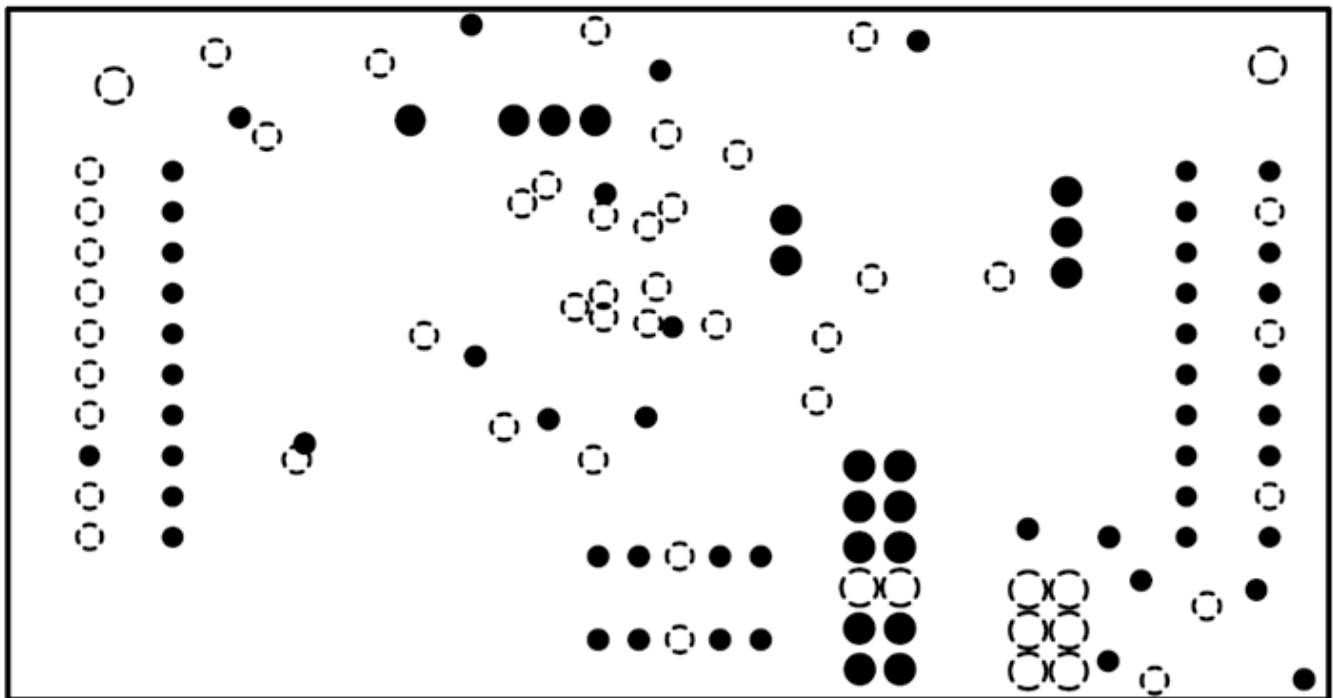
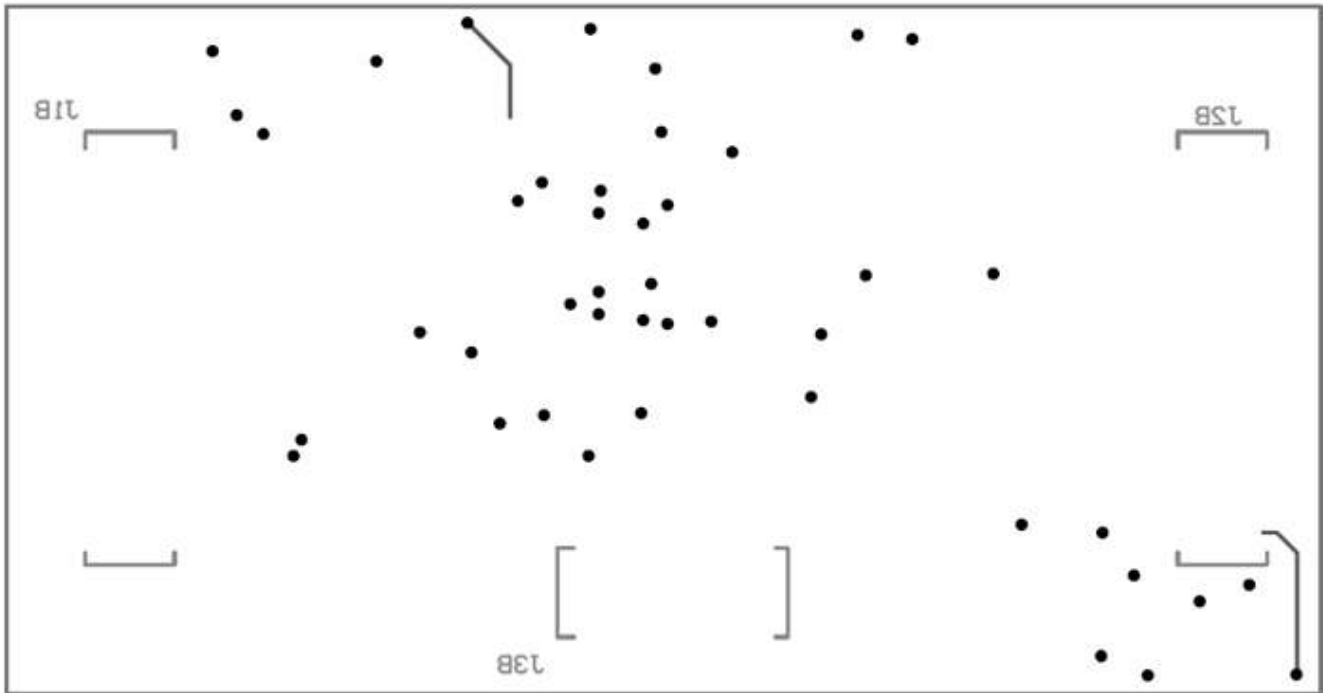

Figure 14. ADS8638EVM PCB: Ground Layer



**Figure 15. ADS8638EVM PCB: Bottom Layer**

### Revision History

Changes from Original (July 2011) to A Revision	Page
• Replaced reference of wall supply to external supply in the <i>Setting Up the ADS8638EVM-PDK</i> section. ....	9
• Modified the <i>MMB0 Initial Setup</i> image. ....	9
• Modified the <i>Laboratory Power-Supply Connections</i> image. ....	11

NOTE: Page numbers for previous revisions may differ from page numbers in the current version.

## STANDARD TERMS AND CONDITIONS FOR EVALUATION MODULES

1. *Delivery:* TI delivers TI evaluation boards, kits, or modules, including any accompanying demonstration software, components, or documentation (collectively, an "EVM" or "EVMs") to the User ("User") in accordance with the terms and conditions set forth herein. Acceptance of the EVM is expressly subject to the following terms and conditions.
  - 1.1 EVMs are intended solely for product or software developers for use in a research and development setting to facilitate feasibility evaluation, experimentation, or scientific analysis of TI semiconductors products. EVMs have no direct function and are not finished products. EVMs shall not be directly or indirectly assembled as a part or subassembly in any finished product. For clarification, any software or software tools provided with the EVM ("Software") shall not be subject to the terms and conditions set forth herein but rather shall be subject to the applicable terms and conditions that accompany such Software
  - 1.2 EVMs are not intended for consumer or household use. EVMs may not be sold, sublicensed, leased, rented, loaned, assigned, or otherwise distributed for commercial purposes by Users, in whole or in part, or used in any finished product or production system.
2. *Limited Warranty and Related Remedies/Disclaimers:*
  - 2.1 These terms and conditions do not apply to Software. The warranty, if any, for Software is covered in the applicable Software License Agreement.
  - 2.2 TI warrants that the TI EVM will conform to TI's published specifications for ninety (90) days after the date TI delivers such EVM to User. Notwithstanding the foregoing, TI shall not be liable for any defects that are caused by neglect, misuse or mistreatment by an entity other than TI, including improper installation or testing, or for any EVMs that have been altered or modified in any way by an entity other than TI. Moreover, TI shall not be liable for any defects that result from User's design, specifications or instructions for such EVMs. Testing and other quality control techniques are used to the extent TI deems necessary or as mandated by government requirements. TI does not test all parameters of each EVM.
  - 2.3 If any EVM fails to conform to the warranty set forth above, TI's sole liability shall be at its option to repair or replace such EVM, or credit User's account for such EVM. TI's liability under this warranty shall be limited to EVMs that are returned during the warranty period to the address designated by TI and that are determined by TI not to conform to such warranty. If TI elects to repair or replace such EVM, TI shall have a reasonable time to repair such EVM or provide replacements. Repaired EVMs shall be warranted for the remainder of the original warranty period. Replaced EVMs shall be warranted for a new full ninety (90) day warranty period.
3. *Regulatory Notices:*
  - 3.1 *United States*
    - 3.1.1 *Notice applicable to EVMs not FCC-Approved:*

This kit is designed to allow product developers to evaluate electronic components, circuitry, or software associated with the kit to determine whether to incorporate such items in a finished product and software developers to write software applications for use with the end product. This kit is not a finished product and when assembled may not be resold or otherwise marketed unless all required FCC equipment authorizations are first obtained. Operation is subject to the condition that this product not cause harmful interference to licensed radio stations and that this product accept harmful interference. Unless the assembled kit is designed to operate under part 15, part 18 or part 95 of this chapter, the operator of the kit must operate under the authority of an FCC license holder or must secure an experimental authorization under part 5 of this chapter.
    - 3.1.2 *For EVMs annotated as FCC – FEDERAL COMMUNICATIONS COMMISSION Part 15 Compliant:*

### CAUTION

This device complies with part 15 of the FCC Rules. Operation is subject to the following two conditions: (1) This device may not cause harmful interference, and (2) this device must accept any interference received, including interference that may cause undesired operation.

Changes or modifications not expressly approved by the party responsible for compliance could void the user's authority to operate the equipment.

### FCC Interference Statement for Class A EVM devices

*NOTE: This equipment has been tested and found to comply with the limits for a Class A digital device, pursuant to part 15 of the FCC Rules. These limits are designed to provide reasonable protection against harmful interference when the equipment is operated in a commercial environment. This equipment generates, uses, and can radiate radio frequency energy and, if not installed and used in accordance with the instruction manual, may cause harmful interference to radio communications. Operation of this equipment in a residential area is likely to cause harmful interference in which case the user will be required to correct the interference at his own expense.*



## FCC Interference Statement for Class B EVM devices

*NOTE: This equipment has been tested and found to comply with the limits for a Class B digital device, pursuant to part 15 of the FCC Rules. These limits are designed to provide reasonable protection against harmful interference in a residential installation. This equipment generates, uses and can radiate radio frequency energy and, if not installed and used in accordance with the instructions, may cause harmful interference to radio communications. However, there is no guarantee that interference will not occur in a particular installation. If this equipment does cause harmful interference to radio or television reception, which can be determined by turning the equipment off and on, the user is encouraged to try to correct the interference by one or more of the following measures:*

- Reorient or relocate the receiving antenna.
- Increase the separation between the equipment and receiver.
- Connect the equipment into an outlet on a circuit different from that to which the receiver is connected.
- Consult the dealer or an experienced radio/TV technician for help.

### 3.2 Canada

3.2.1 For EVMs issued with an Industry Canada Certificate of Conformance to RSS-210

#### Concerning EVMs Including Radio Transmitters:

This device complies with Industry Canada license-exempt RSS standard(s). Operation is subject to the following two conditions: (1) this device may not cause interference, and (2) this device must accept any interference, including interference that may cause undesired operation of the device.

#### Concernant les EVMs avec appareils radio:

Le présent appareil est conforme aux CNR d'Industrie Canada applicables aux appareils radio exempts de licence. L'exploitation est autorisée aux deux conditions suivantes: (1) l'appareil ne doit pas produire de brouillage, et (2) l'utilisateur de l'appareil doit accepter tout brouillage radioélectrique subi, même si le brouillage est susceptible d'en compromettre le fonctionnement.

#### Concerning EVMs Including Detachable Antennas:

Under Industry Canada regulations, this radio transmitter may only operate using an antenna of a type and maximum (or lesser) gain approved for the transmitter by Industry Canada. To reduce potential radio interference to other users, the antenna type and its gain should be so chosen that the equivalent isotropically radiated power (e.i.r.p.) is not more than that necessary for successful communication. This radio transmitter has been approved by Industry Canada to operate with the antenna types listed in the user guide with the maximum permissible gain and required antenna impedance for each antenna type indicated. Antenna types not included in this list, having a gain greater than the maximum gain indicated for that type, are strictly prohibited for use with this device.

#### Concernant les EVMs avec antennes détachables

Conformément à la réglementation d'Industrie Canada, le présent émetteur radio peut fonctionner avec une antenne d'un type et d'un gain maximal (ou inférieur) approuvé pour l'émetteur par Industrie Canada. Dans le but de réduire les risques de brouillage radioélectrique à l'intention des autres utilisateurs, il faut choisir le type d'antenne et son gain de sorte que la puissance isotrope rayonnée équivalente (p.i.r.e.) ne dépasse pas l'intensité nécessaire à l'établissement d'une communication satisfaisante. Le présent émetteur radio a été approuvé par Industrie Canada pour fonctionner avec les types d'antenne énumérés dans le manuel d'usage et ayant un gain admissible maximal et l'impédance requise pour chaque type d'antenne. Les types d'antenne non inclus dans cette liste, ou dont le gain est supérieur au gain maximal indiqué, sont strictement interdits pour l'exploitation de l'émetteur.

### 3.3 Japan

3.3.1 *Notice for EVMs delivered in Japan:* Please see [http://www.tij.co.jp/lstds/ti\\_ja/general/eStore/notice\\_01.page](http://www.tij.co.jp/lstds/ti_ja/general/eStore/notice_01.page) 日本国内に輸入される評価用キット、ボードについては、次のところをご覧ください。  
[http://www.tij.co.jp/lstds/ti\\_ja/general/eStore/notice\\_01.page](http://www.tij.co.jp/lstds/ti_ja/general/eStore/notice_01.page)

3.3.2 *Notice for Users of EVMs Considered "Radio Frequency Products" in Japan:* EVMs entering Japan may not be certified by TI as conforming to Technical Regulations of Radio Law of Japan.

If User uses EVMs in Japan, not certified to Technical Regulations of Radio Law of Japan, User is required by Radio Law of Japan to follow the instructions below with respect to EVMs:

1. Use EVMs in a shielded room or any other test facility as defined in the notification #173 issued by Ministry of Internal Affairs and Communications on March 28, 2006, based on Sub-section 1.1 of Article 6 of the Ministry's Rule for Enforcement of Radio Law of Japan,
2. Use EVMs only after User obtains the license of Test Radio Station as provided in Radio Law of Japan with respect to EVMs, or
3. Use of EVMs only after User obtains the Technical Regulations Conformity Certification as provided in Radio Law of Japan with respect to EVMs. Also, do not transfer EVMs, unless User gives the same notice above to the transferee. Please note that if User does not follow the instructions above, User will be subject to penalties of Radio Law of Japan.

【無線電波を送信する製品の開発キットをお使いになる際の注意事項】 開発キットの中には技術基準適合証明を受けていないものがあります。技術適合証明を受けていないもののご使用に際しては、電波法遵守のため、以下のいずれかの措置を取っていただく必要がありますのでご注意ください。

1. 電波法施行規則第6条第1項第1号に基づく平成18年3月28日総務省告示第173号で定められた電波暗室等の試験設備でご使用いただく。
2. 実験局の免許を取得後ご使用いただく。
3. 技術基準適合証明を取得後ご使用いただく。

なお、本製品は、上記の「ご使用にあたっての注意」を譲渡先、移転先に通知しない限り、譲渡、移転できないものとします。

上記を遵守頂けない場合は、電波法の罰則が適用される可能性があることをご留意ください。日本テキサス・インスツルメンツ株式会社  
東京都新宿区西新宿 6 丁目 2 4 番 1 号  
西新宿三井ビル

3.3.3 *Notice for EVMs for Power Line Communication:* Please see [http://www.tij.co.jp/llds/ti\\_ja/general/eStore/notice\\_02.page](http://www.tij.co.jp/llds/ti_ja/general/eStore/notice_02.page)  
電力線搬送波通信についての開発キットをお使いになる際の注意事項については、次のところをご覧ください。[http://www.tij.co.jp/llds/ti\\_ja/general/eStore/notice\\_02.page](http://www.tij.co.jp/llds/ti_ja/general/eStore/notice_02.page)

#### 4 *EVM Use Restrictions and Warnings:*

4.1 EVMS ARE NOT FOR USE IN FUNCTIONAL SAFETY AND/OR SAFETY CRITICAL EVALUATIONS, INCLUDING BUT NOT LIMITED TO EVALUATIONS OF LIFE SUPPORT APPLICATIONS.

4.2 User must read and apply the user guide and other available documentation provided by TI regarding the EVM prior to handling or using the EVM, including without limitation any warning or restriction notices. The notices contain important safety information related to, for example, temperatures and voltages.

#### 4.3 *Safety-Related Warnings and Restrictions:*

4.3.1 User shall operate the EVM within TI's recommended specifications and environmental considerations stated in the user guide, other available documentation provided by TI, and any other applicable requirements and employ reasonable and customary safeguards. Exceeding the specified performance ratings and specifications (including but not limited to input and output voltage, current, power, and environmental ranges) for the EVM may cause personal injury or death, or property damage. If there are questions concerning performance ratings and specifications, User should contact a TI field representative prior to connecting interface electronics including input power and intended loads. Any loads applied outside of the specified output range may also result in unintended and/or inaccurate operation and/or possible permanent damage to the EVM and/or interface electronics. Please consult the EVM user guide prior to connecting any load to the EVM output. If there is uncertainty as to the load specification, please contact a TI field representative. During normal operation, even with the inputs and outputs kept within the specified allowable ranges, some circuit components may have elevated case temperatures. These components include but are not limited to linear regulators, switching transistors, pass transistors, current sense resistors, and heat sinks, which can be identified using the information in the associated documentation. When working with the EVM, please be aware that the EVM may become very warm.

4.3.2 EVMs are intended solely for use by technically qualified, professional electronics experts who are familiar with the dangers and application risks associated with handling electrical mechanical components, systems, and subsystems. User assumes all responsibility and liability for proper and safe handling and use of the EVM by User or its employees, affiliates, contractors or designees. User assumes all responsibility and liability to ensure that any interfaces (electronic and/or mechanical) between the EVM and any human body are designed with suitable isolation and means to safely limit accessible leakage currents to minimize the risk of electrical shock hazard. User assumes all responsibility and liability for any improper or unsafe handling or use of the EVM by User or its employees, affiliates, contractors or designees.

4.4 User assumes all responsibility and liability to determine whether the EVM is subject to any applicable international, federal, state, or local laws and regulations related to User's handling and use of the EVM and, if applicable, User assumes all responsibility and liability for compliance in all respects with such laws and regulations. User assumes all responsibility and liability for proper disposal and recycling of the EVM consistent with all applicable international, federal, state, and local requirements.

5. *Accuracy of Information:* To the extent TI provides information on the availability and function of EVMs, TI attempts to be as accurate as possible. However, TI does not warrant the accuracy of EVM descriptions, EVM availability or other information on its websites as accurate, complete, reliable, current, or error-free.

6. *Disclaimers:*
- 6.1 EXCEPT AS SET FORTH ABOVE, EVMS AND ANY WRITTEN DESIGN MATERIALS PROVIDED WITH THE EVM (AND THE DESIGN OF THE EVM ITSELF) ARE PROVIDED "AS IS" AND "WITH ALL FAULTS." TI DISCLAIMS ALL OTHER WARRANTIES, EXPRESS OR IMPLIED, REGARDING SUCH ITEMS, INCLUDING BUT NOT LIMITED TO ANY IMPLIED WARRANTIES OF MERCHANTABILITY OR FITNESS FOR A PARTICULAR PURPOSE OR NON-INFRINGEMENT OF ANY THIRD PARTY PATENTS, COPYRIGHTS, TRADE SECRETS OR OTHER INTELLECTUAL PROPERTY RIGHTS.
- 6.2 EXCEPT FOR THE LIMITED RIGHT TO USE THE EVM SET FORTH HEREIN, NOTHING IN THESE TERMS AND CONDITIONS SHALL BE CONSTRUED AS GRANTING OR CONFERRING ANY RIGHTS BY LICENSE, PATENT, OR ANY OTHER INDUSTRIAL OR INTELLECTUAL PROPERTY RIGHT OF TI, ITS SUPPLIERS/LICENSORS OR ANY OTHER THIRD PARTY, TO USE THE EVM IN ANY FINISHED END-USER OR READY-TO-USE FINAL PRODUCT, OR FOR ANY INVENTION, DISCOVERY OR IMPROVEMENT MADE, CONCEIVED OR ACQUIRED PRIOR TO OR AFTER DELIVERY OF THE EVM.
7. *USER'S INDEMNITY OBLIGATIONS AND REPRESENTATIONS.* USER WILL DEFEND, INDEMNIFY AND HOLD TI, ITS LICENSORS AND THEIR REPRESENTATIVES HARMLESS FROM AND AGAINST ANY AND ALL CLAIMS, DAMAGES, LOSSES, EXPENSES, COSTS AND LIABILITIES (COLLECTIVELY, "CLAIMS") ARISING OUT OF OR IN CONNECTION WITH ANY HANDLING OR USE OF THE EVM THAT IS NOT IN ACCORDANCE WITH THESE TERMS AND CONDITIONS. THIS OBLIGATION SHALL APPLY WHETHER CLAIMS ARISE UNDER STATUTE, REGULATION, OR THE LAW OF TORT, CONTRACT OR ANY OTHER LEGAL THEORY, AND EVEN IF THE EVM FAILS TO PERFORM AS DESCRIBED OR EXPECTED.
8. *Limitations on Damages and Liability:*
- 8.1 *General Limitations.* IN NO EVENT SHALL TI BE LIABLE FOR ANY SPECIAL, COLLATERAL, INDIRECT, PUNITIVE, INCIDENTAL, CONSEQUENTIAL, OR EXEMPLARY DAMAGES IN CONNECTION WITH OR ARISING OUT OF THESE TERMS AND CONDITIONS OR THE USE OF THE EVMS PROVIDED HEREUNDER, REGARDLESS OF WHETHER TI HAS BEEN ADVISED OF THE POSSIBILITY OF SUCH DAMAGES. EXCLUDED DAMAGES INCLUDE, BUT ARE NOT LIMITED TO, COST OF REMOVAL OR REINSTALLATION, ANCILLARY COSTS TO THE PROCUREMENT OF SUBSTITUTE GOODS OR SERVICES, RETESTING, OUTSIDE COMPUTER TIME, LABOR COSTS, LOSS OF GOODWILL, LOSS OF PROFITS, LOSS OF SAVINGS, LOSS OF USE, LOSS OF DATA, OR BUSINESS INTERRUPTION. NO CLAIM, SUIT OR ACTION SHALL BE BROUGHT AGAINST TI MORE THAN ONE YEAR AFTER THE RELATED CAUSE OF ACTION HAS OCCURRED.
- 8.2 *Specific Limitations.* IN NO EVENT SHALL TI'S AGGREGATE LIABILITY FROM ANY WARRANTY OR OTHER OBLIGATION ARISING OUT OF OR IN CONNECTION WITH THESE TERMS AND CONDITIONS, OR ANY USE OF ANY TI EVM PROVIDED HEREUNDER, EXCEED THE TOTAL AMOUNT PAID TO TI FOR THE PARTICULAR UNITS SOLD UNDER THESE TERMS AND CONDITIONS WITH RESPECT TO WHICH LOSSES OR DAMAGES ARE CLAIMED. THE EXISTENCE OF MORE THAN ONE CLAIM AGAINST THE PARTICULAR UNITS SOLD TO USER UNDER THESE TERMS AND CONDITIONS SHALL NOT ENLARGE OR EXTEND THIS LIMIT.
9. *Return Policy.* Except as otherwise provided, TI does not offer any refunds, returns, or exchanges. Furthermore, no return of EVM(s) will be accepted if the package has been opened and no return of the EVM(s) will be accepted if they are damaged or otherwise not in a resalable condition. If User feels it has been incorrectly charged for the EVM(s) it ordered or that delivery violates the applicable order, User should contact TI. All refunds will be made in full within thirty (30) working days from the return of the components(s), excluding any postage or packaging costs.
10. *Governing Law:* These terms and conditions shall be governed by and interpreted in accordance with the laws of the State of Texas, without reference to conflict-of-laws principles. User agrees that non-exclusive jurisdiction for any dispute arising out of or relating to these terms and conditions lies within courts located in the State of Texas and consents to venue in Dallas County, Texas. Notwithstanding the foregoing, any judgment may be enforced in any United States or foreign court, and TI may seek injunctive relief in any United States or foreign court.

Mailing Address: Texas Instruments, Post Office Box 655303, Dallas, Texas 75265  
Copyright © 2015, Texas Instruments Incorporated

## IMPORTANT NOTICE

Texas Instruments Incorporated and its subsidiaries (TI) reserve the right to make corrections, enhancements, improvements and other changes to its semiconductor products and services per JESD46, latest issue, and to discontinue any product or service per JESD48, latest issue. Buyers should obtain the latest relevant information before placing orders and should verify that such information is current and complete. All semiconductor products (also referred to herein as "components") are sold subject to TI's terms and conditions of sale supplied at the time of order acknowledgment.

TI warrants performance of its components to the specifications applicable at the time of sale, in accordance with the warranty in TI's terms and conditions of sale of semiconductor products. Testing and other quality control techniques are used to the extent TI deems necessary to support this warranty. Except where mandated by applicable law, testing of all parameters of each component is not necessarily performed.

TI assumes no liability for applications assistance or the design of Buyers' products. Buyers are responsible for their products and applications using TI components. To minimize the risks associated with Buyers' products and applications, Buyers should provide adequate design and operating safeguards.

TI does not warrant or represent that any license, either express or implied, is granted under any patent right, copyright, mask work right, or other intellectual property right relating to any combination, machine, or process in which TI components or services are used. Information published by TI regarding third-party products or services does not constitute a license to use such products or services or a warranty or endorsement thereof. Use of such information may require a license from a third party under the patents or other intellectual property of the third party, or a license from TI under the patents or other intellectual property of TI.

Reproduction of significant portions of TI information in TI data books or data sheets is permissible only if reproduction is without alteration and is accompanied by all associated warranties, conditions, limitations, and notices. TI is not responsible or liable for such altered documentation. Information of third parties may be subject to additional restrictions.

Resale of TI components or services with statements different from or beyond the parameters stated by TI for that component or service voids all express and any implied warranties for the associated TI component or service and is an unfair and deceptive business practice. TI is not responsible or liable for any such statements.

Buyer acknowledges and agrees that it is solely responsible for compliance with all legal, regulatory and safety-related requirements concerning its products, and any use of TI components in its applications, notwithstanding any applications-related information or support that may be provided by TI. Buyer represents and agrees that it has all the necessary expertise to create and implement safeguards which anticipate dangerous consequences of failures, monitor failures and their consequences, lessen the likelihood of failures that might cause harm and take appropriate remedial actions. Buyer will fully indemnify TI and its representatives against any damages arising out of the use of any TI components in safety-critical applications.

In some cases, TI components may be promoted specifically to facilitate safety-related applications. With such components, TI's goal is to help enable customers to design and create their own end-product solutions that meet applicable functional safety standards and requirements. Nonetheless, such components are subject to these terms.

No TI components are authorized for use in FDA Class III (or similar life-critical medical equipment) unless authorized officers of the parties have executed a special agreement specifically governing such use.

Only those TI components which TI has specifically designated as military grade or "enhanced plastic" are designed and intended for use in military/aerospace applications or environments. Buyer acknowledges and agrees that any military or aerospace use of TI components which have **not** been so designated is solely at the Buyer's risk, and that Buyer is solely responsible for compliance with all legal and regulatory requirements in connection with such use.

TI has specifically designated certain components as meeting ISO/TS16949 requirements, mainly for automotive use. In any case of use of non-designated products, TI will not be responsible for any failure to meet ISO/TS16949.

### Products

Audio	<a href="http://www.ti.com/audio">www.ti.com/audio</a>
Amplifiers	<a href="http://amplifier.ti.com">amplifier.ti.com</a>
Data Converters	<a href="http://dataconverter.ti.com">dataconverter.ti.com</a>
DLP® Products	<a href="http://www.dlp.com">www.dlp.com</a>
DSP	<a href="http://dsp.ti.com">dsp.ti.com</a>
Clocks and Timers	<a href="http://www.ti.com/clocks">www.ti.com/clocks</a>
Interface	<a href="http://interface.ti.com">interface.ti.com</a>
Logic	<a href="http://logic.ti.com">logic.ti.com</a>
Power Mgmt	<a href="http://power.ti.com">power.ti.com</a>
Microcontrollers	<a href="http://microcontroller.ti.com">microcontroller.ti.com</a>
RFID	<a href="http://www.ti-rfid.com">www.ti-rfid.com</a>
OMAP Applications Processors	<a href="http://www.ti.com/omap">www.ti.com/omap</a>
Wireless Connectivity	<a href="http://www.ti.com/wirelessconnectivity">www.ti.com/wirelessconnectivity</a>

### Applications

Automotive and Transportation	<a href="http://www.ti.com/automotive">www.ti.com/automotive</a>
Communications and Telecom	<a href="http://www.ti.com/communications">www.ti.com/communications</a>
Computers and Peripherals	<a href="http://www.ti.com/computers">www.ti.com/computers</a>
Consumer Electronics	<a href="http://www.ti.com/consumer-apps">www.ti.com/consumer-apps</a>
Energy and Lighting	<a href="http://www.ti.com/energy">www.ti.com/energy</a>
Industrial	<a href="http://www.ti.com/industrial">www.ti.com/industrial</a>
Medical	<a href="http://www.ti.com/medical">www.ti.com/medical</a>
Security	<a href="http://www.ti.com/security">www.ti.com/security</a>
Space, Avionics and Defense	<a href="http://www.ti.com/space-avionics-defense">www.ti.com/space-avionics-defense</a>
Video and Imaging	<a href="http://www.ti.com/video">www.ti.com/video</a>

### TI E2E Community

[e2e.ti.com](http://e2e.ti.com)