

# TLV2460, TLV2461, TLV2462, TLV2463, TLV2464, TLV2465, TLV246xA FAMILY OF LOW-POWER RAIL-TO-RAIL INPUT/OUTPUT OPERATIONAL AMPLIFIERS WITH SHUTDOWN

SLOS220J – JULY 1998 – REVISED FEBRUARY 2004

- Rail-to-Rail Output Swing
- Gain Bandwidth Product . . . 6.4 MHz
- $\pm 80$  mA Output Drive Capability
- Supply Current . . . 500  $\mu$ A/channel
- Input Offset Voltage . . . 100  $\mu$ V
- Input Noise Voltage . . . 11 nV/ $\sqrt{\text{Hz}}$
- Slew Rate . . . 1.6 V/ $\mu$ s
- Micropower Shutdown Mode (TLV2460/3/5) . . . 0.3  $\mu$ A/Channel
- Universal Operational Amplifier EVM
- Available in Q-Temp Automotive HighRel Automotive Applications Configuration Control/Print Support Qualification to Automotive Standards

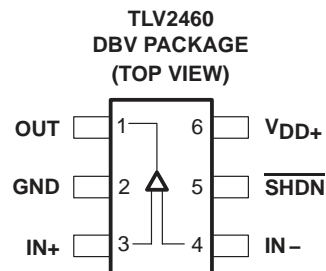

## description

The TLV246x is a family of low-power rail-to-rail input/output operational amplifiers specifically designed for portable applications. The input common-mode voltage range extends beyond the supply rails for maximum dynamic range in low-voltage systems. The amplifier output has rail-to-rail performance with high-output-drive capability, solving one of the limitations of older rail-to-rail input/output operational amplifiers. This rail-to-rail dynamic range and high output drive make the TLV246x ideal for buffering analog-to-digital converters.

The operational amplifier has 6.4 MHz of bandwidth and 1.6 V/ $\mu$ s of slew rate with only 500  $\mu$ A of supply current, providing good ac performance with low power consumption. Three members of the family offer a shutdown terminal, which places the amplifier in an ultralow supply current mode ( $I_{DD} = 0.3$   $\mu$ A/ch). While in shutdown, the operational-amplifier output is placed in a high-impedance state. DC applications are also well served with an input noise voltage of 11 nV/ $\sqrt{\text{Hz}}$  and input offset voltage of 100  $\mu$ V.

This family is available in the low-profile SOT23, MSOP, and TSSOP packages. The TLV2460 is the first rail-to-rail input/output operational amplifier with shutdown available in the 6-pin SOT23, making it perfect for high-density circuits. The family is specified over an expanded temperature range ( $T_A = -40^\circ\text{C}$  to  $125^\circ\text{C}$ ) for use in industrial control and automotive systems, and over the military temperature range ( $T_A = -55^\circ\text{C}$  to  $125^\circ\text{C}$ ) for use in military systems.

## SELECTION GUIDE

| DEVICE     | V <sub>DD</sub> [V] | V <sub>IO</sub> [ $\mu$ V] | I <sub>DD</sub> /ch [ $\mu$ A] | I <sub>IB</sub> [pA] | GBW [MHz] | SLEW RATE [V/ $\mu$ s] | V <sub>n</sub> , 1 kHz [nV/ $\sqrt{\text{Hz}}$ ] | I <sub>O</sub> [mA] | SHUTDOWN | RAIL-RAIL |
|------------|---------------------|----------------------------|--------------------------------|----------------------|-----------|------------------------|--|---------------------|----------|-----------|
| TLV246x(A) | 2.7–6               | 150                        | 550                            | 1300                 | 6.4       | 1.6                    | 11   | 25                  | Y        | I/O       |
| TLV277x(A) | 2.5–5.5             | 360                        | 1000                           | 2                    | 5.1       | 10.5                   | 17   | 6                   | Y        | O         |
| TLV247x(A) | 2.7–6               | 250                        | 600                            | 2.5                  | 2.8       | 1.5                    | 15   | 20                  | Y        | I/O       |
| TLV245x(A) | 2.7–6               | 20                         | 23                             | 500                  | 0.22      | 0.11                   | 52   | 10                  | Y        | I/O       |
| TLV225x(A) | 2.7–8               | 200                        | 35                             | 1                    | 0.2       | 0.12                   | 19   | 3                   | —        | —         |
| TLV226x(A) | 2.7–8               | 300                        | 200                            | 1                    | 0.71      | 0.55                   | 12   | 3                   | —        | —         |



Please be aware that an important notice concerning availability, standard warranty, and use in critical applications of Texas Instruments semiconductor products and disclaimers thereto appears at the end of this data sheet.

PRODUCTION DATA information is current as of publication date. Products conform to specifications per the terms of Texas Instruments standard warranty. Production processing does not necessarily include testing of all parameters.

 **TEXAS  
INSTRUMENTS**  
WWW.TI.COM

Copyright © 1998–2004, Texas Instruments Incorporated  
On products compliant to MIL-PRF-38535, all parameters are tested unless otherwise noted. On all other products, production processing does not necessarily include testing of all parameters.

# TLV2460, TLV2461, TLV2462, TLV2463, TLV2464, TLV2465, TLV246xA

## FAMILY OF LOW-POWER RAIL-TO-RAIL INPUT/OUTPUT OPERATIONAL AMPLIFIERS WITH SHUTDOWN

SLOS220J – JULY 1998 – REVISED FEBRUARY 2004

## TLV2460C//AI and TLV2461C//AI AVAILABLE OPTIONS

| T <sub>A</sub> | V <sub>IOmax</sub><br>AT 25°C | PACKAGED DEVICES         |                            |              |                          |
|----------------|-------------------------------|--------------------------|----------------------------|--------------|--------------------------|
|                |                               | SMALL OUTLINE<br>(D)     | SOT-23†<br>(DBV)           | SYMBOL       | PLASTIC DIP<br>(P)       |
| 0°C to 70°C    | 2000 μV                       | TLV2460CD<br>TLV2461CD   | TLV2460CDBV<br>TLV2461CDBV | VAOC<br>VAPC | TLV2460CP<br>TLV2461CP   |
| -40°C to 125°C | 2000 μV                       | TLV2460ID<br>TLV2461ID   | TLV2460IDBV<br>TLV2461IDBV | VAOI<br>VAPI | TLV2460IP<br>TLV2461IP   |
|                | 1500 μV                       | TLV2460AID<br>TLV2461AID | —<br>—                     | —<br>—       | TLV2460AIP<br>TLV2461AIP |

† This package is available taped and reeled. To order this packaging option, add an R suffix to the part number (e.g., TLV2460CDR).

‡ Chip forms are tested at T<sub>A</sub> = 25°C only.

## TLV2460M//AM//Q//AQ and TLV2461M//AM//Q//AQ AVAILABLE OPTIONS

| T <sub>A</sub> | V <sub>IOmax</sub><br>AT 25°C | PACKAGED DEVICES         |                            |                            |                            |                            |
|----------------|-------------------------------|--------------------------|----------------------------|----------------------------|----------------------------|----------------------------|
|                |                               | SMALL<br>OUTLINE†<br>(D) | SMALL<br>OUTLINE†<br>(PW)  | CERAMIC DIP<br>(JG)        | CERAMIC<br>FLATPACK<br>(U) | CHIP CARRIER<br>(FK)       |
| -40°C to 125°C | 2000 μV                       | TLV2460QD<br>TLV2461QD   | TLV2460QPW<br>TLV2461QPW   | —<br>—                     | —<br>—                     | —<br>—                     |
|                | 1500 μV                       | TLV2460AQD<br>TLV2461AQD | TLV2460AQPW<br>TLV2461AQPW | —<br>—                     | —<br>—                     | —<br>—                     |
| -55°C to 125°C | 2000 μV                       | —<br>—                   | —<br>—                     | TLV2460MJG<br>TLV2461MJG   | TLV2460MU<br>TLV2461MU     | TLV2460MFK<br>TLV2461MFK   |
|                | 1500 μV                       | —<br>—                   | —<br>—                     | TLV2460AMJG<br>TLV2461AMJG | TLV2460AMU<br>TLV2461AMU   | TLV2460AMFK<br>TLV2461AMFK |

† This package is available taped and reeled. To order this packaging option, add an R suffix to the part number (e.g., TLV2460QDR).

## TLV2462C//AI and TLV2463C//AI AVAILABLE OPTIONS

| T <sub>A</sub>    | V <sub>IOmax</sub><br>AT 25°C | PACKAGED DEVICES         |                  |         |                  |              |                    |                    |
|-------------------|-------------------------------|--------------------------|------------------|---------|------------------|--------------|--------------------|--------------------|
|                   |                               | SMALL<br>OUTLINE†<br>(D) | MSOP<br>(DGK)    | SYMBOL  | MSOP†<br>(DGS)   | SYMBOL       | PLASTIC DIP<br>(N) | PLASTIC DIP<br>(P) |
| 0°C to 70°C       | 2000 μV                       | TLV2462CD<br>TLV2463CD   | TLV2462CDGK<br>— | xxTIAAI | —<br>TLV2463CDGS | —<br>xxTIAAK | —<br>TLV2463CN     | TLV2462CP<br>—     |
| -40°C to<br>125°C | 2000 μV                       | TLV2462ID<br>TLV2463ID   | TLV2462IDGK<br>— | xxTIAAJ | —<br>TLV2463IDGS | —<br>xxTIAAL | —<br>TLV2463IN     | TLV2462IP<br>—     |
|                   | 1500 μV                       | TLV2462AID<br>TLV2463AID | —<br>—           | —<br>—  | —<br>—           | —<br>—       | —<br>TLV2463AIN    | TLV2462AIP<br>—    |

† This package is available taped and reeled. To order this packaging option, add an R suffix to the part number (e.g., TLV2462CDR).

‡ Chip forms are tested at T<sub>A</sub> = 25°C only.

# TLV2460, TLV2461, TLV2462, TLV2463, TLV2464, TLV2465, TLV246xA FAMILY OF LOW-POWER RAIL-TO-RAIL INPUT/OUTPUT OPERATIONAL AMPLIFIERS WITH SHUTDOWN

SLOS220J – JULY 1998 – REVISED FEBRUARY 2004

## TLV2462M/AM/Q/AQ and TLV2463M/AM/Q/AQ AVAILABLE OPTIONS

| T <sub>A</sub> | V <sub>IOmax</sub><br>AT 25°C | PACKAGED DEVICES         |                            |                     |                       |                            |                            |
|----------------|-------------------------------|--------------------------|----------------------------|---------------------|-----------------------|----------------------------|----------------------------|
|                |                               | SMALL<br>OUTLINE†<br>(D) | SMALL<br>OUTLINE†<br>(PW)  | CERAMIC DIP<br>(JG) | CERAMIC<br>DIP<br>(J) | CERAMIC<br>FLATPACK<br>(U) | CHIP CAR-<br>RIER<br>(FK)  |
| -40°C to 125°C | 2000 μV                       | TLV2462QD<br>TLV2463QD   | TLV2462QPW<br>TLV2463QPW   | —<br>—              | —<br>—                | —<br>—                     | —<br>—                     |
|                | 1500 μV                       | TLV2462AQD<br>TLV2463AQD | TLV2462AQPW<br>TLV2463AQPW | —<br>—              | —<br>—                | —<br>—                     | —<br>—                     |
| -55°C to 125°C | 2000 μV                       | —<br>—                   | —<br>—                     | TLV2462MJG<br>—     | —<br>TLV2463MJ        | TLV2462MU                  | TLV2462MFK<br>TLV2463MFK   |
|                | 1500 μV                       | —<br>—                   | —<br>—                     | TLV2462AMJG<br>—    | —<br>TLV2463AMJ       | TLV2462AMU                 | TLV2462AMFK<br>TLV2463AMFK |

† This package is available taped and reeled. To order this packaging option, add an R suffix to the part number (e.g., TLV2462QDR).

## TLV2464C//AI and TLV2465C//AI AVAILABLE OPTIONS

| T <sub>A</sub> | V <sub>IOmax</sub><br>AT 25°C | PACKAGED DEVICES         |                          |                            |
|----------------|-------------------------------|--------------------------|--------------------------|----------------------------|
|                |                               | SMALL OUTLINE<br>(D)     | PLASTIC DIP<br>(N)       | TSSOP<br>(PW)              |
| 0°C to 70°C    | 2000 μV                       | TLV2464CD<br>TLV2465CD   | TLV2464CN<br>TLV2465CN   | TLV2464CPW<br>TLV2465CPW   |
| -40°C to 125°C | 2000 μV                       | TLV2464ID<br>TLV2465ID   | TLV2464IN<br>TLV2465IN   | TLV2464IPW<br>TLV2465IPW   |
|                | 1500 μV                       | TLV2464AID<br>TLV2465AID | TLV2464AIN<br>TLV2465AIN | TLV2464AIPW<br>TLV2465AIPW |

† This package is available taped and reeled. To order this packaging option, add an R suffix to the part number (e.g., TLV2464CDR).

‡ Chip forms are tested at T<sub>A</sub> = 25°C only.

## TLV2464M/AM/Q/AQ and TLV2465M/AM/Q/AQ AVAILABLE OPTIONS

| T <sub>A</sub> | V <sub>IOmax</sub><br>AT 25°C | PACKAGED DEVICES         |                            |                          |                            |
|----------------|-------------------------------|--------------------------|----------------------------|--------------------------|----------------------------|
|                |                               | SMALL<br>OUTLINE†<br>(D) | SMALL<br>OUTLINE†<br>(PW)  | CERAMIC DIP<br>(J)       | CHIP CARRIER<br>(FK)       |
| -40°C to 125°C | 2000 μV                       | TLV2464QD<br>TLV2465QD   | TLV2464QPW<br>TLV2465QPW   | —<br>—                   | —<br>—                     |
|                | 1500 μV                       | TLV2464AQD<br>TLV2465AQD | TLV2464AQPW<br>TLV2465AQPW | —<br>—                   | —<br>—                     |
| -55°C to 125°C | 2000 μV                       | —<br>—                   | —<br>—                     | TLV2464MJ<br>TLV2465MJ   | TLV2464MFK<br>TLV2465MFK   |
|                | 1500 μV                       | —<br>—                   | —<br>—                     | TLV2464AMJ<br>TLV2465AMJ | TLV2464AMFK<br>TLV2465AMFK |

† This package is available taped and reeled. To order this packaging option, add an R suffix to the part number (e.g., TLV2464QDR).

# TLV2460, TLV2461, TLV2462, TLV2463, TLV2464, TLV2465, TLV246xA FAMILY OF LOW-POWER RAIL-TO-RAIL INPUT/OUTPUT OPERATIONAL AMPLIFIERS WITH SHUTDOWN

SLOS220J – JULY 1998 – REVISED FEBRUARY 2004

## TLV246x PACKAGE PINOUTS(1)

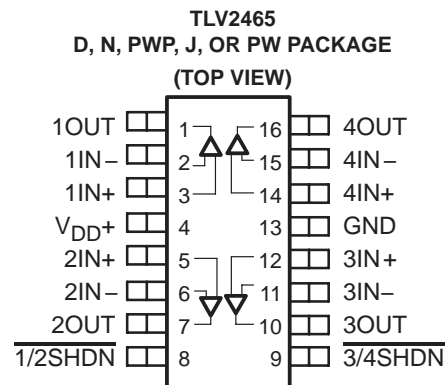
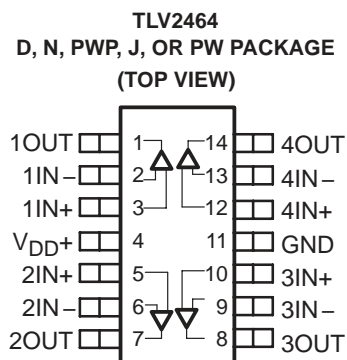
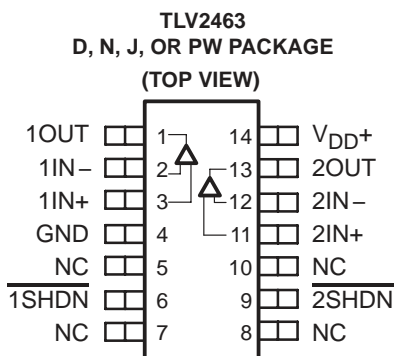
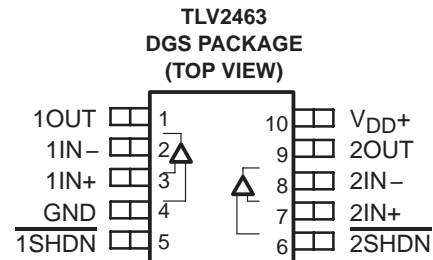
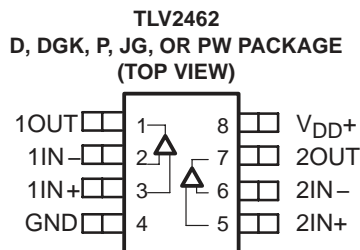
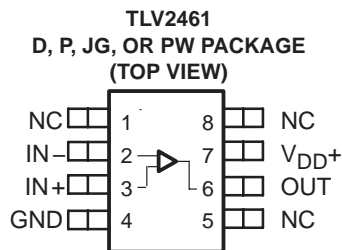
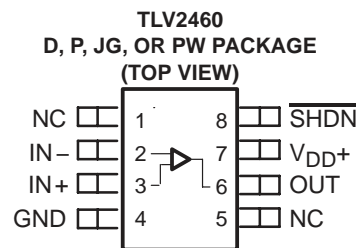
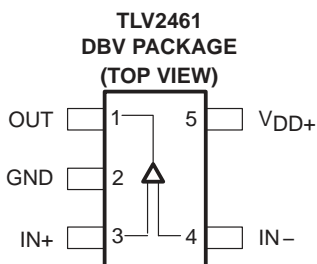
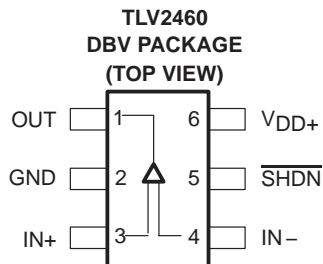

NC – No internal connection  
(1) SOT-23 may or may not be indicated

### TYPICAL PIN 1 INDICATORS

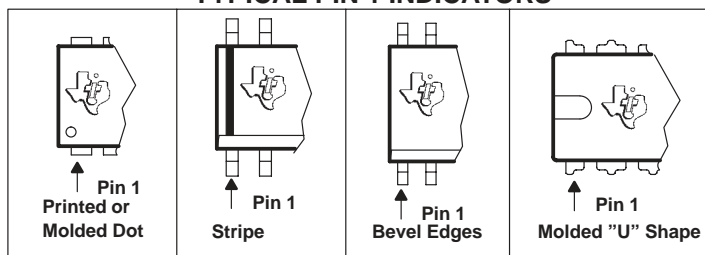

# TLV2460, TLV2461, TLV2462, TLV2463, TLV2464, TLV2465, TLV246xA FAMILY OF LOW-POWER RAIL-TO-RAIL INPUT/OUTPUT OPERATIONAL AMPLIFIERS WITH SHUTDOWN

SLOS220J – JULY 1998 – REVISED FEBRUARY 2004

## TLV246x PACKAGE PINOUTS (continued)(1)

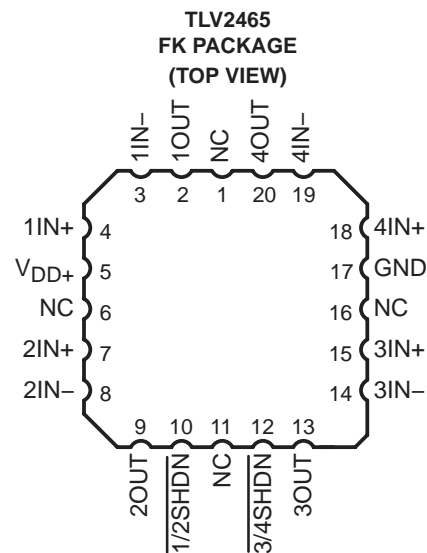
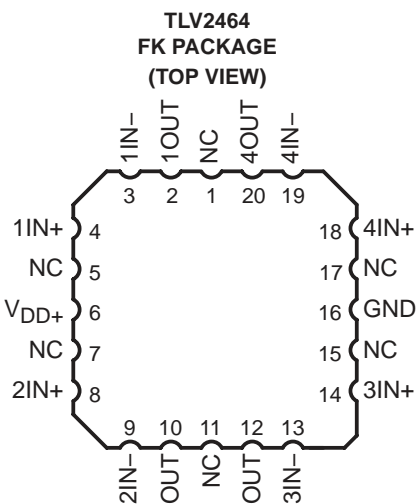
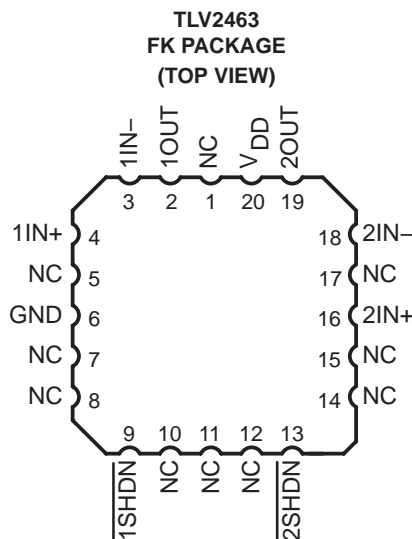
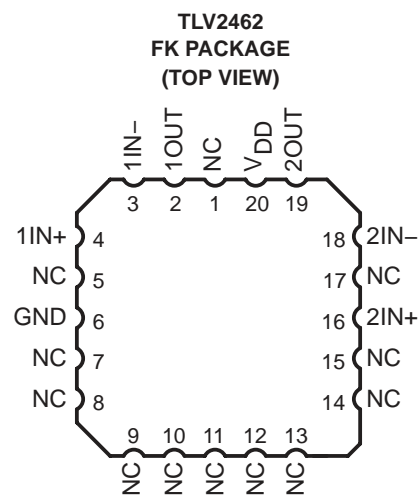
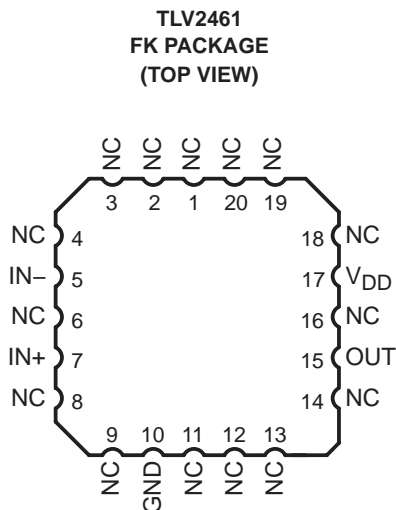
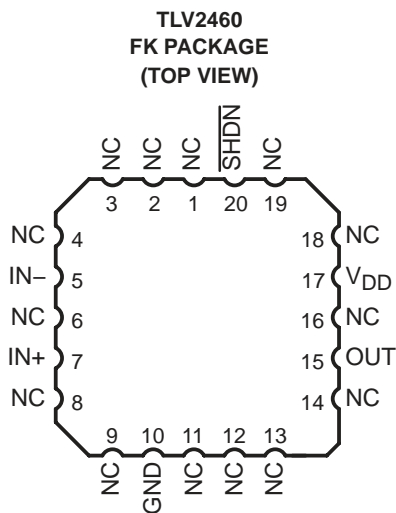
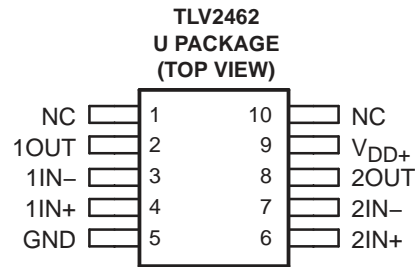
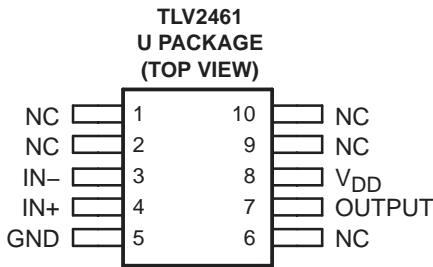
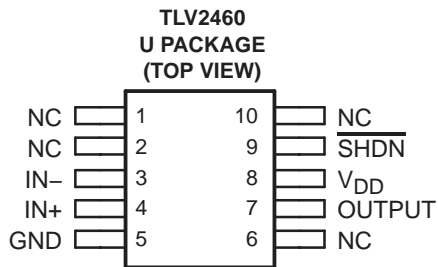

NC – No internal connection  
(1) SOT-23 may or may not be indicated

# TLV2460, TLV2461, TLV2462, TLV2463, TLV2464, TLV2465, TLV246xA

## FAMILY OF LOW-POWER RAIL-TO-RAIL INPUT/OUTPUT OPERATIONAL AMPLIFIERS WITH SHUTDOWN

SLOS220J – JULY 1998 – REVISED FEBRUARY 2004

### absolute maximum ratings over operating free-air temperature range (unless otherwise noted)†

|  |                              |
|--|------------------------------|
| Supply voltage, $V_{DD}$ (see Note 1)                        | 6 V                          |
| Differential input voltage, $V_{ID}$                         | – 0.2 V to $V_{DD} + 0.2$ V  |
| Input current, $I_I$ (any input)                             | ± 200 mA                     |
| Output current, $I_O$  | ± 175 mA                     |
| Total input current, $I_I$ (into $V_{DD+}$ )                 | 175 mA                       |
| Total output current, $I_O$ (out of GND)                     | 175 mA                       |
| Continuous total power dissipation                           | See Dissipation Rating Table |
| Operating free-air temperature range, $T_A$ : C suffix       | 0°C to 70°C                  |
| I and Q suffix   | –40°C to 125°C               |
| M suffix   | –55°C to 125°C               |
| Maximum junction temperature, $T_J$                          | 150°C                        |
| Storage temperature range, $T_{stg}$                         | –65°C to 150°C               |
| Lead temperature 1,6 mm (1/16 inch) from case for 10 seconds | 260°C                        |

† Stresses beyond those listed under “absolute maximum ratings” may cause permanent damage to the device. These are stress ratings only, and functional operation of the device at these or any other conditions beyond those indicated under “recommended operating conditions” is not implied. Exposure to absolute-maximum-rated conditions for extended periods may affect device reliability.

NOTE 1: All voltage values, except differential voltages, are with respect to GND.

DISSIPATION RATING TABLE FOR C and I SUFFIX

| PACKAGE    | $\theta_{JC}$<br>(°C/W) | $\theta_{JA}$<br>(°C/W) | $T_A \leq 25^\circ\text{C}$<br>POWER RATING | $T_A < 125^\circ\text{C}$<br>POWER RATING |
|------------|-------------------------|-------------------------|---|---|
| D (8)      | 38.3                    | 176                     | 710 mW                                      | 142 mW                                    |
| D (14)     | 26.9                    | 122.6                   | 1022 mW                                     | 204.4 mW                                  |
| D (16)     | 25.7                    | 114.7                   | 1090 mW                                     | 218 mW                                    |
| DBV (5)    | 55                      | 324.1                   | 385 mW                                      | 77.1 mW                                   |
| DBV (6)    | 55                      | 294.3                   | 425 mW                                      | 84.9 mW                                   |
| DGK        | 54.2                    | 259.9                   | 481 mW                                      | 96.2 mW                                   |
| DGS        | 54.1                    | 257.7                   | 485 mW                                      | 97 mW                                     |
| N (14, 16) | 32                      | 78                      | 1600 mW                                     | 320.5 mW                                  |
| P (8)      | 41                      | 104                     | 1200 mW                                     | 240.4 mW                                  |
| PW (14)    | 29.3                    | 173.6                   | 720 mW                                      | 144 mW                                    |
| PW (16)    | 28.7                    | 161.4                   | 774 mW                                      | 154.9 mW                                  |

NOTE: Thermal resistances are not production tested and are for informational purposes only.

DISSIPATION RATING TABLE FOR Q and M SUFFIX

| PACKAGE | $T_A \leq 25^\circ\text{C}$<br>POWER RATING | DERATING FACTOR<br>ABOVE $T_A = 25^\circ\text{C}^\ddagger$ | $T_A = 70^\circ\text{C}$<br>POWER RATING | $T_A = 85^\circ\text{C}$<br>POWER RATING | $T_A = 125^\circ\text{C}$<br>POWER RATING |
|---------|---|--|--|--|---|
| FK      | 1375 mW                                     | 11.0 mW/°C   | 880 mW                                   | 715 mW                                   | 275 mW                                    |
| JG      | 1050 mW                                     | 8.4 mW/°C  | 672 mW                                   | 546 mW                                   | 210 mW                                    |
| U       | 675 mW                                      | 5.4 mW/°C  | 432 mW                                   | 350 mW                                   | 135 mW                                    |

‡ This is the inverse of the traditional junction-to-ambient thermal resistance ( $R\theta_{JA}$ ). Thermal resistances are not production tested and are for informational purposes only.

# TLV2460, TLV2461, TLV2462, TLV2463, TLV2464, TLV2465, TLV246xA

## FAMILY OF LOW-POWER RAIL-TO-RAIL INPUT/OUTPUT OPERATIONAL AMPLIFIERS WITH SHUTDOWN

SLOS220J – JULY 1998 – REVISED FEBRUARY 2004

### recommended operating conditions

|  |                       | MIN        | MAX      | UNIT |
|--|-----------------------|------------|----------|------|
| Supply voltage, $V_{DD}$                   | Single supply         | 2.7        | 6        | V    |
|  | Split supply          | $\pm 1.35$ | $\pm 3$  |      |
| Common-mode input voltage range, $V_{ICR}$ |                       | 0          | $V_{DD}$ | V    |
| Operating free-air temperature, $T_A$      | C-suffix              | 0          | 70       | °C   |
|  | I-suffix and Q-suffix | -40        | 125      |      |
|  | M-suffix              | -55        | 125      |      |
| Shutdown on/off voltage level <sup>‡</sup> | $V_{IH}$              | 2          |          | V    |
|  | $V_{IL}$              |            | 0.7      |      |

<sup>‡</sup> Relative to voltage on the GND terminal of the device.

### electrical characteristics at specified free-air temperature, $V_{DD} = 3\text{ V}$ (unless otherwise noted)

| PARAMETER   | TEST CONDITIONS  | $T_A$ <sup>†</sup> | MIN | TYP      | MAX  | UNIT                         |
|---|--|--------------------|-----|----------|------|------------------------------|
| $V_{IO}$ Input offset voltage                                     | $V_{DD} = 3\text{ V}$ ,<br>$V_{IC} = 1.5\text{ V}$ ,<br>$V_O = 1.5\text{ V}$ ,<br>$R_S = 50\ \Omega$ | 25°C               |     | 500      | 2000 | $\mu\text{V}$                |
|   |  | Full range         |     |          | 2200 |                              |
|   |  | 25°C               |     | 500      | 1500 |                              |
|   |  | Full range         |     |          | 1700 |                              |
| $\alpha_{V_{IO}}$ Temperature coefficient of input offset voltage |  |                    |     | 2        |      | $\mu\text{V}/^\circ\text{C}$ |
| $I_{IO}$ Input offset current                                     | $V_{DD} = 3\text{ V}$ ,<br>$V_{IC} = 1.5\text{ V}$ ,<br>$V_O = 1.5\text{ V}$ ,<br>$R_S = 50\ \Omega$ | 25°C               |     | 2.8      | 7    | nA                           |
|   |  | Full range         |     |          | 20   |                              |
| $I_{IB}$ Input bias current                                       | $V_{DD} = 3\text{ V}$ ,<br>$V_{IC} = 1.5\text{ V}$ ,<br>$V_O = 1.5\text{ V}$ ,<br>$R_S = 50\ \Omega$ | 25°C               |     | 4.4      | 14   | nA                           |
|   |  | Full range         |     |          | 25   |                              |
| $V_{OH}$ High-level output voltage                                | $I_{OH} = -2.5\text{ mA}$  | 25°C               |     | 2.9      |      | V                            |
|   |  | Full range         |     | 2.8      |      |                              |
|   | $I_{OH} = -10\text{ mA}$   | 25°C               |     | 2.7      |      |                              |
|   |  | Full range         |     | 2.5      |      |                              |
| $V_{OL}$ Low-level output voltage                                 | $V_{IC} = 1.5\text{ V}$ , $I_{OL} = 2.5\text{ mA}$   | 25°C               |     | 0.1      |      | V                            |
|   |  | Full range         |     |          | 0.2  |                              |
|   | $V_{IC} = 1.5\text{ V}$ , $I_{OL} = 10\text{ mA}$  | 25°C               |     | 0.3      |      |                              |
|   |  | Full range         |     |          | 0.5  |                              |
| $I_{OS}$ Short-circuit output current                             | Sourcing   | 25°C               |     | 50       |      | mA                           |
|   |  | Full range         |     | 20       |      |                              |
|   | Sinking  | 25°C               |     | 40       |      |                              |
|   |  | Full range         |     | 20       |      |                              |
| $I_O$ Output current  | Measured 1 V from rail   | 25°C               |     | $\pm 40$ |      | mA                           |
| $A_{VD}$ Large-signal differential voltage amplification          | $R_L = 10\text{ k}\Omega$ , $V_O(PP) = 1\text{ V}$   | 25°C               |     | 90       | 105  | dB                           |
|   |  | Full range         |     | 89       |      |                              |
| $r_{i(d)}$ Differential input resistance                          |  | 25°C               |     | $10^9$   |      | $\Omega$                     |

<sup>†</sup> Full range is 0°C to 70°C for the C suffix, -40°C to 125°C for the I and Q suffixes, and -55°C to 125°C for the M suffix.

# TLV2460, TLV2461, TLV2462, TLV2463, TLV2464, TLV2465, TLV246xA

## FAMILY OF LOW-POWER RAIL-TO-RAIL INPUT/OUTPUT OPERATIONAL AMPLIFIERS WITH SHUTDOWN

SLOS220J – JULY 1998 – REVISED FEBRUARY 2004

electrical characteristics at specified free-air temperature,  $V_{DD} = 3\text{ V}$  (unless otherwise noted)  
(continued)

| PARAMETER      |   | TEST CONDITIONS   |                       | $T_A^\dagger$      | MIN        | TYP | MAX   | UNIT          |
|----------------|---|---|-----------------------|--------------------|------------|-----|-------|---------------|
| $C_i(c)$       | Common-mode input capacitance   | $f = 10\text{ kHz}$   |                       | $25^\circ\text{C}$ |            | 7   |       | pF            |
| $Z_o$          | Closed-loop output impedance  | $f = 100\text{ kHz}$ ,  | $A_V = 10$            | $25^\circ\text{C}$ |            | 33  |       | $\Omega$      |
| CMRR           | Common-mode rejection ratio   | $V_{ICR} = 0\text{ to }3\text{ V}$ ,<br>$R_S = 50\ \Omega$    |                       | $25^\circ\text{C}$ | 66         | 80  |       | dB            |
|                |   |   |                       | TLV246xC           | Full range | 64  |       |               |
|                |   |   |                       | TLV246xI/Q/M       | Full range | 60  |       |               |
| $k_{SVR}$      | Supply voltage rejection ratio<br>( $\Delta V_{DD} / \Delta V_{IO}$ ) | $V_{DD} = 2.7\text{ V to }6\text{ V}$ ,<br>No load            | $V_{IC} = V_{DD}/2$ , | $25^\circ\text{C}$ | 80         | 85  |       | dB            |
|                |   |   |                       | Full range         | 75         |     |       |               |
|                |   |   |                       | $25^\circ\text{C}$ | 85         | 95  |       |               |
|                |   |   |                       | Full range         | 80         |     |       |               |
| $I_{DD}$       | Supply current (per channels)   | $V_O = 1.5\text{ V}$ ,  | No load               | $25^\circ\text{C}$ |            | 0.5 | 0.575 | mA            |
|                |   |   |                       | Full range         |            |     | 0.9   |               |
| $I_{DD}(SHDN)$ | Supply current in shutdown<br>(TLV2460, TLV2463, TLV2465)             | $\overline{SHDN} < 0.7\text{ V}$ ,<br>Per channel in shutdown |                       | $25^\circ\text{C}$ |            | 0.3 |       | $\mu\text{A}$ |
|                |   |   |                       | Full range         |            |     | 2.5   |               |

$\dagger$  Full range is  $0^\circ\text{C}$  to  $70^\circ\text{C}$  for the C suffix,  $-40^\circ\text{C}$  to  $125^\circ\text{C}$  for the I and Q suffixes, and  $-55^\circ\text{C}$  to  $125^\circ\text{C}$  for the M suffix.

operating characteristics at specified free-air temperature,  $V_{DD} = 3\text{ V}$  (unless otherwise noted)

| PARAMETER              |                                      | TEST CONDITIONS   |                             | $T_A^\dagger$                   | MIN                | TYP    | MAX | UNIT                         |
|------------------------|--------------------------------------|---|-----------------------------|---------------------------------|--------------------|--------|-----|------------------------------|
| SR                     | Slew rate at unity gain              | $V_{O(PP)} = 0.8\text{ V}$ ,<br>$R_L = 10\text{ k}\Omega$   | $C_L = 160\text{ pF}$ ,     | $25^\circ\text{C}$              | 0.9                | 1.6    |     | $\text{V}/\mu\text{s}$       |
|                        |                                      |   |                             | Full range                      | 0.8                |        |     |                              |
| $V_n$                  | Equivalent input noise voltage       | $f = 100\text{ Hz}$   |                             | $25^\circ\text{C}$              |                    | 16     |     | $\text{nV}/\sqrt{\text{Hz}}$ |
|                        |                                      | $f = 1\text{ kHz}$  |                             | $25^\circ\text{C}$              |                    | 11     |     |                              |
| $I_n$                  | Equivalent input noise current       | $f = 1\text{ kHz}$  |                             | $25^\circ\text{C}$              |                    | 0.13   |     | $\text{pA}/\sqrt{\text{Hz}}$ |
| THD + N                | Total harmonic distortion plus noise | $V_{O(PP)} = 2\text{ V}$ ,<br>$R_L = 10\text{ k}\Omega$ , $f = 1\text{ kHz}$                      |                             | $25^\circ\text{C}$              |                    | 0.006% |     |                              |
|                        |                                      |   |                             | $A_V = 1$                       |                    | 0.02%  |     |                              |
|                        |                                      |   |                             | $A_V = 10$                      |                    | 0.08%  |     |                              |
| $t_{(on)}$             | Amplifier turnon time                | $A_V = 1$ , $R_L = 10\text{ k}\Omega$   |                             | Both channels                   | $25^\circ\text{C}$ | 7.6    |     | $\mu\text{s}$                |
|                        |                                      |   |                             | Channel 1 only,<br>Channel 2 on |                    | 7.65   |     |                              |
| $t_{(off)}$            | Amplifier turnoff time               | $A_V = 1$ , $R_L = 10\text{ k}\Omega$   |                             | Both channels                   | $25^\circ\text{C}$ | 333    |     | ns                           |
|                        |                                      |   |                             | Channel 1 only,<br>Channel 2 on |                    | 328    |     |                              |
|                        |                                      |   |                             | Channel 2 only,<br>Channel 1 on |                    | 329    |     |                              |
| Gain-bandwidth product |                                      | $f = 10\text{ kHz}$ , $C_L = 160\text{ pF}$   | $R_L = 10\text{ k}\Omega$ , | $25^\circ\text{C}$              |                    | 5.2    |     | MHz                          |
| $t_s$                  | Settling time                        | $V_{(STEP)PP} = 2\text{ V}$ ,<br>$A_V = -1$ , $C_L = 10\text{ pF}$ ,<br>$R_L = 10\text{ k}\Omega$ |                             | $25^\circ\text{C}$              |                    | 1.47   |     | $\mu\text{s}$                |
|                        |                                      |   |                             | 0.01%                           |                    | 1.78   |     |                              |
|                        |                                      | $V_{(STEP)PP} = 2\text{ V}$ ,<br>$A_V = -1$ , $C_L = 56\text{ pF}$ ,<br>$R_L = 10\text{ k}\Omega$ |                             | $25^\circ\text{C}$              |                    | 1.77   |     |                              |
|                        |                                      |   |                             | 0.01%                           |                    | 1.98   |     |                              |
| $\phi_m$               | Phase margin at unity gain           | $R_L = 10\text{ k}\Omega$ ,   | $C_L = 160\text{ pF}$       | $25^\circ\text{C}$              |                    | 44°    |     |                              |
|                        | Gain margin                          |   |                             | $25^\circ\text{C}$              |                    | 7      |     | dB                           |

$\dagger$  Full range is  $0^\circ\text{C}$  to  $70^\circ\text{C}$  for the C suffix,  $-40^\circ\text{C}$  to  $125^\circ\text{C}$  for the I and Q suffixes, and  $-55^\circ\text{C}$  to  $125^\circ\text{C}$  for the M suffix.



# TLV2460, TLV2461, TLV2462, TLV2463, TLV2464, TLV2465, TLV246xA

## FAMILY OF LOW-POWER RAIL-TO-RAIL INPUT/OUTPUT OPERATIONAL AMPLIFIERS WITH SHUTDOWN

SLOS220J – JULY 1998 – REVISED FEBRUARY 2004

electrical characteristics at specified free-air temperature,  $V_{DD} = 5\text{ V}$  (unless otherwise noted)

| PARAMETER  | TEST CONDITIONS  | $T_A$ †                   | MIN          | TYP      | MAX  | UNIT                         |
|--|--|---------------------------|--------------|----------|------|------------------------------|
| $V_{IO}$ Input offset voltage  | $V_{DD} = 5\text{ V}$ ,<br>$V_{IC} = 2.5\text{ V}$ ,<br>$V_O = 2.5\text{ V}$ ,<br>$R_S = 50\ \Omega$ | 25°C                      |              | 500      | 2000 | $\mu\text{V}$                |
|  |  | Full range                |              |          | 2200 |                              |
|  |  | 25°C                      | TLV246xA     | 500      | 1500 |                              |
|  |  | Full range                | TLV246xA     |          | 1700 |                              |
| $\alpha_{VIO}$ Temperature coefficient of input offset voltage               |  | 25°C                      |              | 2        |      | $\mu\text{V}/^\circ\text{C}$ |
| $I_{IO}$ Input offset current  | $V_{DD} = 5\text{ V}$ ,<br>$V_{IC} = 2.5\text{ V}$ ,<br>$V_O = 2.5\text{ V}$ ,<br>$R_S = 50\ \Omega$ | 25°C                      |              | 0.3      | 7    | nA                           |
|  |  | Full range                | TLV246xC     |          | 15   |                              |
|  |  | Full range                | TLV246xI/Q/M |          | 60   |                              |
| $I_{IB}$ Input bias current  | $V_{DD} = 5\text{ V}$ ,<br>$V_{IC} = 2.5\text{ V}$ ,<br>$V_O = 2.5\text{ V}$ ,<br>$R_S = 50\ \Omega$ | 25°C                      |              | 1.3      | 14   | nA                           |
|  |  | Full range                | TLV246xC     |          | 30   |                              |
|  |  | Full range                | TLV246xI/Q/M |          | 60   |                              |
| $V_{OH}$ High-level output voltage   | $I_{OH} = -2.5\text{ mA}$  | 25°C                      |              | 4.9      |      | V                            |
|  |  | Full range                |              | 4.8      |      |                              |
|  | $I_{OH} = -10\text{ mA}$   | 25°C                      |              | 4.8      |      |                              |
|  |  | Full range                |              | 4.7      |      |                              |
| $V_{OL}$ Low-level output voltage  | $V_{IC} = 2.5\text{ V}$ ,<br>$I_{OL} = 2.5\text{ mA}$  | 25°C                      |              | 0.1      |      | V                            |
|  |  | Full range                |              |          | 0.2  |                              |
|  | $V_{IC} = 2.5\text{ V}$ ,<br>$I_{OL} = 10\text{ mA}$   | 25°C                      |              | 0.2      |      |                              |
|  |  | Full range                |              |          | 0.3  |                              |
| $I_{OS}$ Short-circuit output current  | Sourcing   | 25°C                      |              | 145      |      | mA                           |
|  |  | Full range                |              | 60       |      |                              |
|  | Sinking  | 25°C                      |              | 100      |      |                              |
|  |  | Full range                |              | 60       |      |                              |
| $I_O$ Output current   | Measured at 1 V from rail  | 25°C                      |              | $\pm 80$ |      | mA                           |
| $A_{VD}$ Large-signal differential voltage amplification                     | $V_{IC} = 2.5\text{ V}$ ,<br>$V_O = 1\text{ V to }4\text{ V}$  | $R_L = 10\text{ k}\Omega$ | 25°C         | 92       | 109  | dB                           |
|  |  |                           | Full range   | 90       |      |                              |
| $r_{i(d)}$ Differential input resistance                                     |  | 25°C                      |              | $10^9$   |      | $\Omega$                     |
| $c_{i(c)}$ Common-mode input capacitance                                     | $f = 10\text{ kHz}$  | 25°C                      |              | 7        |      | pF                           |
| $z_o$ Closed-loop output impedance   | $f = 100\text{ kHz}$ ,<br>$A_V = 10$   | 25°C                      |              | 29       |      | $\Omega$                     |
| CMRR Common-mode rejection ratio   | $V_{ICR} = 0\text{ V to }5\text{ V}$ ,<br>$R_S = 50\ \Omega$   | 25°C                      |              | 71       | 85   | dB                           |
|  |  | Full range                | TLV246xC     | 69       |      |                              |
|  |  | Full range                | TLV246xI/Q/M | 60       |      |                              |
| $k_{SVR}$ Supply voltage rejection ratio ( $\Delta V_{DD} / \Delta V_{IO}$ ) | $V_{DD} = 2.7\text{ V to }6\text{ V}$ ,<br>No load   | $V_{IC} = V_{DD}/2$       | 25°C         | 80       | 85   | dB                           |
|  |  |                           | Full range   |          | 75   |                              |
|  | $V_{DD} = 3\text{ V to }5\text{ V}$ ,<br>No load   | $V_{IC} = V_{DD}/2$       | 25°C         | 85       | 95   | dB                           |
|  |  |                           | Full range   |          | 80   |                              |
| $I_{DD}$ Supply current (per channel)  | $V_O = 2.5\text{ V}$ ,<br>No load,   | 25°C                      |              | 0.55     | 0.65 | mA                           |
|  |  | Full range                |              |          | 1    |                              |
| $I_{DD(SHDN)}$ Supply current in shutdown (TLV2460, TLV2463, TLV2465)        | $\overline{\text{SHDN}} < 0.7\text{ V}$ , Per channels in shutdown                                   | 25°C                      |              | 1        |      | $\mu\text{A}$                |
|  |  | Full range                |              |          | 3    |                              |

† Full range is 0°C to 70°C for the C suffix, -40°C to 125°C for the I and Q suffixes, and -55°C to 125°C for the M suffix.

# TLV2460, TLV2461, TLV2462, TLV2463, TLV2464, TLV2465, TLV246xA

## FAMILY OF LOW-POWER RAIL-TO-RAIL INPUT/OUTPUT OPERATIONAL AMPLIFIERS WITH SHUTDOWN

SLOS220J – JULY 1998 – REVISED FEBRUARY 2004

operating characteristics at specified free-air temperature,  $V_{DD} = 5\text{ V}$  (unless otherwise noted)

| PARAMETER              |                                      | TEST CONDITIONS  |                           | $T_A$ †    | MIN                             | TYP  | MAX | UNIT                         |
|------------------------|--------------------------------------|--|---------------------------|------------|---------------------------------|------|-----|------------------------------|
| SR                     | Slew rate at unity gain              | $V_{O(PP)} = 2\text{ V}$ ,<br>$R_L = 10\text{ k}\Omega$  | $C_L = 160\text{ pF}$     | 25°C       | 0.9                             | 1.6  |     | $\text{V}/\mu\text{s}$       |
|                        |                                      |  |                           | Full range | 0.8                             |      |     |                              |
| $V_n$                  | Equivalent input noise voltage       |  |                           | 25°C       |                                 | 14   |     | $\text{nV}/\sqrt{\text{Hz}}$ |
|                        |                                      |  |                           | 25°C       |                                 | 11   |     |                              |
| $I_n$                  | Equivalent input noise current       | $f = 100\text{ Hz}$  |                           | 25°C       |                                 | 0.13 |     | $\text{pA}/\sqrt{\text{Hz}}$ |
| THD + N                | Total harmonic distortion plus noise | $V_{O(PP)} = 4\text{ V}$ ,<br>$R_L = 10\text{ k}\Omega$ ,<br>$f = 10\text{ kHz}$                     |                           | 25°C       | $A_V = 1$                       |      |     |                              |
|                        |                                      |  |                           |            | $A_V = 10$                      |      |     |                              |
|                        |                                      |  |                           |            | $A_V = 100$                     |      |     |                              |
| $t_{(on)}$             | Amplifier turnon time                | $A_V = 1$ , $R_L = 10\text{ k}\Omega$  |                           | 25°C       | Both channels                   |      |     | $\mu\text{s}$                |
|                        |                                      |  |                           |            | Channel 1 only,<br>Channel 2 on |      |     |                              |
|                        |                                      |  |                           |            | Channel 2 only,<br>Channel 1 on |      |     |                              |
| $t_{(off)}$            | Amplifier turnoff time               | $A_V = 1$ , $R_L = 10\text{ k}\Omega$  |                           | 25°C       | Both channels                   |      |     | ns                           |
|                        |                                      |  |                           |            | Channel 1 only,<br>Channel 2 on |      |     |                              |
|                        |                                      |  |                           |            | Channel 2 only,<br>Channel 1 on |      |     |                              |
| Gain-bandwidth product |                                      | $f = 10\text{ kHz}$ ,<br>$C_L = 160\text{ pF}$   | $R_L = 10\text{ k}\Omega$ | 25°C       |                                 | 6.4  |     | MHz                          |
| $t_s$                  | Settling time                        | $V_{(STEP)PP} = 2\text{ V}$ ,<br>$A_V = -1$ ,<br>$C_L = 10\text{ pF}$ ,<br>$R_L = 10\text{ k}\Omega$ |                           | 25°C       | 0.1%                            |      |     | $\mu\text{s}$                |
|                        |                                      |  |                           |            | 0.01%                           |      |     |                              |
|                        |                                      | $V_{(STEP)PP} = 2\text{ V}$ ,<br>$A_V = -1$ ,<br>$C_L = 56\text{ pF}$ ,<br>$R_L = 10\text{ k}\Omega$ |                           |            | 0.1%                            |      |     |                              |
|                        |                                      |  |                           |            | 0.01%                           |      |     |                              |
| $\phi_m$               | Phase margin at unity gain           | $R_L = 10\text{ k}\Omega$ , $C_L = 160\text{ pF}$  |                           | 25°C       |                                 | 45°  |     |                              |
|                        | Gain margin                          |  |                           | 25°C       |                                 | 7    |     | dB                           |

† Full range is 0°C to 70°C for the C suffix, –40°C to 125°C for the I and Q suffixes, and –55°C to 125°C for the M suffix.

# TLV2460, TLV2461, TLV2462, TLV2463, TLV2464, TLV2465, TLV246xA FAMILY OF LOW-POWER RAIL-TO-RAIL INPUT/OUTPUT OPERATIONAL AMPLIFIERS WITH SHUTDOWN

SLOS220J – JULY 1998 – REVISED FEBRUARY 2004

## TYPICAL CHARACTERISTICS

### Table of Graphs

|             |                                      |                                  | FIGURE |
|-------------|--------------------------------------|----------------------------------|--------|
| $V_{IO}$    | Input offset voltage                 | vs Common-mode input voltage     | 1, 2   |
| $I_{IB}$    | Input bias current                   | vs Free-air temperature          | 3, 4   |
| $I_{IO}$    | Input offset current                 | vs Free-air temperature          | 3, 4   |
| $V_{OH}$    | High-level output voltage            | vs High-level output current     | 5, 6   |
| $V_{OL}$    | Low-level output voltage             | vs Low-level output current      | 7, 8   |
| $V_{O(PP)}$ | Peak-to-peak output voltage          | vs Frequency                     | 9, 10  |
|             | Open-loop gain                       | vs Frequency                     | 11, 12 |
|             | Phase                                | vs Frequency                     | 11, 12 |
| $A_{VD}$    | Differential voltage amplification   | vs Load resistance               | 13     |
|             | Capacitive load                      | vs Load resistance               | 14     |
| $Z_o$       | Output impedance                     | vs Frequency                     | 15, 16 |
| CMRR        | Common-mode rejection ratio          | vs Frequency                     | 17     |
| $k_{SVR}$   | Supply-voltage rejection ratio       | vs Frequency                     | 18, 19 |
| $I_{DD}$    | Supply current                       | vs Supply voltage                | 20     |
|             |                                      | vs Free-air temperature          | 21     |
|             | Amplifier turnon characteristics     |                                  | 22     |
|             | Amplifier turnoff characteristics    |                                  | 23     |
|             | Supply current turnon                |                                  | 24     |
|             | Supply current turnoff               |                                  | 25     |
|             | Shutdown supply current              | vs Free-air temperature          | 26     |
| SR          | Slew rate                            | vs Supply voltage                | 27     |
| $V_n$       | Equivalent input noise voltage       | vs Frequency                     | 28, 29 |
|             |                                      | vs Common-mode input voltage     | 30, 31 |
| THD         | Total harmonic distortion            | vs Frequency                     | 32, 33 |
| THD+N       | Total harmonic distortion plus noise | vs Peak-to-peak signal amplitude | 34, 35 |
| $\phi_m$    | Phase margin                         | vs Frequency                     | 11, 12 |
|             |                                      | vs Load capacitance              | 36     |
|             |                                      | vs Free-air temperature          | 37     |
|             | Gain bandwidth product               | vs Supply voltage                | 38     |
|             |                                      | vs Free-air temperature          | 39     |
|             | Large signal follower                |                                  | 40, 41 |
|             | Small signal follower                |                                  | 42, 43 |
|             | Inverting large signal               |                                  | 44, 45 |
|             | Inverting small signal               |                                  | 46, 47 |

**TLV2460, TLV2461, TLV2462, TLV2463, TLV2464, TLV2465, TLV246xA**  
**FAMILY OF LOW-POWER RAIL-TO-RAIL INPUT/OUTPUT**  
**OPERATIONAL AMPLIFIERS WITH SHUTDOWN**

SLOS220J – JULY 1998 – REVISED FEBRUARY 2004

**TYPICAL CHARACTERISTICS**

**INPUT OFFSET VOLTAGE**  
**vs**  
**COMMON-MODE INPUT VOLTAGE**

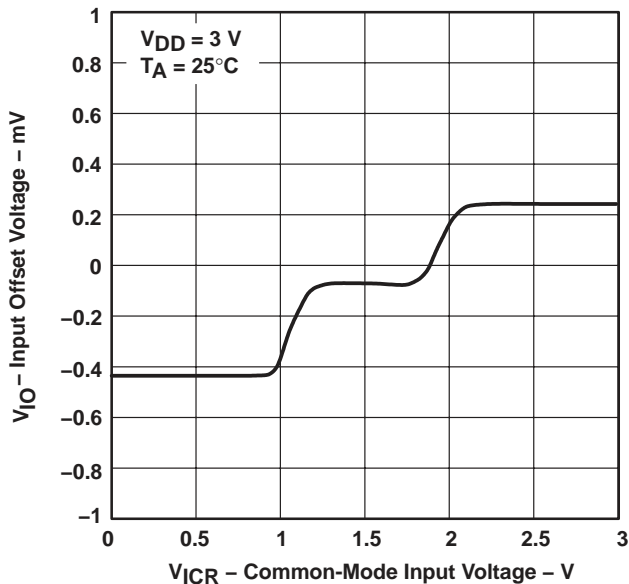

**Figure 1**

**INPUT OFFSET VOLTAGE**  
**vs**  
**COMMON-MODE INPUT VOLTAGE**

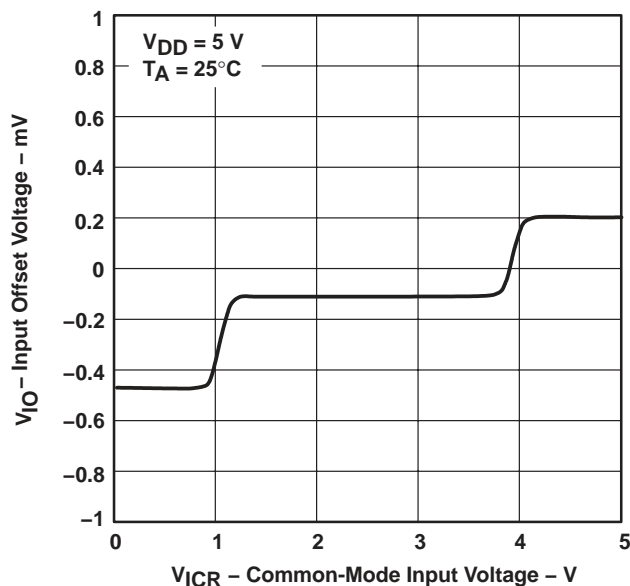

**Figure 2**

**INPUT BIAS AND INPUT OFFSET CURRENT**  
**vs**  
**FREE-AIR TEMPERATURE**

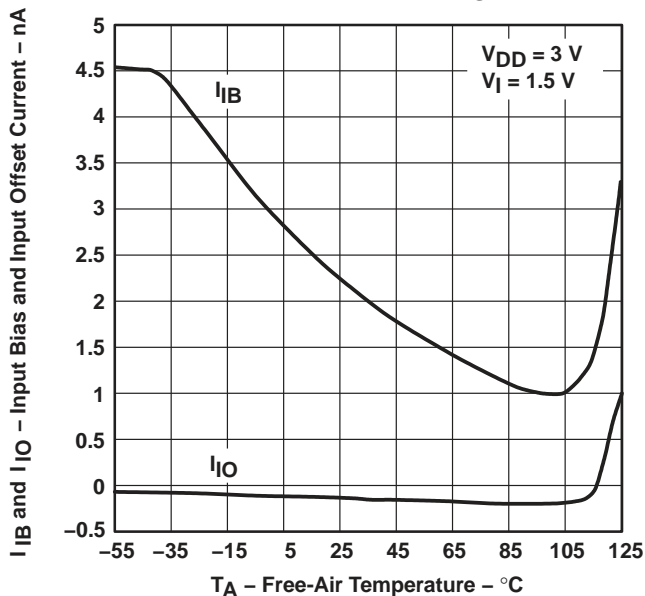

**Figure 3**

**INPUT BIAS AND INPUT OFFSET CURRENT**  
**vs**  
**FREE-AIR TEMPERATURE**

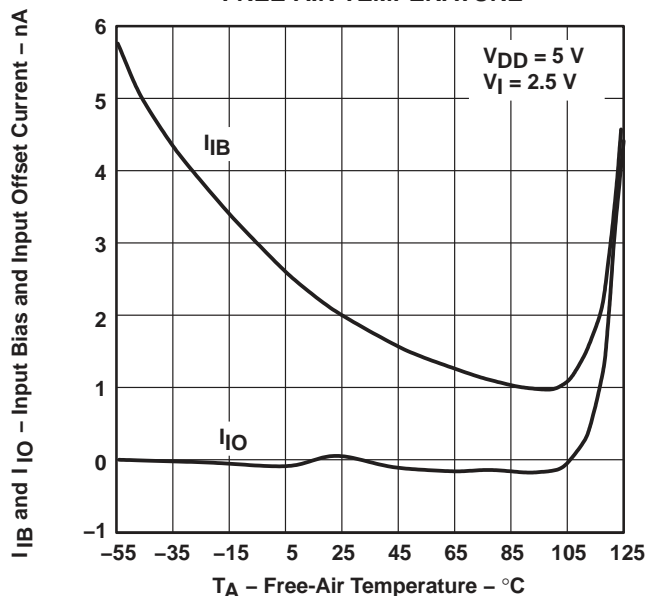

**Figure 4**

TLV2460, TLV2461, TLV2462, TLV2463, TLV2464, TLV2465, TLV246xA  
 FAMILY OF LOW-POWER RAIL-TO-RAIL INPUT/OUTPUT  
 OPERATIONAL AMPLIFIERS WITH SHUTDOWN

SLOS220J – JULY 1998 – REVISED FEBRUARY 2004

TYPICAL CHARACTERISTICS

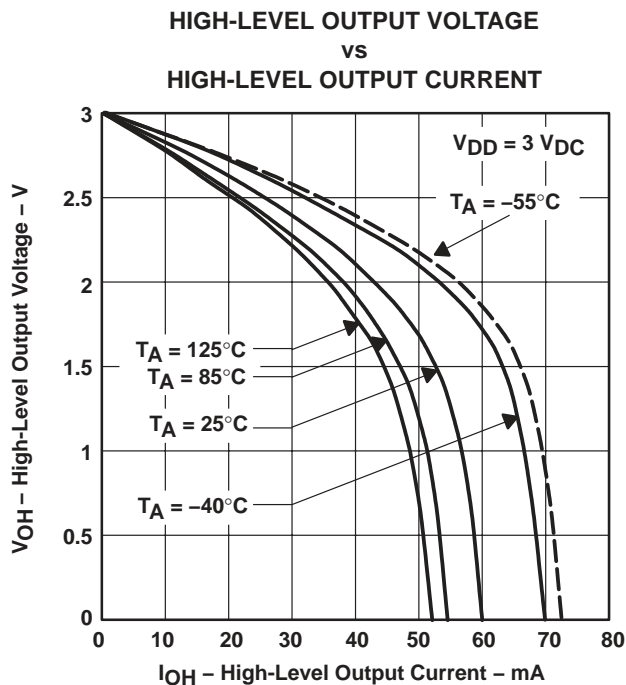

Figure 5

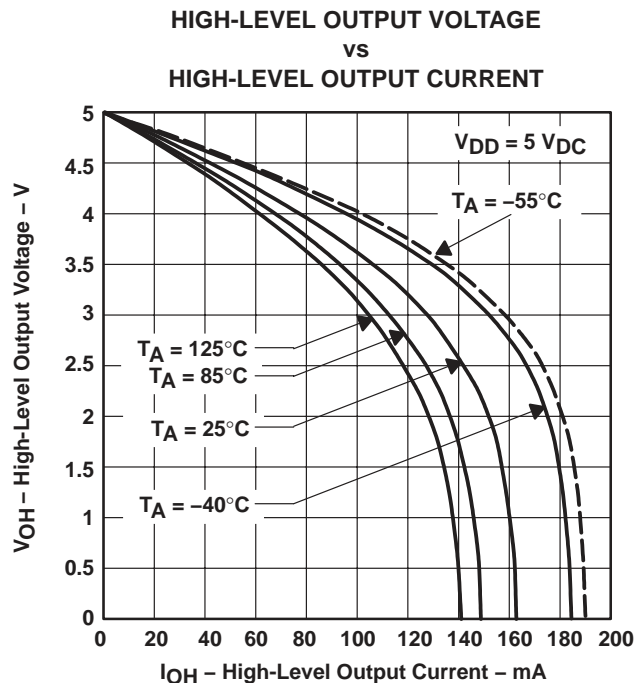

Figure 6

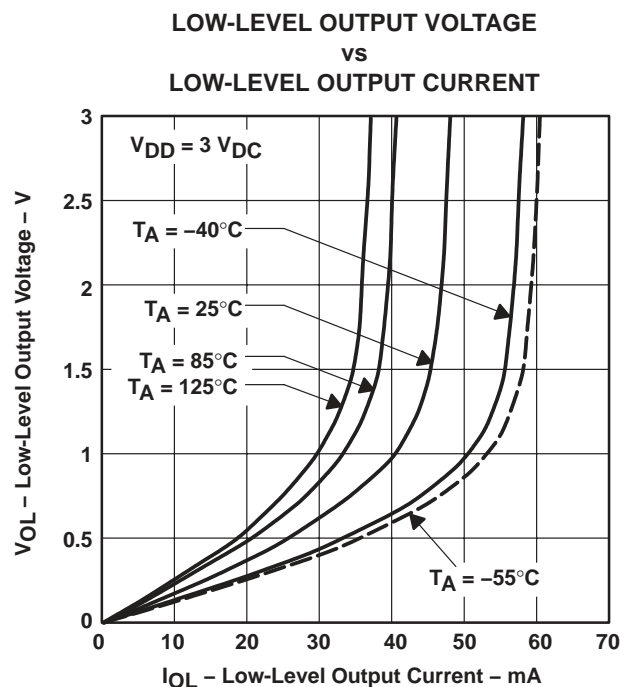

Figure 7

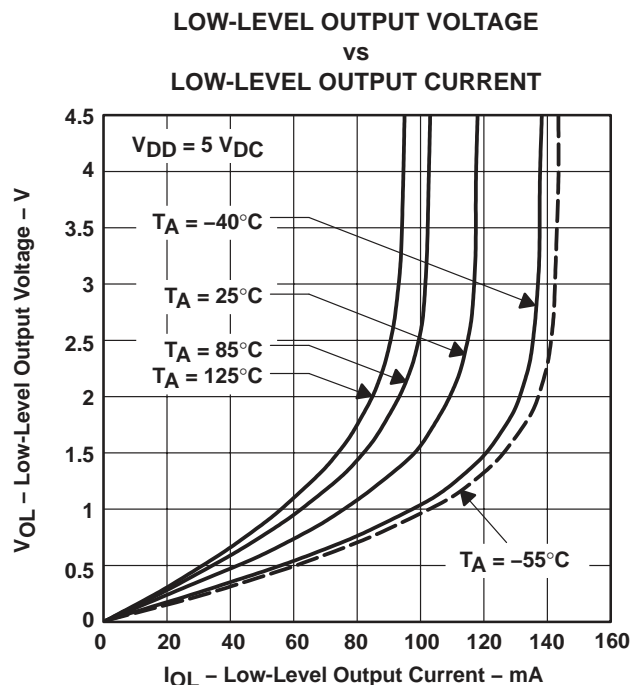

Figure 8

**TLV2460, TLV2461, TLV2462, TLV2463, TLV2464, TLV2465, TLV246xA**  
**FAMILY OF LOW-POWER RAIL-TO-RAIL INPUT/OUTPUT**  
**OPERATIONAL AMPLIFIERS WITH SHUTDOWN**

SLOS220J – JULY 1998 – REVISED FEBRUARY 2004

**TYPICAL CHARACTERISTICS**

**PEAK-TO-PEAK OUTPUT VOLTAGE**  
**VS**  
**FREQUENCY**

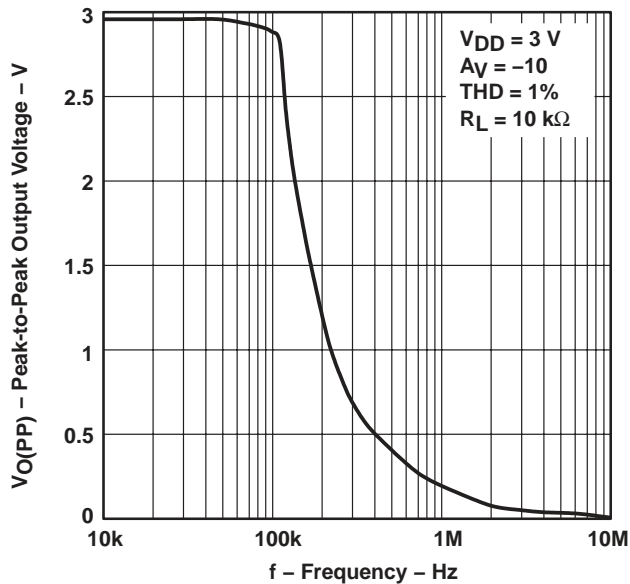

**Figure 9**

**PEAK-TO-PEAK OUTPUT VOLTAGE**  
**VS**  
**FREQUENCY**

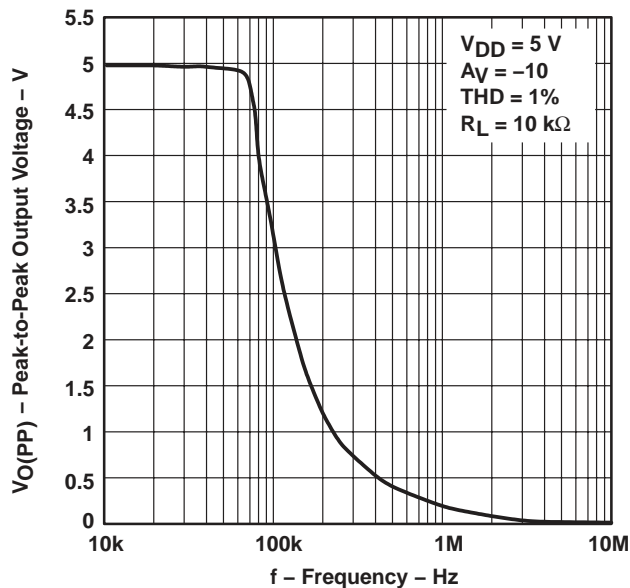

**Figure 10**

**OPEN-LOOP GAIN AND PHASE**  
**VS**  
**FREQUENCY**

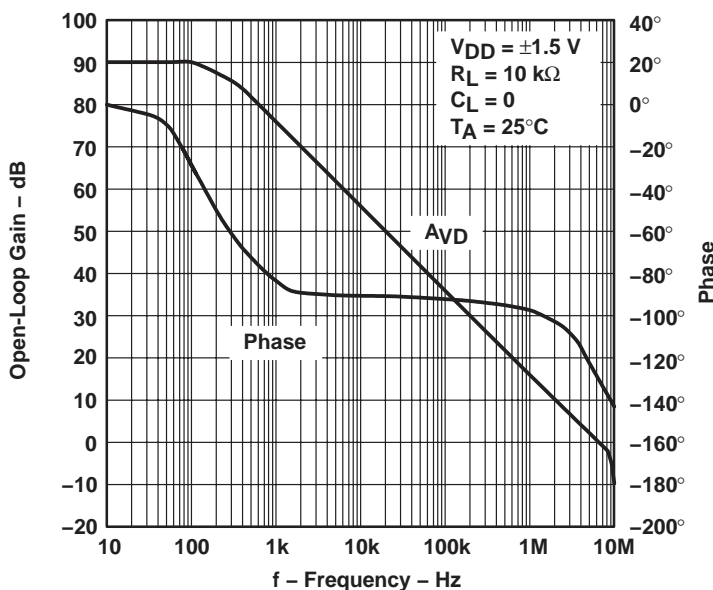

**Figure 11**

# TLV2460, TLV2461, TLV2462, TLV2463, TLV2464, TLV2465, TLV246xA FAMILY OF LOW-POWER RAIL-TO-RAIL INPUT/OUTPUT OPERATIONAL AMPLIFIERS WITH SHUTDOWN

SLOS220J – JULY 1998 – REVISED FEBRUARY 2004

## TYPICAL CHARACTERISTICS

### OPEN-LOOP GAIN AND PHASE vs FREQUENCY

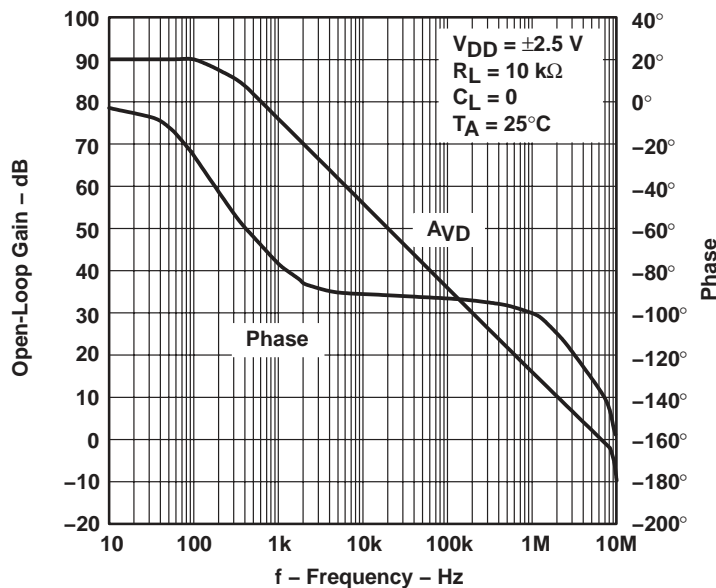

Figure 12

### DIFFERENTIAL VOLTAGE AMPLIFICATION vs LOAD RESISTANCE

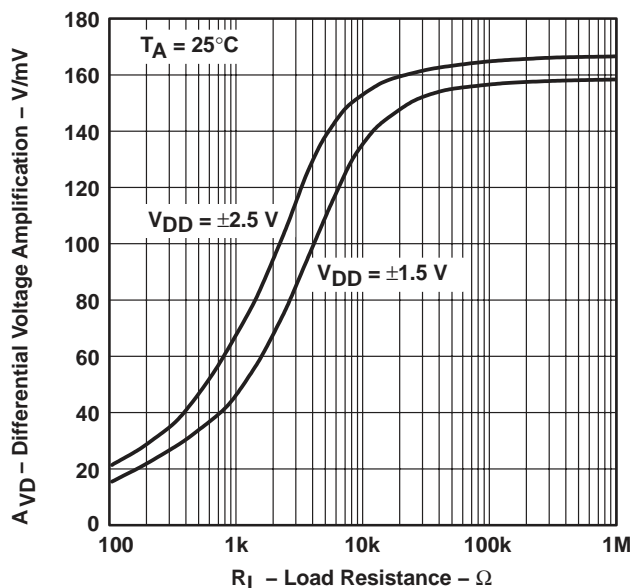

Figure 13

### CAPACITIVE LOAD vs LOAD RESISTANCE

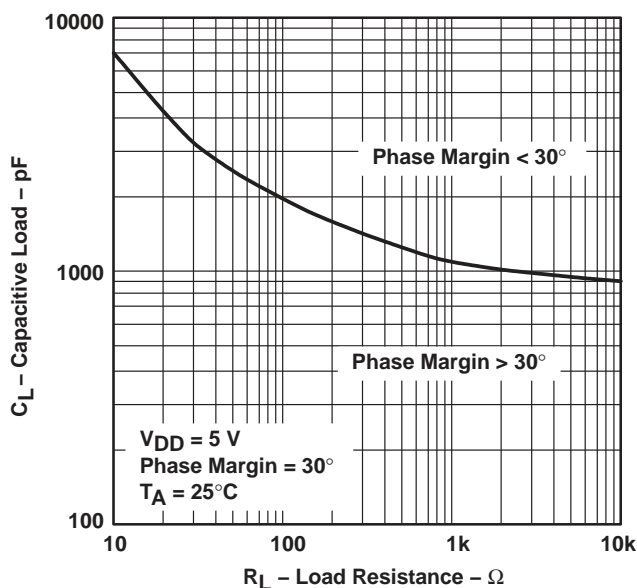

Figure 14

**TLV2460, TLV2461, TLV2462, TLV2463, TLV2464, TLV2465, TLV246xA**  
**FAMILY OF LOW-POWER RAIL-TO-RAIL INPUT/OUTPUT**  
**OPERATIONAL AMPLIFIERS WITH SHUTDOWN**

SLOS220J – JULY 1998 – REVISED FEBRUARY 2004

**TYPICAL CHARACTERISTICS**

**OUTPUT IMPEDANCE**  
**vs**  
**FREQUENCY**

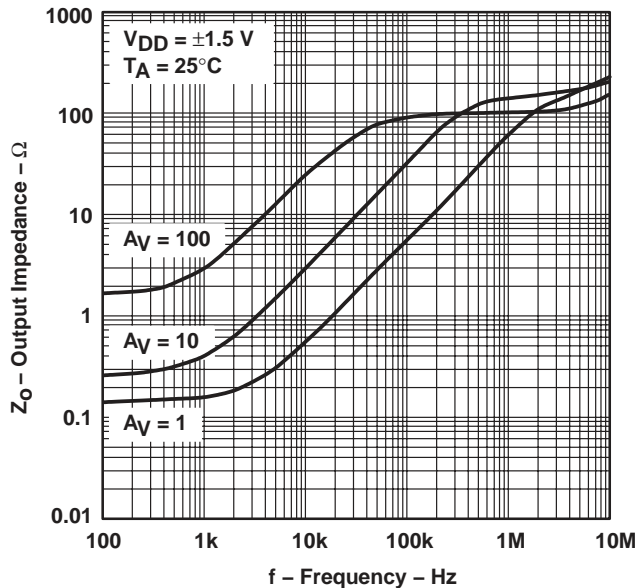

**Figure 15**

**OUTPUT IMPEDANCE**  
**vs**  
**FREQUENCY**

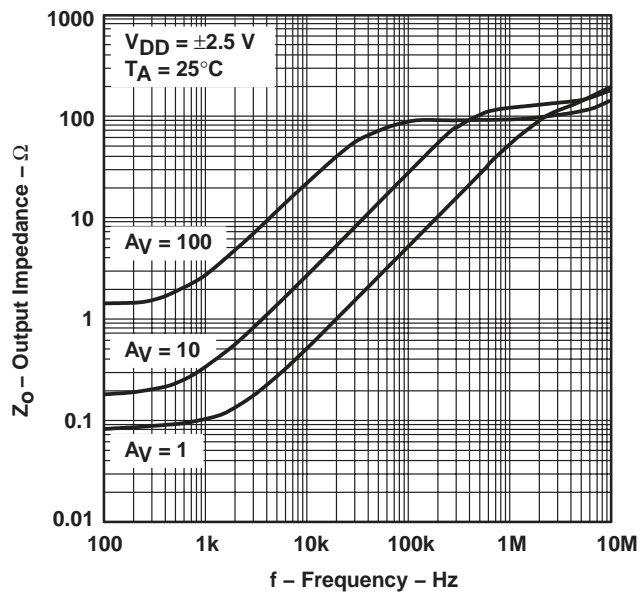

**Figure 16**

**COMMON-MODE REJECTION RATIO**  
**vs**  
**FREQUENCY**

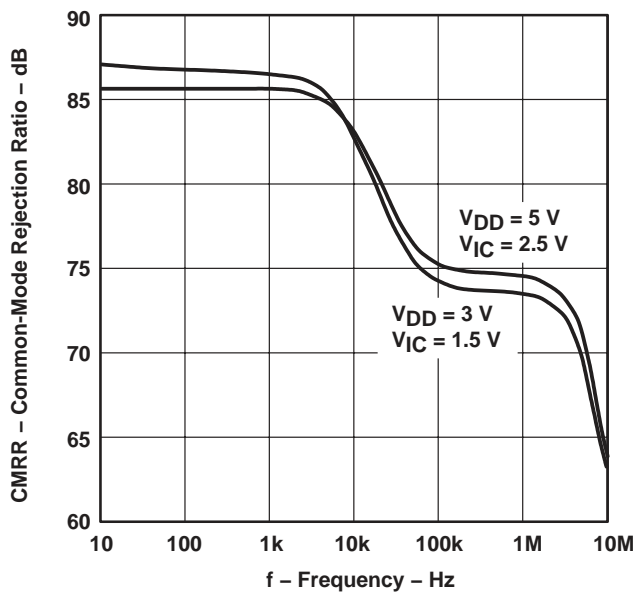

**Figure 17**



# TLV2460, TLV2461, TLV2462, TLV2463, TLV2464, TLV2465, TLV246xA FAMILY OF LOW-POWER RAIL-TO-RAIL INPUT/OUTPUT OPERATIONAL AMPLIFIERS WITH SHUTDOWN

SLOS220J – JULY 1998 – REVISED FEBRUARY 2004

## TYPICAL CHARACTERISTICS

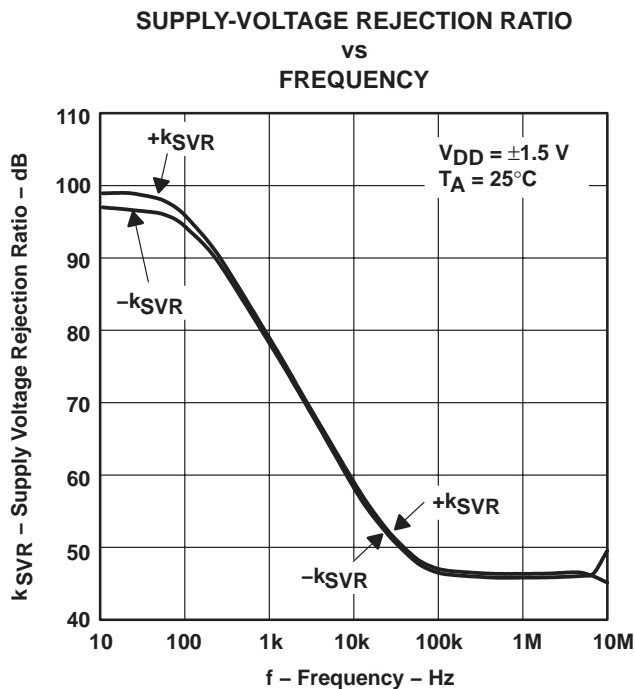

Figure 18

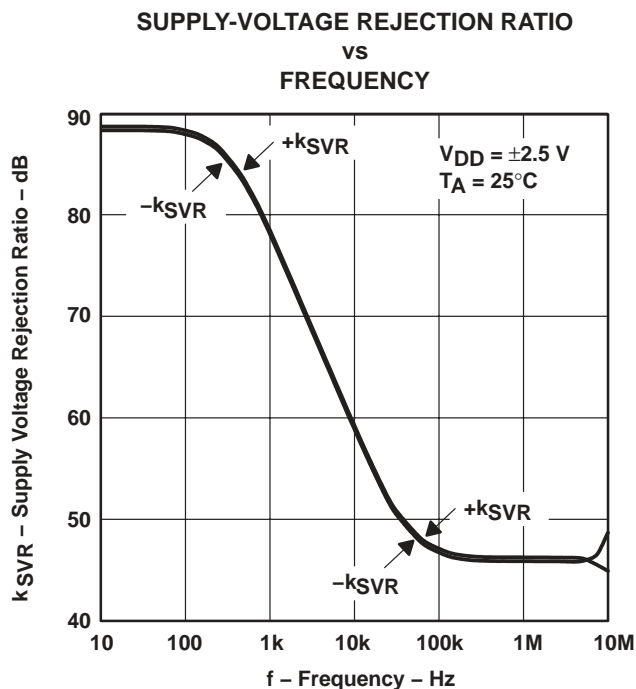

Figure 19

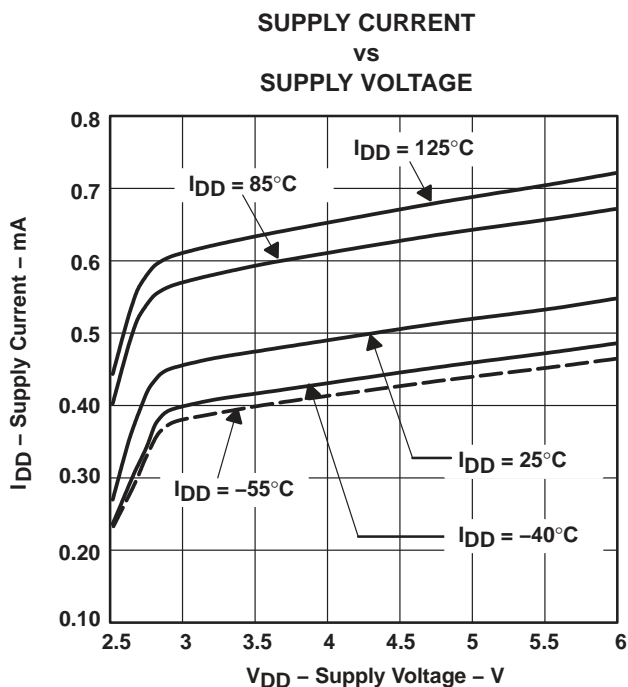

Figure 20

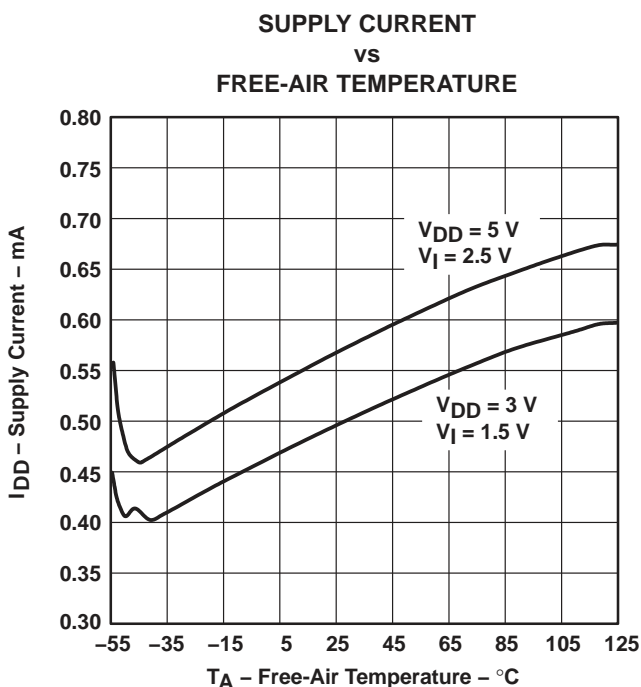

Figure 21

**TLV2460, TLV2461, TLV2462, TLV2463, TLV2464, TLV2465, TLV246xA**  
**FAMILY OF LOW-POWER RAIL-TO-RAIL INPUT/OUTPUT**  
**OPERATIONAL AMPLIFIERS WITH SHUTDOWN**

SLOS220J – JULY 1998 – REVISED FEBRUARY 2004

**TYPICAL CHARACTERISTICS**

**AMPLIFIER WITH A SHUTDOWN PULSE  
 TURNON CHARACTERISTICS**

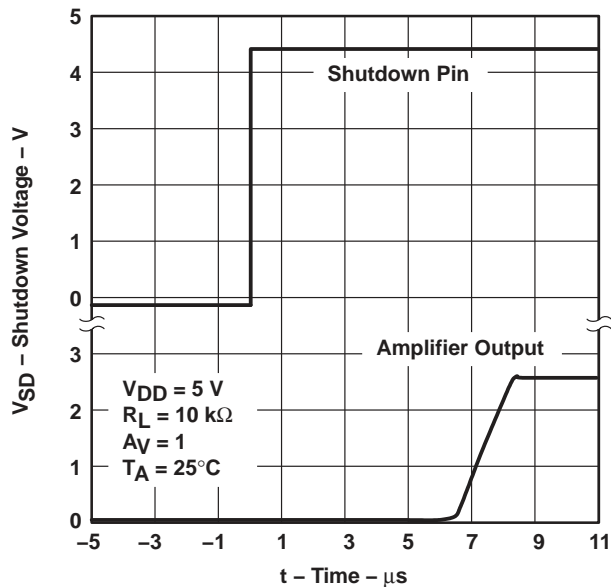

**Figure 22**

**AMPLIFIER WITH A SHUTDOWN PULSE  
 TURNOFF CHARACTERISTICS**

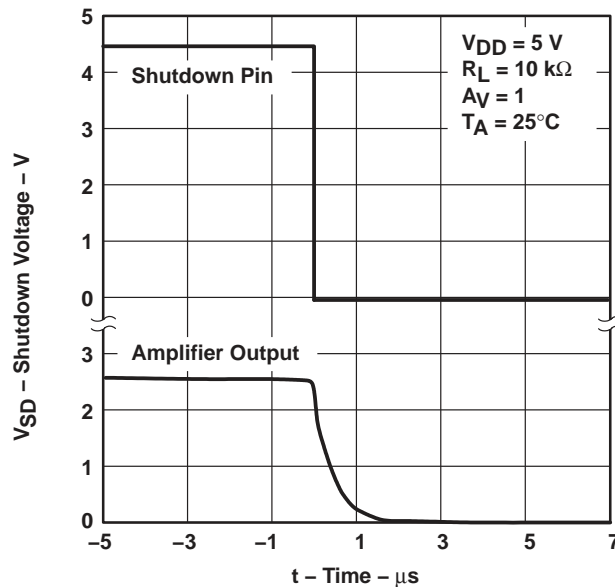

**Figure 23**

**SUPPLY CURRENT WITH A SHUTDOWN PULSE  
 TURNON CHARACTERISTICS**

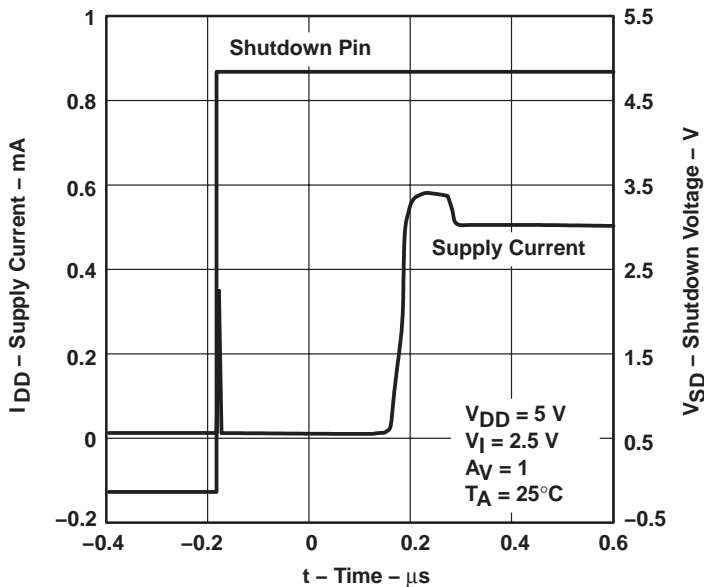

**Figure 24**

# TLV2460, TLV2461, TLV2462, TLV2463, TLV2464, TLV2465, TLV246xA FAMILY OF LOW-POWER RAIL-TO-RAIL INPUT/OUTPUT OPERATIONAL AMPLIFIERS WITH SHUTDOWN

SLOS220J – JULY 1998 – REVISED FEBRUARY 2004

## TYPICAL CHARACTERISTICS

TURN-OFF SUPPLY CURRENT  
WITH A SHUTDOWN PULSE

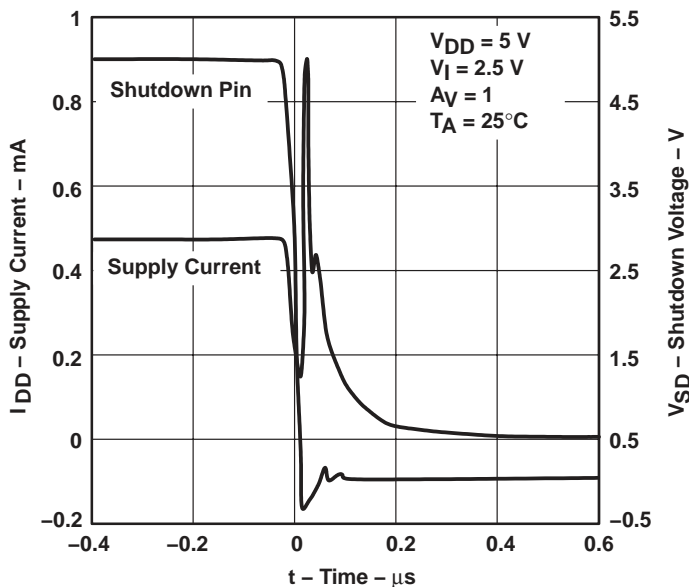

Figure 25

SHUTDOWN SUPPLY CURRENT  
vs  
FREE-AIR TEMPERATURE

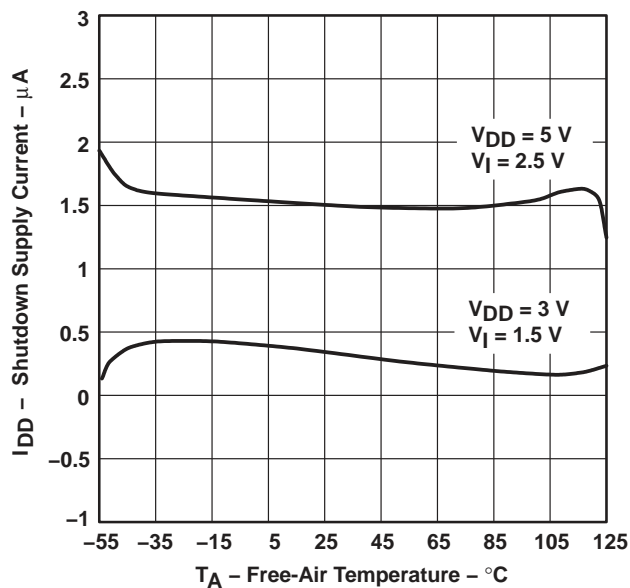

Figure 26

SLEW RATE  
vs  
SUPPLY VOLTAGE

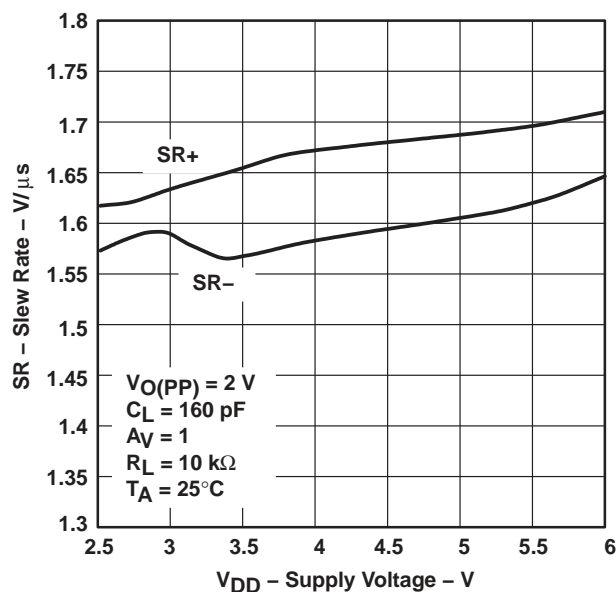

Figure 27

**TLV2460, TLV2461, TLV2462, TLV2463, TLV2464, TLV2465, TLV246xA**  
**FAMILY OF LOW-POWER RAIL-TO-RAIL INPUT/OUTPUT**  
**OPERATIONAL AMPLIFIERS WITH SHUTDOWN**

SLOS220J – JULY 1998 – REVISED FEBRUARY 2004

**TYPICAL CHARACTERISTICS**

**EQUIVALENT INPUT NOISE VOLTAGE  
 vs  
 FREQUENCY**

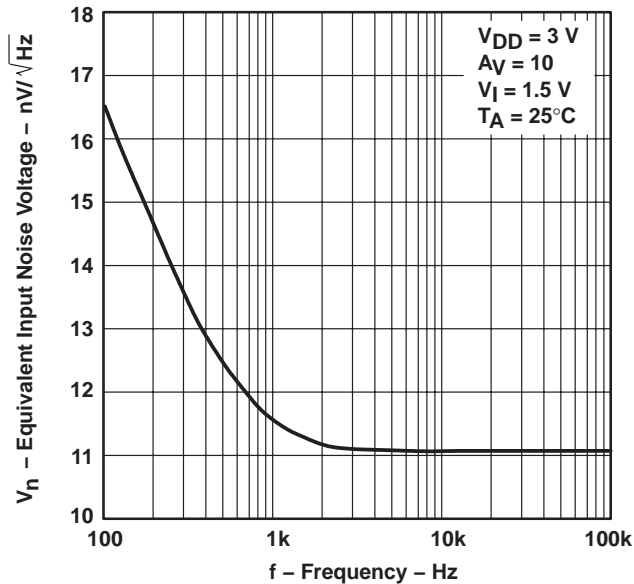

**Figure 28**

**EQUIVALENT INPUT NOISE VOLTAGE  
 vs  
 FREQUENCY**

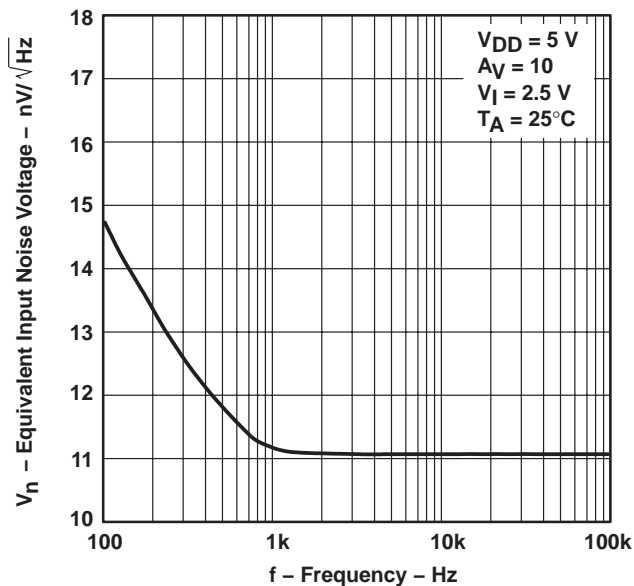

**Figure 29**

**EQUIVALENT INPUT NOISE VOLTAGE  
 vs  
 COMMON-MODE INPUT VOLTAGE**

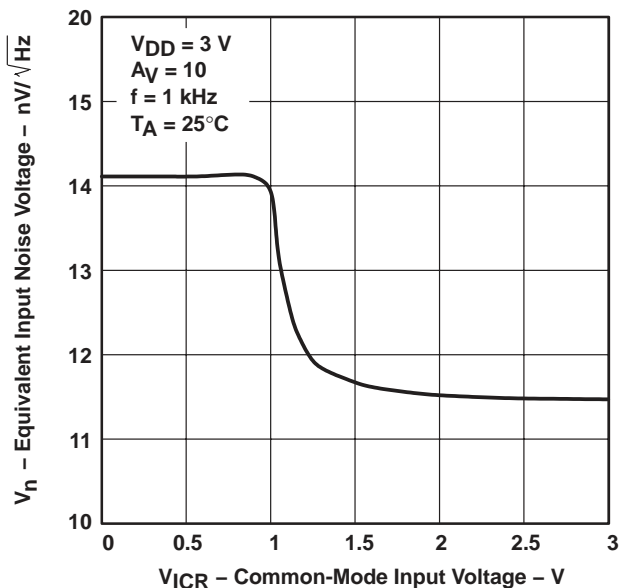

**Figure 30**

**EQUIVALENT INPUT NOISE VOLTAGE  
 vs  
 COMMON-MODE INPUT VOLTAGE**

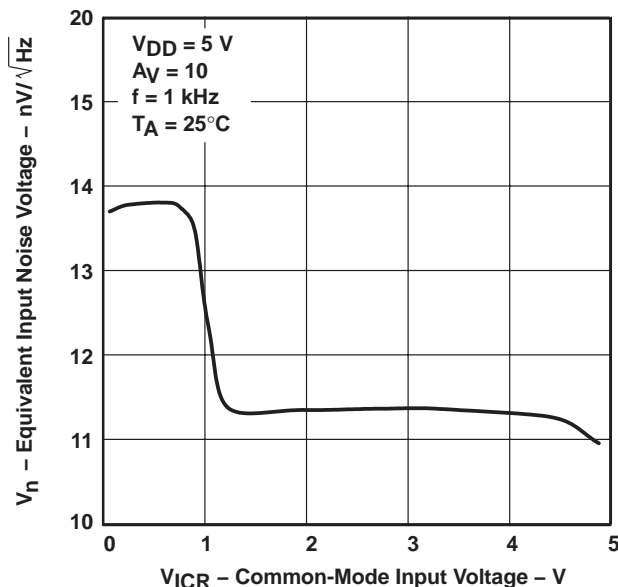

**Figure 31**

# TLV2460, TLV2461, TLV2462, TLV2463, TLV2464, TLV2465, TLV246xA FAMILY OF LOW-POWER RAIL-TO-RAIL INPUT/OUTPUT OPERATIONAL AMPLIFIERS WITH SHUTDOWN

SLOS220J – JULY 1998 – REVISED FEBRUARY 2004

## TYPICAL CHARACTERISTICS

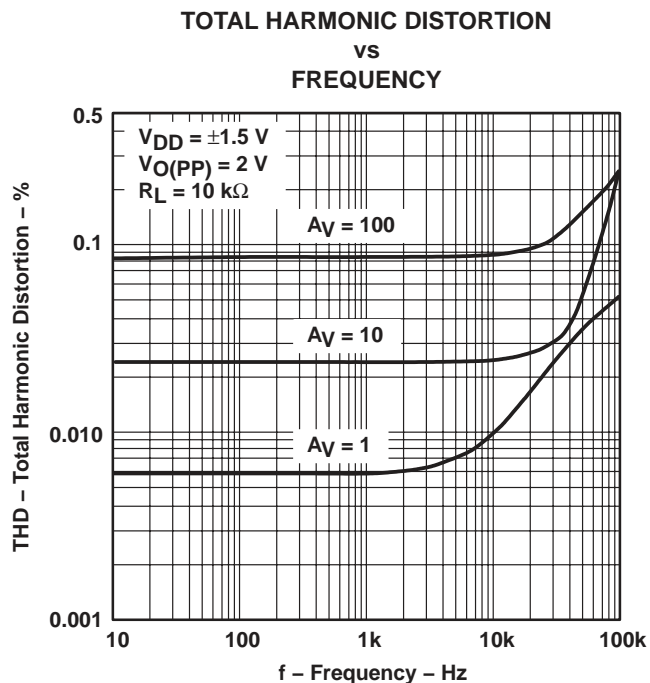

Figure 32

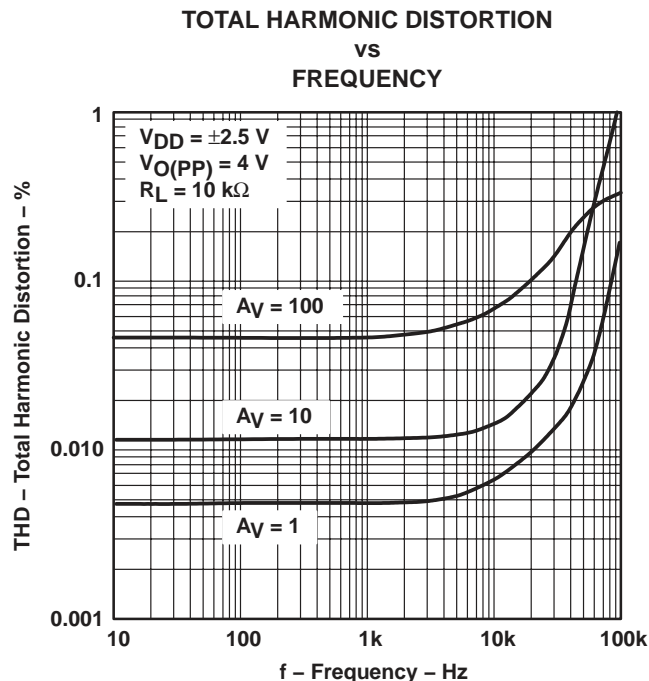

Figure 33

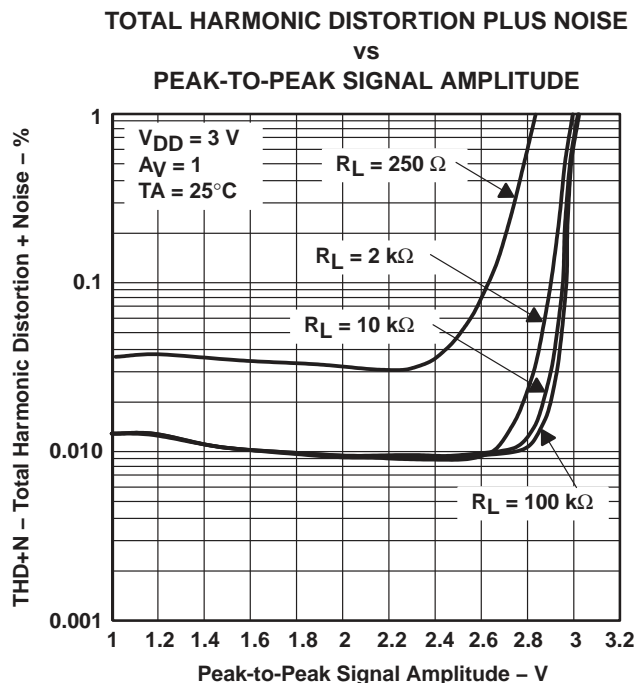

Figure 34

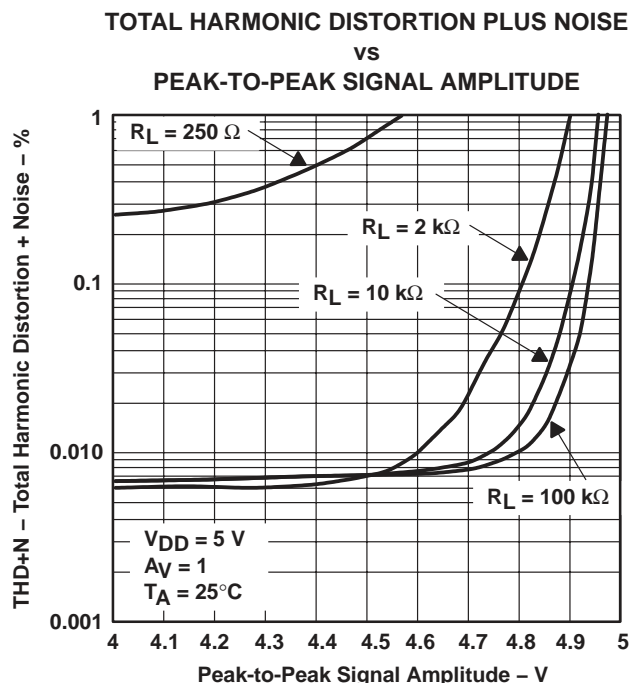

Figure 35

# TLV2460, TLV2461, TLV2462, TLV2463, TLV2464, TLV2465, TLV246xA FAMILY OF LOW-POWER RAIL-TO-RAIL INPUT/OUTPUT OPERATIONAL AMPLIFIERS WITH SHUTDOWN

SLOS220J – JULY 1998 – REVISED FEBRUARY 2004

## TYPICAL CHARACTERISTICS

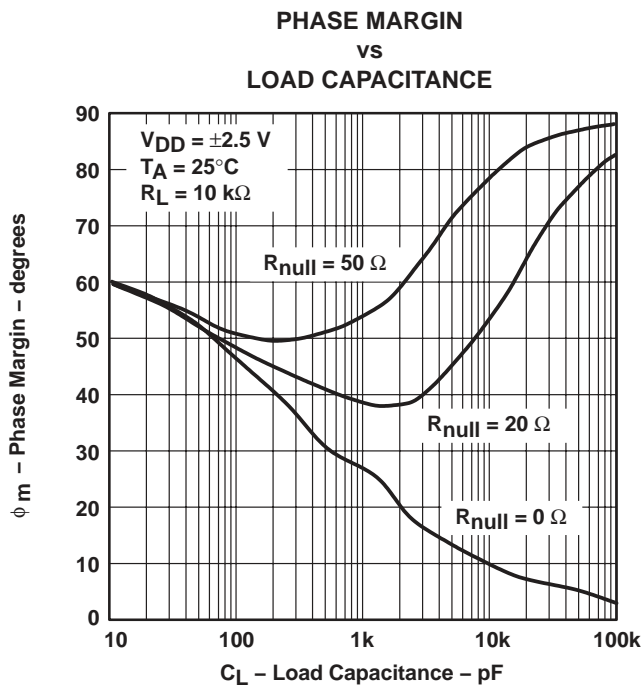

Figure 36

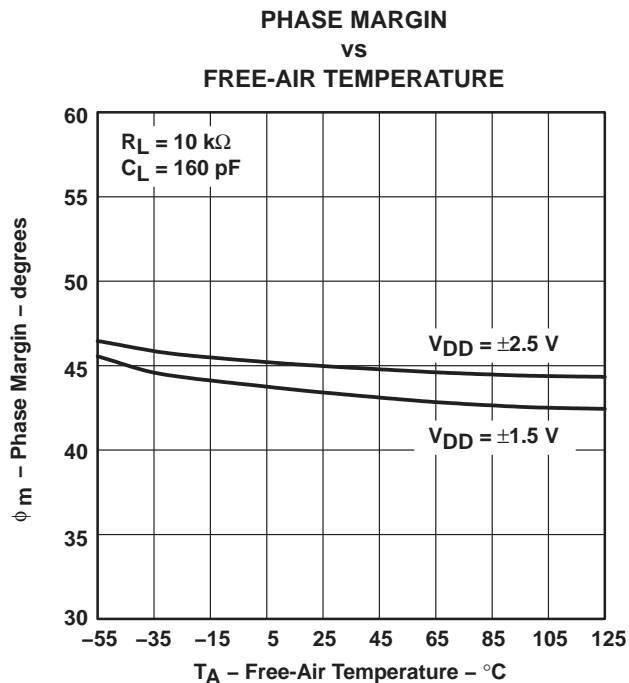

Figure 37

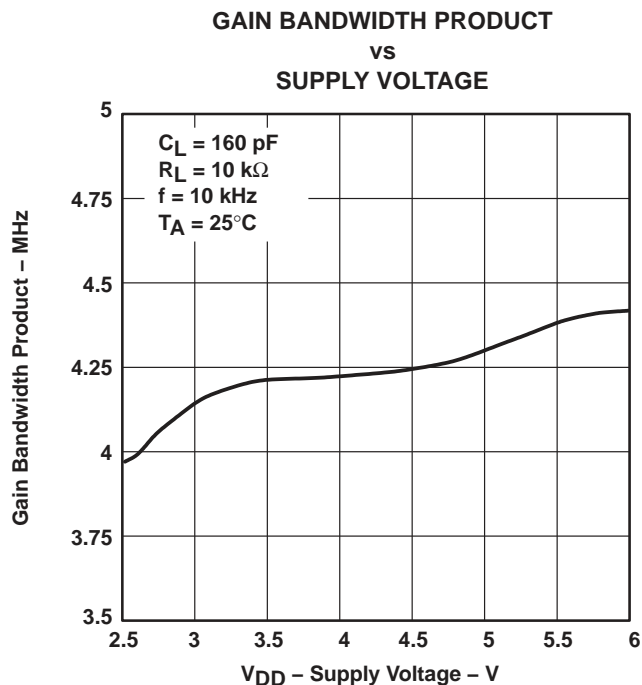

Figure 38

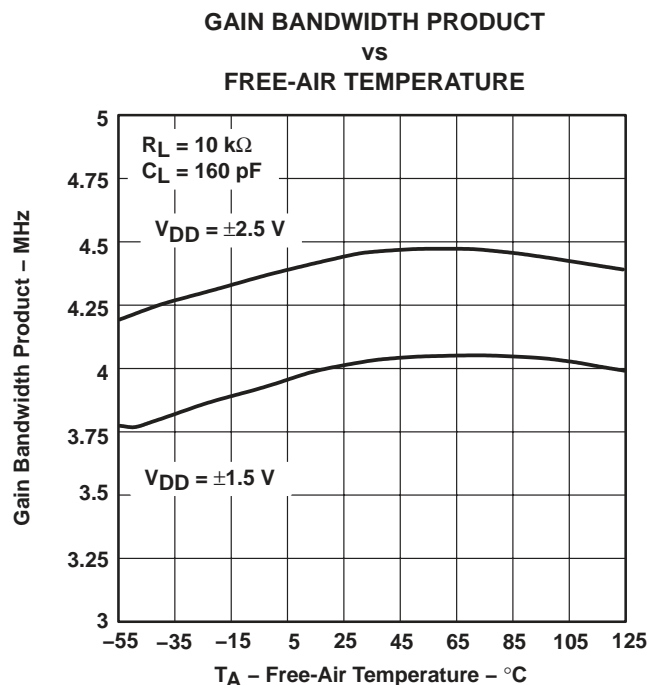

Figure 39

# TLV2460, TLV2461, TLV2462, TLV2463, TLV2464, TLV2465, TLV246xA FAMILY OF LOW-POWER RAIL-TO-RAIL INPUT/OUTPUT OPERATIONAL AMPLIFIERS WITH SHUTDOWN

SLOS220J – JULY 1998 – REVISED FEBRUARY 2004

## TYPICAL CHARACTERISTICS

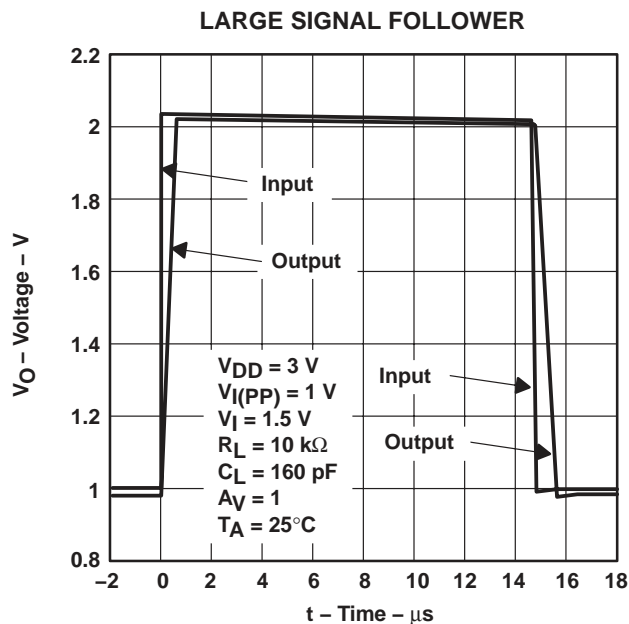

Figure 40

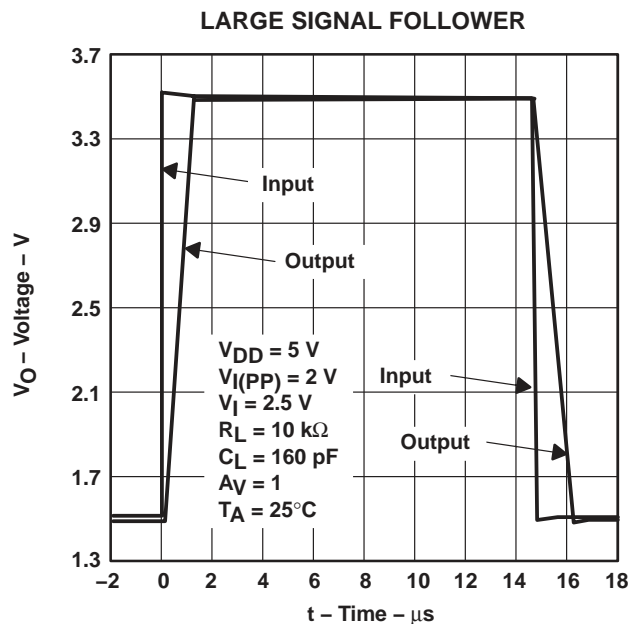

Figure 41

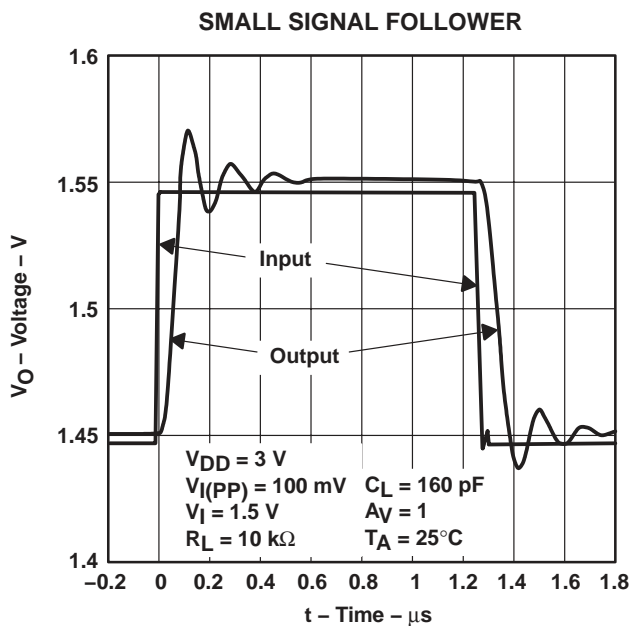

Figure 42

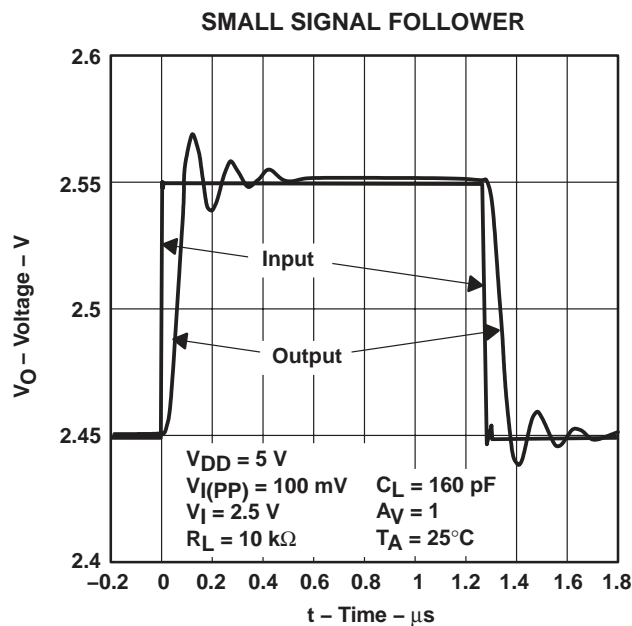
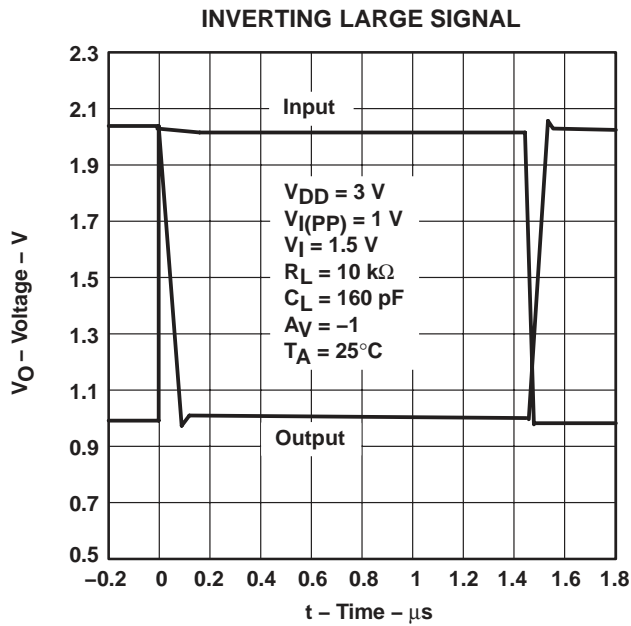

Figure 43

**TLV2460, TLV2461, TLV2462, TLV2463, TLV2464, TLV2465, TLV246xA**  
**FAMILY OF LOW-POWER RAIL-TO-RAIL INPUT/OUTPUT**  
**OPERATIONAL AMPLIFIERS WITH SHUTDOWN**

SLOS220J – JULY 1998 – REVISED FEBRUARY 2004

**TYPICAL CHARACTERISTICS**



**Figure 44**

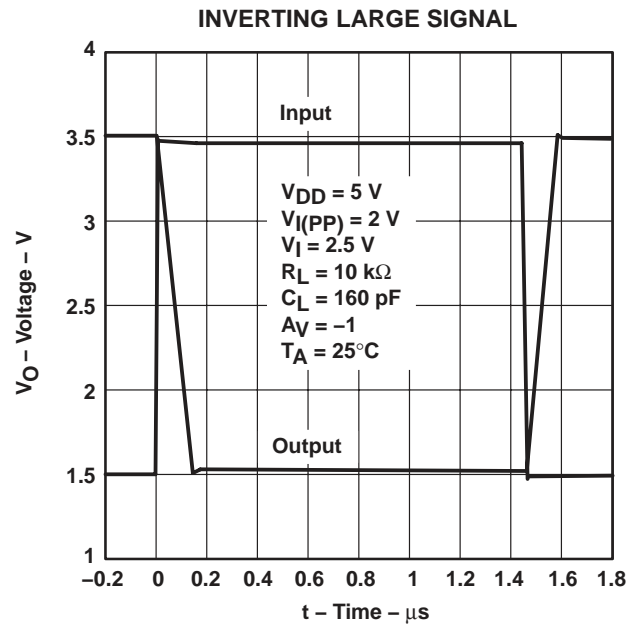

**Figure 45**

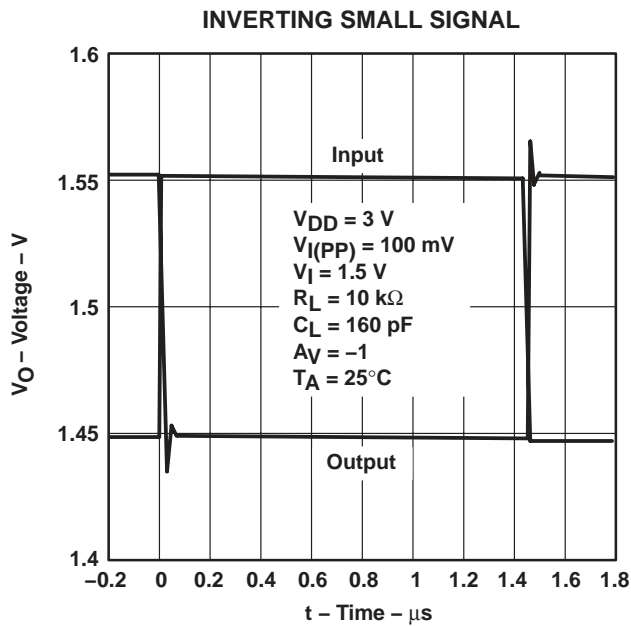

**Figure 46**

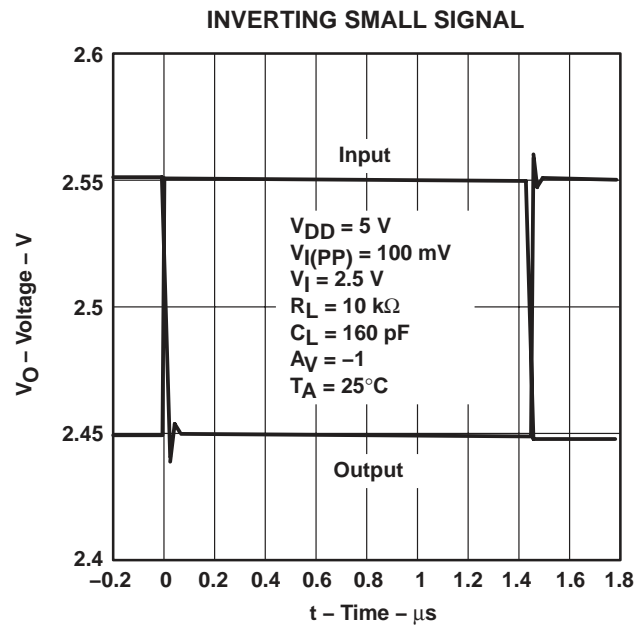

**Figure 47**



# TLV2460, TLV2461, TLV2462, TLV2463, TLV2464, TLV2465, TLV246xA FAMILY OF LOW-POWER RAIL-TO-RAIL INPUT/OUTPUT OPERATIONAL AMPLIFIERS WITH SHUTDOWN

SLOS220J – JULY 1998 – REVISED FEBRUARY 2004

## PARAMETER MEASUREMENT INFORMATION

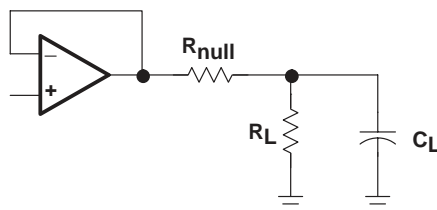

Figure 48

## APPLICATION INFORMATION

### driving a capacitive load

When the amplifier is configured in this manner, capacitive loading directly on the output will decrease the device's phase margin leading to high frequency ringing or oscillations. Therefore, for capacitive loads of greater than 10 pF, it is recommended that a resistor be placed in series ( $R_{NULL}$ ) with the output of the amplifier, as shown in Figure 49. A minimum value of 20  $\Omega$  should work well for most applications.

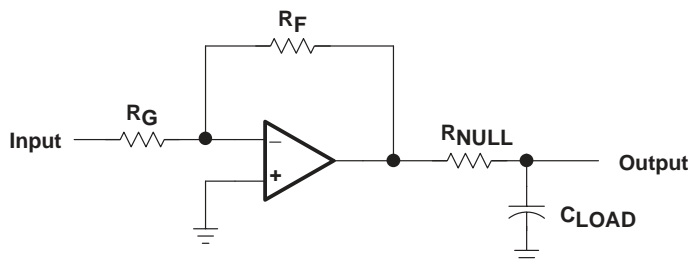

Figure 49. Driving a Capacitive Load

### offset voltage

The output offset voltage, ( $V_{OO}$ ) is the sum of the input offset voltage ( $V_{IO}$ ) and both input bias currents ( $I_{IB}$ ) times the corresponding gains. The following schematic and formula can be used to calculate the output offset voltage:

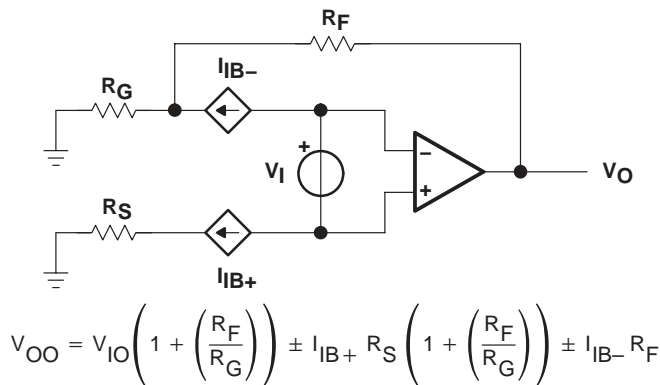

Figure 50. Output Offset Voltage Model

# TLV2460, TLV2461, TLV2462, TLV2463, TLV2464, TLV2465, TLV246xA FAMILY OF LOW-POWER RAIL-TO-RAIL INPUT/OUTPUT OPERATIONAL AMPLIFIERS WITH SHUTDOWN

SLOS220J – JULY 1998 – REVISED FEBRUARY 2004

## APPLICATION INFORMATION

### general configurations

When receiving low-level signals, limiting the bandwidth of the incoming signals into the system is often required. The simplest way to accomplish this is to place an RC filter at the noninverting terminal of the amplifier (see Figure 51).

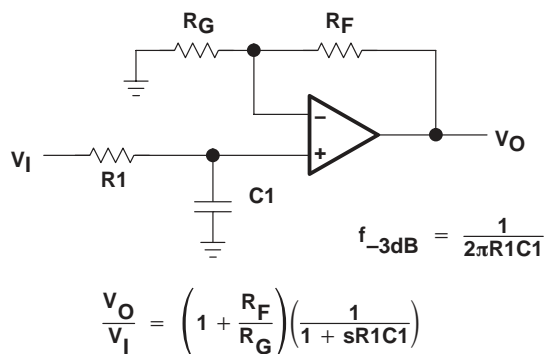

Figure 51. Single-Pole Low-Pass Filter

If even more attenuation is needed, a multiple pole filter is required. The Sallen-Key filter can be used for this task. For best results, the amplifier should have a bandwidth that is 8 to 10 times the filter frequency bandwidth. Failure to do this can result in phase shift of the amplifier.

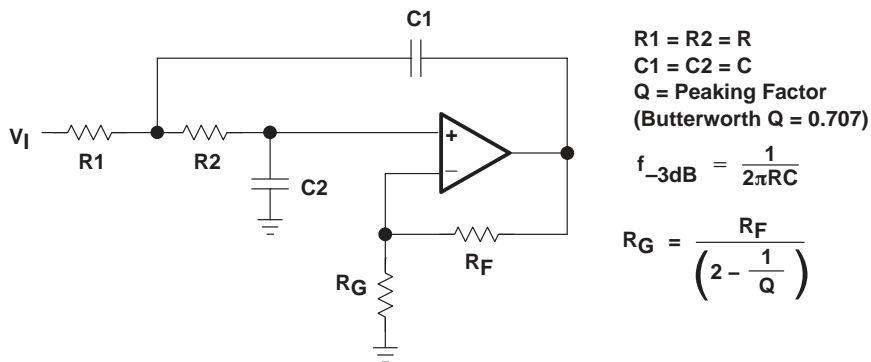

Figure 52. 2-Pole Low-Pass Sallen-Key Filter

# TLV2460, TLV2461, TLV2462, TLV2463, TLV2464, TLV2465, TLV246xA FAMILY OF LOW-POWER RAIL-TO-RAIL INPUT/OUTPUT OPERATIONAL AMPLIFIERS WITH SHUTDOWN

SLOS220J – JULY 1998 – REVISED FEBRUARY 2004

## APPLICATION INFORMATION

### shutdown function

Three members of the TLV246x family (TLV2460/3/5) have a shutdown terminal for conserving battery life in portable applications. When the shutdown terminal is tied low, the supply current is reduced to 0.3  $\mu\text{A}/\text{channel}$ , the amplifier is disabled, and the outputs are placed in a high impedance mode. To enable the amplifier, the shutdown terminal can either be left floating or pulled high. When the shutdown terminal is left floating, care should be taken to ensure that parasitic leakage current at the shutdown terminal does not inadvertently place the operational amplifier into shutdown. The shutdown terminal threshold is always referenced to  $V_{\text{DD}}/2$ . Therefore, when operating the device with split supply voltages (e.g.  $\pm 2.5\text{ V}$ ), the shutdown terminal needs to be pulled to  $V_{\text{DD-}}$  (not GND) to disable the operational amplifier.

The amplifier's output with a shutdown pulse is shown in Figures 22, 23, 24, and 25. The amplifier is powered with a single 5-V supply and configured as a noninverting configuration with a gain of 5. The amplifier turnon and turnoff times are measured from the 50% point of the shutdown pulse to the 50% point of the output waveform. The times for the single, dual, and quad are listed in the data tables.

### circuit layout considerations

To achieve the levels of high performance of the TLV246x, follow proper printed-circuit board design techniques. A general set of guidelines is given in the following.

- Ground planes – It is highly recommended that a ground plane be used on the board to provide all components with a low inductive ground connection. However, in the areas of the amplifier inputs and output, the ground plane can be removed to minimize the stray capacitance.
- Proper power supply decoupling – Use a 6.8- $\mu\text{F}$  tantalum capacitor in parallel with a 0.1- $\mu\text{F}$  ceramic capacitor on each supply terminal. It may be possible to share the tantalum among several amplifiers depending on the application, but a 0.1- $\mu\text{F}$  ceramic capacitor should always be used on the supply terminal of every amplifier. In addition, the 0.1- $\mu\text{F}$  capacitor should be placed as close as possible to the supply terminal. As this distance increases, the inductance in the connecting trace makes the capacitor less effective. The designer should strive for distances of less than 0.1 inches between the device power terminals and the ceramic capacitors.
- Sockets – Sockets can be used but are not recommended. The additional lead inductance in the socket pins will often lead to stability problems. Surface-mount packages soldered directly to the printed-circuit board is the best implementation.
- Short trace runs/compact part placements – Optimum high performance is achieved when stray series inductance has been minimized. To realize this, the circuit layout should be made as compact as possible, thereby minimizing the length of all trace runs. Particular attention should be paid to the inverting input of the amplifier. Its length should be kept as short as possible. This will help to minimize stray capacitance at the input of the amplifier.
- Surface-mount passive components – Using surface-mount passive components is recommended for high performance amplifier circuits for several reasons. First, because of the extremely low lead inductance of surface-mount components, the problem with stray series inductance is greatly reduced. Second, the small size of surface-mount components naturally leads to a more compact layout thereby minimizing both stray inductance and capacitance. If leaded components are used, it is recommended that the lead lengths be kept as short as possible.

# TLV2460, TLV2461, TLV2462, TLV2463, TLV2464, TLV2465, TLV246xA FAMILY OF LOW-POWER RAIL-TO-RAIL INPUT/OUTPUT OPERATIONAL AMPLIFIERS WITH SHUTDOWN

SLOS220J – JULY 1998 – REVISED FEBRUARY 2004

## APPLICATION INFORMATION

### general power dissipation considerations

For a given  $\theta_{JA}$ , the maximum power dissipation is shown in Figure 53 and is calculated by the following formula:

$$P_D = \left( \frac{T_{MAX} - T_A}{\theta_{JA}} \right)$$

Where:

$P_D$  = Maximum power dissipation of THS246x IC (watts)

$T_{MAX}$  = Absolute maximum junction temperature (150°C)

$T_A$  = Free-ambient air temperature (°C)

$\theta_{JA}$  =  $\theta_{JC} + \theta_{CA}$

$\theta_{JC}$  = Thermal coefficient from junction to case

$\theta_{CA}$  = Thermal coefficient from case to ambient air (°C/W)

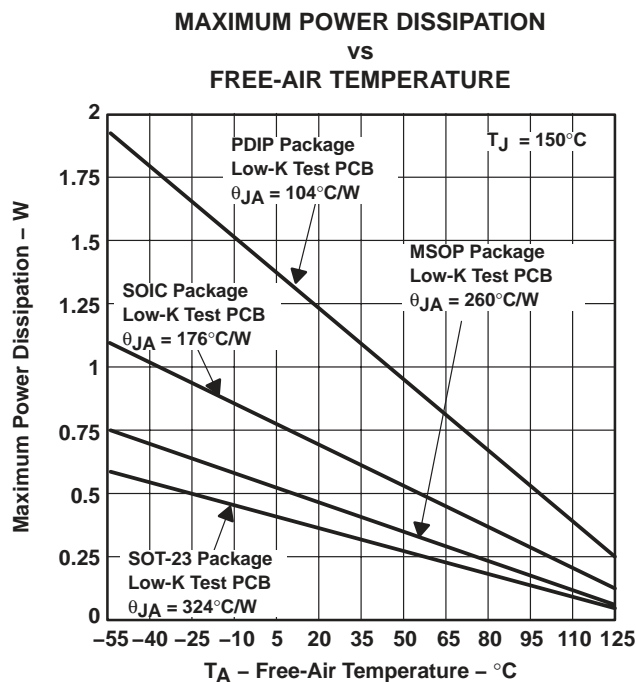

NOTE A: Results are with no air flow and using JEDEC Standard Low-K test PCB.

**Figure 53. Maximum Power Dissipation vs Free-Air Temperature**

# TLV2460, TLV2461, TLV2462, TLV2463, TLV2464, TLV2465, TLV246xA FAMILY OF LOW-POWER RAIL-TO-RAIL INPUT/OUTPUT OPERATIONAL AMPLIFIERS WITH SHUTDOWN

SLOS220J – JULY 1998 – REVISED FEBRUARY 2004

## APPLICATION INFORMATION

### macromodel information

Macromodel information provided was derived using Microsim *Parts*™ Release 8, the model generation software used with Microsim *PSpice*™. The Boyle macromodel (see Note 2) and subcircuit in Figure 54 are generated using the TLV246x typical electrical and operating characteristics at  $T_A = 25^\circ\text{C}$ . Using this information, output simulations of the following key parameters can be generated to a tolerance of 20% (in most cases):

- Maximum positive output voltage swing
- Maximum negative output voltage swing
- Slew rate
- Quiescent power dissipation
- Input bias current
- Open-loop voltage amplification
- Unity-gain frequency
- Common-mode rejection ratio
- Phase margin
- DC output resistance
- AC output resistance
- Short-circuit output current limit

NOTE 2: G. R. Boyle, B. M. Cohn, D. O. Pederson, and J. E. Solomon, "Macromodeling of Integrated Circuit Operational Amplifiers", *IEEE Journal of Solid-State Circuits*, SC-9, 353 (1974).

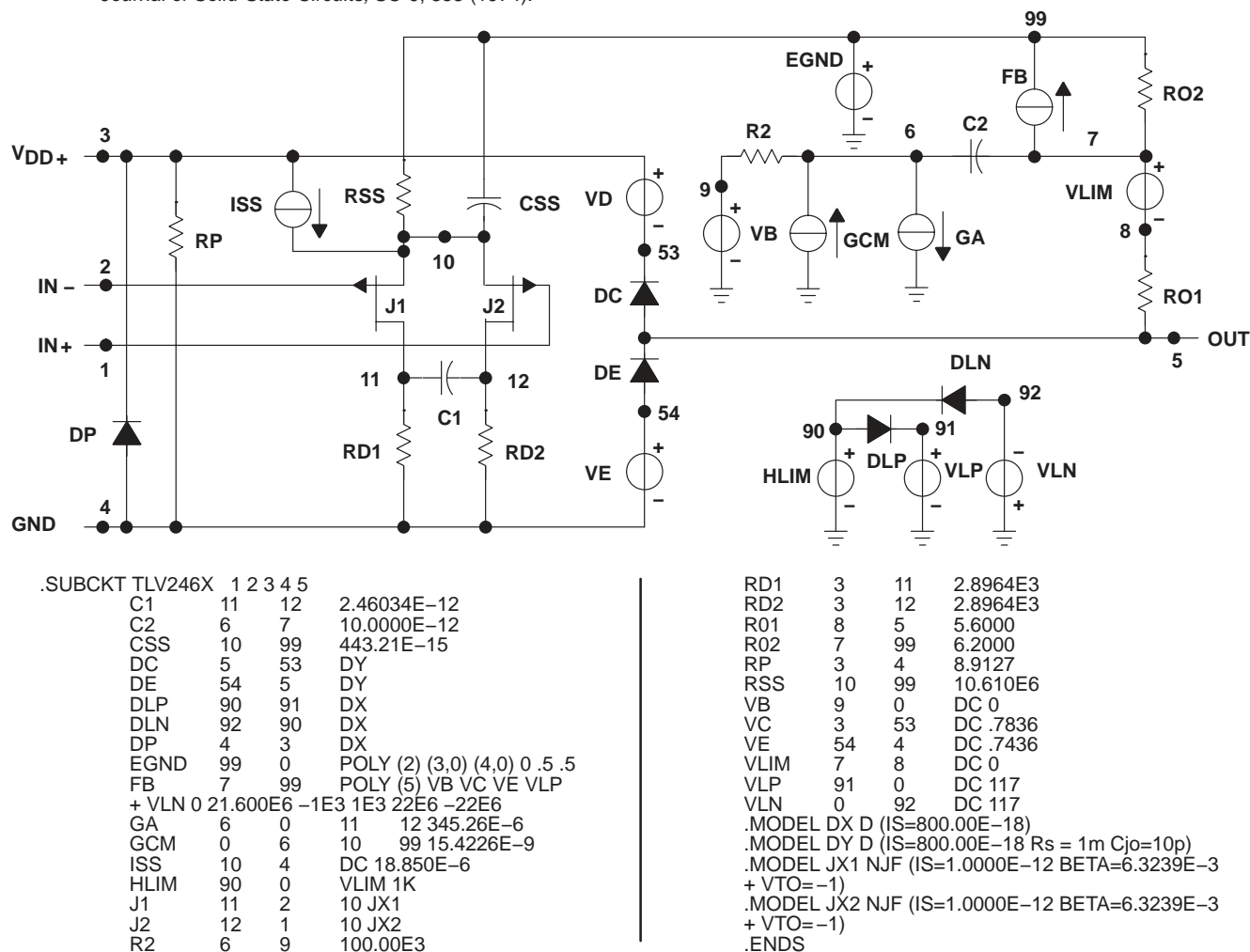

Figure 54. Boyle Macromodels and Subcircuit

*PSpice* and *Parts* are trademarks of MicroSim Corporation.

# TLV2460, TLV2461, TLV2462, TLV2463, TLV2464, TLV2465, TLV246xA

## FAMILY OF LOW-POWER RAIL-TO-RAIL INPUT/OUTPUT OPERATIONAL AMPLIFIERS WITH SHUTDOWN

SLOS220J – JULY 1998 – REVISED FEBRUARY 2004

### macromodel information (continued)

```

.subckt TLV_246Y 1 2 3 4 5 6
  c1      11      12      2.4603E-12
  c2      72      7       10.000E-12
  css     10      99      443.21E-15
  dc      70      53      dy
  de      54      70      dy
  dlp     90      91      dx
  dln     92      90      dx
  dp      4        3      dx
  egnd    99      0      poly(2) (3,0) (4,0) 0 .5 .5
  fb      7        99     poly(5) vb vc ve vlp vln 0
21.600E6 -1E3 1E3 22E6 -22E6
  ga      72      0      11 12 345.26E-6
  gcm     0       72     10 99 15.422E-9
  iss     74      4      dc 18.850E-6
  hlim    90      0      vlim 1K
  j1      11      2      10 jx1
  j2      12      1      10 jx2
  r2      72      9      100.00E3
  rd1     3       11     2.8964E3
  rd2     3       12     2.8964E3
  ro1     8       70     5.6000
  ro2     7       99     6.2000
  rp      3       71     8.9127
  rss     10      99     10.610E6
  rs1     6       4      1G
  rs2     6       4      1G
  rs3     6       4      1G
  rs4     6       4      1G
  s1      71      4      6 4 s1x
  s2      70      5      6 4 s1x
  s3      10      74     6 4 s1x
  s4      74      4      6 4 s2x
  vb      9       0      dc 0
  vc      3       53     dc .7836
  ve      54      4      dc .7436
  vlim    7       8      dc 0
  vlp     91      0      dc 117
  vln     0       92     dc 117
.model dx D(Is=800.00E-18)
.model dy D(Is=800.00E-18 Rs=1m Cjo=10p)
.model jx1 NJF(Is=1.0000E-12 Beta=6.3239E-3 Vto=-1)
.model jx2 NJF(Is=1.0000E-12 Beta=6.3239E-3 Vto=-1)
.model s1x VSWITCH(Roff=1E8 Ron=1.0 Voff=2.5 Von=0.0)
.model s2x VSWITCH(Roff=1E8 Ron=1.0 Voff=0 Von=2.5)
.ends

```

Figure 54. Boyle Macromodels and Subcircuit (Continued)

**PACKAGING INFORMATION**

| Orderable Device | Status<br>(1) | Package Type | Package Drawing | Pins | Package Qty | Eco Plan<br>(2)  | Lead finish/<br>Ball material<br>(6) | MSL Peak Temp<br>(3) | Op Temp (°C) | Device Marking<br>(4/5)                 | Samples                 |
|------------------|---------------|--------------|-----------------|------|-------------|------------------|--------------------------------------|----------------------|--------------|---|-------------------------|
| 5962-0051201QHA  | ACTIVE        | CFP          | U               | 10   | 1           | Non-RoHS & Green | SNPB                                 | N / A for Pkg Type   | -55 to 125   | 0051201QHA<br>TLV2460M                  | <a href="#">Samples</a> |
| 5962-0051203QHA  | ACTIVE        | CFP          | U               | 10   | 1           | Non-RoHS & Green | SNPB                                 | N / A for Pkg Type   | -55 to 125   | 0051203QHA<br>TLV2461M                  | <a href="#">Samples</a> |
| 5962-0051205QHA  | ACTIVE        | CFP          | U               | 10   | 1           | Non-RoHS & Green | SNPB                                 | N / A for Pkg Type   | -55 to 125   | 0051205QHA<br>TLV2462M                  | <a href="#">Samples</a> |
| 5962-0051206Q2A  | ACTIVE        | LCCC         | FK              | 20   | 1           | Non-RoHS & Green | SNPB                                 | N / A for Pkg Type   | -55 to 125   | 5962-<br>0051206Q2A<br>TLV2462A<br>MFKB | <a href="#">Samples</a> |
| 5962-0051206QHA  | ACTIVE        | CFP          | U               | 10   | 1           | Non-RoHS & Green | SNPB                                 | N / A for Pkg Type   | -55 to 125   | 0051206QHA<br>TLV2462AM                 | <a href="#">Samples</a> |
| 5962-0051206QPA  | ACTIVE        | CDIP         | JG              | 8    | 1           | Non-RoHS & Green | SNPB                                 | N / A for Pkg Type   | -55 to 125   | 0051206QPA<br>TLV2462AM                 | <a href="#">Samples</a> |
| TLV2460AIDR      | ACTIVE        | SOIC         | D               | 8    | 2500        | RoHS & Green     | NIPDAU                               | Level-1-260C-UNLIM   | -40 to 125   | 2460AI                                  | <a href="#">Samples</a> |
| TLV2460AIP       | ACTIVE        | PDIP         | P               | 8    | 50          | RoHS & Green     | NIPDAU                               | N / A for Pkg Type   | -40 to 125   | TLV2460AI                               | <a href="#">Samples</a> |
| TLV2460CD        | ACTIVE        | SOIC         | D               | 8    | 75          | RoHS & Green     | NIPDAU                               | Level-1-260C-UNLIM   | 0 to 70      | 2460C                                   | <a href="#">Samples</a> |
| TLV2460CDBVR     | ACTIVE        | SOT-23       | DBV             | 6    | 3000        | RoHS & Green     | NIPDAU                               | Level-1-260C-UNLIM   | 0 to 70      | VAOC                                    | <a href="#">Samples</a> |
| TLV2460CDBVT     | ACTIVE        | SOT-23       | DBV             | 6    | 250         | RoHS & Green     | NIPDAU                               | Level-1-260C-UNLIM   | 0 to 70      | VAOC                                    | <a href="#">Samples</a> |
| TLV2460CDBVTG4   | LIFEBUY       | SOT-23       | DBV             | 6    | 250         | RoHS & Green     | NIPDAU                               | Level-1-260C-UNLIM   | 0 to 70      | VAOC                                    |                         |
| TLV2460CDR       | ACTIVE        | SOIC         | D               | 8    | 2500        | RoHS & Green     | NIPDAU                               | Level-1-260C-UNLIM   | 0 to 70      | 2460C                                   | <a href="#">Samples</a> |
| TLV2460CP        | ACTIVE        | PDIP         | P               | 8    | 50          | RoHS & Green     | NIPDAU                               | N / A for Pkg Type   | 0 to 70      | TLV2460C                                | <a href="#">Samples</a> |
| TLV2460ID        | ACTIVE        | SOIC         | D               | 8    | 75          | RoHS & Green     | NIPDAU                               | Level-1-260C-UNLIM   | -40 to 125   | 2460I                                   | <a href="#">Samples</a> |
| TLV2460IDBVR     | ACTIVE        | SOT-23       | DBV             | 6    | 3000        | RoHS & Green     | NIPDAU                               | Level-1-260C-UNLIM   | -40 to 125   | VAOI                                    | <a href="#">Samples</a> |
| TLV2460IDBVT     | ACTIVE        | SOT-23       | DBV             | 6    | 250         | RoHS & Green     | NIPDAU                               | Level-1-260C-UNLIM   | -40 to 125   | VAOI                                    | <a href="#">Samples</a> |
| TLV2460IDR       | ACTIVE        | SOIC         | D               | 8    | 2500        | RoHS & Green     | NIPDAU                               | Level-1-260C-UNLIM   | -40 to 125   | 2460I                                   | <a href="#">Samples</a> |

| Orderable Device | Status<br>(1) | Package Type | Package Drawing | Pins | Package Qty | Eco Plan<br>(2)  | Lead finish/<br>Ball material<br>(6) | MSL Peak Temp<br>(3) | Op Temp (°C) | Device Marking<br>(4/5)         | Samples                 |
|------------------|---------------|--------------|-----------------|------|-------------|------------------|--------------------------------------|----------------------|--------------|---------------------------------|-------------------------|
| TLV2460IP        | ACTIVE        | PDIP         | P               | 8    | 50          | RoHS & Green     | NIPDAU                               | N / A for Pkg Type   | -40 to 125   | TLV2460I                        | <a href="#">Samples</a> |
| TLV2460MUB       | ACTIVE        | CFP          | U               | 10   | 1           | Non-RoHS & Green | SNPB                                 | N / A for Pkg Type   | -55 to 125   | 0051201QHA<br>TLV2460M          | <a href="#">Samples</a> |
| TLV2461AID       | ACTIVE        | SOIC         | D               | 8    | 75          | RoHS & Green     | NIPDAU                               | Level-1-260C-UNLIM   | -40 to 125   | 2461AI                          | <a href="#">Samples</a> |
| TLV2461AIDR      | ACTIVE        | SOIC         | D               | 8    | 2500        | RoHS & Green     | NIPDAU                               | Level-1-260C-UNLIM   | -40 to 125   | 2461AI                          | <a href="#">Samples</a> |
| TLV2461AIP       | ACTIVE        | PDIP         | P               | 8    | 50          | RoHS & Green     | NIPDAU                               | N / A for Pkg Type   | -40 to 125   | TLV2461AI                       | <a href="#">Samples</a> |
| TLV2461CD        | ACTIVE        | SOIC         | D               | 8    | 75          | RoHS & Green     | NIPDAU                               | Level-1-260C-UNLIM   | 0 to 70      | 2461C                           | <a href="#">Samples</a> |
| TLV2461CDBVR     | ACTIVE        | SOT-23       | DBV             | 5    | 3000        | RoHS & Green     | NIPDAU                               | Level-1-260C-UNLIM   | 0 to 70      | VAPC                            | <a href="#">Samples</a> |
| TLV2461CDBVT     | ACTIVE        | SOT-23       | DBV             | 5    | 250         | RoHS & Green     | NIPDAU                               | Level-1-260C-UNLIM   | 0 to 70      | VAPC                            | <a href="#">Samples</a> |
| TLV2461CDR       | ACTIVE        | SOIC         | D               | 8    | 2500        | RoHS & Green     | NIPDAU                               | Level-1-260C-UNLIM   | 0 to 70      | 2461C                           | <a href="#">Samples</a> |
| TLV2461CP        | ACTIVE        | PDIP         | P               | 8    | 50          | RoHS & Green     | NIPDAU                               | N / A for Pkg Type   | 0 to 70      | TLV2461C                        | <a href="#">Samples</a> |
| TLV2461ID        | ACTIVE        | SOIC         | D               | 8    | 75          | RoHS & Green     | NIPDAU                               | Level-1-260C-UNLIM   | -40 to 125   | 2461I                           | <a href="#">Samples</a> |
| TLV2461IDBVR     | ACTIVE        | SOT-23       | DBV             | 5    | 3000        | RoHS & Green     | NIPDAU                               | Level-1-260C-UNLIM   | -40 to 125   | VAPI                            | <a href="#">Samples</a> |
| TLV2461IDBVT     | ACTIVE        | SOT-23       | DBV             | 5    | 250         | RoHS & Green     | NIPDAU                               | Level-1-260C-UNLIM   | -40 to 125   | VAPI                            | <a href="#">Samples</a> |
| TLV2461IDR       | ACTIVE        | SOIC         | D               | 8    | 2500        | RoHS & Green     | NIPDAU                               | Level-1-260C-UNLIM   | -40 to 125   | 2461I                           | <a href="#">Samples</a> |
| TLV2461IP        | ACTIVE        | PDIP         | P               | 8    | 50          | RoHS & Green     | NIPDAU                               | N / A for Pkg Type   | -40 to 125   | TLV2461I                        | <a href="#">Samples</a> |
| TLV2461MUB       | ACTIVE        | CFP          | U               | 10   | 1           | Non-RoHS & Green | SNPB                                 | N / A for Pkg Type   | -55 to 125   | 0051203QHA<br>TLV2461M          | <a href="#">Samples</a> |
| TLV2462AID       | ACTIVE        | SOIC         | D               | 8    | 75          | RoHS & Green     | NIPDAU                               | Level-1-260C-UNLIM   | -40 to 125   | 2462AI                          | <a href="#">Samples</a> |
| TLV2462AIDR      | ACTIVE        | SOIC         | D               | 8    | 2500        | RoHS & Green     | NIPDAU                               | Level-1-260C-UNLIM   | -40 to 125   | 2462AI                          | <a href="#">Samples</a> |
| TLV2462AIP       | ACTIVE        | PDIP         | P               | 8    | 50          | RoHS & Green     | NIPDAU                               | N / A for Pkg Type   | -40 to 125   | TLV2462AI                       | <a href="#">Samples</a> |
| TLV2462AMFKB     | ACTIVE        | LCCC         | FK              | 20   | 1           | Non-RoHS & Green | SNPB                                 | N / A for Pkg Type   | -55 to 125   | 5962-<br>0051206Q2A<br>TLV2462A | <a href="#">Samples</a> |



| Orderable Device | Status<br>(1) | Package Type | Package Drawing | Pins | Package Qty | Eco Plan<br>(2)  | Lead finish/<br>Ball material<br>(6) | MSL Peak Temp<br>(3) | Op Temp (°C) | Device Marking<br>(4/5) | Samples                 |
|------------------|---------------|--------------|-----------------|------|-------------|------------------|--------------------------------------|----------------------|--------------|-------------------------|-------------------------|
|                  |               |              |                 |      |             |                  |                                      |                      |              | MFKB                    |                         |
| TLV2462AMJG      | ACTIVE        | CDIP         | JG              | 8    | 1           | Non-RoHS & Green | SNPB                                 | N / A for Pkg Type   | -55 to 125   | TLV2462AMJG             | <a href="#">Samples</a> |
| TLV2462AMJGB     | ACTIVE        | CDIP         | JG              | 8    | 1           | Non-RoHS & Green | SNPB                                 | N / A for Pkg Type   | -55 to 125   | 0051206QPA<br>TLV2462AM | <a href="#">Samples</a> |
| TLV2462AMUB      | ACTIVE        | CFP          | U               | 10   | 1           | Non-RoHS & Green | SNPB                                 | N / A for Pkg Type   | -55 to 125   | 0051206QHA<br>TLV2462AM | <a href="#">Samples</a> |
| TLV2462AQD       | ACTIVE        | SOIC         | D               | 8    | 75          | RoHS & Green     | NIPDAU                               | Level-1-260C-UNLIM   | -40 to 125   | V2462A                  | <a href="#">Samples</a> |
| TLV2462AQDG4     | ACTIVE        | SOIC         | D               | 8    | 75          | RoHS & Green     | NIPDAU                               | Level-1-260C-UNLIM   |              | V2462A                  | <a href="#">Samples</a> |
| TLV2462AQDRG4    | ACTIVE        | SOIC         | D               | 8    | 2500        | RoHS & Green     | NIPDAU                               | Level-1-260C-UNLIM   |              | V2462A                  | <a href="#">Samples</a> |
| TLV2462AQPWR     | ACTIVE        | TSSOP        | PW              | 8    | 2000        | RoHS & Green     | NIPDAU                               | Level-1-260C-UNLIM   | -40 to 125   | V2462A                  | <a href="#">Samples</a> |
| TLV2462CD        | ACTIVE        | SOIC         | D               | 8    | 75          | RoHS & Green     | NIPDAU                               | Level-1-260C-UNLIM   | 0 to 70      | 2462C                   | <a href="#">Samples</a> |
| TLV2462CDG4      | LIFEBUY       | SOIC         | D               | 8    | 75          | RoHS & Green     | NIPDAU                               | Level-1-260C-UNLIM   | 0 to 70      | 2462C                   |                         |
| TLV2462CDGK      | ACTIVE        | VSSOP        | DGK             | 8    | 80          | RoHS & Green     | NIPDAU   NIPDAUAG                    | Level-1-260C-UNLIM   | 0 to 70      | AAI                     | <a href="#">Samples</a> |
| TLV2462CDGKR     | ACTIVE        | VSSOP        | DGK             | 8    | 2500        | RoHS & Green     | NIPDAU   NIPDAUAG                    | Level-1-260C-UNLIM   | 0 to 70      | AAI                     | <a href="#">Samples</a> |
| TLV2462CDGKRG4   | LIFEBUY       | VSSOP        | DGK             | 8    | 2500        | RoHS & Green     | NIPDAU                               | Level-1-260C-UNLIM   | 0 to 70      | AAI                     |                         |
| TLV2462CDR       | ACTIVE        | SOIC         | D               | 8    | 2500        | RoHS & Green     | NIPDAU                               | Level-1-260C-UNLIM   | 0 to 70      | 2462C                   | <a href="#">Samples</a> |
| TLV2462CDRG4     | LIFEBUY       | SOIC         | D               | 8    | 2500        | RoHS & Green     | NIPDAU                               | Level-1-260C-UNLIM   | 0 to 70      | 2462C                   |                         |
| TLV2462CP        | ACTIVE        | PDIP         | P               | 8    | 50          | RoHS & Green     | NIPDAU                               | N / A for Pkg Type   | 0 to 70      | TLV2462CP               | <a href="#">Samples</a> |
| TLV2462CPE4      | LIFEBUY       | PDIP         | P               | 8    | 50          | RoHS & Green     | NIPDAU                               | N / A for Pkg Type   | 0 to 70      | TLV2462CP               |                         |
| TLV2462ID        | ACTIVE        | SOIC         | D               | 8    | 75          | RoHS & Green     | NIPDAU                               | Level-1-260C-UNLIM   | -40 to 125   | 2462I                   | <a href="#">Samples</a> |
| TLV2462IDG4      | LIFEBUY       | SOIC         | D               | 8    | 75          | RoHS & Green     | NIPDAU                               | Level-1-260C-UNLIM   | -40 to 125   | 2462I                   |                         |
| TLV2462IDGK      | ACTIVE        | VSSOP        | DGK             | 8    | 80          | RoHS & Green     | NIPDAU   NIPDAUAG                    | Level-1-260C-UNLIM   | -40 to 125   | AAJ                     | <a href="#">Samples</a> |
| TLV2462IDGKG4    | LIFEBUY       | VSSOP        | DGK             | 8    | 80          | RoHS & Green     | NIPDAU                               | Level-1-260C-UNLIM   | -40 to 125   | AAJ                     |                         |
| TLV2462IDGKR     | ACTIVE        | VSSOP        | DGK             | 8    | 2500        | RoHS & Green     | NIPDAU   NIPDAUAG                    | Level-1-260C-UNLIM   | -40 to 125   | AAJ                     | <a href="#">Samples</a> |
| TLV2462IDR       | ACTIVE        | SOIC         | D               | 8    | 2500        | RoHS & Green     | NIPDAU                               | Level-1-260C-UNLIM   | -40 to 125   | 2462I                   | <a href="#">Samples</a> |

| Orderable Device | Status<br>(1) | Package Type | Package Drawing | Pins | Package Qty | Eco Plan<br>(2)  | Lead finish/<br>Ball material<br>(6) | MSL Peak Temp<br>(3) | Op Temp (°C) | Device Marking<br>(4/5) | Samples                 |
|------------------|---------------|--------------|-----------------|------|-------------|------------------|--------------------------------------|----------------------|--------------|-------------------------|-------------------------|
| TLV2462IP        | ACTIVE        | PDIP         | P               | 8    | 50          | RoHS & Green     | NIPDAU                               | N / A for Pkg Type   | -40 to 125   | TLV2462IP               | <a href="#">Samples</a> |
| TLV2462MUB       | ACTIVE        | CFP          | U               | 10   | 1           | Non-RoHS & Green | SNPB                                 | N / A for Pkg Type   | -55 to 125   | 0051205QHA<br>TLV2462M  | <a href="#">Samples</a> |
| TLV2462QPWR      | ACTIVE        | TSSOP        | PW              | 8    | 2000        | RoHS & Green     | NIPDAU                               | Level-1-260C-UNLIM   | -40 to 125   | V2462Q                  | <a href="#">Samples</a> |
| TLV2462QPWRG4    | ACTIVE        | TSSOP        | PW              | 8    | 2000        | RoHS & Green     | NIPDAU                               | Level-1-260C-UNLIM   |              | V2462Q                  | <a href="#">Samples</a> |
| TLV2463AIDR      | ACTIVE        | SOIC         | D               | 14   | 2500        | RoHS & Green     | NIPDAU                               | Level-1-260C-UNLIM   | -40 to 125   | TLV2463AI               | <a href="#">Samples</a> |
| TLV2463AMJ       | ACTIVE        | CDIP         | J               | 14   | 1           | Non-RoHS & Green | SNPB                                 | N / A for Pkg Type   | -55 to 125   | TLV2463AMJ              | <a href="#">Samples</a> |
| TLV2463CD        | ACTIVE        | SOIC         | D               | 14   | 50          | RoHS & Green     | NIPDAU                               | Level-1-260C-UNLIM   | 0 to 70      | TLV2463C                | <a href="#">Samples</a> |
| TLV2463CDGS      | ACTIVE        | VSSOP        | DGS             | 10   | 80          | RoHS & Green     | NIPDAU                               | Level-1-260C-UNLIM   | 0 to 70      | AAK                     | <a href="#">Samples</a> |
| TLV2463CDGSR     | ACTIVE        | VSSOP        | DGS             | 10   | 2500        | RoHS & Green     | NIPDAU                               | Level-1-260C-UNLIM   | 0 to 70      | AAK                     | <a href="#">Samples</a> |
| TLV2463CDGSRG4   | LIFEBUY       | VSSOP        | DGS             | 10   | 2500        | RoHS & Green     | NIPDAU                               | Level-1-260C-UNLIM   | 0 to 70      | AAK                     |                         |
| TLV2463CDR       | ACTIVE        | SOIC         | D               | 14   | 2500        | RoHS & Green     | NIPDAU                               | Level-1-260C-UNLIM   | 0 to 70      | TLV2463C                | <a href="#">Samples</a> |
| TLV2463CN        | ACTIVE        | PDIP         | N               | 14   | 25          | RoHS & Green     | NIPDAU                               | N / A for Pkg Type   | 0 to 70      | TLV2463CN               | <a href="#">Samples</a> |
| TLV2463ID        | ACTIVE        | SOIC         | D               | 14   | 50          | RoHS & Green     | NIPDAU                               | Level-1-260C-UNLIM   | -40 to 125   | TLV2463I                | <a href="#">Samples</a> |
| TLV2463IDGS      | ACTIVE        | VSSOP        | DGS             | 10   | 80          | RoHS & Green     | NIPDAU                               | Level-1-260C-UNLIM   | -40 to 125   | AAL                     | <a href="#">Samples</a> |
| TLV2463IDGSR     | ACTIVE        | VSSOP        | DGS             | 10   | 2500        | RoHS & Green     | NIPDAU                               | Level-1-260C-UNLIM   | -40 to 125   | AAL                     | <a href="#">Samples</a> |
| TLV2463IN        | ACTIVE        | PDIP         | N               | 14   | 25          | RoHS & Green     | NIPDAU                               | N / A for Pkg Type   | -40 to 125   | TLV2463IN               | <a href="#">Samples</a> |
| TLV2464AID       | ACTIVE        | SOIC         | D               | 14   | 50          | RoHS & Green     | NIPDAU                               | Level-1-260C-UNLIM   | -40 to 125   | 2464AI                  | <a href="#">Samples</a> |
| TLV2464AIDG4     | LIFEBUY       | SOIC         | D               | 14   | 50          | RoHS & Green     | NIPDAU                               | Level-1-260C-UNLIM   | -40 to 125   | 2464AI                  |                         |
| TLV2464AIDR      | ACTIVE        | SOIC         | D               | 14   | 2500        | RoHS & Green     | NIPDAU                               | Level-1-260C-UNLIM   | -40 to 125   | 2464AI                  | <a href="#">Samples</a> |
| TLV2464AIDRG4    | LIFEBUY       | SOIC         | D               | 14   | 2500        | RoHS & Green     | NIPDAU                               | Level-1-260C-UNLIM   | -40 to 125   | 2464AI                  |                         |
| TLV2464AIN       | ACTIVE        | PDIP         | N               | 14   | 25          | RoHS & Green     | NIPDAU                               | N / A for Pkg Type   | -40 to 125   | TLV2464AIN              | <a href="#">Samples</a> |
| TLV2464AIPW      | ACTIVE        | TSSOP        | PW              | 14   | 90          | RoHS & Green     | NIPDAU                               | Level-1-260C-UNLIM   | -40 to 125   | TY2464A                 | <a href="#">Samples</a> |

| Orderable Device | Status<br>(1) | Package Type | Package Drawing | Pins | Package Qty | Eco Plan<br>(2) | Lead finish/<br>Ball material<br>(6) | MSL Peak Temp<br>(3) | Op Temp (°C) | Device Marking<br>(4/5) | Samples                 |
|------------------|---------------|--------------|-----------------|------|-------------|-----------------|--------------------------------------|----------------------|--------------|-------------------------|-------------------------|
| TLV2464AIPWR     | ACTIVE        | TSSOP        | PW              | 14   | 2000        | RoHS & Green    | NIPDAU                               | Level-1-260C-UNLIM   | -40 to 125   | TY2464A                 | <a href="#">Samples</a> |
| TLV2464CD        | ACTIVE        | SOIC         | D               | 14   | 50          | RoHS & Green    | NIPDAU                               | Level-1-260C-UNLIM   | 0 to 70      | TLV2464C                | <a href="#">Samples</a> |
| TLV2464CDR       | ACTIVE        | SOIC         | D               | 14   | 2500        | RoHS & Green    | NIPDAU                               | Level-1-260C-UNLIM   | 0 to 70      | TLV2464C                | <a href="#">Samples</a> |
| TLV2464CN        | ACTIVE        | PDIP         | N               | 14   | 25          | RoHS & Green    | NIPDAU                               | N / A for Pkg Type   | 0 to 70      | TLV2464CN               | <a href="#">Samples</a> |
| TLV2464CNE4      | LIFEBUY       | PDIP         | N               | 14   | 25          | RoHS & Green    | NIPDAU                               | N / A for Pkg Type   | 0 to 70      | TLV2464CN               |                         |
| TLV2464CPW       | ACTIVE        | TSSOP        | PW              | 14   | 90          | RoHS & Green    | NIPDAU                               | Level-1-260C-UNLIM   | 0 to 70      | TV2464                  | <a href="#">Samples</a> |
| TLV2464CPWR      | ACTIVE        | TSSOP        | PW              | 14   | 2000        | RoHS & Green    | NIPDAU                               | Level-1-260C-UNLIM   | 0 to 70      | TV2464                  | <a href="#">Samples</a> |
| TLV2464ID        | ACTIVE        | SOIC         | D               | 14   | 50          | RoHS & Green    | NIPDAU                               | Level-1-260C-UNLIM   | -40 to 125   | TLV2464I                | <a href="#">Samples</a> |
| TLV2464IDG4      | LIFEBUY       | SOIC         | D               | 14   | 50          | RoHS & Green    | NIPDAU                               | Level-1-260C-UNLIM   | -40 to 125   | TLV2464I                |                         |
| TLV2464IDR       | ACTIVE        | SOIC         | D               | 14   | 2500        | RoHS & Green    | NIPDAU                               | Level-1-260C-UNLIM   | -40 to 125   | TLV2464I                | <a href="#">Samples</a> |
| TLV2464IN        | ACTIVE        | PDIP         | N               | 14   | 25          | RoHS & Green    | NIPDAU                               | N / A for Pkg Type   | -40 to 125   | TLV2464IN               | <a href="#">Samples</a> |
| TLV2464IPW       | ACTIVE        | TSSOP        | PW              | 14   | 90          | RoHS & Green    | NIPDAU                               | Level-1-260C-UNLIM   | -40 to 125   | TY2464                  | <a href="#">Samples</a> |
| TLV2464IPWR      | ACTIVE        | TSSOP        | PW              | 14   | 2000        | RoHS & Green    | NIPDAU                               | Level-1-260C-UNLIM   | -40 to 125   | TY2464                  | <a href="#">Samples</a> |
| TLV2464IPWRG4    | LIFEBUY       | TSSOP        | PW              | 14   | 2000        | RoHS & Green    | NIPDAU                               | Level-1-260C-UNLIM   | -40 to 125   | TY2464                  |                         |
| TLV2465CD        | ACTIVE        | SOIC         | D               | 16   | 40          | RoHS & Green    | NIPDAU                               | Level-1-260C-UNLIM   | 0 to 70      | TLV2465C                | <a href="#">Samples</a> |
| TLV2465CDR       | ACTIVE        | SOIC         | D               | 16   | 2500        | RoHS & Green    | NIPDAU                               | Level-1-260C-UNLIM   | 0 to 70      | TLV2465C                | <a href="#">Samples</a> |
| TLV2465CPWR      | ACTIVE        | TSSOP        | PW              | 16   | 2000        | RoHS & Green    | NIPDAU                               | Level-1-260C-UNLIM   | 0 to 70      | 2465C                   | <a href="#">Samples</a> |
| TLV2465ID        | ACTIVE        | SOIC         | D               | 16   | 40          | RoHS & Green    | NIPDAU                               | Level-1-260C-UNLIM   | -40 to 125   | TLV2465I                | <a href="#">Samples</a> |
| TLV2465IDR       | ACTIVE        | SOIC         | D               | 16   | 2500        | RoHS & Green    | NIPDAU                               | Level-1-260C-UNLIM   | -40 to 125   | TLV2465I                | <a href="#">Samples</a> |
| TLV2465IN        | ACTIVE        | PDIP         | N               | 16   | 25          | RoHS & Green    | NIPDAU                               | N / A for Pkg Type   | -40 to 125   | TLV2465IN               | <a href="#">Samples</a> |
| TLV2465IPW       | ACTIVE        | TSSOP        | PW              | 16   | 90          | RoHS & Green    | NIPDAU                               | Level-1-260C-UNLIM   | -40 to 125   | 2465I                   | <a href="#">Samples</a> |
| TLV2465IPWR      | ACTIVE        | TSSOP        | PW              | 16   | 2000        | RoHS & Green    | NIPDAU                               | Level-1-260C-UNLIM   | -40 to 125   | 2465I                   | <a href="#">Samples</a> |

(1) The marketing status values are defined as follows:

**ACTIVE:** Product device recommended for new designs.

**LIFEBUY:** TI has announced that the device will be discontinued, and a lifetime-buy period is in effect.

**NRND:** Not recommended for new designs. Device is in production to support existing customers, but TI does not recommend using this part in a new design.

**PREVIEW:** Device has been announced but is not in production. Samples may or may not be available.

**OBSOLETE:** TI has discontinued the production of the device.

(2) **RoHS:** TI defines "RoHS" to mean semiconductor products that are compliant with the current EU RoHS requirements for all 10 RoHS substances, including the requirement that RoHS substance do not exceed 0.1% by weight in homogeneous materials. Where designed to be soldered at high temperatures, "RoHS" products are suitable for use in specified lead-free processes. TI may reference these types of products as "Pb-Free".

**RoHS Exempt:** TI defines "RoHS Exempt" to mean products that contain lead but are compliant with EU RoHS pursuant to a specific EU RoHS exemption.

**Green:** TI defines "Green" to mean the content of Chlorine (Cl) and Bromine (Br) based flame retardants meet JS709B low halogen requirements of  $\leq 1000$ ppm threshold. Antimony trioxide based flame retardants must also meet the  $\leq 1000$ ppm threshold requirement.

(3) MSL, Peak Temp. - The Moisture Sensitivity Level rating according to the JEDEC industry standard classifications, and peak solder temperature.

(4) There may be additional marking, which relates to the logo, the lot trace code information, or the environmental category on the device.

(5) Multiple Device Markings will be inside parentheses. Only one Device Marking contained in parentheses and separated by a "~" will appear on a device. If a line is indented then it is a continuation of the previous line and the two combined represent the entire Device Marking for that device.

(6) Lead finish/Ball material - Orderable Devices may have multiple material finish options. Finish options are separated by a vertical ruled line. Lead finish/Ball material values may wrap to two lines if the finish value exceeds the maximum column width.

**Important Information and Disclaimer:**The information provided on this page represents TI's knowledge and belief as of the date that it is provided. TI bases its knowledge and belief on information provided by third parties, and makes no representation or warranty as to the accuracy of such information. Efforts are underway to better integrate information from third parties. TI has taken and continues to take reasonable steps to provide representative and accurate information but may not have conducted destructive testing or chemical analysis on incoming materials and chemicals. TI and TI suppliers consider certain information to be proprietary, and thus CAS numbers and other limited information may not be available for release.

In no event shall TI's liability arising out of such information exceed the total purchase price of the TI part(s) at issue in this document sold by TI to Customer on an annual basis.

**OTHER QUALIFIED VERSIONS OF TLV2460, TLV2460A, TLV2460M, TLV2461, TLV2461A, TLV2461M, TLV2462, TLV2462A, TLV2462AM, TLV2462M, TLV2463A, TLV2463AM, TLV2464A :**

● Catalog : [TLV2460](#), [TLV2461](#), [TLV2462A](#), [TLV2462](#), [TLV2463A](#)

● Automotive : [TLV2460A-Q1](#), [TLV2461A-Q1](#), [TLV2462-Q1](#), [TLV2462A-Q1](#), [TLV2462A-Q1](#), [TLV2462-Q1](#), [TLV2463A-Q1](#), [TLV2463A-Q1](#), [TLV2464A-Q1](#)

● Enhanced Product : [TLV2462A-EP](#), [TLV2462A-EP](#), [TLV2464A-EP](#)

- Military : [TLV2460M](#), [TLV2461M](#), [TLV2462M](#), [TLV2462AM](#), [TLV2463AM](#)

NOTE: Qualified Version Definitions:

- Catalog - TI's standard catalog product
- Automotive - Q100 devices qualified for high-reliability automotive applications targeting zero defects
- Enhanced Product - Supports Defense, Aerospace and Medical Applications
- Military - QML certified for Military and Defense Applications

**TAPE AND REEL INFORMATION**

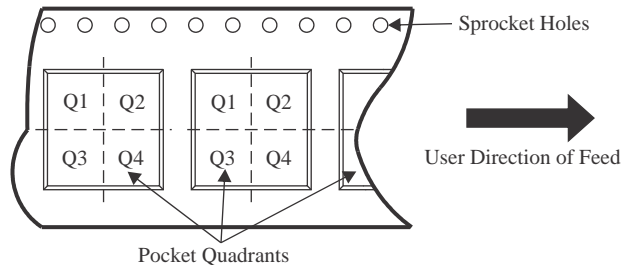
**QUADRANT ASSIGNMENTS FOR PIN 1 ORIENTATION IN TAPE**

\*All dimensions are nominal

| Device       | Package Type | Package Drawing | Pins | SPQ  | Reel Diameter (mm) | Reel Width W1 (mm) | A0 (mm) | B0 (mm) | K0 (mm) | P1 (mm) | W (mm) | Pin1 Quadrant |
|--------------|--------------|-----------------|------|------|--------------------|--------------------|---------|---------|---------|---------|--------|---------------|
| TLV2460AIDR  | SOIC         | D               | 8    | 2500 | 330.0              | 12.4               | 6.4     | 5.2     | 2.1     | 8.0     | 12.0   | Q1            |
| TLV2460CDBVR | SOT-23       | DBV             | 6    | 3000 | 178.0              | 9.0                | 3.23    | 3.17    | 1.37    | 4.0     | 8.0    | Q3            |
| TLV2460CDBVT | SOT-23       | DBV             | 6    | 250  | 178.0              | 9.0                | 3.23    | 3.17    | 1.37    | 4.0     | 8.0    | Q3            |
| TLV2460CDR   | SOIC         | D               | 8    | 2500 | 330.0              | 12.4               | 6.4     | 5.2     | 2.1     | 8.0     | 12.0   | Q1            |
| TLV2460IDBVR | SOT-23       | DBV             | 6    | 3000 | 178.0              | 9.0                | 3.23    | 3.17    | 1.37    | 4.0     | 8.0    | Q3            |
| TLV2460IDBVT | SOT-23       | DBV             | 6    | 250  | 178.0              | 9.0                | 3.23    | 3.17    | 1.37    | 4.0     | 8.0    | Q3            |
| TLV2460IDR   | SOIC         | D               | 8    | 2500 | 330.0              | 12.4               | 6.4     | 5.2     | 2.1     | 8.0     | 12.0   | Q1            |
| TLV2461AIDR  | SOIC         | D               | 8    | 2500 | 330.0              | 12.4               | 6.4     | 5.2     | 2.1     | 8.0     | 12.0   | Q1            |
| TLV2461CDBVR | SOT-23       | DBV             | 5    | 3000 | 178.0              | 9.0                | 3.3     | 3.2     | 1.4     | 4.0     | 8.0    | Q3            |
| TLV2461CDBVT | SOT-23       | DBV             | 5    | 250  | 178.0              | 9.0                | 3.23    | 3.17    | 1.37    | 4.0     | 8.0    | Q3            |
| TLV2461CDR   | SOIC         | D               | 8    | 2500 | 330.0              | 12.4               | 6.4     | 5.2     | 2.1     | 8.0     | 12.0   | Q1            |
| TLV2461IDBVR | SOT-23       | DBV             | 5    | 3000 | 178.0              | 9.0                | 3.3     | 3.2     | 1.4     | 4.0     | 8.0    | Q3            |
| TLV2461IDBVT | SOT-23       | DBV             | 5    | 250  | 178.0              | 9.0                | 3.3     | 3.2     | 1.4     | 4.0     | 8.0    | Q3            |
| TLV2461IDR   | SOIC         | D               | 8    | 2500 | 330.0              | 12.4               | 6.4     | 5.2     | 2.1     | 8.0     | 12.0   | Q1            |
| TLV2462AIDR  | SOIC         | D               | 8    | 2500 | 330.0              | 12.4               | 6.4     | 5.2     | 2.1     | 8.0     | 12.0   | Q1            |
| TLV2462AQPWR | TSSOP        | PW              | 8    | 2000 | 330.0              | 12.4               | 7.0     | 3.6     | 1.6     | 8.0     | 12.0   | Q1            |

| Device        | Package Type | Package Drawing | Pins | SPQ  | Reel Diameter (mm) | Reel Width W1 (mm) | A0 (mm) | B0 (mm) | K0 (mm) | P1 (mm) | W (mm) | Pin1 Quadrant |
|---------------|--------------|-----------------|------|------|--------------------|--------------------|---------|---------|---------|---------|--------|---------------|
| TLV2462CDGKR  | VSSOP        | DGK             | 8    | 2500 | 330.0              | 12.4               | 5.3     | 3.4     | 1.4     | 8.0     | 12.0   | Q1            |
| TLV2462CDGKR  | VSSOP        | DGK             | 8    | 2500 | 330.0              | 12.4               | 5.3     | 3.4     | 1.4     | 8.0     | 12.0   | Q1            |
| TLV2462CDR    | SOIC         | D               | 8    | 2500 | 330.0              | 12.4               | 6.4     | 5.2     | 2.1     | 8.0     | 12.0   | Q1            |
| TLV2462IDGKR  | VSSOP        | DGK             | 8    | 2500 | 330.0              | 12.4               | 5.3     | 3.4     | 1.4     | 8.0     | 12.0   | Q1            |
| TLV2462IDGKR  | VSSOP        | DGK             | 8    | 2500 | 330.0              | 12.4               | 5.3     | 3.4     | 1.4     | 8.0     | 12.0   | Q1            |
| TLV2462IDR    | SOIC         | D               | 8    | 2500 | 330.0              | 12.4               | 6.4     | 5.2     | 2.1     | 8.0     | 12.0   | Q1            |
| TLV2462QPWR   | TSSOP        | PW              | 8    | 2000 | 330.0              | 12.4               | 7.0     | 3.6     | 1.6     | 8.0     | 12.0   | Q1            |
| TLV2462QPWRG4 | TSSOP        | PW              | 8    | 2000 | 330.0              | 12.4               | 7.0     | 3.6     | 1.6     | 8.0     | 12.0   | Q1            |
| TLV2463AIDR   | SOIC         | D               | 14   | 2500 | 330.0              | 16.4               | 6.5     | 9.0     | 2.1     | 8.0     | 16.0   | Q1            |
| TLV2463CDGSR  | VSSOP        | DGS             | 10   | 2500 | 330.0              | 12.4               | 5.3     | 3.4     | 1.4     | 8.0     | 12.0   | Q1            |
| TLV2463CDR    | SOIC         | D               | 14   | 2500 | 330.0              | 16.4               | 6.5     | 9.0     | 2.1     | 8.0     | 16.0   | Q1            |
| TLV2463IDGSR  | VSSOP        | DGS             | 10   | 2500 | 330.0              | 12.4               | 5.3     | 3.4     | 1.4     | 8.0     | 12.0   | Q1            |
| TLV2464AIDR   | SOIC         | D               | 14   | 2500 | 330.0              | 16.4               | 6.5     | 9.0     | 2.1     | 8.0     | 16.0   | Q1            |
| TLV2464AIPWR  | TSSOP        | PW              | 14   | 2000 | 330.0              | 12.4               | 6.9     | 5.6     | 1.6     | 8.0     | 12.0   | Q1            |
| TLV2464CDR    | SOIC         | D               | 14   | 2500 | 330.0              | 16.4               | 6.5     | 9.0     | 2.1     | 8.0     | 16.0   | Q1            |
| TLV2464CPWR   | TSSOP        | PW              | 14   | 2000 | 330.0              | 12.4               | 6.9     | 5.6     | 1.6     | 8.0     | 12.0   | Q1            |
| TLV2464IDR    | SOIC         | D               | 14   | 2500 | 330.0              | 16.4               | 6.5     | 9.0     | 2.1     | 8.0     | 16.0   | Q1            |
| TLV2464IPWR   | TSSOP        | PW              | 14   | 2000 | 330.0              | 12.4               | 6.9     | 5.6     | 1.6     | 8.0     | 12.0   | Q1            |
| TLV2465CDR    | SOIC         | D               | 16   | 2500 | 330.0              | 16.4               | 6.5     | 10.3    | 2.1     | 8.0     | 16.0   | Q1            |
| TLV2465CPWR   | TSSOP        | PW              | 16   | 2000 | 330.0              | 12.4               | 6.9     | 5.6     | 1.6     | 8.0     | 12.0   | Q1            |
| TLV2465IDR    | SOIC         | D               | 16   | 2500 | 330.0              | 16.4               | 6.5     | 10.3    | 2.1     | 8.0     | 16.0   | Q1            |
| TLV2465IPWR   | TSSOP        | PW              | 16   | 2000 | 330.0              | 12.4               | 6.9     | 5.6     | 1.6     | 8.0     | 12.0   | Q1            |

**TAPE AND REEL BOX DIMENSIONS**

\*All dimensions are nominal

| Device       | Package Type | Package Drawing | Pins | SPQ  | Length (mm) | Width (mm) | Height (mm) |
|--------------|--------------|-----------------|------|------|-------------|------------|-------------|
| TLV2460AIDR  | SOIC         | D               | 8    | 2500 | 340.5       | 336.1      | 25.0        |
| TLV2460CDBVR | SOT-23       | DBV             | 6    | 3000 | 180.0       | 180.0      | 18.0        |
| TLV2460CDBVT | SOT-23       | DBV             | 6    | 250  | 180.0       | 180.0      | 18.0        |
| TLV2460CDR   | SOIC         | D               | 8    | 2500 | 340.5       | 336.1      | 25.0        |
| TLV2460IDBVR | SOT-23       | DBV             | 6    | 3000 | 180.0       | 180.0      | 18.0        |
| TLV2460IDBVT | SOT-23       | DBV             | 6    | 250  | 180.0       | 180.0      | 18.0        |
| TLV2460IDR   | SOIC         | D               | 8    | 2500 | 340.5       | 336.1      | 25.0        |
| TLV2461AIDR  | SOIC         | D               | 8    | 2500 | 340.5       | 336.1      | 25.0        |
| TLV2461CDBVR | SOT-23       | DBV             | 5    | 3000 | 180.0       | 180.0      | 18.0        |
| TLV2461CDBVT | SOT-23       | DBV             | 5    | 250  | 180.0       | 180.0      | 18.0        |
| TLV2461CDR   | SOIC         | D               | 8    | 2500 | 340.5       | 336.1      | 25.0        |
| TLV2461IDBVR | SOT-23       | DBV             | 5    | 3000 | 180.0       | 180.0      | 18.0        |
| TLV2461IDBVT | SOT-23       | DBV             | 5    | 250  | 180.0       | 180.0      | 18.0        |
| TLV2461IDR   | SOIC         | D               | 8    | 2500 | 340.5       | 336.1      | 25.0        |
| TLV2462AIDR  | SOIC         | D               | 8    | 2500 | 340.5       | 336.1      | 25.0        |
| TLV2462AQPWR | TSSOP        | PW              | 8    | 2000 | 356.0       | 356.0      | 35.0        |
| TLV2462CDGKR | VSSOP        | DGK             | 8    | 2500 | 358.0       | 335.0      | 35.0        |
| TLV2462CDGKR | VSSOP        | DGK             | 8    | 2500 | 364.0       | 364.0      | 27.0        |

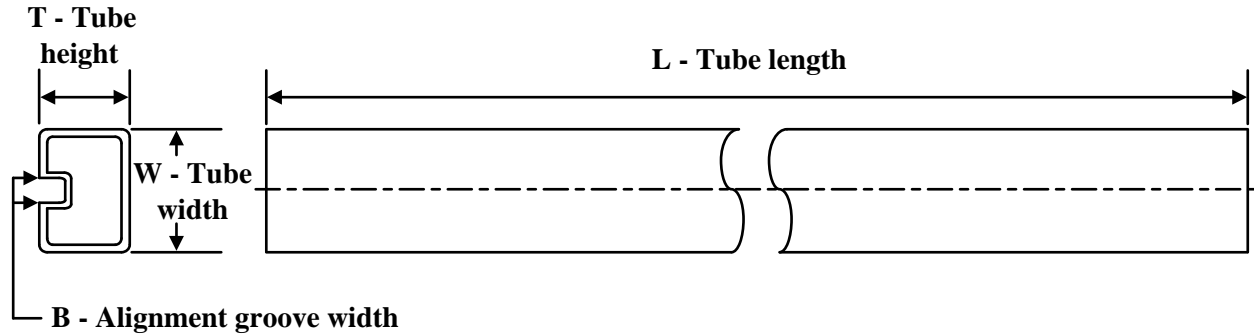

| Device        | Package Type | Package Drawing | Pins | SPQ  | Length (mm) | Width (mm) | Height (mm) |
|---------------|--------------|-----------------|------|------|-------------|------------|-------------|
| TLV2462CDR    | SOIC         | D               | 8    | 2500 | 340.5       | 336.1      | 25.0        |
| TLV2462IDGKR  | VSSOP        | DGK             | 8    | 2500 | 358.0       | 335.0      | 35.0        |
| TLV2462IDGKR  | VSSOP        | DGK             | 8    | 2500 | 364.0       | 364.0      | 27.0        |
| TLV2462IDR    | SOIC         | D               | 8    | 2500 | 340.5       | 336.1      | 25.0        |
| TLV2462QPWR   | TSSOP        | PW              | 8    | 2000 | 356.0       | 356.0      | 35.0        |
| TLV2462QPWRG4 | TSSOP        | PW              | 8    | 2000 | 356.0       | 356.0      | 35.0        |
| TLV2463AIDR   | SOIC         | D               | 14   | 2500 | 350.0       | 350.0      | 43.0        |
| TLV2463CDGSR  | VSSOP        | DGS             | 10   | 2500 | 358.0       | 335.0      | 35.0        |
| TLV2463CDR    | SOIC         | D               | 14   | 2500 | 350.0       | 350.0      | 43.0        |
| TLV2463IDGSR  | VSSOP        | DGS             | 10   | 2500 | 358.0       | 335.0      | 35.0        |
| TLV2464AIDR   | SOIC         | D               | 14   | 2500 | 340.5       | 336.1      | 32.0        |
| TLV2464AIPWR  | TSSOP        | PW              | 14   | 2000 | 356.0       | 356.0      | 35.0        |
| TLV2464CDR    | SOIC         | D               | 14   | 2500 | 340.5       | 336.1      | 32.0        |
| TLV2464CPWR   | TSSOP        | PW              | 14   | 2000 | 356.0       | 356.0      | 35.0        |
| TLV2464IDR    | SOIC         | D               | 14   | 2500 | 340.5       | 336.1      | 32.0        |
| TLV2464IPWR   | TSSOP        | PW              | 14   | 2000 | 356.0       | 356.0      | 35.0        |
| TLV2465CDR    | SOIC         | D               | 16   | 2500 | 350.0       | 350.0      | 43.0        |
| TLV2465CPWR   | TSSOP        | PW              | 16   | 2000 | 356.0       | 356.0      | 35.0        |
| TLV2465IDR    | SOIC         | D               | 16   | 2500 | 350.0       | 350.0      | 43.0        |
| TLV2465IPWR   | TSSOP        | PW              | 16   | 2000 | 356.0       | 356.0      | 35.0        |

**TUBE**

\*All dimensions are nominal

| Device          | Package Name | Package Type | Pins | SPQ | L (mm) | W (mm) | T (µm) | B (mm) |
|-----------------|--------------|--------------|------|-----|--------|--------|--------|--------|
| 5962-0051201QHA | U            | CFP          | 10   | 1   | 506.98 | 26.16  | 6220   | NA     |
| 5962-0051203QHA | U            | CFP          | 10   | 1   | 506.98 | 26.16  | 6220   | NA     |
| 5962-0051205QHA | U            | CFP          | 10   | 1   | 506.98 | 26.16  | 6220   | NA     |
| 5962-0051206Q2A | FK           | LCCC         | 20   | 1   | 506.98 | 12.06  | 2030   | NA     |
| 5962-0051206QHA | U            | CFP          | 10   | 1   | 506.98 | 26.16  | 6220   | NA     |
| TLV2460AIP      | P            | PDIP         | 8    | 50  | 506    | 13.97  | 11230  | 4.32   |
| TLV2460CD       | D            | SOIC         | 8    | 75  | 507    | 8      | 3940   | 4.32   |
| TLV2460CD       | D            | SOIC         | 8    | 75  | 505.46 | 6.76   | 3810   | 4      |
| TLV2460CP       | P            | PDIP         | 8    | 50  | 506    | 13.97  | 11230  | 4.32   |
| TLV2460ID       | D            | SOIC         | 8    | 75  | 507    | 8      | 3940   | 4.32   |
| TLV2460ID       | D            | SOIC         | 8    | 75  | 505.46 | 6.76   | 3810   | 4      |
| TLV2460IP       | P            | PDIP         | 8    | 50  | 506    | 13.97  | 11230  | 4.32   |
| TLV2460MUB      | U            | CFP          | 10   | 1   | 506.98 | 26.16  | 6220   | NA     |
| TLV2461AID      | D            | SOIC         | 8    | 75  | 507    | 8      | 3940   | 4.32   |
| TLV2461AID      | D            | SOIC         | 8    | 75  | 505.46 | 6.76   | 3810   | 4      |
| TLV2461AIP      | P            | PDIP         | 8    | 50  | 506    | 13.97  | 11230  | 4.32   |
| TLV2461CD       | D            | SOIC         | 8    | 75  | 507    | 8      | 3940   | 4.32   |
| TLV2461CD       | D            | SOIC         | 8    | 75  | 505.46 | 6.76   | 3810   | 4      |
| TLV2461CP       | P            | PDIP         | 8    | 50  | 506    | 13.97  | 11230  | 4.32   |
| TLV2461ID       | D            | SOIC         | 8    | 75  | 507    | 8      | 3940   | 4.32   |
| TLV2461ID       | D            | SOIC         | 8    | 75  | 505.46 | 6.76   | 3810   | 4      |
| TLV2461IP       | P            | PDIP         | 8    | 50  | 506    | 13.97  | 11230  | 4.32   |
| TLV2461MUB      | U            | CFP          | 10   | 1   | 506.98 | 26.16  | 6220   | NA     |
| TLV2462AID      | D            | SOIC         | 8    | 75  | 507    | 8      | 3940   | 4.32   |
| TLV2462AID      | D            | SOIC         | 8    | 75  | 505.46 | 6.76   | 3810   | 4      |
| TLV2462AIP      | P            | PDIP         | 8    | 50  | 506    | 13.97  | 11230  | 4.32   |
| TLV2462AMFKB    | FK           | LCCC         | 20   | 1   | 506.98 | 12.06  | 2030   | NA     |
| TLV2462AMUB     | U            | CFP          | 10   | 1   | 506.98 | 26.16  | 6220   | NA     |
| TLV2462AQD      | D            | SOIC         | 8    | 75  | 507    | 8      | 3940   | 4.32   |

| Device        | Package Name | Package Type | Pins | SPQ | L (mm) | W (mm) | T (µm) | B (mm) |
|---------------|--------------|--------------|------|-----|--------|--------|--------|--------|
| TLV2462AQDG4  | D            | SOIC         | 8    | 75  | 507    | 8      | 3940   | 4.32   |
| TLV2462CD     | D            | SOIC         | 8    | 75  | 505.46 | 6.76   | 3810   | 4      |
| TLV2462CD     | D            | SOIC         | 8    | 75  | 507    | 8      | 3940   | 4.32   |
| TLV2462CDG4   | D            | SOIC         | 8    | 75  | 505.46 | 6.76   | 3810   | 4      |
| TLV2462CDG4   | D            | SOIC         | 8    | 75  | 507    | 8      | 3940   | 4.32   |
| TLV2462CDGK   | DGK          | VSSOP        | 8    | 80  | 330    | 6.55   | 500    | 2.88   |
| TLV2462CP     | P            | PDIP         | 8    | 50  | 506    | 13.97  | 11230  | 4.32   |
| TLV2462CPE4   | P            | PDIP         | 8    | 50  | 506    | 13.97  | 11230  | 4.32   |
| TLV2462ID     | D            | SOIC         | 8    | 75  | 507    | 8      | 3940   | 4.32   |
| TLV2462ID     | D            | SOIC         | 8    | 75  | 505.46 | 6.76   | 3810   | 4      |
| TLV2462IDG4   | D            | SOIC         | 8    | 75  | 507    | 8      | 3940   | 4.32   |
| TLV2462IDG4   | D            | SOIC         | 8    | 75  | 505.46 | 6.76   | 3810   | 4      |
| TLV2462IDGK   | DGK          | VSSOP        | 8    | 80  | 330    | 6.55   | 500    | 2.88   |
| TLV2462IDGKG4 | DGK          | VSSOP        | 8    | 80  | 330    | 6.55   | 500    | 2.88   |
| TLV2462IP     | P            | PDIP         | 8    | 50  | 506    | 13.97  | 11230  | 4.32   |
| TLV2462MUB    | U            | CFP          | 10   | 1   | 506.98 | 26.16  | 6220   | NA     |
| TLV2463CD     | D            | SOIC         | 14   | 50  | 505.46 | 6.76   | 3810   | 4      |
| TLV2463CN     | N            | PDIP         | 14   | 25  | 506    | 13.97  | 11230  | 4.32   |
| TLV2463ID     | D            | SOIC         | 14   | 50  | 505.46 | 6.76   | 3810   | 4      |
| TLV2463IN     | N            | PDIP         | 14   | 25  | 506    | 13.97  | 11230  | 4.32   |
| TLV2464AID    | D            | SOIC         | 14   | 50  | 505.46 | 6.76   | 3810   | 4      |
| TLV2464AID    | D            | SOIC         | 14   | 50  | 507    | 8      | 3940   | 4.32   |
| TLV2464AIDG4  | D            | SOIC         | 14   | 50  | 507    | 8      | 3940   | 4.32   |
| TLV2464AIDG4  | D            | SOIC         | 14   | 50  | 505.46 | 6.76   | 3810   | 4      |
| TLV2464AIN    | N            | PDIP         | 14   | 25  | 506    | 13.97  | 11230  | 4.32   |
| TLV2464AIPW   | PW           | TSSOP        | 14   | 90  | 530    | 10.2   | 3600   | 3.5    |
| TLV2464CD     | D            | SOIC         | 14   | 50  | 507    | 8      | 3940   | 4.32   |
| TLV2464CD     | D            | SOIC         | 14   | 50  | 505.46 | 6.76   | 3810   | 4      |
| TLV2464CN     | N            | PDIP         | 14   | 25  | 506    | 13.97  | 11230  | 4.32   |
| TLV2464CNE4   | N            | PDIP         | 14   | 25  | 506    | 13.97  | 11230  | 4.32   |
| TLV2464CPW    | PW           | TSSOP        | 14   | 90  | 530    | 10.2   | 3600   | 3.5    |
| TLV2464ID     | D            | SOIC         | 14   | 50  | 507    | 8      | 3940   | 4.32   |
| TLV2464IDG4   | D            | SOIC         | 14   | 50  | 507    | 8      | 3940   | 4.32   |
| TLV2464IN     | N            | PDIP         | 14   | 25  | 506    | 13.97  | 11230  | 4.32   |
| TLV2464IPW    | PW           | TSSOP        | 14   | 90  | 530    | 10.2   | 3600   | 3.5    |
| TLV2465CD     | D            | SOIC         | 16   | 40  | 505.46 | 6.76   | 3810   | 4      |
| TLV2465ID     | D            | SOIC         | 16   | 40  | 505.46 | 6.76   | 3810   | 4      |
| TLV2465IN     | N            | PDIP         | 16   | 25  | 506    | 13.97  | 11230  | 4.32   |
| TLV2465IPW    | PW           | TSSOP        | 16   | 90  | 530    | 10.2   | 3600   | 3.5    |

D (R-PDSO-G16)

PLASTIC SMALL OUTLINE



- NOTES:
- A. All linear dimensions are in inches (millimeters).
  - B. This drawing is subject to change without notice.
  - C. Body length does not include mold flash, protrusions, or gate burrs. Mold flash, protrusions, or gate burrs shall not exceed 0.006 (0,15) each side.
  - D. Body width does not include interlead flash. Interlead flash shall not exceed 0.017 (0,43) each side.
  - E. Reference JEDEC MS-012 variation AC.

D (R-PDSO-G16)

PLASTIC SMALL OUTLINE

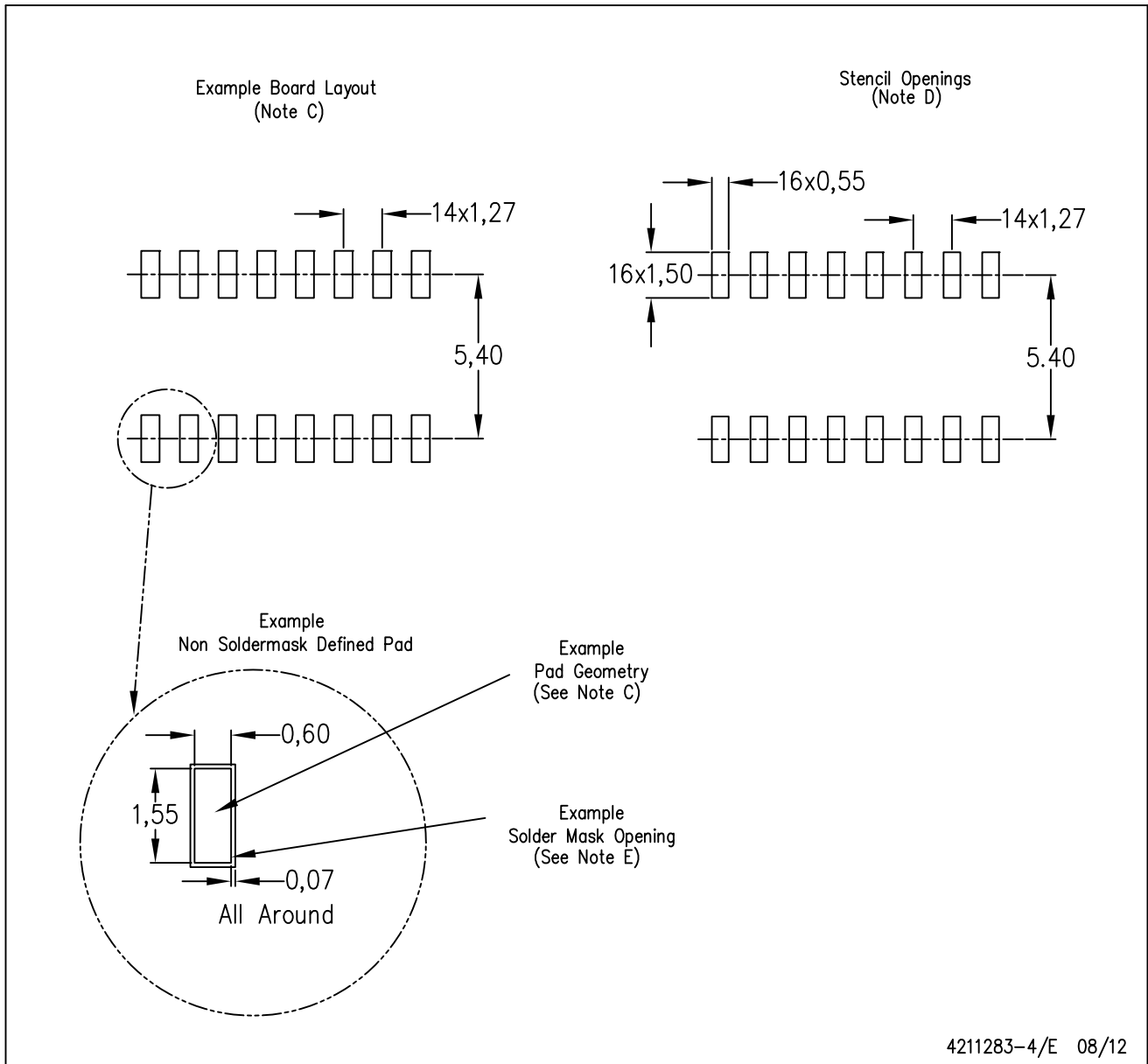

- NOTES:
- A. All linear dimensions are in millimeters.
  - B. This drawing is subject to change without notice.
  - C. Publication IPC-7351 is recommended for alternate designs.
  - D. Laser cutting apertures with trapezoidal walls and also rounding corners will offer better paste release. Customers should contact their board assembly site for stencil design recommendations. Refer to IPC-7525 for other stencil recommendations.
  - E. Customers should contact their board fabrication site for solder mask tolerances between and around signal pads.

# PW0016A



# PACKAGE OUTLINE

## TSSOP - 1.2 mm max height

SMALL OUTLINE PACKAGE



4220204/A 02/2017

### NOTES:

1. All linear dimensions are in millimeters. Any dimensions in parenthesis are for reference only. Dimensioning and tolerancing per ASME Y14.5M.
2. This drawing is subject to change without notice.
3. This dimension does not include mold flash, protrusions, or gate burrs. Mold flash, protrusions, or gate burrs shall not exceed 0.15 mm per side.
4. This dimension does not include interlead flash. Interlead flash shall not exceed 0.25 mm per side.
5. Reference JEDEC registration MO-153.

# EXAMPLE BOARD LAYOUT

PW0016A

TSSOP - 1.2 mm max height

SMALL OUTLINE PACKAGE



LAND PATTERN EXAMPLE  
EXPOSED METAL SHOWN  
SCALE: 10X

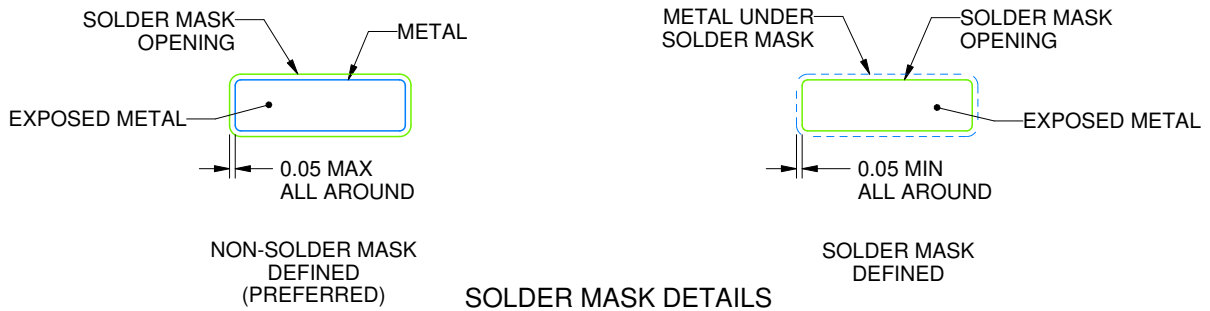

4220204/A 02/2017

NOTES: (continued)

- 6. Publication IPC-7351 may have alternate designs.
- 7. Solder mask tolerances between and around signal pads can vary based on board fabrication site.

# EXAMPLE STENCIL DESIGN

PW0016A

TSSOP - 1.2 mm max height

SMALL OUTLINE PACKAGE



SOLDER PASTE EXAMPLE  
BASED ON 0.125 mm THICK STENCIL  
SCALE: 10X

4220204/A 02/2017

NOTES: (continued)

8. Laser cutting apertures with trapezoidal walls and rounded corners may offer better paste release. IPC-7525 may have alternate design recommendations.
9. Board assembly site may have different recommendations for stencil design.



# DGS0010A



# PACKAGE OUTLINE

## VSSOP - 1.1 mm max height

SMALL OUTLINE PACKAGE

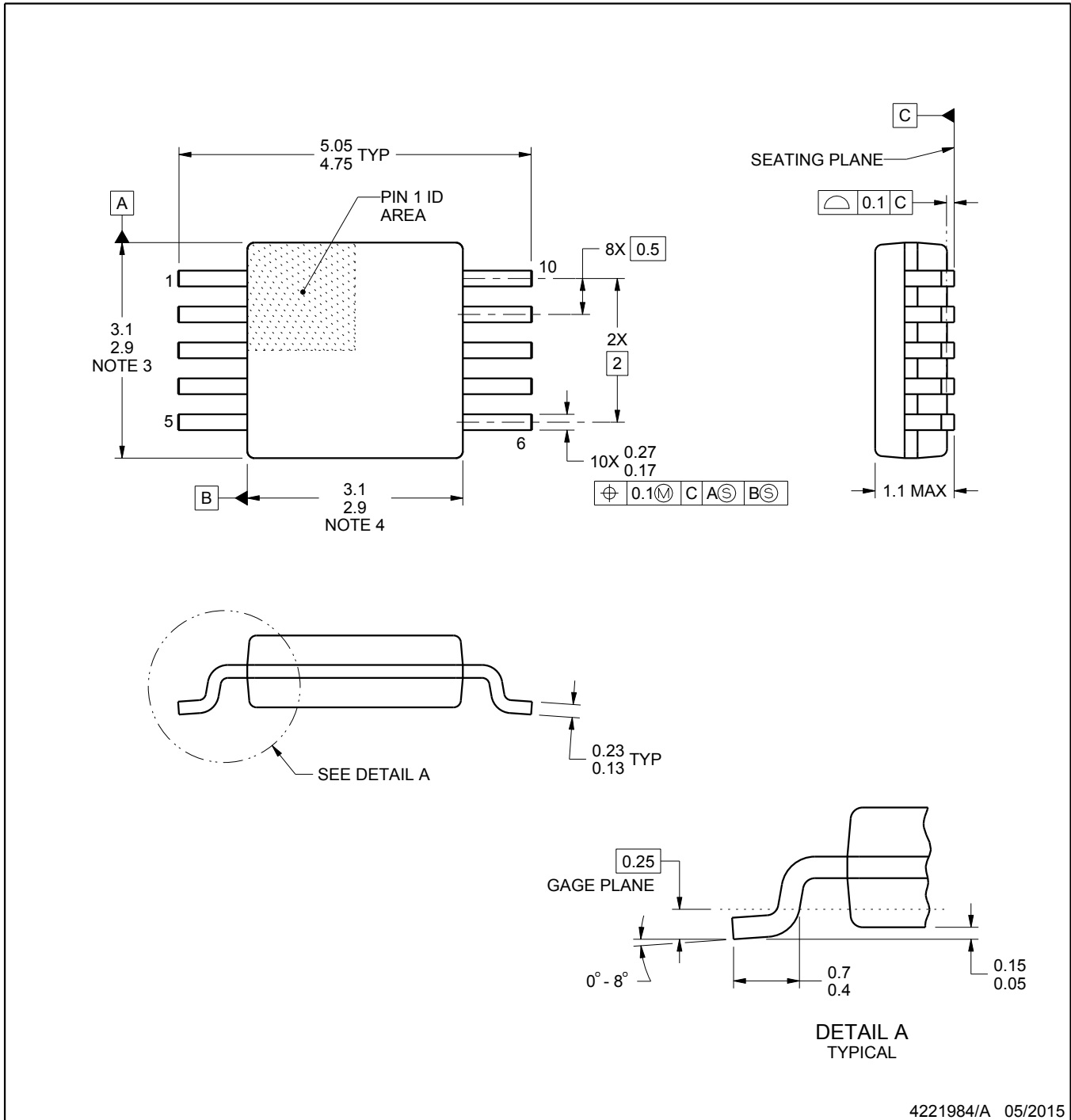

4221984/A 05/2015

### NOTES:

1. All linear dimensions are in millimeters. Any dimensions in parenthesis are for reference only. Dimensioning and tolerancing per ASME Y14.5M.
2. This drawing is subject to change without notice.
3. This dimension does not include mold flash, protrusions, or gate burrs. Mold flash, protrusions, or gate burrs shall not exceed 0.15 mm per side.
4. This dimension does not include interlead flash. Interlead flash shall not exceed 0.25 mm per side.
5. Reference JEDEC registration MO-187, variation BA.

# EXAMPLE BOARD LAYOUT

DGS0010A

VSSOP - 1.1 mm max height

SMALL OUTLINE PACKAGE

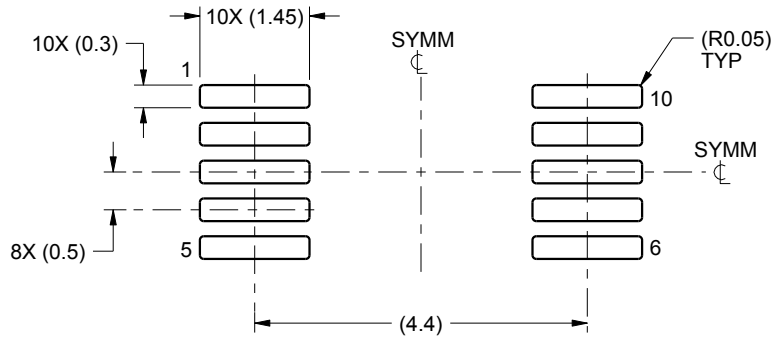

LAND PATTERN EXAMPLE  
SCALE:10X

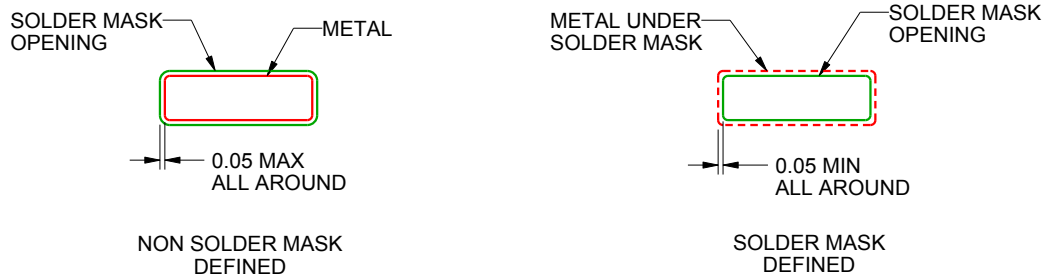

SOLDER MASK DETAILS  
NOT TO SCALE

4221984/A 05/2015

NOTES: (continued)

6. Publication IPC-7351 may have alternate designs.
7. Solder mask tolerances between and around signal pads can vary based on board fabrication site.

# EXAMPLE STENCIL DESIGN

DGS0010A

VSSOP - 1.1 mm max height

SMALL OUTLINE PACKAGE

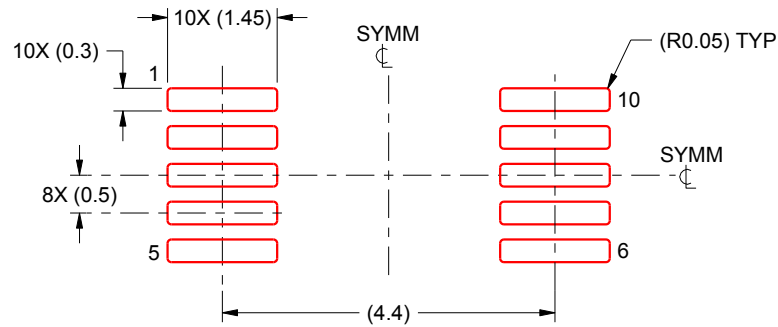

SOLDER PASTE EXAMPLE  
BASED ON 0.125 mm THICK STENCIL  
SCALE:10X

4221984/A 05/2015

NOTES: (continued)

8. Laser cutting apertures with trapezoidal walls and rounded corners may offer better paste release. IPC-7525 may have alternate design recommendations.
9. Board assembly site may have different recommendations for stencil design.

## GENERIC PACKAGE VIEW

**FK 20**

**LCCC - 2.03 mm max height**

8.89 x 8.89, 1.27 mm pitch

LEADLESS CERAMIC CHIP CARRIER

This image is a representation of the package family, actual package may vary.  
Refer to the product data sheet for package details.

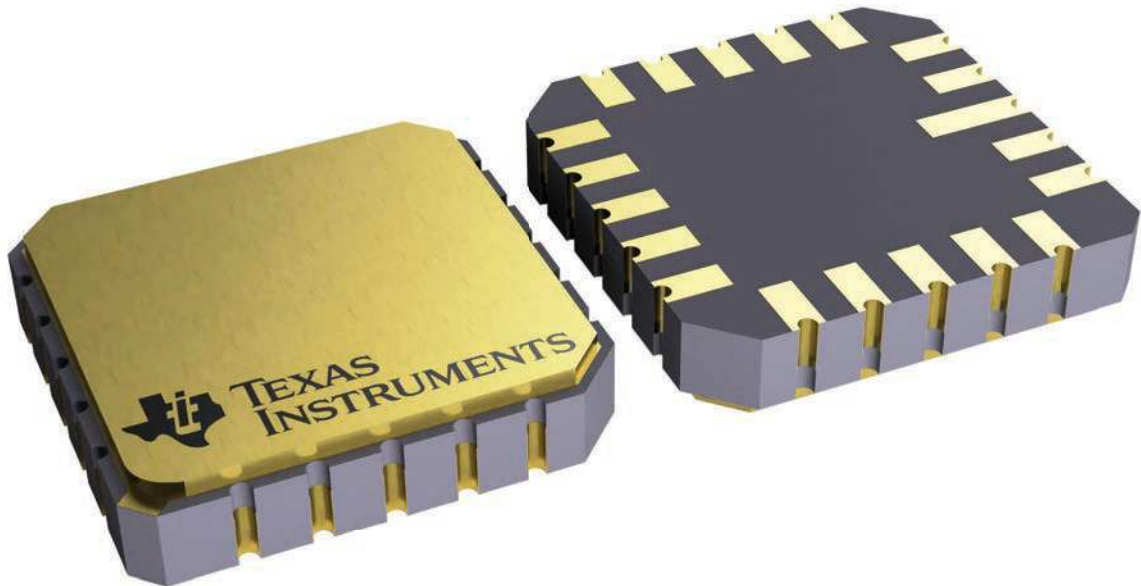

4229370VA\

J 14

**GENERIC PACKAGE VIEW**  
**CDIP - 5.08 mm max height**  
CERAMIC DUAL IN LINE PACKAGE



Images above are just a representation of the package family, actual package may vary.  
Refer to the product data sheet for package details.

4040083-5/G

J0014A



# PACKAGE OUTLINE

CDIP - 5.08 mm max height

CERAMIC DUAL IN LINE PACKAGE



4214771/A 05/2017

NOTES:

1. All controlling linear dimensions are in inches. Dimensions in brackets are in millimeters. Any dimension in brackets or parenthesis are for reference only. Dimensioning and tolerancing per ASME Y14.5M.
2. This drawing is subject to change without notice.
3. This package is hermetically sealed with a ceramic lid using glass frit.
4. Index point is provided on cap for terminal identification only and on press ceramic glass frit seal only.
5. Falls within MIL-STD-1835 and GDIP1-T14.

# EXAMPLE BOARD LAYOUT

J0014A

CDIP - 5.08 mm max height

CERAMIC DUAL IN LINE PACKAGE



LAND PATTERN EXAMPLE  
NON-SOLDER MASK DEFINED  
SCALE: 5X



4214771/A 05/2017





# EXAMPLE BOARD LAYOUT

DBV0005A

SOT-23 - 1.45 mm max height

SMALL OUTLINE TRANSISTOR

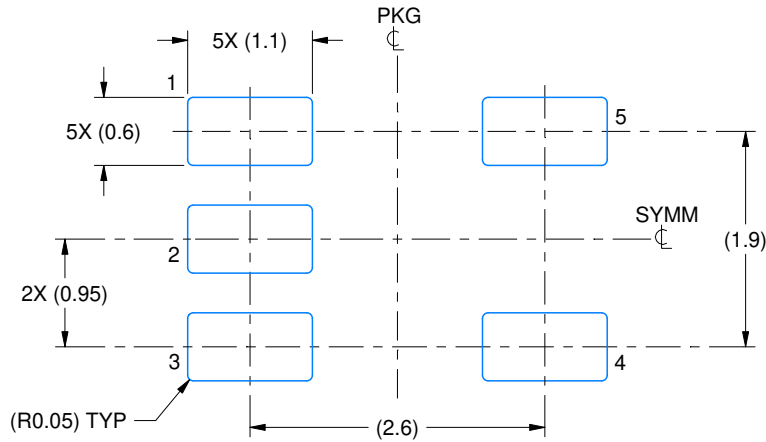

LAND PATTERN EXAMPLE  
EXPOSED METAL SHOWN  
SCALE:15X

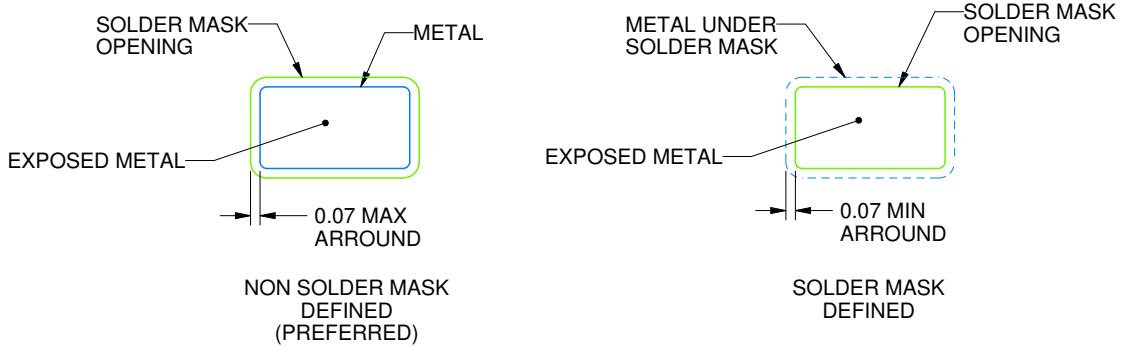

SOLDER MASK DETAILS

4214839/G 03/2023

NOTES: (continued)

- 6. Publication IPC-7351 may have alternate designs.
- 7. Solder mask tolerances between and around signal pads can vary based on board fabrication site.

# EXAMPLE STENCIL DESIGN

DBV0005A

SOT-23 - 1.45 mm max height

SMALL OUTLINE TRANSISTOR

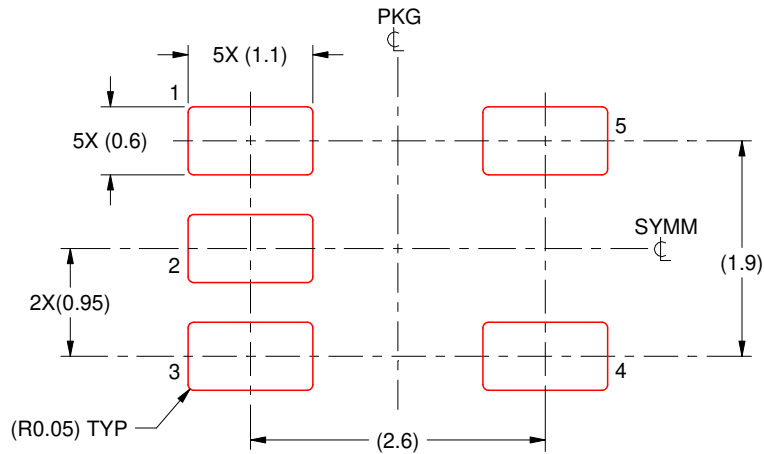

SOLDER PASTE EXAMPLE  
BASED ON 0.125 mm THICK STENCIL  
SCALE:15X

4214839/G 03/2023



NOTES: (continued)

8. Laser cutting apertures with trapezoidal walls and rounded corners may offer better paste release. IPC-7525 may have alternate design recommendations.
9. Board assembly site may have different recommendations for stencil design.

D (R-PDSO-G14)

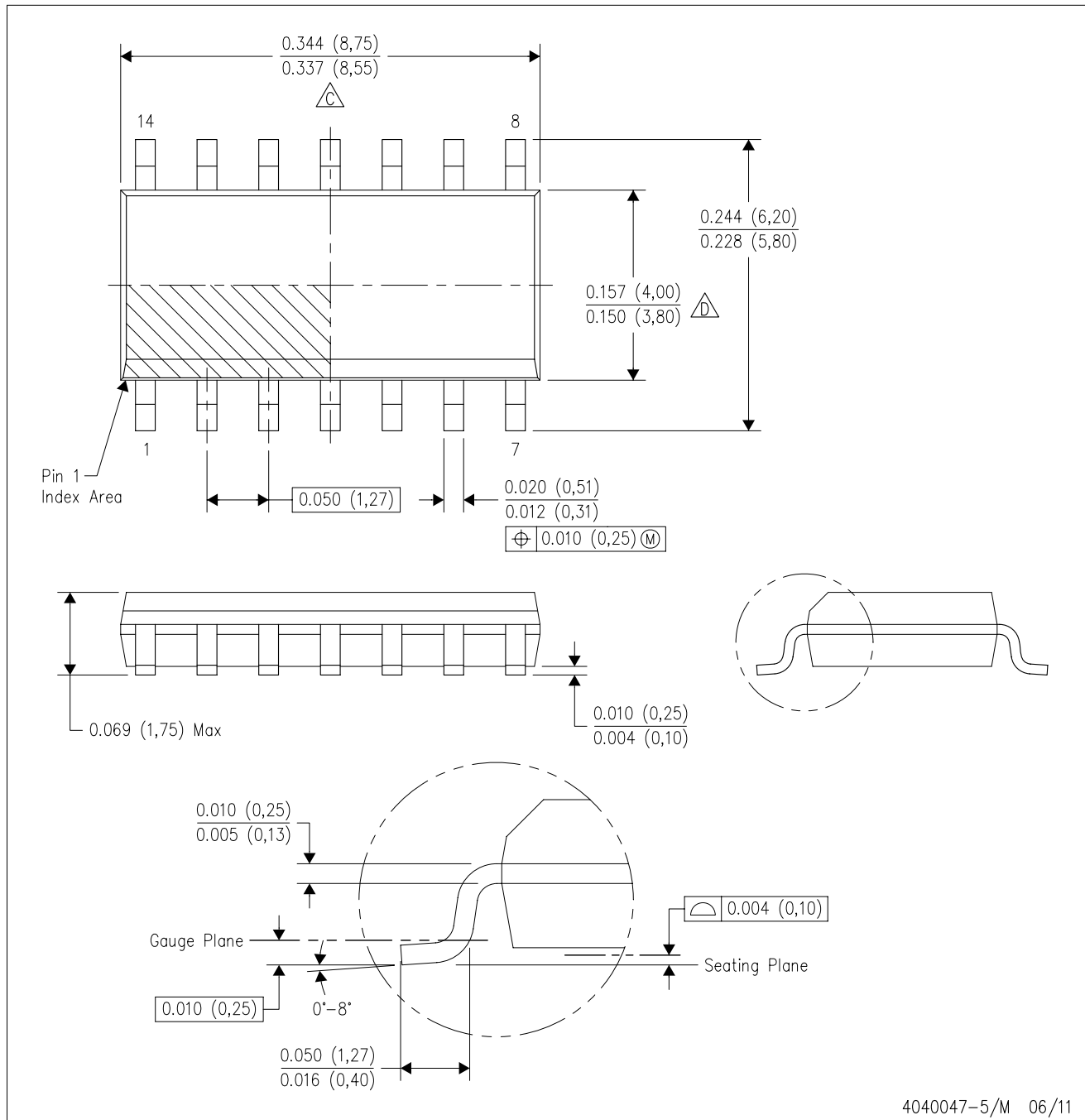
PLASTIC SMALL OUTLINE



- NOTES:
- A. All linear dimensions are in inches (millimeters).
  - B. This drawing is subject to change without notice.
  -  Body length does not include mold flash, protrusions, or gate burrs. Mold flash, protrusions, or gate burrs shall not exceed 0.006 (0,15) each side.
  -  Body width does not include interlead flash. Interlead flash shall not exceed 0.017 (0,43) each side.
  - E. Reference JEDEC MS-012 variation AB.

PW (R-PDSO-G14)

PLASTIC SMALL OUTLINE

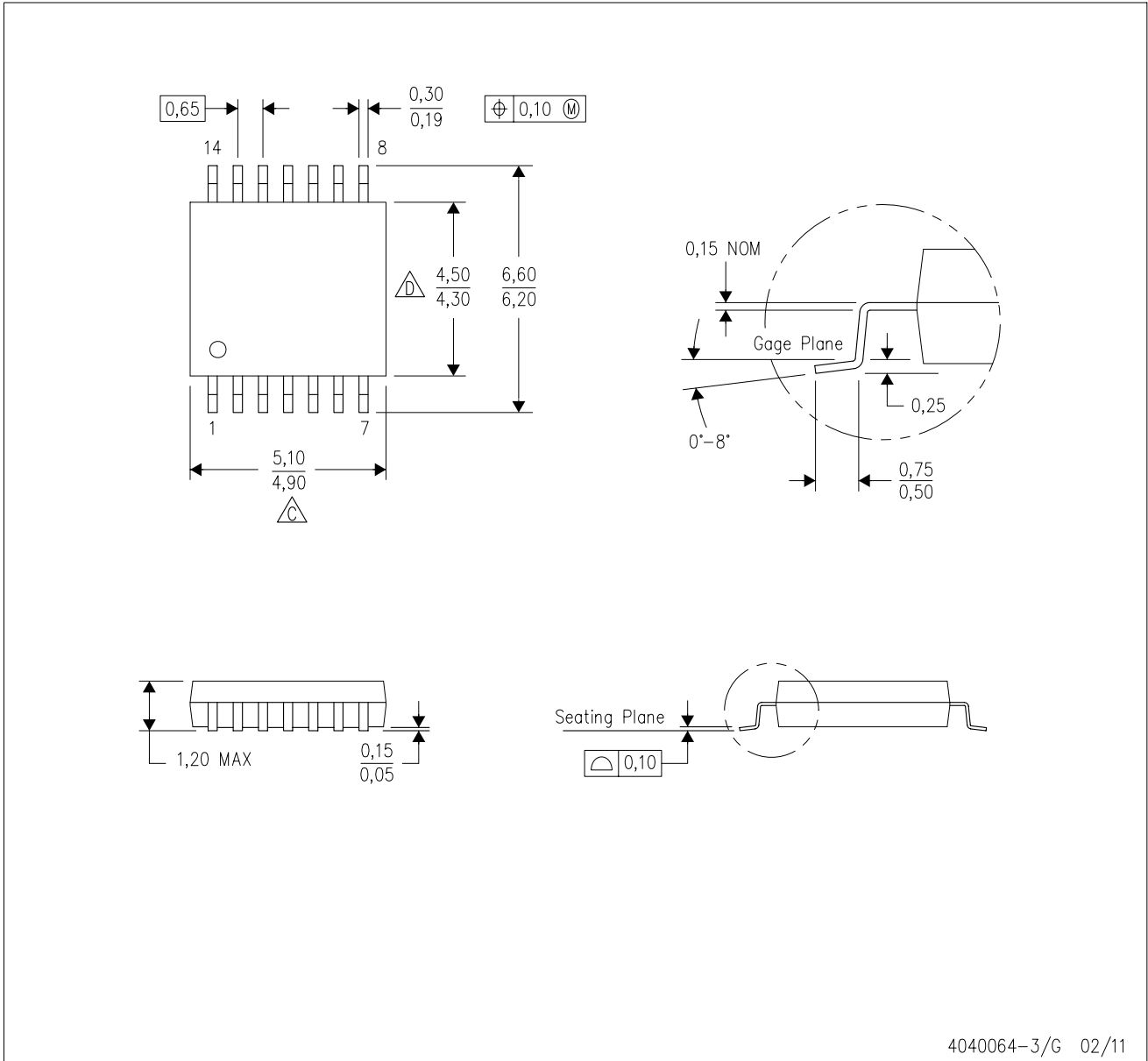

4040064-3/G 02/11

- NOTES:
- A. All linear dimensions are in millimeters. Dimensioning and tolerancing per ASME Y14.5M-1994.
  - B. This drawing is subject to change without notice.
  - C. Body length does not include mold flash, protrusions, or gate burrs. Mold flash, protrusions, or gate burrs shall not exceed 0,15 each side.
  - D. Body width does not include interlead flash. Interlead flash shall not exceed 0,25 each side.
  - E. Falls within JEDEC MO-153

# D0008A



## PACKAGE OUTLINE

SOIC - 1.75 mm max height

SMALL OUTLINE INTEGRATED CIRCUIT



4214825/C 02/2019

### NOTES:

1. Linear dimensions are in inches [millimeters]. Dimensions in parenthesis are for reference only. Controlling dimensions are in inches. Dimensioning and tolerancing per ASME Y14.5M.
2. This drawing is subject to change without notice.
3. This dimension does not include mold flash, protrusions, or gate burrs. Mold flash, protrusions, or gate burrs shall not exceed .006 [0.15] per side.
4. This dimension does not include interlead flash.
5. Reference JEDEC registration MS-012, variation AA.

# EXAMPLE BOARD LAYOUT

D0008A

SOIC - 1.75 mm max height

SMALL OUTLINE INTEGRATED CIRCUIT



LAND PATTERN EXAMPLE  
EXPOSED METAL SHOWN  
SCALE:8X



SOLDER MASK DETAILS

4214825/C 02/2019

NOTES: (continued)

- 6. Publication IPC-7351 may have alternate designs.
- 7. Solder mask tolerances between and around signal pads can vary based on board fabrication site.

# EXAMPLE STENCIL DESIGN

D0008A

SOIC - 1.75 mm max height

SMALL OUTLINE INTEGRATED CIRCUIT



SOLDER PASTE EXAMPLE  
BASED ON .005 INCH [0.125 MM] THICK STENCIL  
SCALE:8X

4214825/C 02/2019

NOTES: (continued)

8. Laser cutting apertures with trapezoidal walls and rounded corners may offer better paste release. IPC-7525 may have alternate design recommendations.
9. Board assembly site may have different recommendations for stencil design.

JG (R-GDIP-T8)

CERAMIC DUAL-IN-LINE

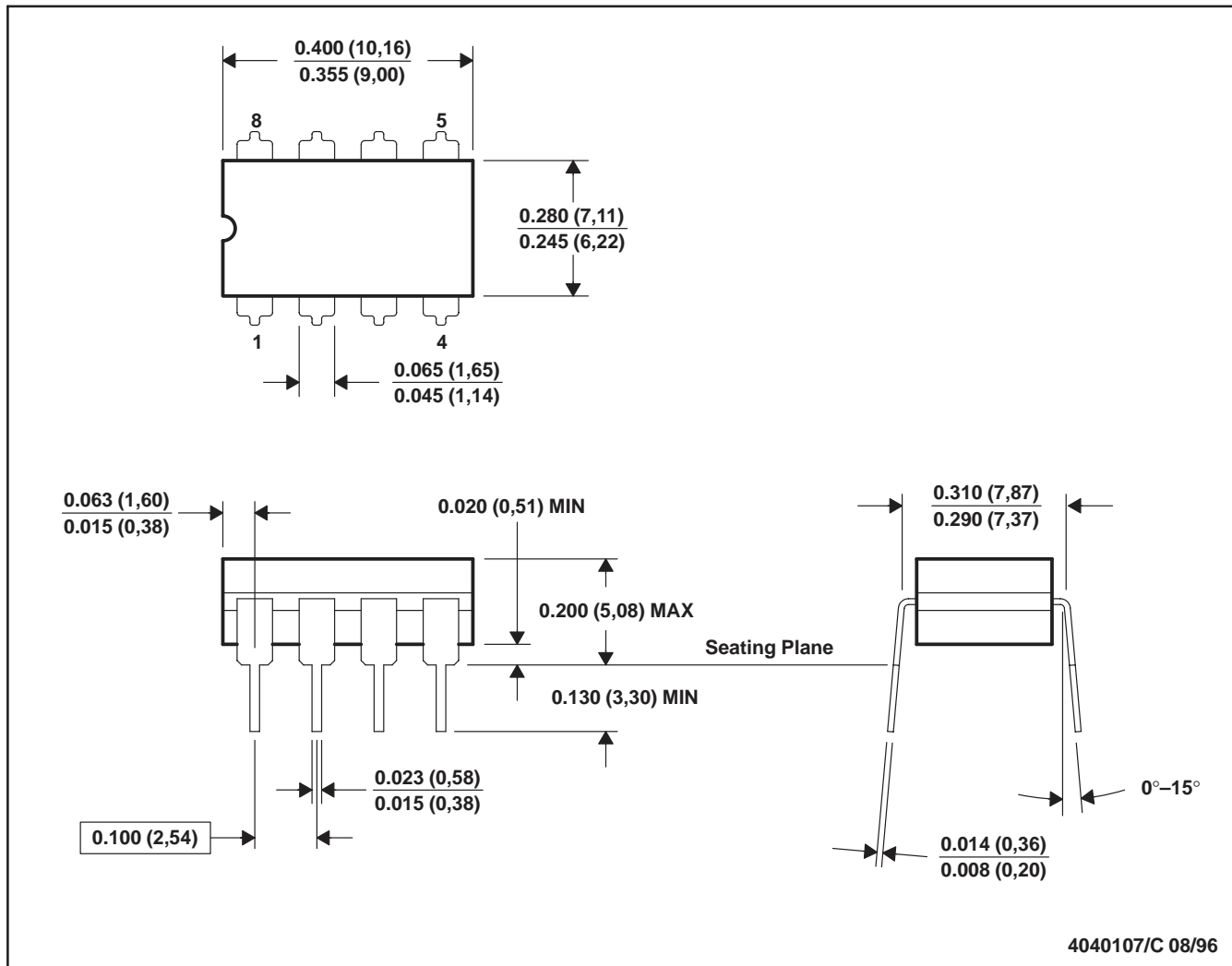

- NOTES: A. All linear dimensions are in inches (millimeters).  
 B. This drawing is subject to change without notice.  
 C. This package can be hermetically sealed with a ceramic lid using glass frit.  
 D. Index point is provided on cap for terminal identification.  
 E. Falls within MIL STD 1835 GDIP1-T8



P (R-PDIP-T8)

PLASTIC DUAL-IN-LINE PACKAGE

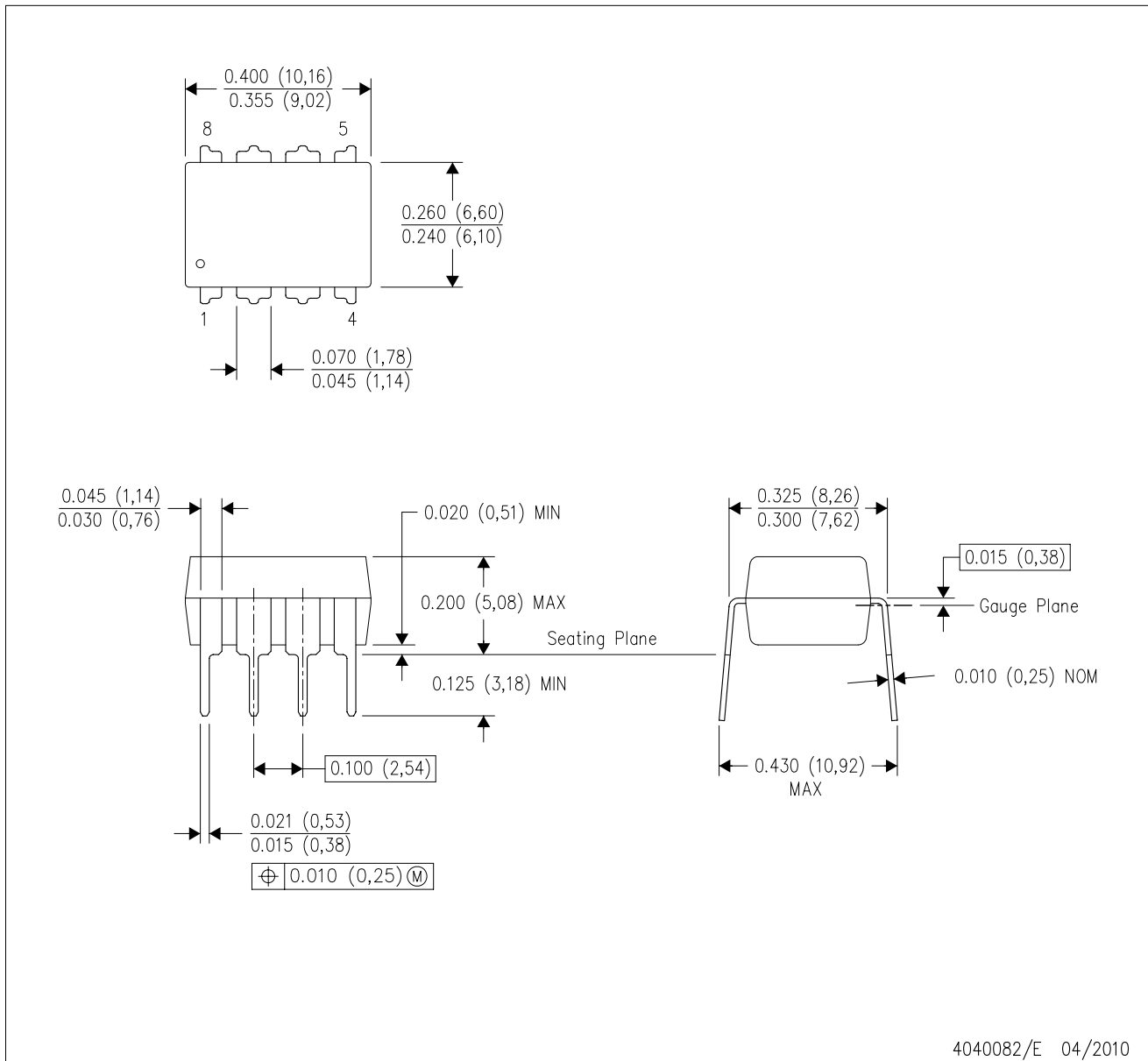

- NOTES:
- A. All linear dimensions are in inches (millimeters).
  - B. This drawing is subject to change without notice.
  - C. Falls within JEDEC MS-001 variation BA.

N (R-PDIP-T\*\*)

PLASTIC DUAL-IN-LINE PACKAGE

16 PINS SHOWN



- NOTES:
- A. All linear dimensions are in inches (millimeters).
  - B. This drawing is subject to change without notice.
  - Falls within JEDEC MS-001, except 18 and 20 pin minimum body length (Dim A).
  - The 20 pin end lead shoulder width is a vendor option, either half or full width.

# DBV0006A



# PACKAGE OUTLINE

SOT-23 - 1.45 mm max height

SMALL OUTLINE TRANSISTOR

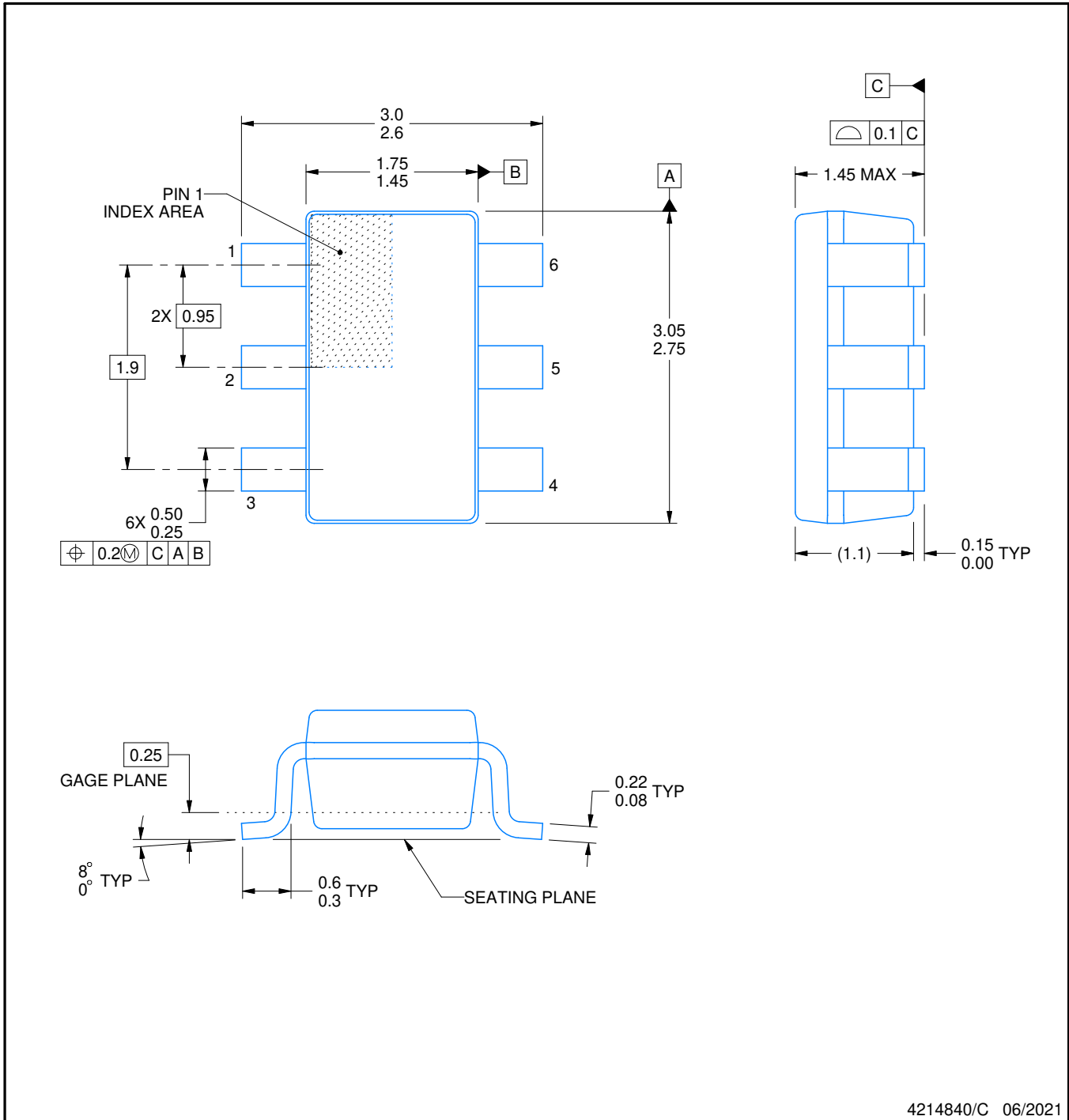

4214840/C 06/2021

**NOTES:**

1. All linear dimensions are in millimeters. Any dimensions in parenthesis are for reference only. Dimensioning and tolerancing per ASME Y14.5M.
2. This drawing is subject to change without notice.
3. Body dimensions do not include mold flash or protrusion. Mold flash and protrusion shall not exceed 0.25 per side.
4. Leads 1,2,3 may be wider than leads 4,5,6 for package orientation.
5. Reference JEDEC MO-178.

# EXAMPLE BOARD LAYOUT

DBV0006A

SOT-23 - 1.45 mm max height

SMALL OUTLINE TRANSISTOR

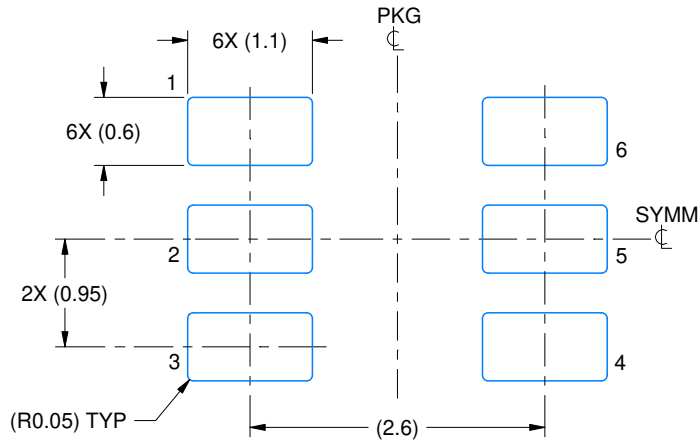

LAND PATTERN EXAMPLE  
EXPOSED METAL SHOWN  
SCALE:15X

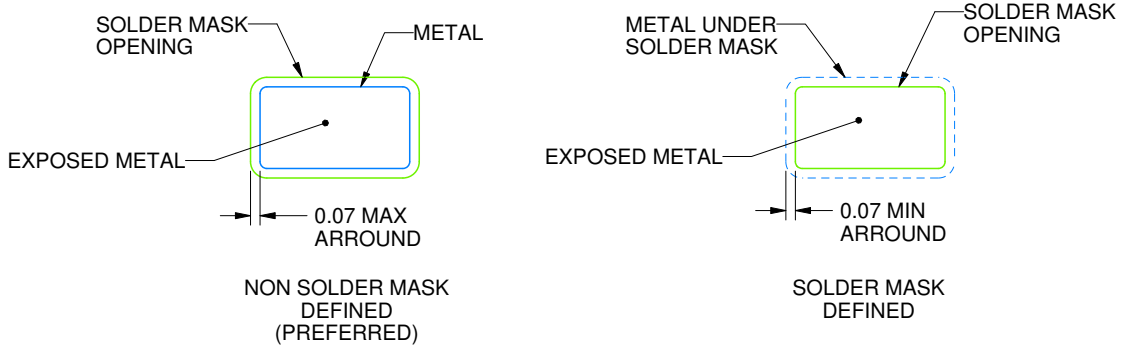

SOLDER MASK DETAILS

4214840/C 06/2021

NOTES: (continued)

- 6. Publication IPC-7351 may have alternate designs.
- 7. Solder mask tolerances between and around signal pads can vary based on board fabrication site.

# EXAMPLE STENCIL DESIGN

DBV0006A

SOT-23 - 1.45 mm max height

SMALL OUTLINE TRANSISTOR

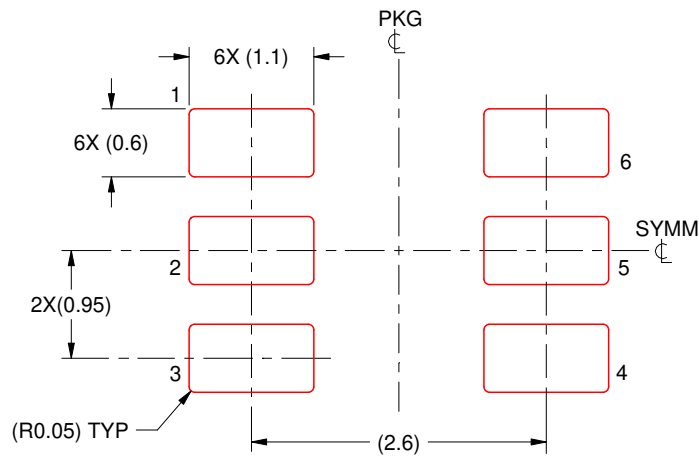

SOLDER PASTE EXAMPLE  
BASED ON 0.125 mm THICK STENCIL  
SCALE:15X

4214840/C 06/2021

NOTES: (continued)

8. Laser cutting apertures with trapezoidal walls and rounded corners may offer better paste release. IPC-7525 may have alternate design recommendations.
9. Board assembly site may have different recommendations for stencil design.

DGK (S-PDSO-G8)

PLASTIC SMALL-OUTLINE PACKAGE

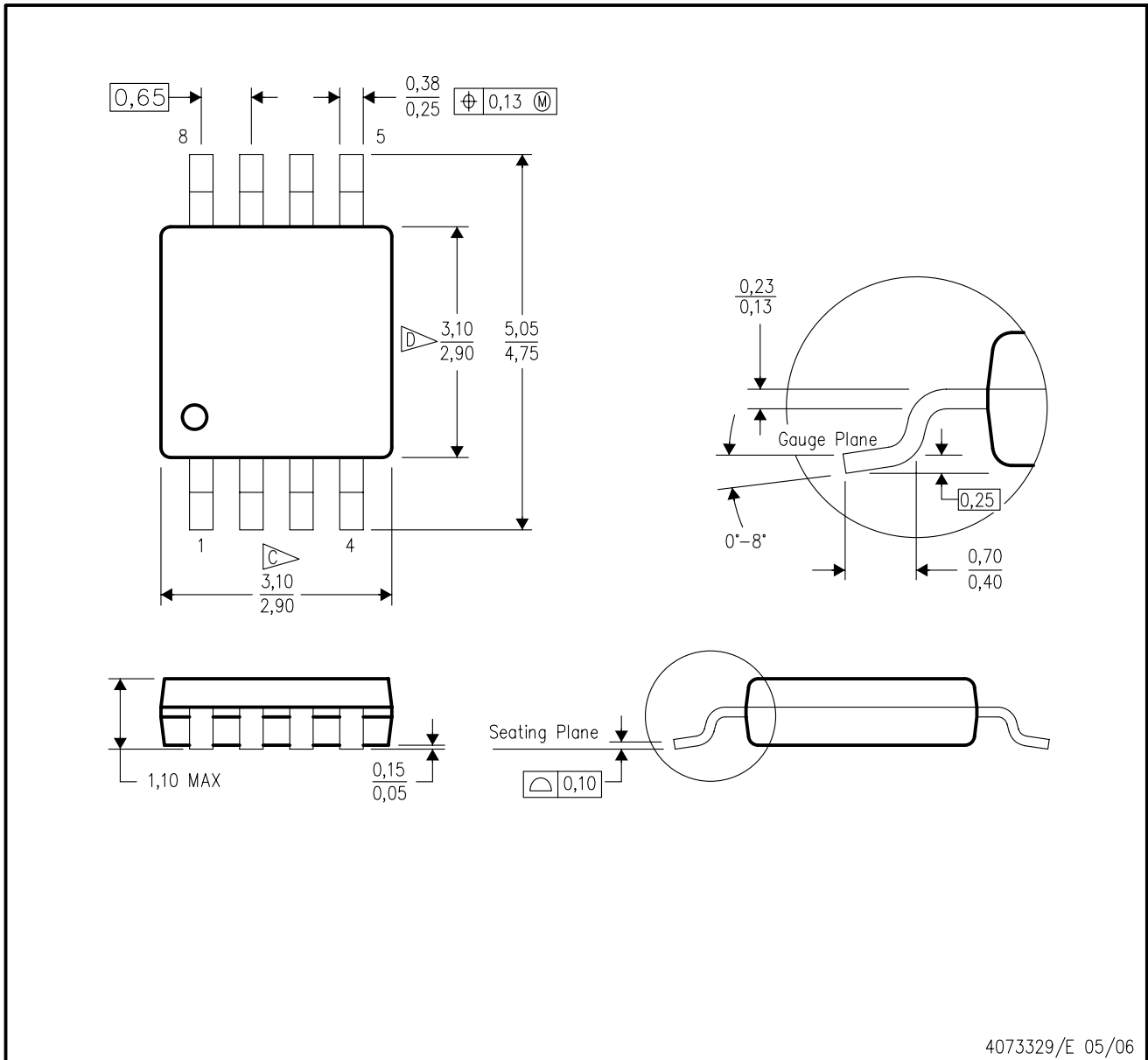

- NOTES:
- A. All linear dimensions are in millimeters.
  - B. This drawing is subject to change without notice.
  - C. Body length does not include mold flash, protrusions, or gate burrs. Mold flash, protrusions, or gate burrs shall not exceed 0.15 per end.
  - D. Body width does not include interlead flash. Interlead flash shall not exceed 0.50 per side.
  - E. Falls within JEDEC MO-187 variation AA, except interlead flash.



- NOTES:
- A. All linear dimensions are in millimeters.
  - B. This drawing is subject to change without notice.
  - C. Publication IPC-7351 is recommended for alternate designs.
  - D. Laser cutting apertures with trapezoidal walls and also rounding corners will offer better paste release. Customers should contact their board assembly site for stencil design recommendations. Refer to IPC-7525 for other stencil recommendations.
  - E. Customers should contact their board fabrication site for solder mask tolerances between and around signal pads.

PW0008A



PACKAGE OUTLINE  
TSSOP - 1.2 mm max height

SMALL OUTLINE PACKAGE

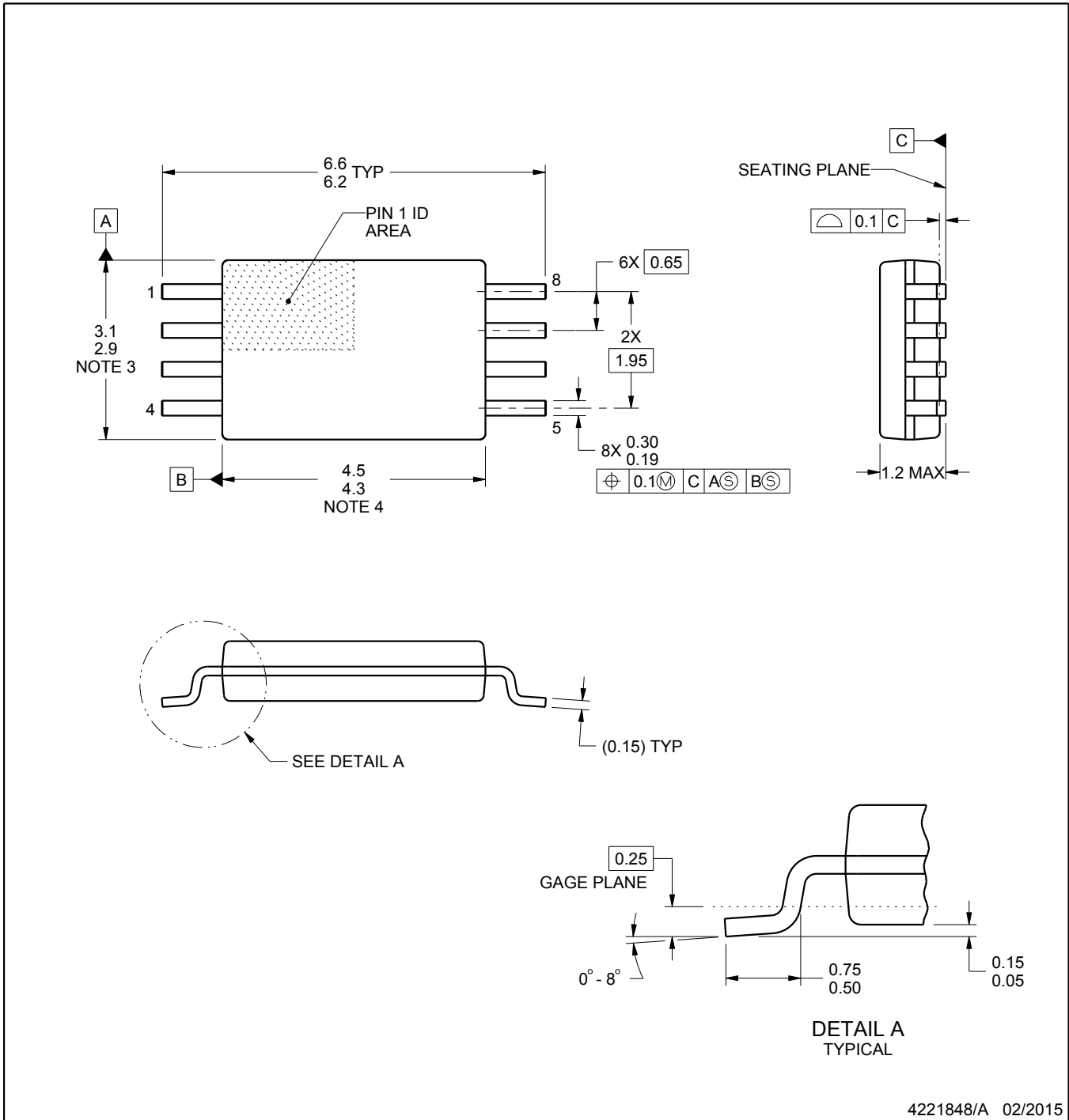

4221848/A 02/2015

NOTES:

1. All linear dimensions are in millimeters. Any dimensions in parenthesis are for reference only. Dimensioning and tolerancing per ASME Y14.5M.
2. This drawing is subject to change without notice.
3. This dimension does not include mold flash, protrusions, or gate burrs. Mold flash, protrusions, or gate burrs shall not exceed 0.15 mm per side.
4. This dimension does not include interlead flash. Interlead flash shall not exceed 0.25 mm per side.
5. Reference JEDEC registration MO-153, variation AA.



# EXAMPLE BOARD LAYOUT

PW0008A

TSSOP - 1.2 mm max height

SMALL OUTLINE PACKAGE

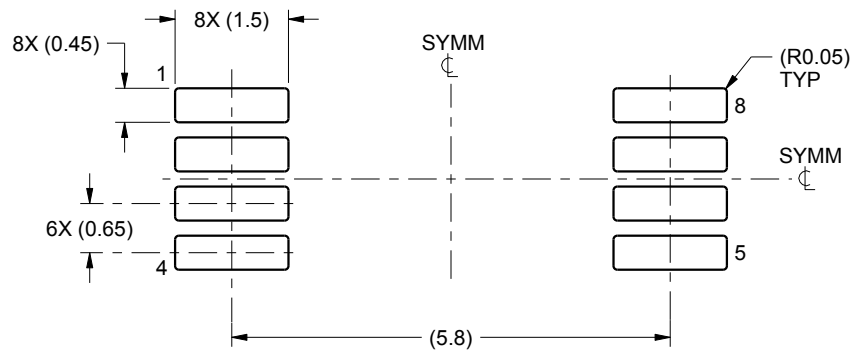

LAND PATTERN EXAMPLE  
SCALE:10X

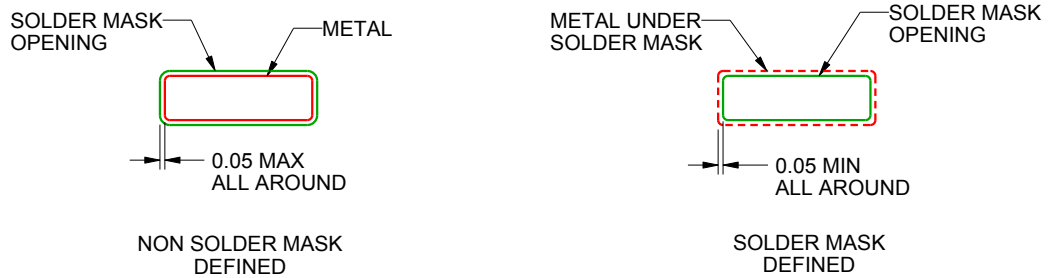

SOLDER MASK DETAILS  
NOT TO SCALE

4221848/A 02/2015

NOTES: (continued)

- 6. Publication IPC-7351 may have alternate designs.
- 7. Solder mask tolerances between and around signal pads can vary based on board fabrication site.

# EXAMPLE STENCIL DESIGN

PW0008A

TSSOP - 1.2 mm max height

SMALL OUTLINE PACKAGE

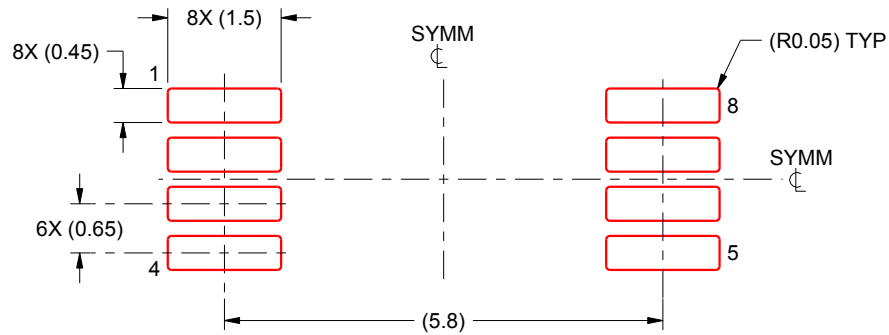

SOLDER PASTE EXAMPLE  
BASED ON 0.125 mm THICK STENCIL  
SCALE:10X

4221848/A 02/2015

NOTES: (continued)

8. Laser cutting apertures with trapezoidal walls and rounded corners may offer better paste release. IPC-7525 may have alternate design recommendations.
9. Board assembly site may have different recommendations for stencil design.

U0010A



# PACKAGE OUTLINE

CFP - 2.03 mm max height

CERAMIC FLATPACK

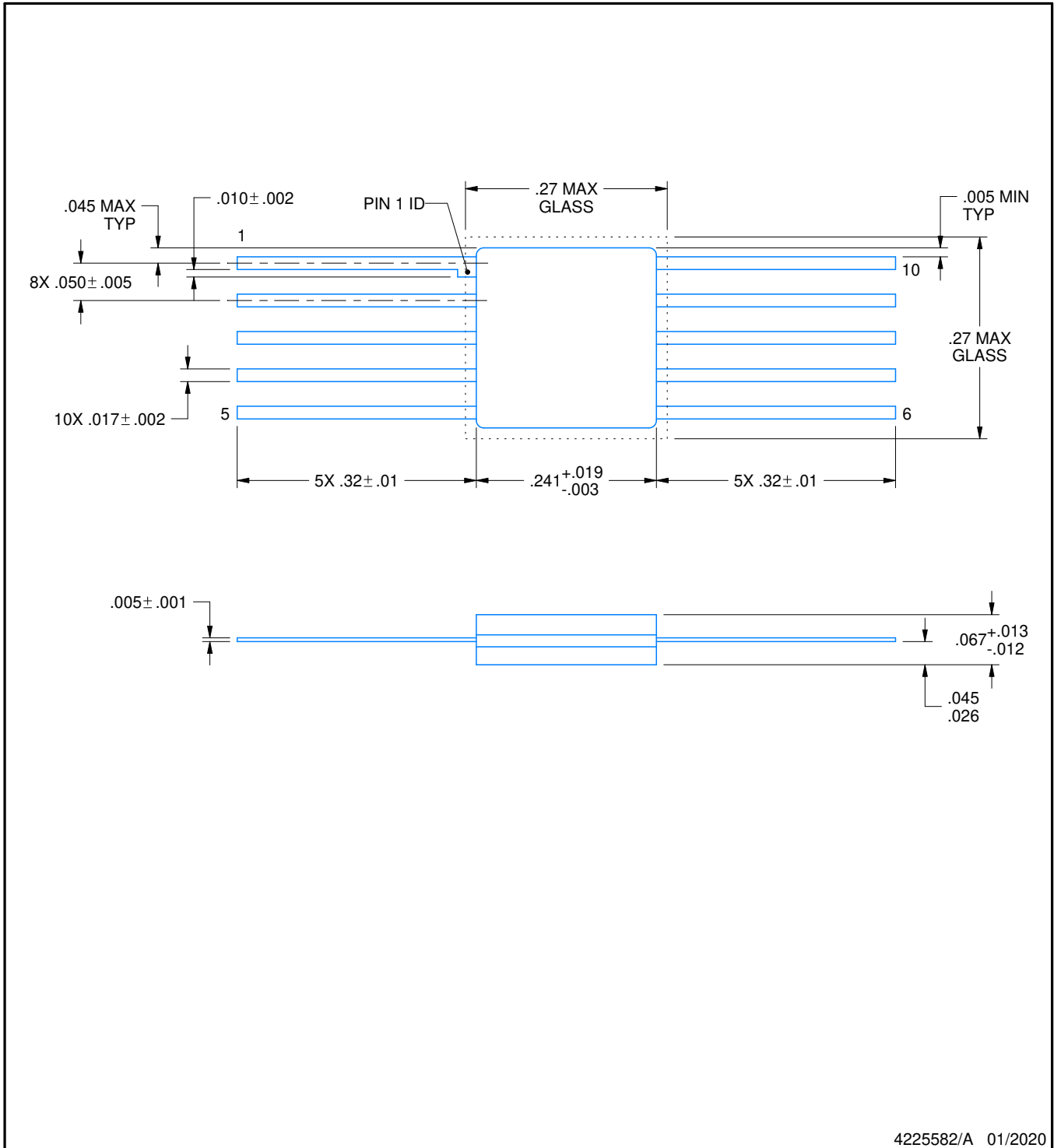

4225582/A 01/2020

NOTES:

1. All linear dimensions are in inches. Any dimensions in parenthesis are for reference only. Dimensioning and tolerancing per ASME Y14.5M.
2. This drawing is subject to change without notice.

## IMPORTANT NOTICE AND DISCLAIMER

TI PROVIDES TECHNICAL AND RELIABILITY DATA (INCLUDING DATA SHEETS), DESIGN RESOURCES (INCLUDING REFERENCE DESIGNS), APPLICATION OR OTHER DESIGN ADVICE, WEB TOOLS, SAFETY INFORMATION, AND OTHER RESOURCES "AS IS" AND WITH ALL FAULTS, AND DISCLAIMS ALL WARRANTIES, EXPRESS AND IMPLIED, INCLUDING WITHOUT LIMITATION ANY IMPLIED WARRANTIES OF MERCHANTABILITY, FITNESS FOR A PARTICULAR PURPOSE OR NON-INFRINGEMENT OF THIRD PARTY INTELLECTUAL PROPERTY RIGHTS.

These resources are intended for skilled developers designing with TI products. You are solely responsible for (1) selecting the appropriate TI products for your application, (2) designing, validating and testing your application, and (3) ensuring your application meets applicable standards, and any other safety, security, regulatory or other requirements.

These resources are subject to change without notice. TI grants you permission to use these resources only for development of an application that uses the TI products described in the resource. Other reproduction and display of these resources is prohibited. No license is granted to any other TI intellectual property right or to any third party intellectual property right. TI disclaims responsibility for, and you will fully indemnify TI and its representatives against, any claims, damages, costs, losses, and liabilities arising out of your use of these resources.

TI's products are provided subject to [TI's Terms of Sale](#) or other applicable terms available either on [ti.com](https://www.ti.com) or provided in conjunction with such TI products. TI's provision of these resources does not expand or otherwise alter TI's applicable warranties or warranty disclaimers for TI products.

TI objects to and rejects any additional or different terms you may have proposed.

Mailing Address: Texas Instruments, Post Office Box 655303, Dallas, Texas 75265  
Copyright © 2023, Texas Instruments Incorporated