

GL-2030FV

Aliases (UNFGL2030FVXXX)

Obsolete

KEMET, GL-FV, EMI/RFI Filters, Noise Suppression, 250 VAC, 250 V, 3 A

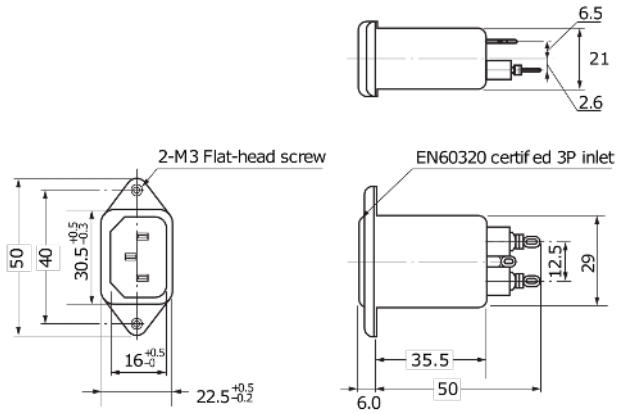

Click [here](#) for the 3D model.

Dimensions

L	50mm NOM
W	50mm NOM
H	22.5mm NOM

Packaging Specifications

Component Weight	40 g
------------------	------

General Information

Series	GL-FV
Style	Inlet
Description	Noise Filters
Features	Inlet Type
RoHS	Yes
Qualifications	UL, CSA, TUV, VDE
Miscellaneous	30 K Self-Temperature Rise Max.

Specifications

Voltage AC	250 VAC
Voltage DC	250 VDC
Voltage	250 VDC, 1500 VAC Withstanding Voltage 1 Min. Line to Ground
Rated Current	3 A (AC/DC)
Ripple Current	3 A (AC/DC)
Temperature Range	-25/+55°C
Leakage Current	0.5 mA MAX (250 V 60 Hz)
Resistance	300 MOhms MIN Insulation 500 VDC 1 Min. Line To Ground