

Commercial Grade Adapters

Features

- Best combination of price and performance
- For general commercial use
- Up to 18 GHz operation
- Gold and nickelplated brass construction
- SMA to SMA, SMA to N, SMA to MCX, male/female versions
- Bulkhead SMA female to SMA female also available



Applications

- Cellular base stations
- Public safety systems
- Wi-Fi networks hardware
- Active antenna systems
- 5G network hardware
- GPS systems

Electrical

	SMA to SMA Models	SMA to N Models	SMA to MCX Models
Frequency of Operation	DC-18 GHz	DC-10 GHz	DC-6 GHz
Impedance	50Ω (Nominal)	50Ω (Nominal)	50Ω (Nominal)
VSWR	1.2:1 (max.)	1.2:1 (max.)	1.2:1 (max.)

Materials and Finish

Body	Gold plated brass	Nickel plated brass	Gold plated brass
Male Center Contact	Gold plated brass	Gold plated brass	Gold plated brass
Female Center Contact	Gold plated beryllium copper	Gold plated beryllium copper	Gold plated beryllium copper
Insulator	PTFE	PTFE	PTFE

Environmental

Operating Temperature	-40°C to +85°C	-40°C to +85°C	-40°C to +85°C
-----------------------	----------------	----------------	----------------

Commercial Grade Adapters



SMA Male to MCX Female

Part Number	Material	Impedance	Maximum Frequency	VSWR
CGM-1060-SM-MCF-09	Gold Plated	50 Ohms	DC - 6 GHz	1.20 Max

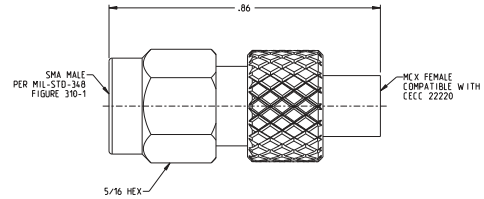

SMA Male to MCX Male

Part Number	Material	Impedance	Maximum Frequency	VSWR
CGM-1060-SM-MCM-09	Gold Plated	50 Ohms	DC - 6 GHz	1.20 Max

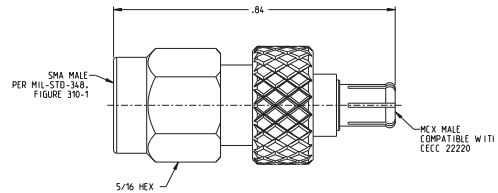

SMA Female to MCX Female

Part Number	Material	Impedance	Maximum Frequency	VSWR
CGM-1060-SF-MCF-09	Gold Plated	50 Ohms	DC - 6 GHz	1.20 Max

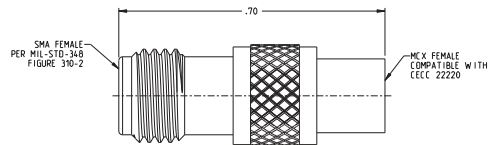

Commercial Grade Adapters



SMA Female to MCX Male

Part Number	Material	Impedance	Maximum Frequency	VSWR
CGM-1060-SF-MCM-09	Gold Plated	50 Ohms	DC - 6 GHz	1.20 Max

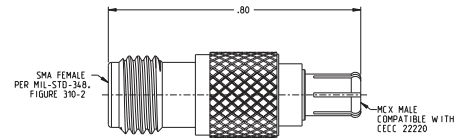

SMA Male to N Female Adapter

Part Number	Material	Impedance	Maximum Frequency	VSWR
CGM-1100-NF-SMM-10	Gold Plated	50 Ohms	DC - 10 GHz	1.20 Max

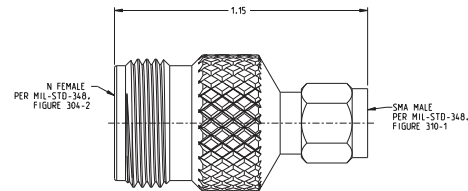

SMA Male to N Male Adapter

Part Number	Material	Impedance	Maximum Frequency	VSWR
CGM-1100-NM-SMM-10	Gold Plated	50 Ohms	DC - 10 GHz	1.20 Max

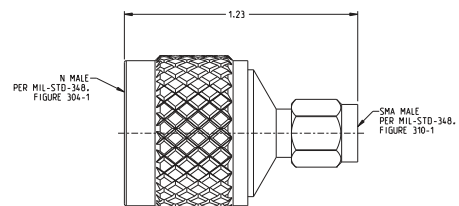

SMA Female to N Female Adapter

Part Number	Material	Impedance	Maximum Frequency	VSWR
CGM-1100-NF-SMF-10	Gold Plated	50 Ohms	DC - 10 GHz	1.20 Max

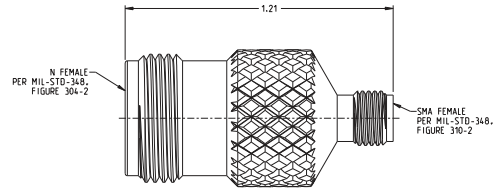

SMA Female to N Male Adapter

Part Number	Material	Impedance	Maximum Frequency	VSWR
CGM-1100-NM-SMF-10	Gold Plated	50 Ohms	DC - 10 GHz	1.20 Max

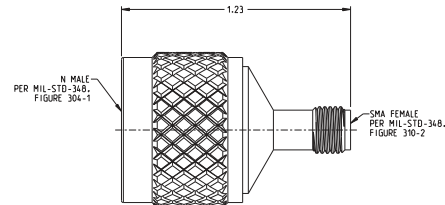

SMA Male to SMA Female

Part Number	Material	Impedance	Maximum Frequency	VSWR
CGM-1180-MF-SMA-09	Gold Plated	50 Ohms	DC - 18 GHz	1.20 Max

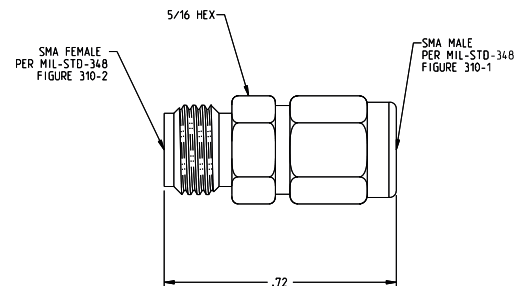

Commercial Grade Adapters



SMA Male to SMA Male

Part Number	Material	Impedance	Maximum Frequency	VSWR
CGM-1180-MM-SMA-09	Gold Plated	50 Ohms	DC - 18 GHz	1.20 Max

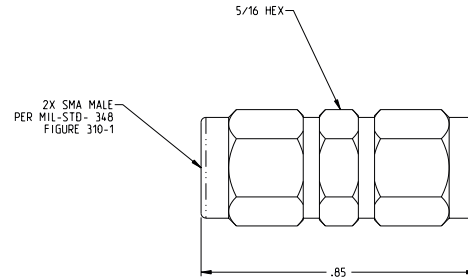

SMA Female to SMA Female

Part Number	Material	Impedance	Maximum Frequency	VSWR
CGM-1180-FF-SMA-09	Gold Plated	50 Ohms	DC - 18 GHz	1.20 Max

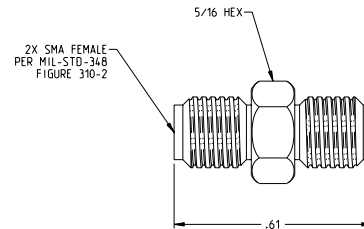

SMA Female to SMA Female Bulkhead

Part Number	Material	Impedance	Maximum Frequency	VSWR
CGM-1180-FB-SMA-09	Gold Plated	50 Ohms	DC - 18 GHz	1.20 Max

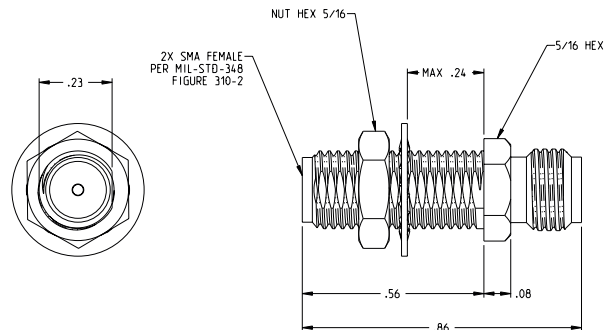

Asia Pacific
+86 21 5442 7668
ccs.asia.sales@as.cinch.com

Europe, Middle East & Africa
+44 (0) 1245 342060
cinchconnectivity@eu.cinch.com

North America
+1 507 833 8822
ccsorders@us.cinch.com

belfuse.com/cinch