

THIS IS A C.A.D. GENERATED DRAWING  
DO NOT MAKE MANUAL REVISIONS TO MASTER.

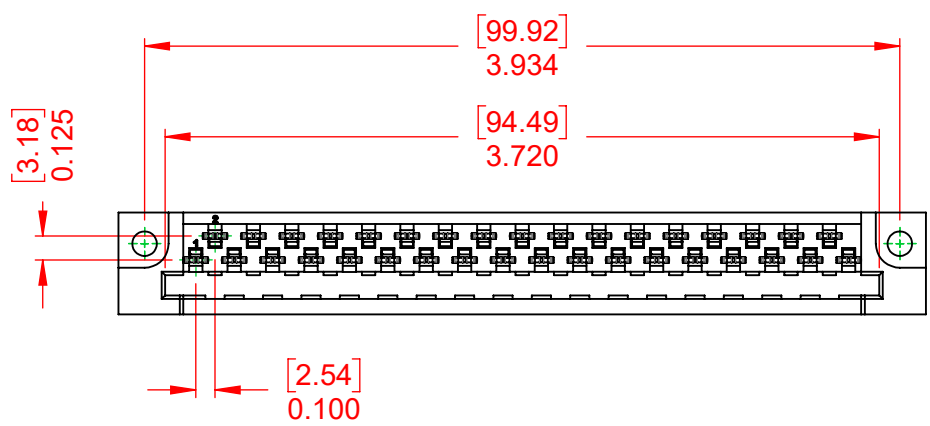

ISSUE NUMBER	
ORIGINAL	①

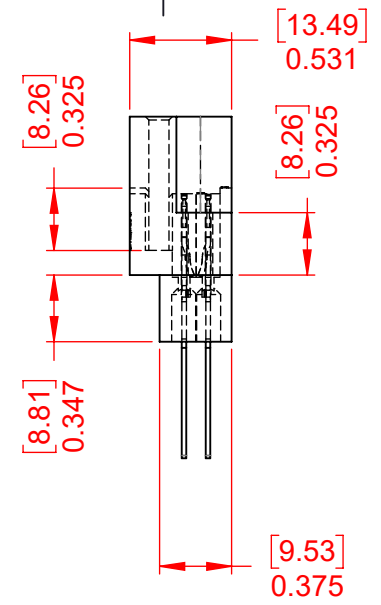
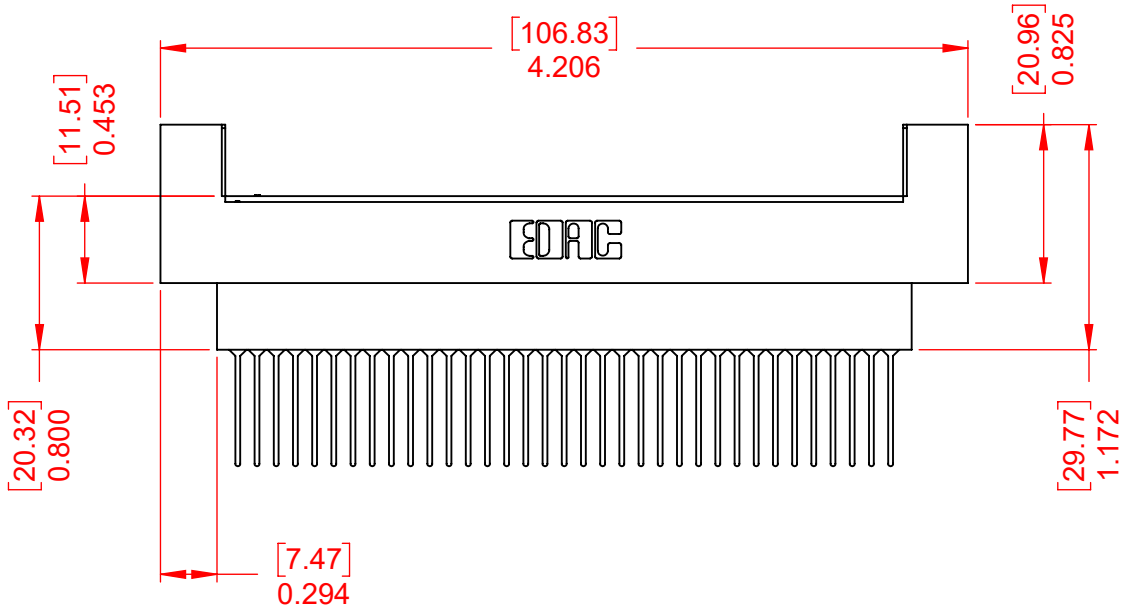

NOTES:

- MATERIAL:  
 HOUSING: DIALLYL PTHYHALATE, UL94V-0  
 CONTACT MATERIAL: COPPER ALLOY  
 CONTACT PLATING: GOLD PLATING OVER NICKEL  
 INSERTION FORCE: 6 TO 16 Oz (0.56 TO 4.45N) PER CONTACT  
 WITHDRAWAL FORCE: 6 TO 16 Oz (0.56 TO 4.45N) PER CONTACT

OPERATING TEMPERATURE: -65°C ~ 125°C

- CURRENT RATING: 10A PER CONTACT  
 CONTACT RESISTANCE: 10mΩ MAX.  
 INSULATOR RESISTANCE: 5000MΩ min.  
 DIELECTRIC  
 WITHSTANDING VOLTAGE: 2000V AC rms AT SEA LEVEL

CONTACT TYPE:  
 541-Wire Wrap .026x.024(0.66x0.61) - Tail LG.=.620(15.75)



THIS SERIES FULLY CONFORMS TO  
THE EUROPEAN UNION DIRECTIVES  
2011/65/EU FOR RoHS COMPLIANCY.

**EDAC** EDAC INC  
TORONTO, ONTARIO  
CANADA  
YOUR CONNECTION TO QUALITY & SERVICE

THESE DRAWINGS AND SPECIFICATIONS  
ARE THE PROPERTY OF EDAC INC., AND  
SHALL NOT BE REPRODUCED, OR COPIED  
OR USED AS THE BASIS FOR THE  
MANUFACTURE OR SALE OF APPARATUS  
WITHOUT WRITTEN PERMISSION.

415 & 438 SERIES CARD EDGE		SW REFERENCE NO.: 415 ASSEMBLY	
		DRAWN: W.T	DATE: AUG. 01/2018
		CHECKED:	DATE:
		SCALE: 1:1	SHEET 1 OF 1
DRAWING NUMBER: 415-035-541-222			ISSUE
PART NUMBER: 415-035-541-222			1