

MAX15501 Evaluation Kit

Evaluates: MAX15500/MAX15501

General Description

The MAX15501 evaluation kit (EV kit) provides a proven design to evaluate the MAX15501 analog output conditioner that provides a programmable current up to $\pm 24\text{mA}$, or a voltage up to $\pm 12\text{V}$ proportional to a control voltage signal. The EV kit also includes Windows® 2000-, Windows XP®, and Windows Vista®-compatible software that provides a simple graphical user interface (GUI) for exercising the features of the MAX15501.

The MAX15501 EV kit comes with a MAX15501GTJ+ installed. Contact the factory for free samples of the pin-compatible MAX15500GTJ+ to evaluate this device.

Features

- ◆ On-Board 16-Bit DAC
- ◆ On-Board +2.5V (for MAX15501) and +4.096V (for MAX15500) Voltage References
- ◆ Four Jumper-Selectable On-Board Sensing Resistors (41.2 Ω , 42.2 Ω , 47.5 Ω , and 48.7 Ω)
- ◆ Terminal Block Connector for the OUT, GND, SENSEVP, and SENSEVN Signals
- ◆ Windows 2000-, Windows XP-, and Windows Vista (32-Bit)-Compatible Software
- ◆ USB-PC Connection (Cable Included)
- ◆ Proven PCB Layout
- ◆ Fully Assembled and Tested

Ordering Information

PART	TYPE
MAX15501EVKIT+	EV Kit

+Denotes lead(Pb)-free and RoHS compliant.

Component List

DESIGNATION	QTY	DESCRIPTION
C1, C12, C14	3	10 μF $\pm 20\%$, 16V X5R ceramic capacitors (1206) Murata GRM31CR61C106M
C2, C3	2	22pF $\pm 5\%$, 50V C0G ceramic capacitors (0603) Murata GRM1885C1H220J
C4	1	0.033 μF $\pm 10\%$, 16V X5R ceramic capacitor (0603) Taiyo Yuden EMK107BJ333KA
C5–C10, C17, C18, C24–C29, C31, C32, C33, C35, C38, C49, C50	21	0.1 μF $\pm 10\%$, 16V X7R ceramic capacitors (0603) Murata GRM188R71C104K
C11, C13, C19–C23, C36, C39–C46	16	1 μF $\pm 10\%$, 16V X5R ceramic capacitors (0603) Murata GRM188R71C105K
C15, C16	2	10pF $\pm 5\%$, 50V C0G ceramic capacitors (0603) Murata GRM1885C1H100J

Windows, Windows XP, and Windows Vista are registered trademarks of Microsoft Corp.

DESIGNATION	QTY	DESCRIPTION
C30	1	4.7 μF $\pm 10\%$, 16V X5R ceramic capacitor (0805) Murata GRM21BR61C475K
C34, C37	2	0.1 μF $\pm 10\%$, 25V X7R ceramic capacitors (0603) Murata GRM188R71E104K
C47, C48	2	10 μF $\pm 20\%$, 25V X5R ceramic capacitors (1206) Murata GRM31CR61E106K
CC	0	Not installed, capacitor (0603)
D1–D6	6	Diodes (SOT23) Central Semi CMPD7000
J1	1	USB type-B right-angle female receptacle
J2	1	20-pin header (2 x 10)
J3	1	4-position terminal block
JU1, JU2, JU3, JU6–JU10, JU12–JU16, JU19, JU20, JU25, JU26, JU35	18	3-pin headers

For pricing, delivery, and ordering information, please contact Maxim Direct at 1-888-629-4642, or visit Maxim's website at www.maximintegrated.com.

MAX15501 Evaluation Kit

Evaluates: MAX15500/MAX15501

Component List (continued)

DESIGNATION	QTY	DESCRIPTION
JU4, JU5	2	4-pin headers
JU18	1	5-pin header
JU22, JU23, JU24, JU27–JU34	11	2-pin headers
L1	1	Ferrite bead TDK MMZ1608R301A (0603)
R1, R2	2	27 Ω \pm 5% resistors (0603)
R3	1	1.5k Ω \pm 5% resistor (0603)
R4	1	470 Ω \pm 5% resistor (0603)
R5	1	2.2k Ω \pm 5% resistor (0603)
R6, R7	2	10k Ω \pm 5% resistors (0603)
R8	1	5.1 Ω \pm 5% resistor (0805)
R10	1	169k Ω \pm 1% resistor (0603)
R11	1	100k Ω \pm 1% resistor (0603)
R12–R16	0	Not installed, resistor—short (PC trace) (0603)
RS1	1	48.7 Ω \pm 0.1% sense resistor
RS2	1	47.5 Ω \pm 0.1% sense resistor
RS3	1	42.2 Ω \pm 0.1% sense resistor
RS4	1	41.2 Ω \pm 0.1% sense resistor
U1	1	Analog output conditioner (32 TQFN-EP*) Maxim MAX15501GTJ+
U2	1	Adjustable output LDO regulator (5 SC70) Maxim MAX8512EXK+T
U3	1	LDO regulator (5 SC70) Maxim MAX8511EXK25+T
U4	1	USB-to-UART converter (32 TQFP)

DESIGNATION	QTY	DESCRIPTION
U5	1	93C46 type 3-wire EEPROM 16-bit architecture (8 SO)
U6	1	Microcontroller (68 QFN-EP*) Maxim MAXQ2000-RAX+
U7	1	4.096V voltage reference (8 SO) Maxim MAX6126AASA41+
U8	1	16-bit DAC (16 TQFN) Maxim MAX5138BGTE+
U9–U14	6	Level translator (10 μ MAX®) Maxim MAX1840EUB+
U15	1	5V LDO (6 TDFN) Maxim MAX5084ATT+
U16	1	2.5V voltage reference (8 SO) Maxim MAX6126AASA25+
Y1	1	16MHz crystal Hong Kong X'tals SSM16000N1HK188F0-0
Y2	1	6MHz crystal Hong Kong X'tals SSL60000N1HK188F0-0
Y3	0	Not installed, crystal
—	32	Shunts
—	1	PCB: MAX15501 EVALUATION KIT+

*EP = Exposed pad.

Component Suppliers

SUPPLIER	PHONE	WEBSITE
Central Semiconductor Corp.	631-435-1110	www.centralsemi.com
Hong Kong X'tals Ltd.	852-35112388	www.hongkongcrystal.com
Murata Electronics North America, Inc.	770-436-1300	www.murata-northamerica.com
Taiyo Yuden	800-348-2496	www.t-yuden.com
TDK Corp.	847-803-6100	www.component.tdk.com

Note: Indicate that you are using the MAX15501 when contacting these component suppliers.

μ MAX is a registered trademark of Maxim Integrated Products, Inc.

MAX15501 Evaluation Kit

Evaluates: MAX15500/MAX15501

Quick Start

Required Equipment

- MAX15501 EV kit (USB cable included)
- $\pm 25\text{V}/100\text{mA}$ DC power supply
- User-supplied Windows 2000, Windows XP, or Windows Vista PC with a spare USB port
- One digital voltmeter
- One digital current meter

Note: In the following sections, software-related items are identified by bolding. Text in **bold** refers to items directly from the EV kit software. Text in **bold and underlined** refers to items from the Windows operating system.

Procedure

The MAX15501 EV kit is fully assembled and tested. Follow the steps below to verify board operation.

Caution: Do not turn on the power supply until all connections are completed.

- 1) Visit www.maximintegrated.com/evkitsoftware to download the latest version of the EV kit software, 15501Rxx.ZIP. Save the EV kit software to a temporary folder and uncompress the ZIP file.
- 2) Install the EV kit software on your computer by running the INSTALL.EXE program inside the temporary folder. The program files are copied and icons are created in the Windows **Start | Programs** menu.
- 3) Verify that all jumpers are in their default positions, as shown in Table 3.
- 4) Connect the USB cable from the PC to the EV kit board. A **New Hardware Found** window pops up when installing the USB driver for the first time. If a window is not seen that is similar to the one described above after 30s, remove the USB cable from the board and reconnect it. Administrator privileges are required to install the USB device driver on Windows.
- 5) Follow the directions of the **Add New Hardware Wizard** to install the USB device driver. Choose the **Search for the best driver for your device** option. Specify the location of the device driver to be **C:\Program Files\MAX15501** (default installation directory) using the **Browse** button. During device driver installation, Windows may show a warning message indicating that the device driver Maxim uses does not contain a digital signature. This is not an error condition and it is safe to proceed with installation. Refer to the USB_Driver_Help.PDF

document included with the software for additional information.

Voltage Mode

- 6) Connect pin 1 (OUTPUT) to pin 3 (SENSEVP) of the J3 connector with a cable.
- 7) Connect pin 2 (AGND) to pin 4 (SENSEVN) of the J3 connector with a cable.
- 8) Connect the +25V DC supply to the AVDD pad.
- 9) Connect the -25V DC supply to the AVSS pad.
- 10) Connect the ground terminal of the DC supply to the AGND pad.
- 11) Turn on the power supply.
- 12) Start the MAX15501 EV kit software by opening its icon in the **Start | Programs** menu. The EV kit software main window appears, as shown in Figure 1.
- 13) Wait approximately 5s for the program to automatically detect the EV kit.
- 14) Press the **Set** button in the **DAC** group box to set the DAC output to 0V.
- 15) Uncheck the **Disable Analog Output (OUTDIS)** checkbox to enable the MAX15501.
- 16) Select **101: Bipolar Voltage: $\pm 10\text{V}$** in the **Mode** drop-down list.
- 17) Use the voltmeter to verify that the output voltage on pin 1 of J3 is approximately -12V.
- 18) Move the scrollbar in the **DAC** group box all the way to the right and press the **Set** button (DAC full-scale output = +2.5V).
- 19) Use the voltmeter to verify that the output voltage on pin 1 of J3 is approximately +12V.

Current Mode

By default, the on-board 41.2Ω sensing resistor is selected.

- 6) Connect a 750Ω resistor load in series with a current meter between pin 1 (OUTPUT) and pin 2 (AGND) of the J3 connector.
- 7) Connect pin 1 (OUTPUT) to pin 3 (SENSEVP) of the J3 connector with a cable.
- 8) Connect pin 2 (AGND) to pin 4 (SENSEVN) of the J3 connector with a cable.
- 9) Connect the +25V DC supply to the AVDD pad.
- 10) Connect the -25V DC supply to the AVSS pad.
- 11) Connect the ground terminal of the DC supply to the AGND pad.

MAX15501 Evaluation Kit

Evaluates: MAX15500/MAX15501

- 12) Turn on the power supply.
- 13) Start the MAX15501 EV kit software by opening its icon in the **Start | Programs** menu. The EV kit software main window appears, as shown in Figure 1.
- 14) Wait approximately 5s for the program to automatically detect the EV kit.
- 15) Press the **Set** button in the **DAC** group box to set the DAC output to 0V.
- 16) Uncheck the **Disable Analog Output ($\overline{\text{OUTDIS}}$)** checkbox to enable the MAX15501.
- 17) Select **101: Bipolar Voltage: $\pm 10\text{V}$** in the **Mode** drop-down list.
- 18) Use the voltmeter to verify that the output voltage on pin 1 of J3 is approximately -12V.
- 19) Move the scrollbar in the **DAC** group box all the way to the right and press the **Set** button (DAC full scale output = +2.5V).
- 20) Use the voltmeter to verify that the output voltage on pin 1 of J3 is approximately +12V.

Detailed Description of Software

The main window of the evaluation software is shown in Figure 1. The software can be used to control both the on-board 16-bit DAC and the MAX15501.

DAC

In the **DAC** group box, use the scrollbar to set the 16-bit DAC data. The adjacent edit box at the left of the scrollbar displays the equivalent expected output-voltage values of the on-board DAC. The user can also set the output-voltage values of the DAC by typing the desired voltage value in the edit box and pressing the Enter key. Press the **Set** button to update the DAC output.

Configuration

The **Configuration** group box has all the controls for the MAX15501.

To set the operating mode of the MAX15501, select the appropriate mode in the **Mode** drop-down list.

The **Brown out Threshold** drop-down list sets the brownout threshold for error reporting.

When evaluating the MAX15501 on the MAX15501 EV kit, select the **2.5V** option from the **FS Select** drop-down list.

Select the **4.096V** option in the **FS Select** drop-down list when evaluating the MAX15500 on the MAX15501 EV kit.

When the **20% above FS** option is selected in the **FS Mode** drop-down list, the FSMODE pin of the MAX15501 is set to logic-low, which sets the output voltage to 120%FS when the input voltage is equal to the full-scale value. When the **5% above FS** option is selected in the **FS Mode** drop-down list, the FSMODE pin of the MAX15501 is set to logic-high, which sets the output voltage to 105%FS when the input voltage is equal to the full-scale value.

Check the **Thermal Self Protect** checkbox to turn on the thermal protection of the MAX15501.

Uncheck the **Disable Analog Output ($\overline{\text{OUTDIS}}$)** checkbox to set the $\overline{\text{OUTDIS}}$ pin to logic-high and enable the output of the MAX15501. To disable the output of the MAX15501, check the **Disable Analog Output ($\overline{\text{OUTDIS}}$)** checkbox.

Press the **Read** button in the **Configuration** group box to read the settings.

Status

In the **Status** group box, the **Read Back Error** group box displays the fault conditions from the readback error register of the MAX15501. The **Flag** group box displays the status of the $\overline{\text{ERROR}}$ and the $\overline{\text{READY}}$ pins. Press the **Read** button to update the **Status** group box. Check the **Automatic Read** checkbox to automatically update the **Status** group box every second.

During power-up, $\overline{\text{ERROR}}$ can go low and the brownout register is set. Users need to read out the error register twice to clear all the error register bits and reset $\overline{\text{ERROR}}$ to high.

Read/Write Command

The **Read/Write Command** group box displays the last command and data sent or received from the MAX15501 or the on-board DAC.

To send an SPI™ command to the MAX15501 or the on-board DAC, click on the appropriate radio button, enter the SPI command (hex value) in the **MOSI Data** edit box, and press the **Send Command** button.

MAX15501 Evaluation Kit

Evaluates: MAX15500/MAX15501

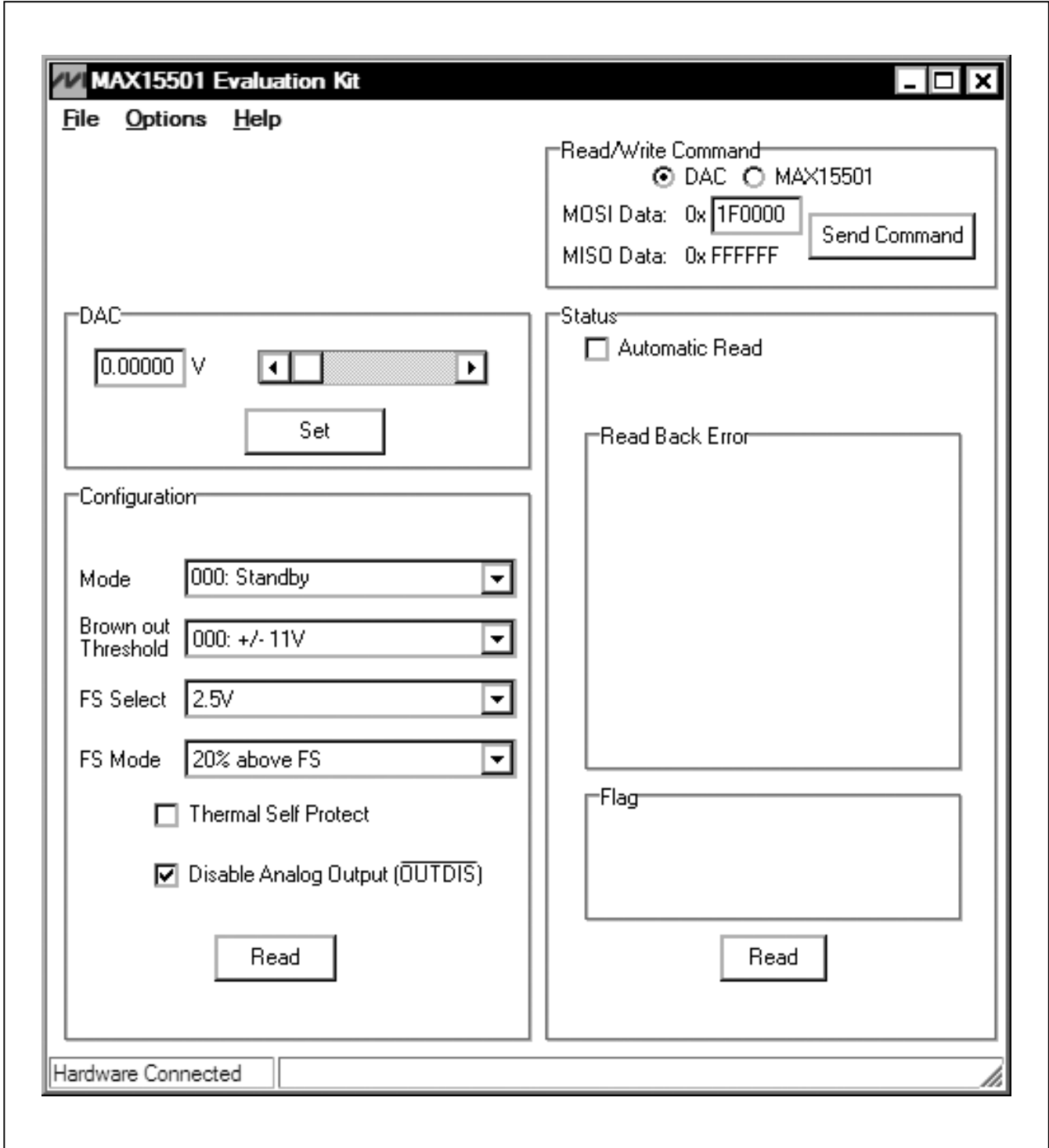

Figure 1. MAX15501 EV Kit Software Main Window

MAX15501 Evaluation Kit

Evaluates: MAX15500/MAX15501

Detailed Description of Hardware

The MAX15501 evaluation kit (EV kit) provides a proven design to evaluate the MAX15501 analog output conditioner that provides a programmable current up to $\pm 24\text{mA}$, or a voltage up to $\pm 12\text{V}$ proportional to a control voltage signal. The EV kit also includes Windows 2000, Windows XP-, and Windows Vista-compatible software that provide a simple graphical user interface (GUI) for exercising the features of the MAX15501.

The MAX15501 EV kit includes an on-board 16-bit DAC, a +2.5V on-board reference, a +4.096V on-board reference, an on-board microcontroller, digital interface headers, and an easy-to-use USB-PC connection.

Reference

The MAX15501 EV kit has two on-board voltage references (+2.5V and +4.096V). Jumper JU18 allows the user to select the reference voltage for both the on-board DAC and the MAX15501. See Table 3 for jumper descriptions.

Table 1. Pin Description of J2

PIN	SIGNAL	DEVICE
1	$\overline{\text{CS1}}$	MAX15501
2, 4, 6, 8, 10, 12, 14, 16, 18, 20	Digital ground	—
3	SCLK	MAX15501 and DAC
5	MOSI	MAX15501 and DAC
7	MISO	MAX15501
9	$\overline{\text{READY}}$	MAX15501
11	$\overline{\text{ERROR}}$	MAX15501
13	$\overline{\text{CS2}}$	MAX15501
15	$\overline{\text{LDAC}}$	DAC
17	$\overline{\text{CS}}$	DAC

Table 2. Sensing-Resistor Selection Jumper Settings

SENSING RESISTOR	JU27	JU28	JU29	JU30	JU31	JU32	JU33	JU34
RS1 (48.7 Ω)	Installed	Installed	Open	Open	Open	Open	Open	Open
RS2 (47.5 Ω)	Open	Open	Installed	Installed	Open	Open	Open	Open
RS3 (42.2 Ω)	Open	Open	Open	Open	Installed	Installed	Open	Open
RS4 (41.2 Ω)	Open	Open	Open	Open	Open	Open	Installed	Installed

On-Board DAC

By default, the analog signal input (AIN) of the MAX15501 connects to the output of an on-board 16-bit DAC (MAX5138). The output of the DAC can be programmed through the MAX15501 EV kit software. To apply an external signal to the AIN input of the MAX15501, move the shunt of JU13 to the 2-3 position and connect the external signal to the AIN pad.

User-Supplied Digital Interface

To use the MAX15501 EV kit with a user-supplied digital interface, first move the shunts of jumpers JU1, JU2, JU6–JU10, JU15, and JU16 to the 2-3 position. Then connect the user-supplied digital signals to the J2 connector. See Table 1 for the pin descriptions of the J2 connector.

Power Supply

Two power supplies are required to power up the MAX15501 EV kit. Connect the positive power supply (+15V to +32.5V) and the ground to the AVDD and the AGND pads, respectively. Connect the negative power supply (-15V to -32.5V) and the ground to the AVSS and the AGND pads on the MAX15501 EV kit, respectively.

By default, the digital power-supply inputs of the MAX15501 and the on-board DAC are powered from the USB port. To apply a user-supplied digital power supply to both of the MAX15501 and the on-board DAC, place a shunt on jumper JU12 in the 2-3 position and connect a +2.7V to +5.25V digital supply to the DVDD and the DGND pads.

Sensing Resistor

The MAX15501 EV kit includes four on-board sense resistors RS1 (48.7 Ω), RS2 (47.5 Ω), RS3 (42.2 Ω), and RS4 (41.2 Ω). See the jumper settings in Table 2 when selecting the on-board sensing resistor.

MAX15501 Evaluation Kit

Evaluates: MAX15500/MAX15501

Terminal Block

The MAX15501 EV kit provides a terminal block (J3) that can be used to connect to the external load. By default, the OUT signal of the MAX15501 connects to the OUTPUT pin (pin 1) of the terminal block through an on-board 41.2Ω sensing resistor (RS4).

The load should be connected between the OUTPUT (pin 1) and AGND (pin 2) pins of the terminal block. Pins

3 and 4 of the terminal block are the Kelvin sense voltage inputs (SENSEVP and SENSEVN) of the MAX15501. The load should also be connected between pins 3 and 4 of the terminal block.

Jumpers

To construct the *Typical Operating Circuit* from the MAX15501 IC data sheet, place shunts in their default positions, as shown in Table 3.

Table 3. Jumper Settings

JUMPER	SHUNT POSITION	DESCRIPTION
JU1	1-2*	MAX15501's $\overline{\text{ERROR}}$ signal connected to on-board microcontroller
	2-3	MAX15501's $\overline{\text{ERROR}}$ signal connected to the J2 connector (pin J2-11)
JU2	1-2*	MAX15501's $\overline{\text{READY}}$ signal connected to on-board microcontroller
	2-3	MAX15501's $\overline{\text{READY}}$ signal connected to the J2 connector (pin J2-9)
JU3	1-2*	MAX15501's $\overline{\text{OUTDIS}}$ signal connected to on-board microcontroller
	2-3	Connect external $\overline{\text{OUTDIS}}$ signal to the on-board $\overline{\text{OUTDIS}}$ pad
JU4	1-2	MAX15501's FSSEL connected to ground
	1-3*	MAX15501's FSSEL signal connected to on-board microcontroller
	1-4	MAX15501's FSSEL connected to DVDD
JU5	1-2	MAX15501's FSMODE connected to ground
	1-3*	MAX15501's FSMODE signal connected to on-board microcontroller
	1-4	MAX15501's FSMODE connected to DVDD
JU6	1-2*	MAX15501's $\overline{\text{CS1}}$ signal connected to on-board microcontroller
	2-3	Connect external $\overline{\text{CS1}}$ signal to pin J2-1 of the J2 connector
JU7	1-2*	SCLK signal connected to on-board microcontroller
	2-3	Connect external SCLK signal to pin J2-3 of the J2 connector
JU8	1-2*	MAX15501's DIN signal connected to on-board microcontroller
	2-3	Connect external MOSI signal to pin J2-5 of the J2 connector
JU9	1-2*	MAX15501's DOUT signal connected to on-board microcontroller
	2-3	Connect external MISO signal to pin J2-7 of the J2 connector
JU10	1-2*	MAX15501's $\overline{\text{CS2}}$ signal connected to on-board DAC's READY signal
	2-3	Connect external $\overline{\text{CS2}}$ signal to pin J2-13 of the J2 connector
JU12	1-2*	MAX15501's DVDD connected to on-board digital supply
	2-3	Connects the external DVDD to the DVDD pad
JU13	1-2*	MAX15501's AIN signal connected to on-board DAC output
	2-3	Connect external AIN signal to the on-board AIN pad
JU14	1-2*	The OUT signal of the MAX15501 connects to the OUTPUT pin of the J3 connector through a 5.1Ω resistor when the shunt is installed on jumper JU22
	2-3	MAX15501's output connected to the on-board OUT pad
JU15	1-2*	MAX15501's $\overline{\text{LDAC}}$ signal connected to on-board microcontroller
	2-3	Connect external $\overline{\text{LDAC}}$ signal to pin J2-15 of the J2 connector
JU16	1-2*	MAX15501's $\overline{\text{CS}}$ signal connected to on-board microcontroller
	2-3	Connect external $\overline{\text{CS}}$ signal to pin J2-17 of the J2 connector

MAX15501 Evaluation Kit

Evaluates: MAX15500/MAX15501

Table 3. Jumper Settings (continued)

JUMPER	SHUNT POSITION	DESCRIPTION
JU18	1-2	The +4.096V on-board voltage reference connected to the MAX5138 and the MAX15501
	1-3	Connect external voltage reference to the on-board DAC_REF pad
	1-4	Internal voltage reference of the MAX5138 connected to the MAX15501
	1-5*	The +2.5V on-board voltage reference connected to the MAX5138 and the MAX15501
JU19	1-2*	The OUT signal of the MAX15501 can be connected to the OUTPUT pin of the J3 connector through a sensing resistor. See the <i>Sensing Resistor</i> section for selecting the sense resistor.
	2-3	The SENSERP signal of the MAX15501 can be connected to ground
JU20	1-2*	Connects the SENSERN signal and the sensing resistor to the OUTPUT pin of the J3 connector
	2-3	Connects the SENSERN signal and the sensing resistor to ground
JU22	1-2	Bypasses the sensing resistor and connects the OUT signal of the MAX15501 to the OUTPUT pin of the J3 connector through a 5.1Ω resistor when the shunt is installed on pins 1-2 of the JU14
	Open*	The OUT signal of the MAX15501 can be connected to the OUTPUT pin of the J3 connector through a sensing resistor. See the <i>Sensing Resistor</i> section for selecting the sense resistor.
JU23	1-2	MAX15501's AVSSO connected to the AVSS
	Open*	Three diodes in series connected between AVSSO and AVSS
JU24	1-2	MAX15501's AVDDO connected to the AVDD
	Open*	Three diodes in series connected between AVDDO and AVDD
JU25	1-2*	On-board +4.096V voltage reference powered by on-board +5V supply
	2-3	Connects the external supply for the on-board +4.096V voltage reference to the REF_VIN pad
JU26	1-2*	On-board DAC powered by on-board +5V supply
	2-3	Connects the external supply for the on-board DAC to the DACVDD pad
JU27	1-2	Connects the RS1 resistor to pin 2 of JU19
	Open*	Disconnects the RS1 resistor from JU19
JU28	1-2	Connects the RS1 resistor to the SENSERP pin of the MAX15501
	Open*	Disconnects the RS1 resistor from the SENSERP pin of the MAX15501
JU29	1-2	Connects the RS2 resistor to pin 2 of JU19
	Open*	Disconnects the RS2 resistor from JU19
JU30	1-2	Connects the RS2 resistor to the SENSERP pin of the MAX15501
	Open*	Disconnects the RS2 resistor from the SENSERP pin of the MAX15501
JU31	1-2	Connects the RS3 resistor to pin 2 of JU19
	Open*	Disconnects the RS3 resistor from JU19
JU32	1-2	Connects the RS3 resistor to the SENSERP pin of the MAX15501
	Open*	Disconnects the RS3 resistor from the SENSERP pin of the MAX15501
JU33	1-2*	Connects the RS4 resistor to pin 2 of JU19
	Open	Disconnects the RS4 resistor from JU19
JU34	1-2*	Connects the RS4 resistor to the SENSERP pin of the MAX15501
	Open	Disconnects the RS4 resistor from the SENSERP pin of the MAX15501
JU35	1-2*	On-board +2.5V voltage reference powered by on-board +5V supply
	2-3	An external supply connected to the REF_VIN pad powers the on-board +2.5V voltage reference

*Default position.

MAX15501 Evaluation Kit

Evaluates: MAX15500/MAX15501

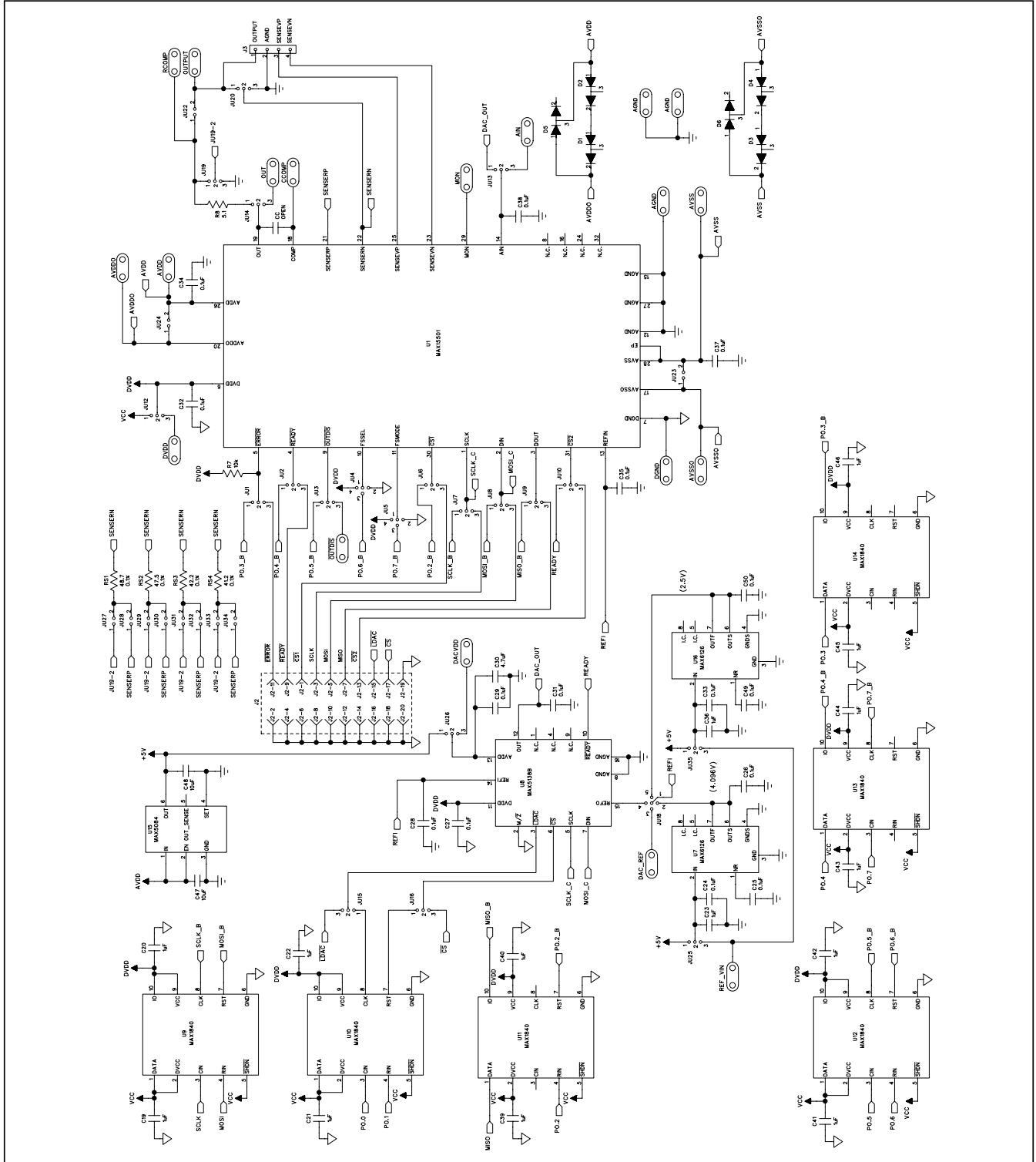

Figure 2a. MAX15501 EV Kit Schematic (Sheet 1 of 2)

MAX15501 Evaluation Kit

Evaluates: MAX15500/MAX15501

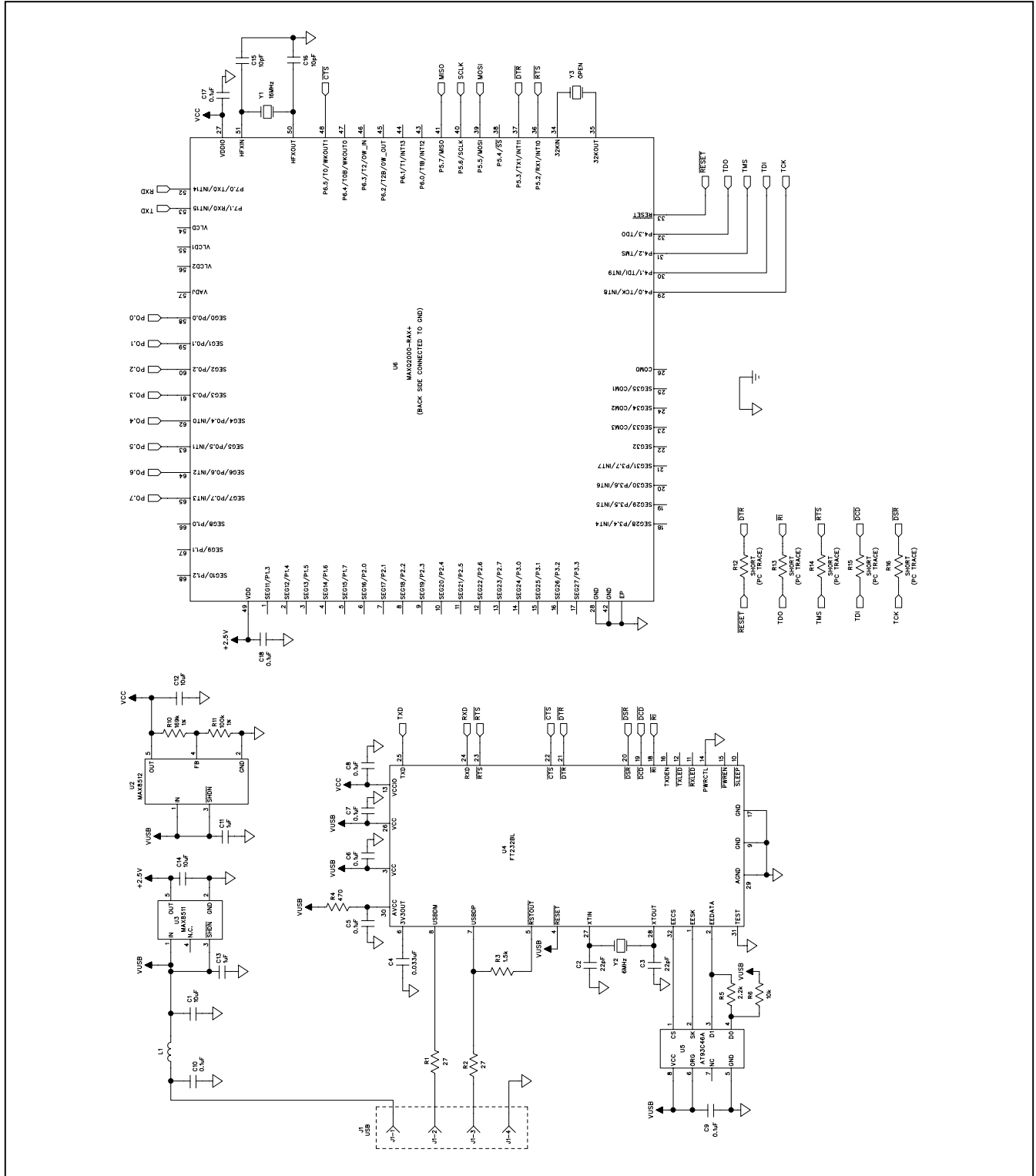

Figure 2b. MAX15501 EV Kit Schematic (Sheet 2 of 2)

MAX15501 Evaluation Kit

Evaluates: MAX15500/MAX15501

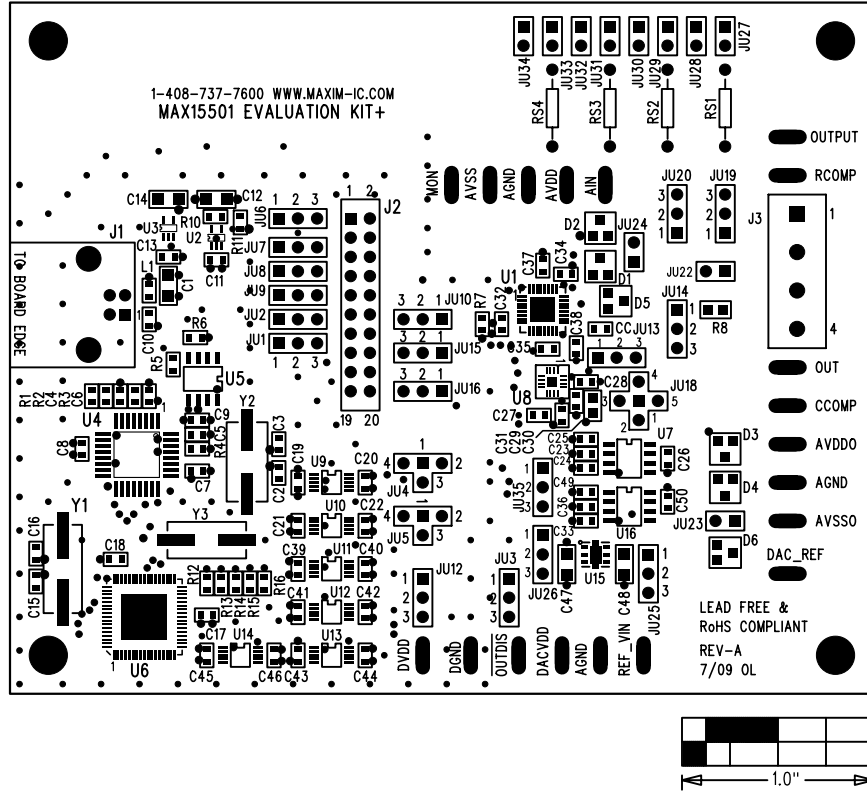

Figure 3. MAX15501 EV Kit Component Placement Guide—Component Side

MAX15501 Evaluation Kit

Evaluates: MAX15500/MAX15501

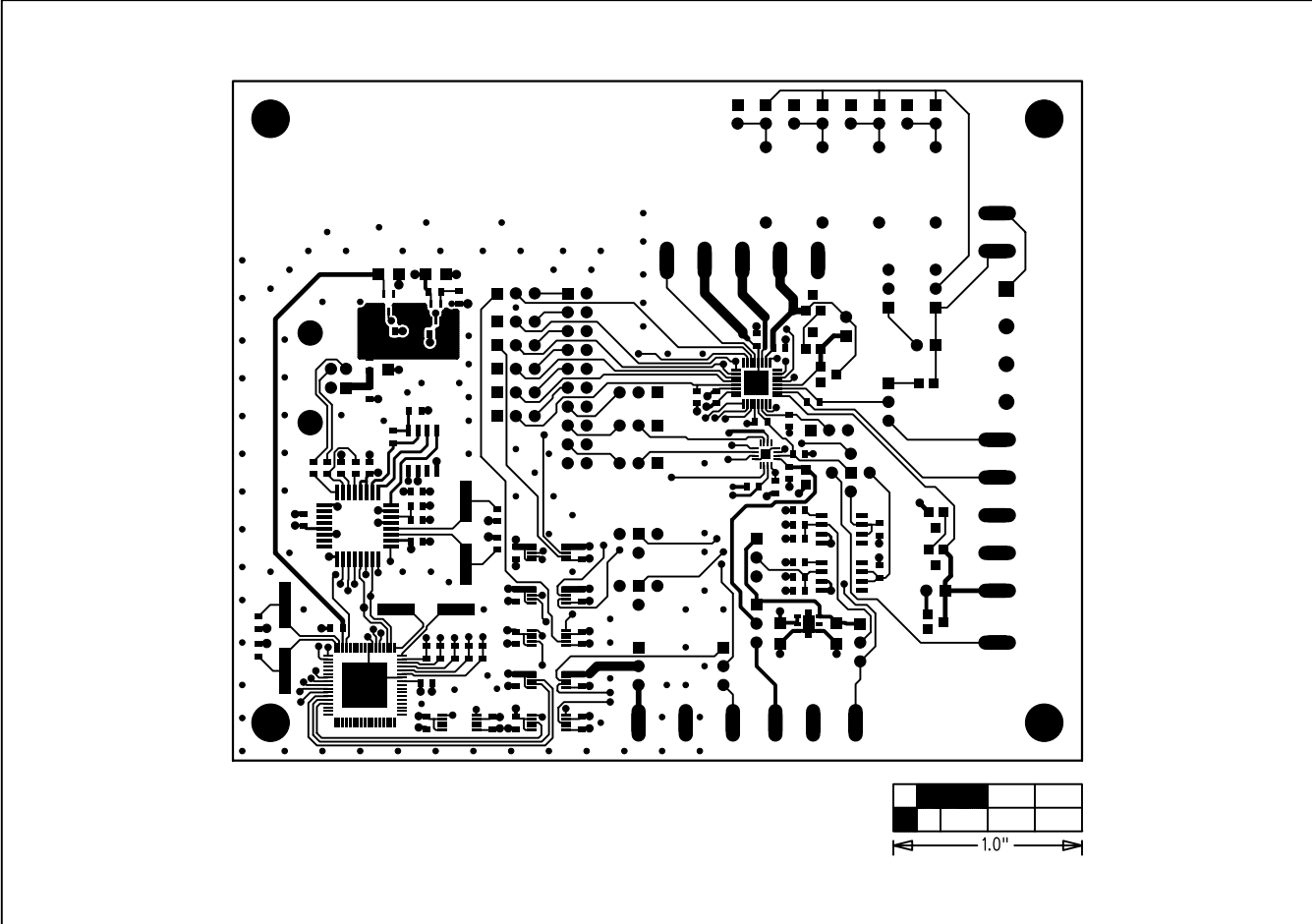

Figure 4. MAX15501 EV Kit PCB Layout—Component Side

MAX15501 Evaluation Kit

Evaluates: MAX15500/MAX15501

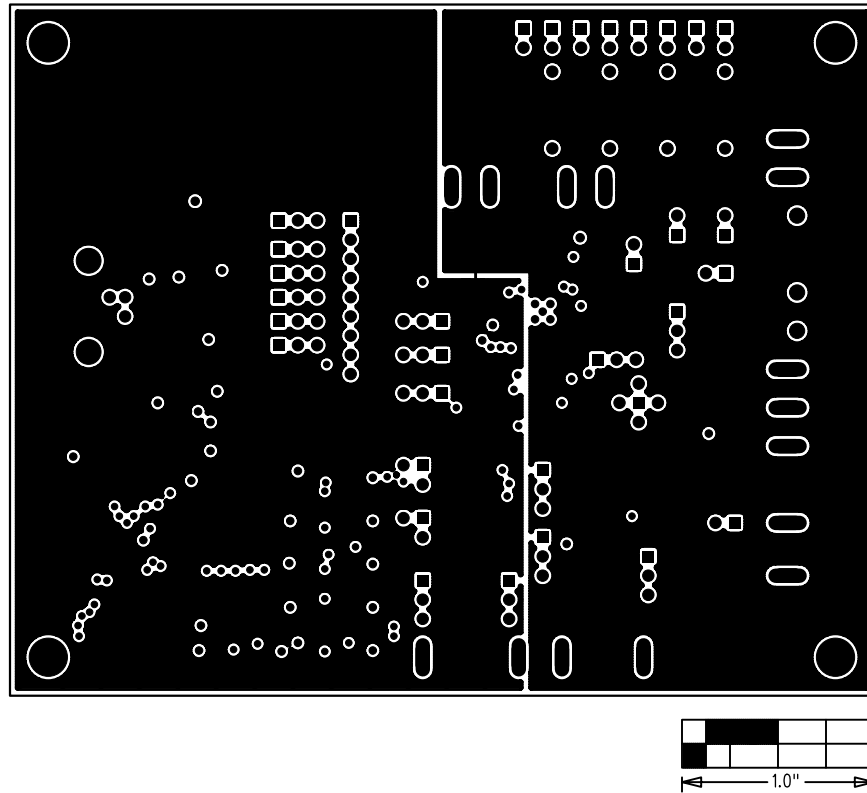

Figure 5. MAX15501 EV Kit PCB Layout—Layer 2

MAX15501 Evaluation Kit

Evaluates: MAX15500/MAX15501

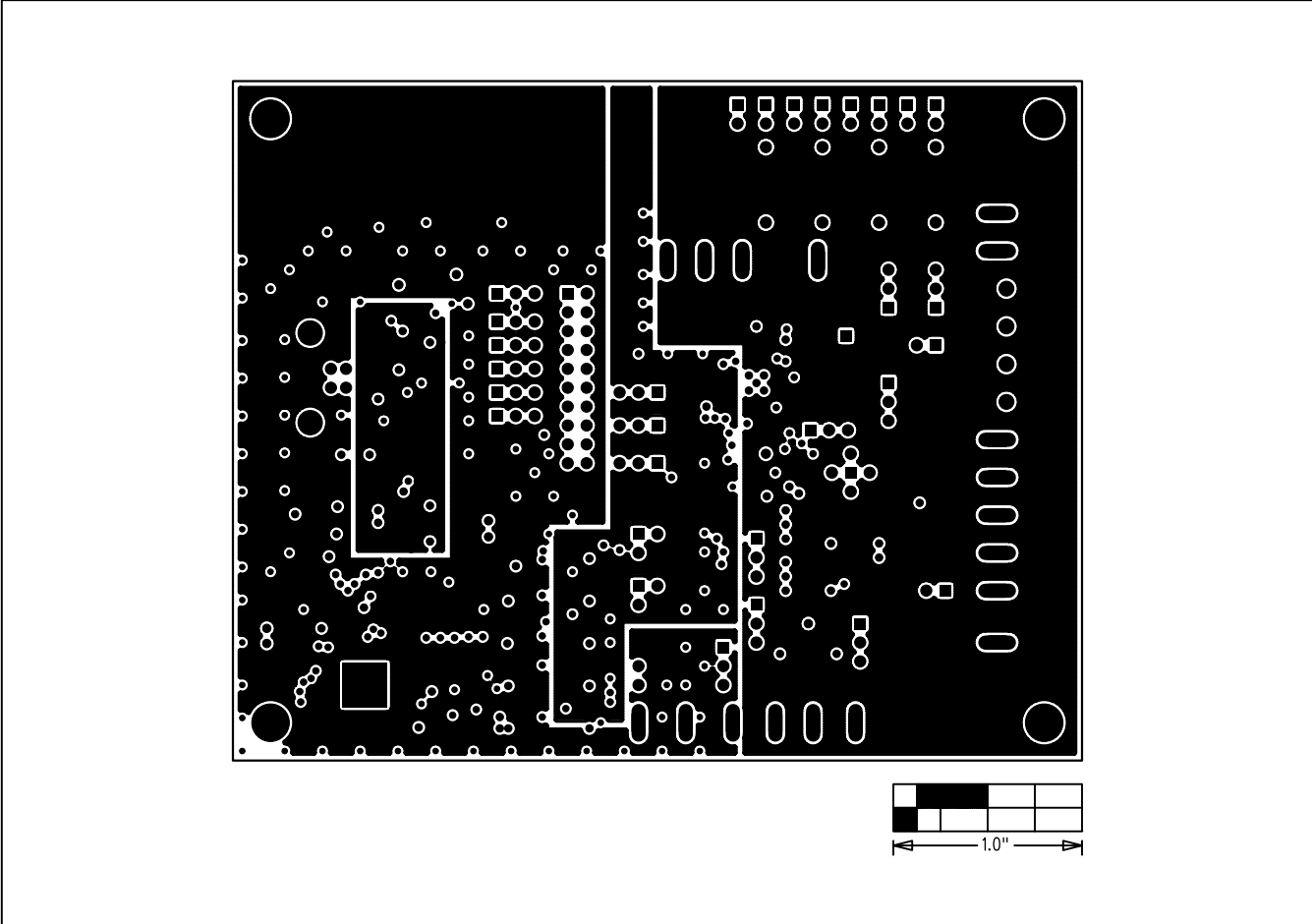

Figure 6. MAX15501 EV Kit PCB Layout—Layer 3

MAX15501 Evaluation Kit

Evaluates: MAX15500/MAX15501

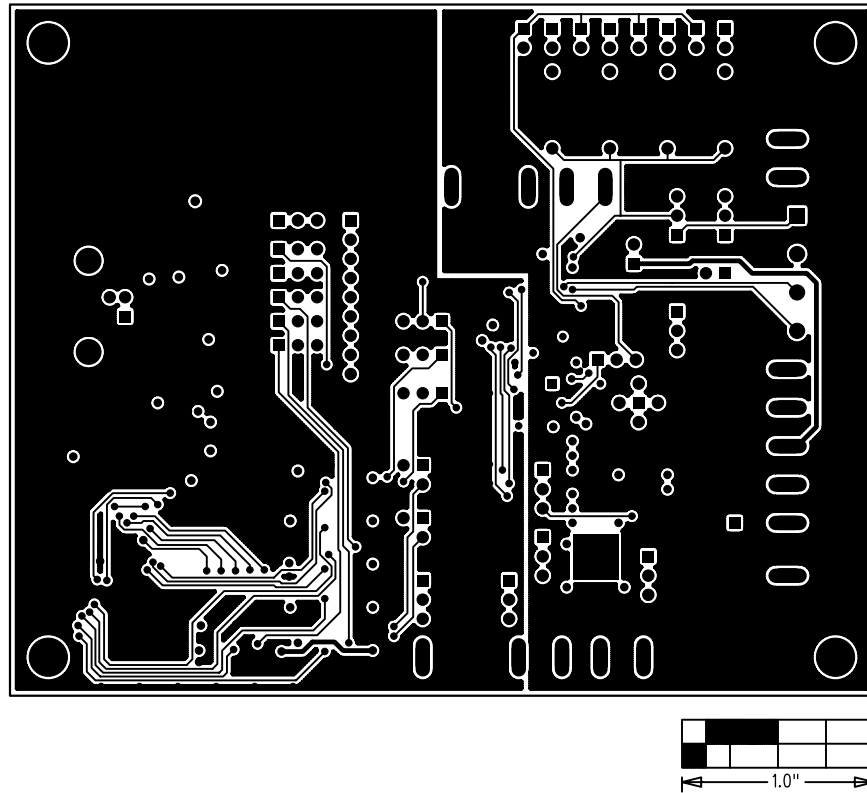

Figure 7. MAX15501 EV Kit PCB Layout—Solder Side



Maxim Integrated cannot assume responsibility for use of any circuitry other than circuitry entirely embodied in a Maxim Integrated product. No circuit patent licenses are implied. Maxim Integrated reserves the right to change the circuitry and specifications without notice at any time. The parametric values (min and max limits) shown in the Electrical Characteristics table are guaranteed. Other parametric values quoted in this data sheet are provided for guidance.

Maxim Integrated 160 Rio Robles, San Jose, CA 95134 USA 1-408-601-1000

15

© 2009 Maxim Integrated Products, Inc.

Maxim Integrated and the Maxim Integrated logo are trademarks of Maxim Integrated Products, Inc.