

APPROVED: \_\_\_\_\_  
 DATE: \_\_\_\_\_ TITLE: \_\_\_\_\_

Rev	AWO #	Description	Date	Appr
-		RELEASED	9/23/21	
A		UPDATE SPEC.	4/15/22	WX/RC
B		ADDED DRAWING	5/27/22	WX/RC

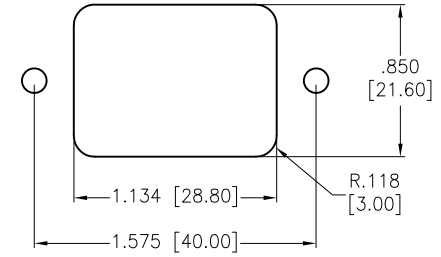

RECOMMENDED PANEL CUT

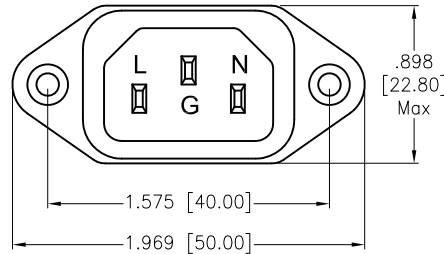
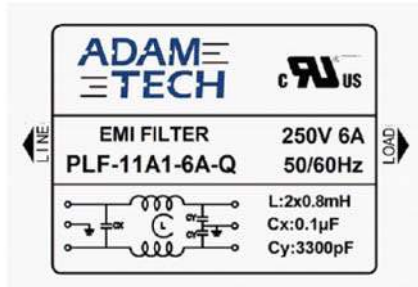
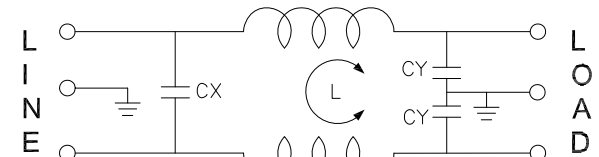
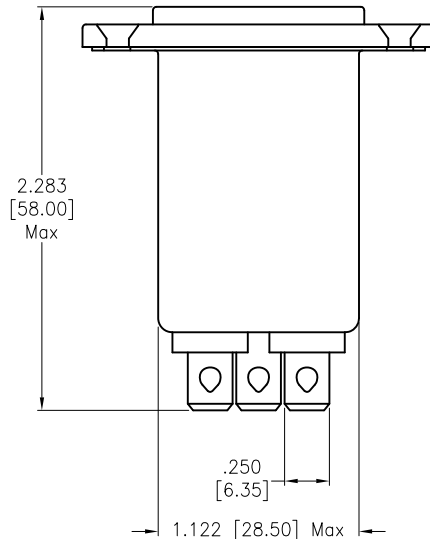
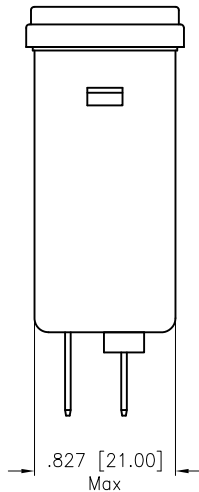

L: 2x0.8mH  
 Cx: 0.1uF(X2)  
 Cy: 3300pF(Y2)

**SPECIFICATIONS:**

**Electrical:**

Voltage rating: 115/250 VAC

Current rating: 115/250 VAC: 6A RMS max

Leakage Current: Each Line To Ground  
 @115VAC/60HZ 0.4mA max  
 @250VAC/50HZ 0.8mA max

Hipot Rating(For 1 Minute)

A. Line to Ground: 2,250 VDC

B. Line to Line: 1450 VDC

IR: 50 Mohm @500 VDC Any Input or Output to Ground

Temperature Rating:  
 -25°C to +85°C

Environmental:

Lead free, RoHS compliant



UNLESS OTHERWISE SPECIFIED ALL DIMENSIONS ARE INCHES [MM]. TOLERANCES: EXCEPT AS NOTED

INCHES		HOLES	
.X	± .10	ØX	±.10
.XX	± .020	Ø.XX	±.015
.XXX	± .015	Ø.XXX	±.010

DRAWN	WX	9/23/21
CHECKED	RC	9/23/21
APPROVED		

THIS DRAWING CONTAINS INFORMATION THAT IS PROPRIETARY AND SHOULD NOT BE USED WITHOUT PRIOR WRITTEN PERMISSION FROM ADAM TECH



909 Rahway Avenue,  
 Union, NJ 07083  
 Phone: 908-687-5000  
 Fax: 908-687-5710

TITLE  
**EMI/RF POWER FILTER, INLET SOCKET,  
 W/FLANGE MOUNTING**

SIZE	PART NO.	REV.
X	PLF-11A1-6A-Q	B

REF: S00205C SCALE: NTS SHEET 1 OF 2

6

5

4

3

2

1

APPROVED: \_\_\_\_\_

DATE: \_\_\_\_\_ TITLE: \_\_\_\_\_

Rev	AWO #	Description	Date	Appr
-----	-------	-------------	------	------

SEE SHT 1 OF 2 FOR REVISION

### INSERTION LOSS(IN 50 ohm system according IEC/CISPR

\_\_\_\_\_ (common mode)  
 - - - - - (differential mode)

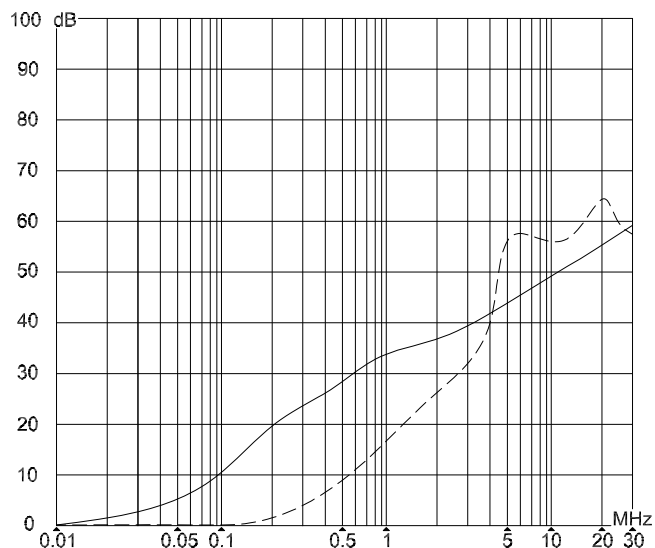

UNLESS OTHERWISE SPECIFIED ALL DIMENSIONS ARE INCHES [MM]. TOLERANCES: EXCEPT AS NOTED

INCHES		HOLES	
.x	± .10	∅x	± .10
.xx	± .020	∅xx	± .015
.xxx	± .015	∅xxx	± .010



909 Rahway Avenue,  
Union, NJ 07083  
Phone: 908-687-5000  
Fax: 908-687-5710

DRAWN	WX	9/23/21
CHECKED	RC	9/23/21
APPROVED		

TITLE  
**EM/RF POWER FILTER, INLET SOCKET,  
 W/FLANGE MOUNTING**

THIS DRAWING CONTAINS INFORMATION THAT IS PROPRIETARY AND SHOULD NOT BE USED WITHOUT PRIOR WRITTEN PERMISSION FROM ADAM TECH

SIZE <b>X</b>	PART NO. <b>PLF-11A1-6A-Q</b>	REV. <b>B</b>
------------------	----------------------------------	------------------

REF: S00205C	SCALE: NTS	SHEET 2 OF 2
--------------	------------	--------------

6

5

4

3

2

1