

2N5460, 2N5461, 2N5462

JFET Amplifier P-Channel – Depletion

Features

- Pb-Free Packages are Available*

MAXIMUM RATINGS

Rating	Symbol	Value	Unit
Drain – Gate Voltage	V_{DG}	40	Vdc
Reverse Gate – Source Voltage	V_{GSR}	40	Vdc
Forward Gate Current	$I_{G(f)}$	10	mAdc
Total Device Dissipation @ $T_A = 25^\circ\text{C}$ Derate above 25°C	P_D	350 2.8	mW mW/ $^\circ\text{C}$
Junction Temperature Range	T_J	-65 to +135	$^\circ\text{C}$
Storage Channel Temperature Range	T_{stg}	-65 to +150	$^\circ\text{C}$

Stresses exceeding Maximum Ratings may damage the device. Maximum Ratings are stress ratings only. Functional operation above the Recommended Operating Conditions is not implied. Extended exposure to stresses above the Recommended Operating Conditions may affect device reliability.



ON Semiconductor®

<http://onsemi.com>

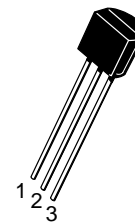
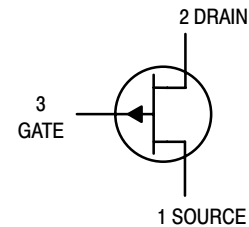

**TO-92
CASE 29
STYLE 7**

MARKING DIAGRAM

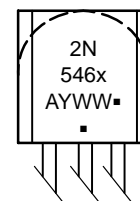

2N546x = Device Code

x = 0, 1, or 2

A = Assembly Location

Y = Year

WW = Work Week

■ = Pb-Free Package

(Note: Microdot may be in either location)

ORDERING INFORMATION

See detailed ordering and shipping information in the package dimensions section on page 2 of this data sheet.

Preferred devices are recommended choices for future use and best overall value.

*For additional information on our Pb-Free strategy and soldering details, please download the ON Semiconductor Soldering and Mounting Techniques Reference Manual, SOLDERRM/D.

2N5460, 2N5461, 2N5462

ELECTRICAL CHARACTERISTICS ($T_A = 25^\circ\text{C}$ unless otherwise noted)

Characteristic		Symbol	Min	Typ	Max	Unit
OFF CHARACTERISTICS						
Gate–Source Breakdown Voltage ($I_G = 10\ \mu\text{Adc}$, $V_{DS} = 0$)	2N5460, 2N5461, 2N5462	$V_{(BR)GSS}$	40	–	–	Vdc
Gate Reverse Current ($V_{GS} = 20\ \text{Vdc}$, $V_{DS} = 0$)	2N5460, 2N5461, 2N5462	I_{GSS}	–	–	5.0	nAdc
($V_{GS} = 30\ \text{Vdc}$, $V_{DS} = 0$)			–	–	1.0	μAdc
($V_{GS} = 20\ \text{Vdc}$, $V_{DS} = 0$, $T_A = 100^\circ\text{C}$)	2N5460, 2N5461, 2N5462		–	–	1.0	μAdc
($V_{GS} = 30\ \text{Vdc}$, $V_{DS} = 0$, $T_A = 100^\circ\text{C}$)			–	–	1.0	μAdc
Gate–Source Cutoff Voltage ($V_{DS} = 15\ \text{Vdc}$, $I_D = 1.0\ \mu\text{Adc}$)	2N5460 2N5461 2N5462	$V_{GS(off)}$	0.75 1.0 1.8	– – –	6.0 7.5 9.0	Vdc
Gate–Source Voltage ($V_{DS} = 15\ \text{Vdc}$, $I_D = 0.1\ \text{mAdc}$)	2N5460	V_{GS}	0.5	–	4.0	Vdc
($V_{DS} = 15\ \text{Vdc}$, $I_D = 0.2\ \text{mAdc}$)	2N5461		0.8	–	4.5	
($V_{DS} = 15\ \text{Vdc}$, $I_D = 0.4\ \text{mAdc}$)	2N5462		1.5	–	6.0	
ON CHARACTERISTICS						
Zero–Gate–Voltage Drain Current ($V_{DS} = 15\ \text{Vdc}$, $V_{GS} = 0$, $f = 1.0\ \text{kHz}$)	2N5460 2N5461 2N5462	I_{DSS}	–1.0 –2.0 –4.0	– – –	–5.0 –9.0 –16	mAdc
SMALL–SIGNAL CHARACTERISTICS						
Forward Transfer Admittance ($V_{DS} = 15\ \text{Vdc}$, $V_{GS} = 0$, $f = 1.0\ \text{kHz}$)	2N5460 2N5461 2N5462	$ y_{fs} $	1000 1500 2000	– – –	4000 5000 6000	μhos
Output Admittance ($V_{DS} = 15\ \text{Vdc}$, $V_{GS} = 0$, $f = 1.0\ \text{kHz}$)		$ y_{os} $	–	–	75	μhos
Input Capacitance ($V_{DS} = 15\ \text{Vdc}$, $V_{GS} = 0$, $f = 1.0\ \text{MHz}$)		C_{iss}	–	5.0	7.0	pF
Reverse Transfer Capacitance ($V_{DS} = 15\ \text{Vdc}$, $V_{GS} = 0$, $f = 1.0\ \text{MHz}$)		C_{rss}	–	1.0	2.0	pF
FUNCTIONAL CHARACTERISTICS						
Equivalent Short–Circuit Input Noise Voltage ($V_{DS} = 15\ \text{Vdc}$, $V_{GS} = 0$, $f = 100\ \text{Hz}$, $\text{BW} = 1.0\ \text{Hz}$)		e_n	–	60	115	$\text{nV}/\sqrt{\text{Hz}}$

ORDERING INFORMATION

Device	Package	Shipping†
2N5460	TO–92	1000 Units / Box
2N5460G	TO–92 (Pb–Free)	
2N5461	TO–92	
2N5461G	TO–92 (Pb–Free)	2000 / Tape & Reel
2N5461RLRA	TO–92	
2N5461RLRAG	TO–92 (Pb–Free)	1000 Units / Box
2N5462	TO–92	
2N5462G	TO–92 (Pb–Free)	

†For information on tape and reel specifications, including part orientation and tape sizes, please refer to our Tape and Reel Packaging Specifications Brochure, BRD8011/D.

DRAIN CURRENT versus GATE SOURCE VOLTAGE

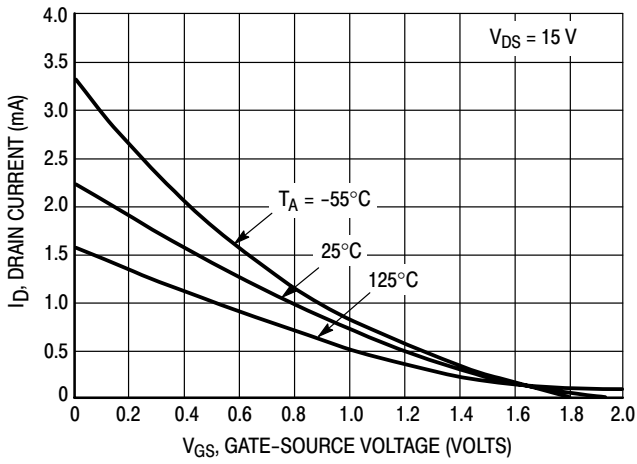

Figure 1. $V_{GS(off)} = 2.0\text{ V}$

FORWARD TRANSFER ADMITTANCE versus DRAIN CURRENT

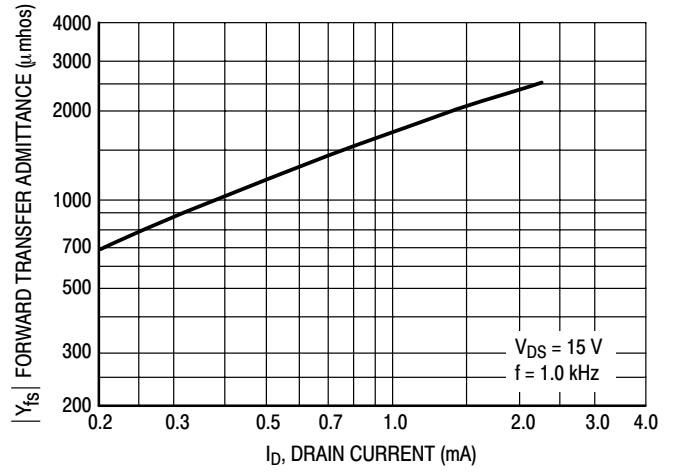

Figure 4. $V_{GS(off)} = 2.0\text{ V}$

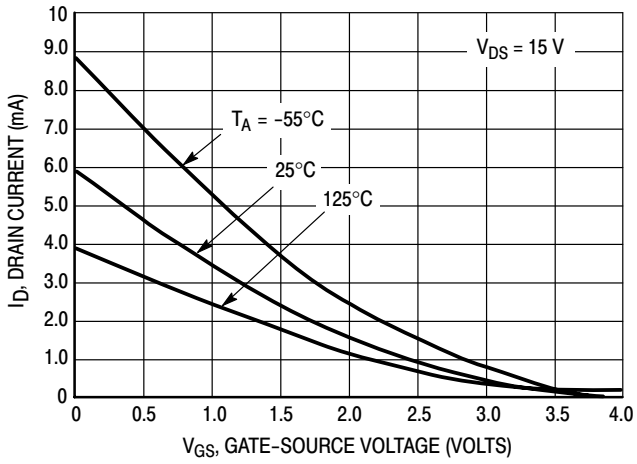

Figure 2. $V_{GS(off)} = 4.0\text{ V}$

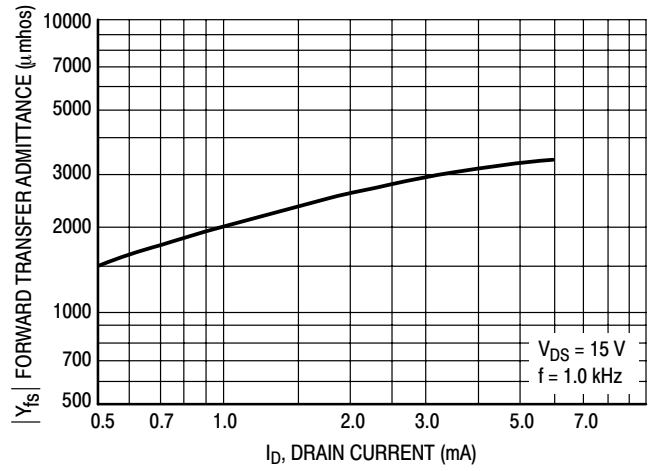

Figure 5. $V_{GS(off)} = 4.0\text{ V}$

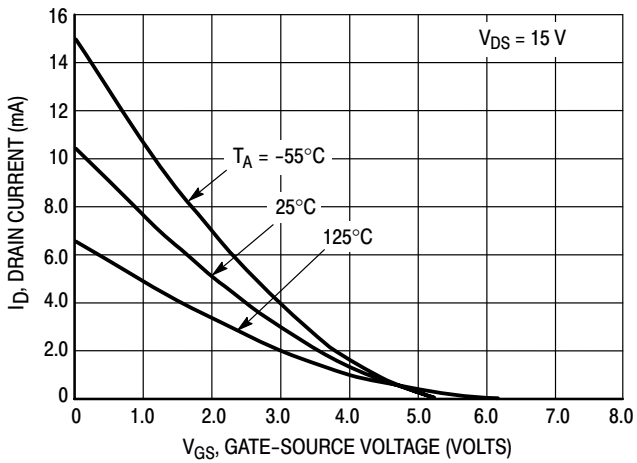

Figure 3. $V_{GS(off)} = 5.0\text{ V}$

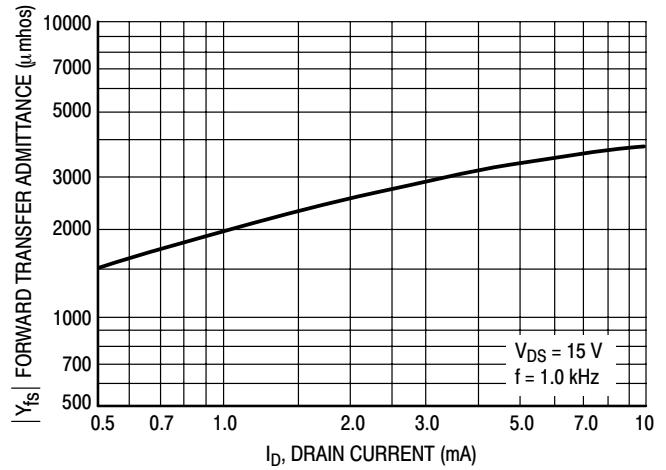

Figure 6. $V_{GS(off)} = 5.0\text{ V}$

2N5460, 2N5461, 2N5462

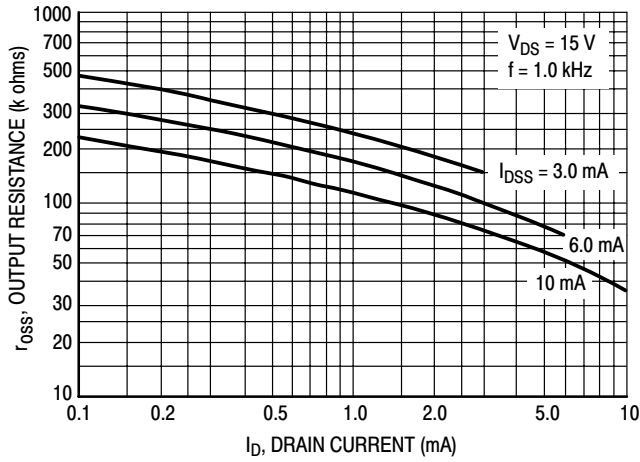

Figure 7. Output Resistance versus Drain Current

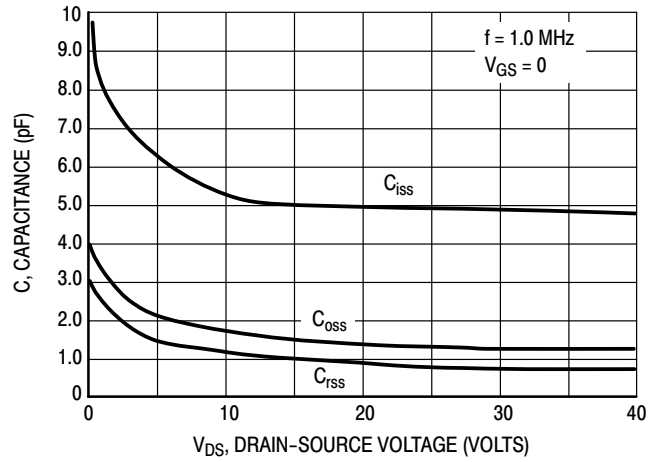

Figure 8. Capacitance versus Drain-Source Voltage

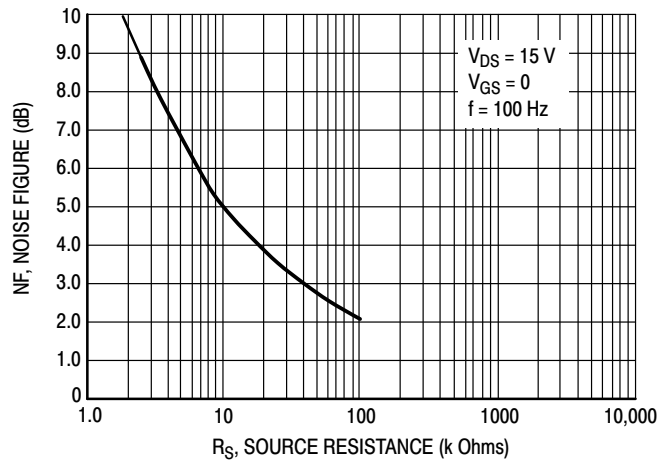
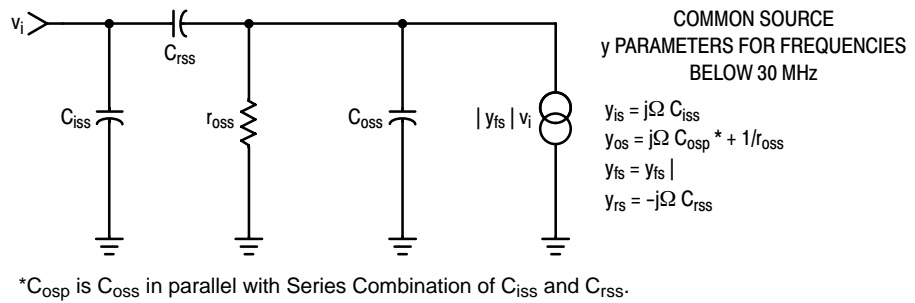

Figure 9. Noise Figure versus Source Resistance



NOTE:

1. Graphical data is presented for dc conditions. Tabular data is given for pulsed conditions (Pulse Width = 630 ms, Duty Cycle = 10%).

Figure 10. Equivalent Low Frequency Circuit

2N5460, 2N5461, 2N5462

PACKAGE DIMENSIONS

TO-92
CASE 29-11
ISSUE AL

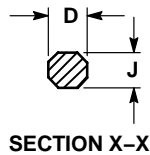
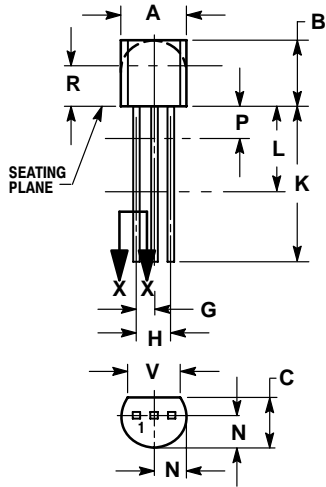

NOTES:

1. DIMENSIONING AND TOLERANCING PER ANSI Y14.5M, 1982.
2. CONTROLLING DIMENSION: INCH.
3. CONTOUR OF PACKAGE BEYOND DIMENSION R IS UNCONTROLLED.
4. LEAD DIMENSION IS UNCONTROLLED IN P AND BEYOND DIMENSION K MINIMUM.

DIM	INCHES		MILLIMETERS	
	MIN	MAX	MIN	MAX
A	0.175	0.205	4.45	5.20
B	0.170	0.210	4.32	5.33
C	0.125	0.165	3.18	4.19
D	0.016	0.021	0.407	0.533
G	0.045	0.055	1.15	1.39
H	0.095	0.105	2.42	2.66
J	0.015	0.020	0.39	0.50
K	0.500	---	12.70	---
L	0.250	---	6.35	---
N	0.080	0.105	2.04	2.66
P	---	0.100	---	2.54
R	0.115	---	2.93	---
V	0.135	---	3.43	---

STYLE 7:

1. SOURCE
2. DRAIN
3. GATE

ON Semiconductor and are registered trademarks of Semiconductor Components Industries, LLC (SCILLC). SCILLC reserves the right to make changes without further notice to any products herein. SCILLC makes no warranty, representation or guarantee regarding the suitability of its products for any particular purpose, nor does SCILLC assume any liability arising out of the application or use of any product or circuit, and specifically disclaims any and all liability, including without limitation special, consequential or incidental damages. "Typical" parameters which may be provided in SCILLC data sheets and/or specifications can and do vary in different applications and actual performance may vary over time. All operating parameters, including "Typicals" must be validated for each customer application by customer's technical experts. SCILLC does not convey any license under its patent rights nor the rights of others. SCILLC products are not designed, intended, or authorized for use as components in systems intended for surgical implant into the body, or other applications intended to support or sustain life, or for any other application in which the failure of the SCILLC product could create a situation where personal injury or death may occur. Should Buyer purchase or use SCILLC products for any such unintended or unauthorized application, Buyer shall indemnify and hold SCILLC and its officers, employees, subsidiaries, affiliates, and distributors harmless against all claims, costs, damages, and expenses, and reasonable attorney fees arising out of, directly or indirectly, any claim of personal injury or death associated with such unintended or unauthorized use, even if such claim alleges that SCILLC was negligent regarding the design or manufacture of the part. SCILLC is an Equal Opportunity/Affirmative Action Employer. This literature is subject to all applicable copyright laws and is not for resale in any manner.

PUBLICATION ORDERING INFORMATION

LITERATURE FULFILLMENT:
Literature Distribution Center for ON Semiconductor
P.O. Box 61312, Phoenix, Arizona 85082-1312 USA
Phone: 480-829-7710 or 800-344-3860 Toll Free USA/Canada
Fax: 480-829-7709 or 800-344-3867 Toll Free USA/Canada
Email: orderlit@onsemi.com

N. American Technical Support: 800-282-9855 Toll Free USA/Canada

Japan: ON Semiconductor, Japan Customer Focus Center
2-9-1 Kamimeguro, Meguro-ku, Tokyo, Japan 153-0051
Phone: 81-3-5773-3850

ON Semiconductor Website: <http://onsemi.com>

Order Literature: <http://www.onsemi.com/litorder>

For additional information, please contact your local Sales Representative.