

Features

- Epitaxial Planar Die Construction
- Low Collector-Emitter Saturation Voltage, $V_{CE(SAT)}$
- Complementary PNP Type Available (DSS5160U)
- Ultra-Small Surface Mount Package
- **Lead Free By Design/RoHS Compliant (Note 1)**
- **"Green Device" (Note 2)**



Top View

Mechanical Data

- Case: SOT-323
- Case Material: Molded Plastic, "Green" Molding Compound. UL Flammability Classification Rating 94V-0
- Moisture Sensitivity: Level 1 per J-STD-020D
- Terminals: Finish — Matte Tin annealed over Copper Plated Alloy 42 leadframe. Solderable per MIL-STD-202, Method 208
- Terminal Connections: See Diagram
- Marking Information: See Page 4
- Ordering Information: See Page 4
- Weight: 0.006 grams (approximate)

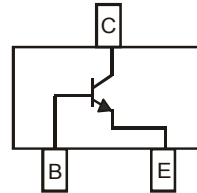

Device Schematic

Maximum Ratings @ $T_A = 25^\circ\text{C}$ unless otherwise specified

| Characteristic | Symbol | Value | Unit |
|--------------------------------|-----------|-------|------|
| Collector-Base Voltage | V_{CBO} | 80 | V |
| Collector-Emitter Voltage | V_{CEO} | 60 | V |
| Emitter-Base Voltage | V_{EBO} | 5 | V |
| Collector Current - Continuous | I_C | 1 | A |
| Peak Pulse Collector Current | I_{CM} | 2 | A |
| Base Current (DC) | I_B | 300 | mA |
| Peak Base Current | I_{BM} | 1 | A |

Thermal Characteristics

| Characteristic | Symbol | Value | Unit |
|---|-----------------|-------------|---------------------------|
| Power Dissipation (Note 3) @ $T_A = 25^\circ\text{C}$ | P_D | 400 | mW |
| Thermal Resistance, Junction to Ambient (Note 3) @ $T_A = 25^\circ\text{C}$ | $R_{\theta JA}$ | 313 | $^\circ\text{C}/\text{W}$ |
| Operating and Storage Temperature Range | T_J, T_{STG} | -55 to +150 | $^\circ\text{C}$ |

- Notes:
1. No purposefully added lead.
 2. Diode's Inc.'s "Green" policy can be found on our website at http://www.diodes.com/products/lead_free/index.php.
 3. Device mounted on FR-4 PCB with minimum recommended pad layout.

Electrical Characteristics @ $T_A = 25^\circ\text{C}$ unless otherwise specified

| Characteristic | Symbol | Min | Typ | Max | Unit | Test Condition |
|--|---------------|-------------------|-------------|-------------------|---------------------|---|
| OFF CHARACTERISTICS | | | | | | |
| Collector-Base Breakdown Voltage | $V_{(BR)CBO}$ | 80 | — | — | V | $I_C = 100\mu\text{A}, I_E = 0$ |
| Collector-Emitter Breakdown Voltage (Note 4) | $V_{(BR)CEO}$ | 60 | — | — | V | $I_C = 10\text{mA}, I_B = 0$ |
| Emitter-Base Breakdown Voltage | $V_{(BR)EBO}$ | 5 | — | — | V | $I_E = 100\mu\text{A}, I_C = 0$ |
| Collector Cutoff Current | I_{CBO} | — | — | 100 50 | nA μA | $V_{CB} = 60\text{V}, I_E = 0$ $V_{CB} = 60\text{V}, I_E = 0, T_A = 150^\circ\text{C}$ |
| Collector Cutoff Current | I_{CES} | — | — | 100 | nA | $V_{CE} = 60\text{V}, V_{BE} = 0$ |
| Emitter Cutoff Current | I_{EBO} | — | — | 100 | nA | $V_{EB} = 5\text{V}, I_C = 0$ |
| ON CHARACTERISTICS (Note 4) | | | | | | |
| DC Current Gain | h_{FE} | 250 200 100 | — — — | — — — | — | $V_{CE} = 5\text{V}, I_C = 1\text{mA}$ $V_{CE} = 5\text{V}, I_C = 500\text{mA}$ $V_{CE} = 5\text{V}, I_C = 1\text{A}$ |
| Collector-Emitter Saturation Voltage | $V_{CE(SAT)}$ | — — — | — — — | 115 150 280 | mV | $I_C = 100\text{mA}, I_B = 1\text{mA}$ $I_C = 500\text{mA}, I_B = 50\text{mA}$ $I_C = 1\text{A}, I_B = 100\text{mA}$ |
| Collector-Emitter Saturation Resistance | $R_{CE(SAT)}$ | — | — | 280 | m Ω | $I_C = 1\text{A}, I_B = 100\text{mA}$ |
| Base-Emitter Saturation Voltage | $V_{BE(SAT)}$ | — | — | 1.1 | V | $I_C = 1\text{A}, I_B = 50\text{mA}$ |
| Base-Emitter Turn On Voltage | $V_{BE(ON)}$ | — | — | 0.9 | V | $V_{CE} = 5\text{V}, I_C = 1\text{A}$ |
| SMALL SIGNAL CHARACTERISTICS | | | | | | |
| Output Capacitance | C_{obo} | — | — | 10 | pF | $V_{CB} = 10\text{V}, f = 1.0\text{MHz}$ |
| Current Gain-Bandwidth Product | f_T | 150 | — | — | MHz | $V_{CE} = 10\text{V}, I_C = 50\text{mA}, f = 100\text{MHz}$ |
| SWITCHING CHARACTERISTICS | | | | | | |
| Turn-On Time | t_{on} | — | 63 | — | ns | $V_{CC} = 10\text{V}$ $I_C = 0.5\text{A}, I_{B1} = I_{B2} = 25\text{mA}$ |
| Delay Time | t_d | — | 33 | — | ns | |
| Rise Time | t_r | — | 30 | — | ns | |
| Turn-Off Time | t_{off} | — | 420 | — | ns | |
| Storage Time | t_s | — | 380 | — | ns | |
| Fall Time | t_f | — | 40 | — | ns | |

Notes: 4. Measured under pulsed conditions. Pulse width = 300 μs . Duty cycle $\leq 2\%$.

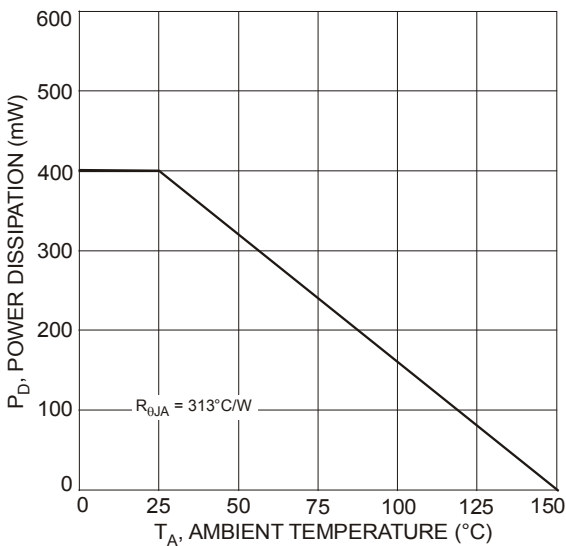

Fig. 1 Power Dissipation vs. Ambient Temperature (Note 3)

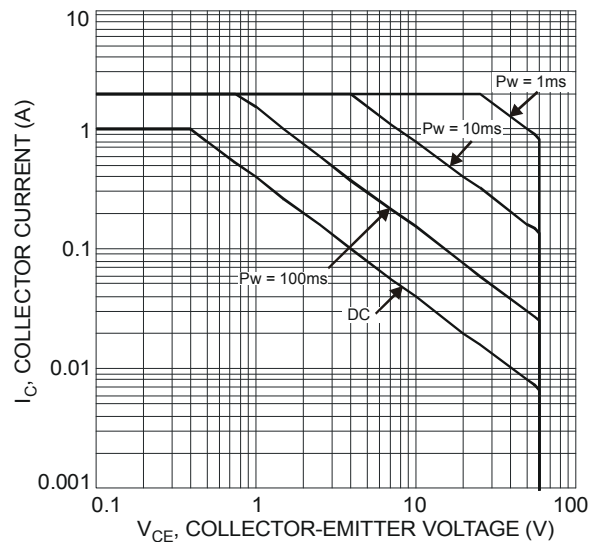

Fig. 2 Typical Collector Current vs. Collector-Emitter Voltage (Note 3)

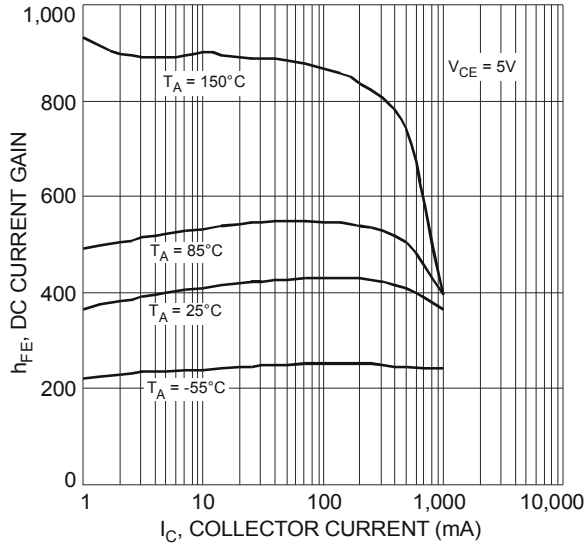

Fig. 3 Typical DC Current Gain vs. Collector Current

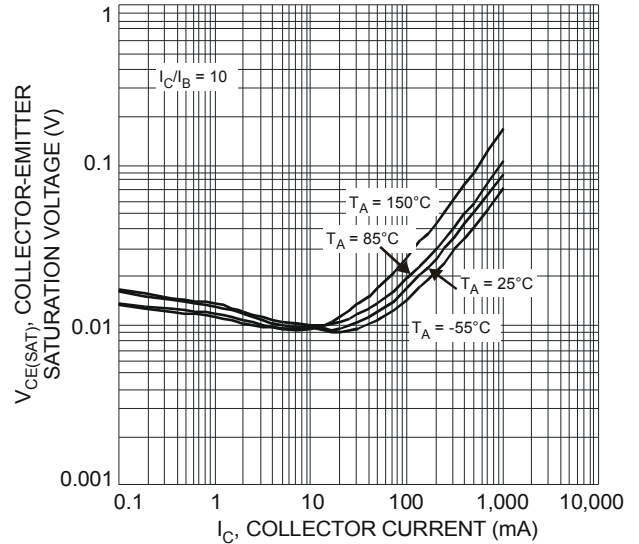

Fig. 4 Typical Collector-Emitter Saturation Voltage vs. Collector Current

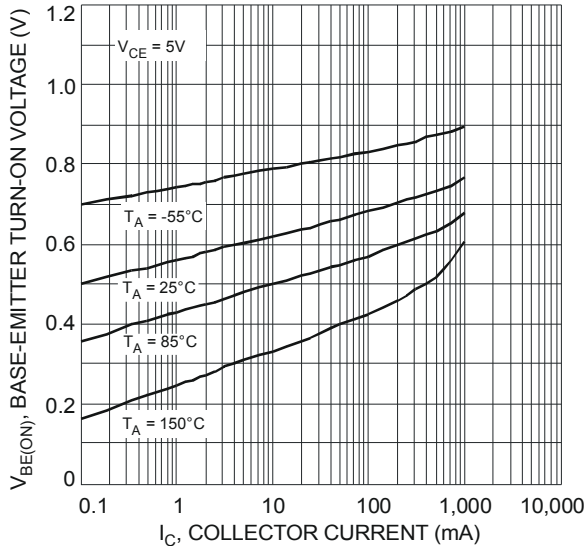

Fig. 5 Typical Base-Emitter Turn-On Voltage vs. Collector Current

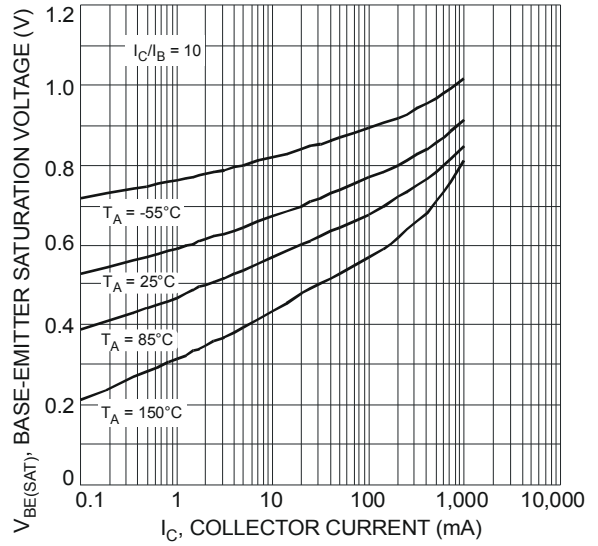

Fig. 6 Typical Base-Emitter Saturation Voltage vs. Collector Current

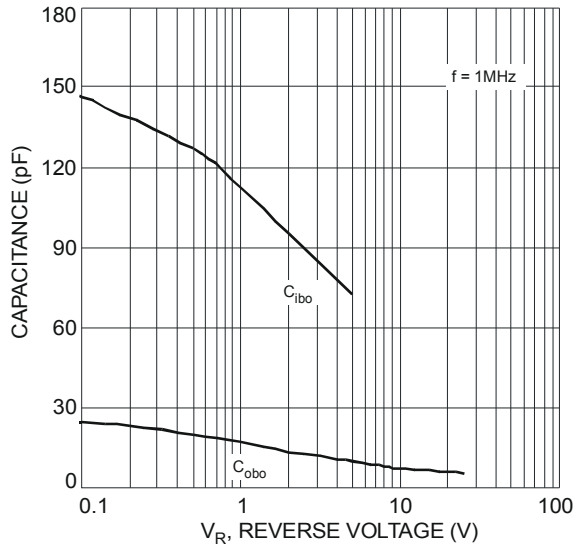

Fig. 7 Typical Capacitance Characteristics

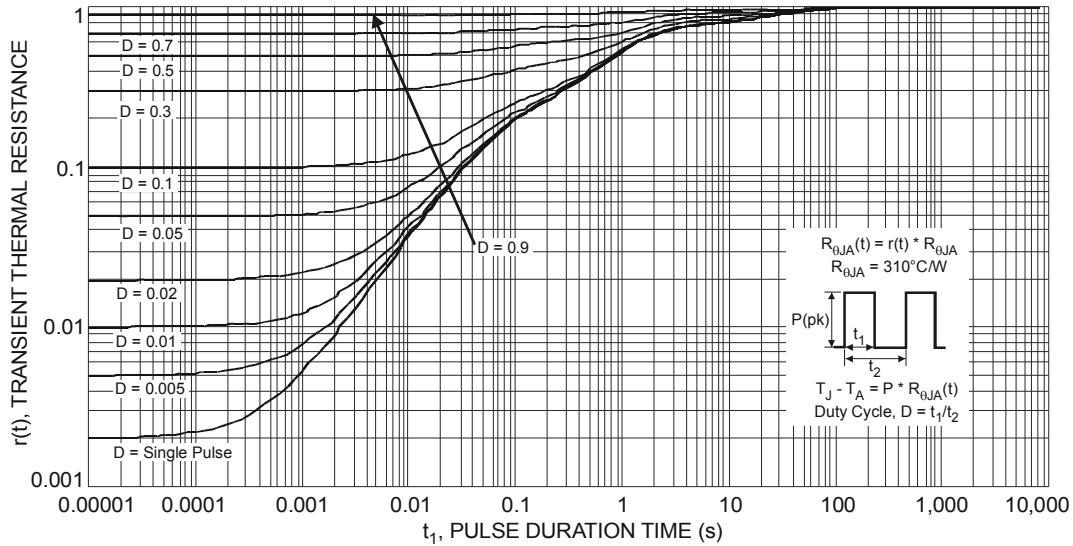

Fig. 8 Transient Thermal Response (Note 3)

Ordering Information (Note 5)

| Part Number | Case | Packaging |
|-------------|---------|------------------|
| DSS4160U-7 | SOT-323 | 3000/Tape & Reel |

Notes: 5. For packaging details, go to our website at <http://www.diodes.com/datasheets/ap02007.pdf>.

Marking Information

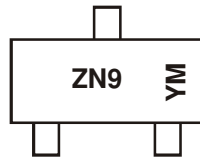

ZN9 = Product Type Marking Code
 YM = Date Code Marking
 Y = Year (ex: V = 2008)
 M = Month (ex: 9 = September)

Date Code Key

| Year | 2008 | 2009 | 2010 | 2011 | 2012 | 2013 | 2014 | 2015 |
|------|------|------|------|------|------|------|------|------|
| Code | V | W | X | Y | Z | A | B | C |

| Month | Jan | Feb | Mar | Apr | May | Jun | Jul | Aug | Sep | Oct | Nov | Dec |
|-------|-----|-----|-----|-----|-----|-----|-----|-----|-----|-----|-----|-----|
| Code | 1 | 2 | 3 | 4 | 5 | 6 | 7 | 8 | 9 | O | N | D |

Package Outline Dimensions

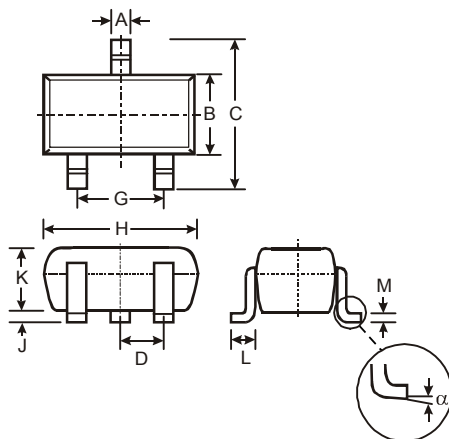

| SOT-323 | | | |
|---------|------|------|------|
| Dim | Min | Max | Typ |
| A | 0.25 | 0.40 | 0.30 |
| B | 1.15 | 1.35 | 1.30 |
| C | 2.00 | 2.20 | 2.10 |
| D | - | - | 0.65 |
| G | 1.20 | 1.40 | 1.30 |
| H | 1.80 | 2.20 | 2.15 |
| J | 0.0 | 0.10 | 0.05 |
| K | 0.90 | 1.00 | 1.00 |
| L | 0.25 | 0.40 | 0.30 |
| M | 0.10 | 0.18 | 0.11 |
| α | 0° | 8° | - |

All Dimensions in mm

Suggested Pad Layout

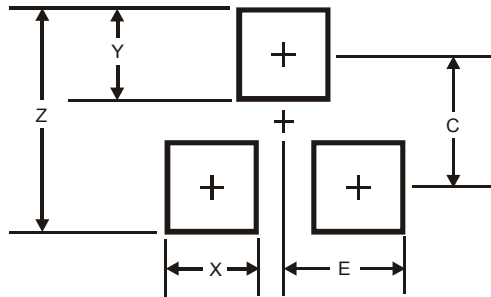

| Dimensions | Value (in mm) |
|------------|---------------|
| Z | 2.8 |
| X | 0.7 |
| Y | 0.9 |
| C | 1.9 |
| E | 1.0 |

IMPORTANT NOTICE

Diodes Incorporated and its subsidiaries reserve the right to make modifications, enhancements, improvements, corrections or other changes without further notice to any product herein. Diodes Incorporated does not assume any liability arising out of the application or use of any product described herein; neither does it convey any license under its patent rights, nor the rights of others. The user of products in such applications shall assume all risks of such use and will agree to hold Diodes Incorporated and all the companies whose products are represented on our website, harmless against all damages.

LIFE SUPPORT

Diodes Incorporated products are not authorized for use as critical components in life support devices or systems without the expressed written approval of the President of Diodes Incorporated.

NEW PRODUCT