

THESE DRAWINGS ARE THE PROPERTY OF QUALTEK ELECTRONICS AND NOT TO BE REPRODUCED FOR OR COMMUNICATED TO A THIRD PARTY WITHOUT THE EXPRESS WRITTEN PERMISSION OF AN OFFICER OF QUALTEK ELECTRONICS.

REVISION			
REV.	DESCRIPTION	DATE	APPROVED

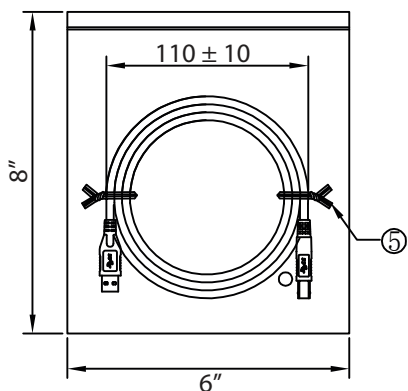
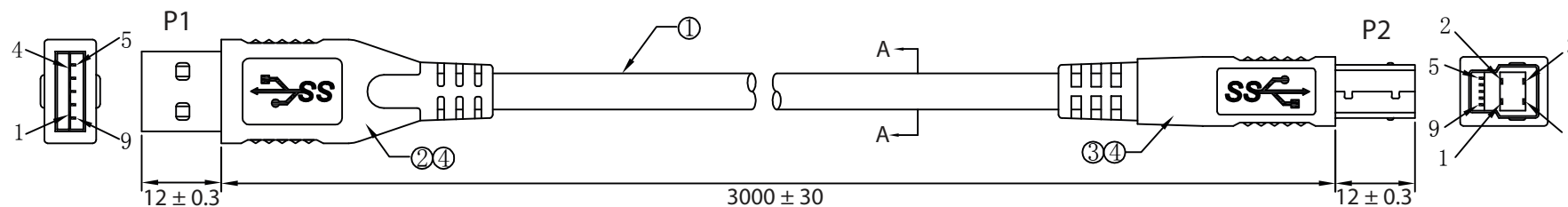

WIRING:

P1	COLOR	P2
VBUS 1	RED	1 VBUS
D- 2	WHITE	2 D-
D+ 3	GREEN	3 D+
GND 4	BLACK	4 GND
StdA_SSRX- 5	BLUE	5 StdA_SSTX-
StdA_SSRX+ 6	YELLOW	6 StdA_SSTX+
GND_DRAIN 7	DRAIN	7 GND_DRAIN
StdA_SSTX- 8	PURPLE	8 StdA_SSRX-
StdA_SSTX+ 9	ORANGE	9 StdA_SSRX+
SHIELD	BRAID	SHIELD

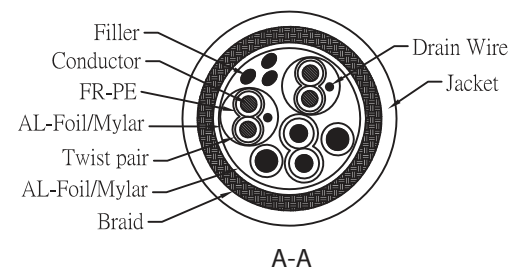

CONTROLLED

No.	PARTS NAME	SPECIFICATION STANDARD	QTY	REMARKS
①	CABLE	UL 20276 O.D. 5.5mm COLOR: BLACK	1	
②	USB3.0 A M 9PIN GOLD PLATED	30U" SHELL NICKEL PLATED INSULATOR BLUE	1	
③	USB3.0 B M 9PIN GOLD PLATED	30U" SHELL NICKEL PLATED INSULATOR BLUE	1	
④	PVC	45P PVC BLACK	14	g
⑤	CABLE TIE	L=9cm COLOR: BLACK	2	

NOTES:

- CABLE: UL20276
(1Px30AWG+D+AL+MY)x2C+1Px30AWG+2Cx24AWG+AL+B
OUTER JACKET: BLACK, O.D.: 5.5mm
- CONNECTORS: USB 3.0 A MALE TO USB 3.0 B MALE
- HOOD: MOLDED TYPE, COLOR: BLACK
- PACKING: 1PC/POLYBAG
- RoHS COMPLIANT

Dim range (mm)	Tolerance +/- (mm)	Qualtek Electronics Corp. WCI DIVISION		
		Part Number: 3023027-03M		RoHS Compliant
0-1	0.15	Description: USB 3.0 A/M - USB 3.0 B/M		
1-6	0.20	UNIT: mm		
6-18	0.30			
18-50	0.50			
50-120	0.70	Drawn / Date	Checked / Date	Approved / Date
120-250	0.90	R.Nuti 06-25-10	06-25-10	LY / 06-25-10
250-500	1.20			