

CDSFR4448-HF

$I_o = 125 \text{ mA}$

$V_R = 80 \text{ Volts}$

RoHS Device

Halogen Free



Features

- Fast Switching Speed
- Designed for mounting on small surface.
- Extremely thin/leadless package.

Mechanical data

- Case: 1005/SOD-323F standard package, molded plastic.
- Terminals: Gold plated, solderable per MIL-STD-750, method 2026.
- Polarity: Indicated by cathode band.
- Mounting position: Any.
- Weight: 0.006 grams (approx.).

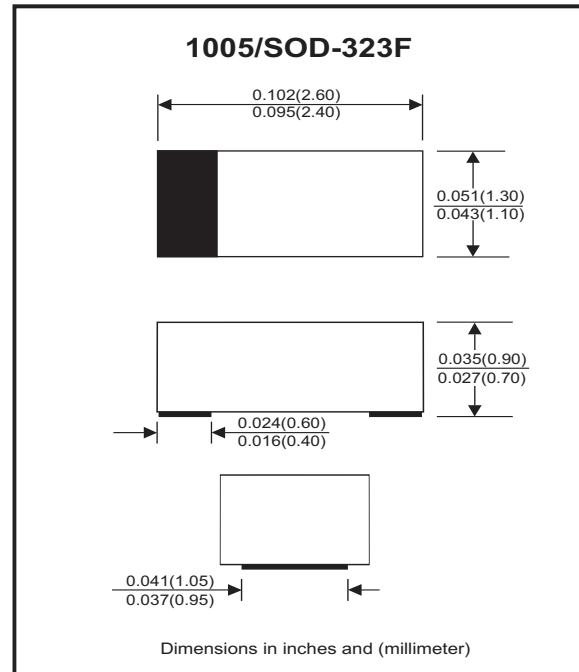

Circuit diagram



Maximum Rating (at $T_A=25^\circ\text{C}$ unless otherwise noted)

Parameter	Conditions	Symbol	Min	Typ	Max	Unit
Repetitive peak reverse voltage		V_{RRM}			100	V
Reverse voltage		V_R			80	V
Average forward rectified current		I_o			125	mA
Forward current, surge peak	$t = 1 \text{ us}$ $t = 8.3 \text{ ms}$	I_{FSM}			2 1	A
Power dissipation		P_D			350	mW
Junction temperature range		T_j	-40		+125	$^\circ\text{C}$
Storage temperature range		T_{STG}	-40		+125	$^\circ\text{C}$

Electrical Characteristics (at $T_A=25^\circ\text{C}$ unless otherwise noted)

Parameter	Conditions	Symbol	Min	Typ	Max	Unit
Forward voltage	$I_F = 5 \text{ mA}$ $I_F = 100 \text{ mA}$	V_F			0.72 1	V
Reverse current	$V_R = 20 \text{ V}$ $V_R = 80 \text{ V}$	I_R			25 100	nA
Capacitance between terminals	$f = 1 \text{ MHz}$, and 0.5 VDC reverse voltage	C_T			9	pF
Reverse recovery time	$I_F = I_R = 10 \text{ mA}$, $I_{rr} = 0.1 \times I_R$, $R_L = 100 \text{ ohm}$	T_{rr}			9	nS

RATING AND CHARACTERISTIC CURVES (CDSFR4448-HF)

Fig.1 - Forward Characteristics

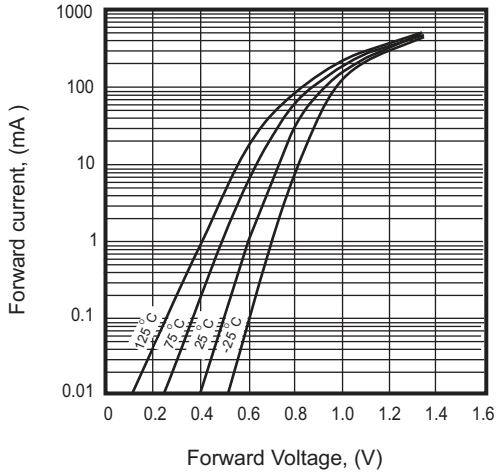

Fig.2 - Reverse characteristics

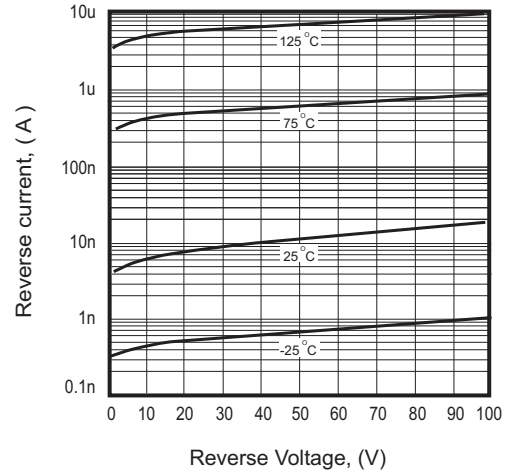

Fig.3 - Capacitance Between Terminals Characteristics

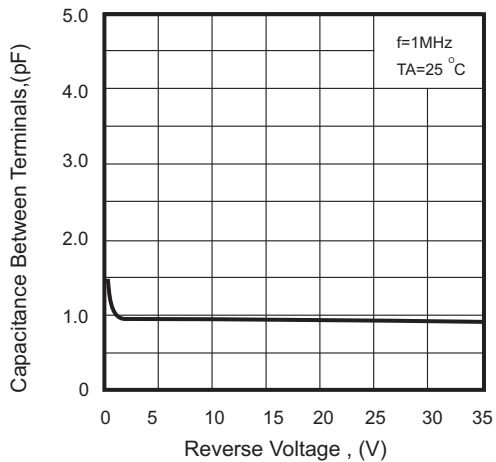
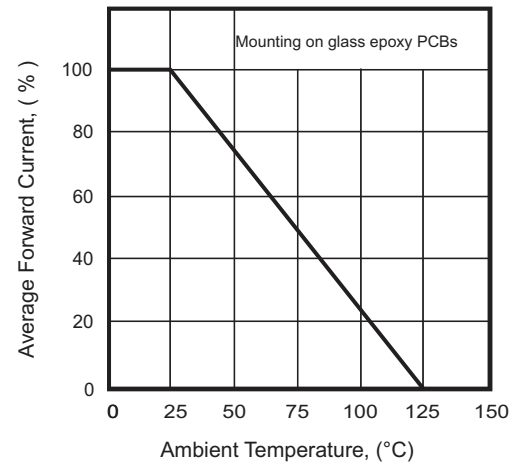
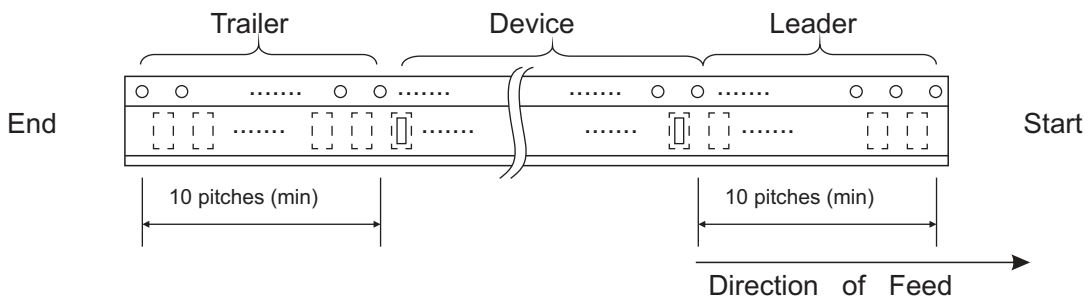
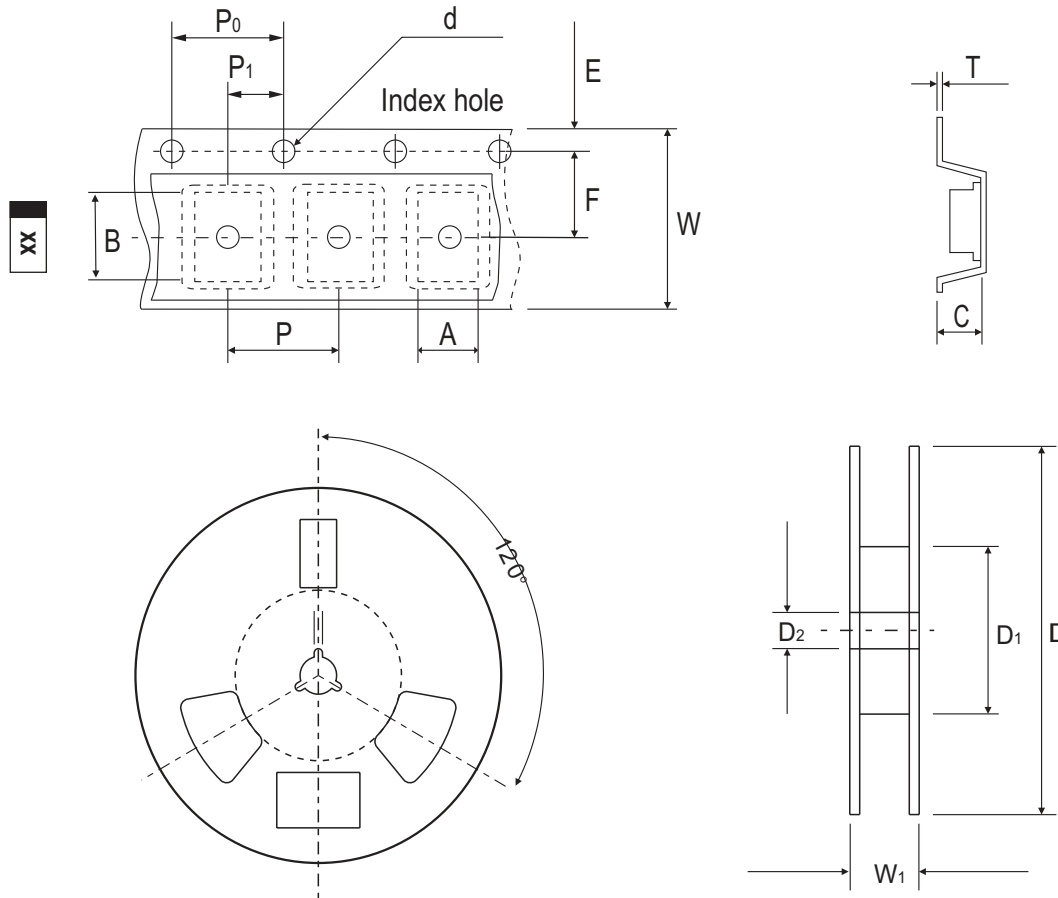

Fig.4 - Current Derating Curve



Reel Taping Specification



1005 (SOD-323F)	SYMBOL	A	B	C	d	D	D ₁	D ₂
	(mm)	1.55 ± 0.10	2.65 ± 0.10	1.05 ± 0.10	1.55 ± 0.05	178 ± 1	60.0 MIN.	13.0 ± 0.20
	(inch)	0.061 ± 0.004	0.104 ± 0.004	0.041 ± 0.004	0.061 ± 0.002	7.008 ± 0.04	2.362 MIN.	0.512 ± 0.008

1005 (SOD-323F)	SYMBOL	E	F	P	P ₀	P ₁	T	W	W ₁
	(mm)	1.75 ± 0.10	3.50 ± 0.05	4.00 ± 0.10	4.00 ± 0.10	2.00 ± 0.05	0.23 ± 0.05	8.00 ± 0.20	13.5 MAX.
	(inch)	0.069 ± 0.004	0.138 ± 0.002	0.157 ± 0.004	0.157 ± 0.004	0.079 ± 0.004	0.009 ± 0.002	0.315 ± 0.008	0.531 MAX.

Marking Code

Part Number	Marking Code
CDSFR4448-HF	S5



Suggested PAD Layout

SIZE	1005/SOD-323F	
	(mm)	(inch)
A	2.00	0.079
B	0.70	0.028
C	1.30	0.051
D	2.70	0.106
E	1.30	0.051

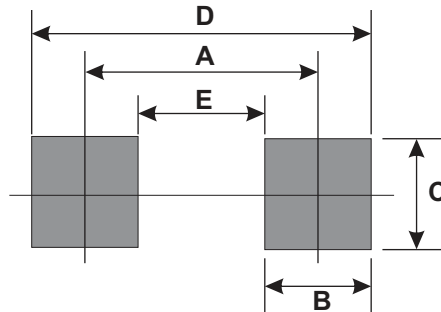

Standard Packaging

Case Type	REEL PACK	
	REEL (pcs)	Reel Size (inch)
1005/ SOD-323F	4,000	7