

MLX90381

Triaxis® Pico-Resolver
Datasheet

Features and Benefits

- Triaxis® Hall technology
- Sine and cosine analog outputs
- Output refresh rate 2 μ s
- 3.3V operating supply voltage
- Operating temperature range from -40°C to 160°C
- Selectable magnetic field Axis (X/Y - X/Z - Z/Y)
- Programmable sensitivity range
Mid field (10...70mT)
High field (40...160mT)
- End-of-Shaft / Through-Shaft operation
- Ratiometric outputs
- **ASIL READY** BY MELEXIS ISO26262 ASIL B safety element out of context
- AEC-Q100 qualified
- Onboard programming through I²C protocol
- DFN-6 single die RoHS compliant package



DFN-6 (LW)

Application Examples

- Absolute rotary position sensor
- Automotive and industrial applications
- E-valves
- E-bike motors
- Brushless motor control
- Permanent magnet synchronous motor
- Brushless DC motor (BLDC)

Description

The MLX90381, Triaxis® pico-resolver, is a monolithic contactless sensor IC sensitive to the flux density applied in three dimensions (X, Y, Z) to the IC. Two, selectable, axes can be mapped to the two high-speed analog outputs allowing the MLX90381 to be used for on-axis and off-axis (through-shaft) position sensing when paired with a moving permanent magnet. With its 3.3V supply, high speed, small size, and flexible configuration the MLX90381 is ideal for use in motor control applications when paired with a suitable microcontroller.

With a wide operating temperature and magnetic flux density range, the MLX90381 can resolve the angular position of a rotating axis over 360 degrees in many industrial and automotive applications. With a low response time and latency, the MLX90381 can measure rotational speeds of more than 50000 RPM.

Each axes' sensitivity and filter bandwidth can be programmed directly on board using I²C protocol through 2 application pins to tailor the output to the ADC input range of the companion MCU. No external programming tool is therefore needed.

The DFN-6 package (2.0mm x 2.5mm x 1.0mm), requiring only three external capacitors, minimizes PCB board area enabling compact designs. The MLX90381 is RoHS compliant with matte-tin plated, wettable flanks.



End-of-Shaft



Through Shaft

Ordering Information

Product	Temp.	Package	Option Code	Packing Form	Definition
MLX90381	G	LW	ACA-000	RE	Medium Field Version
MLX90381	G	LW	ACA-100	RE	High Field Version

Table 1 – Ordering codes

Legend:

Temperature Code:	G: from -40°C to 160°C
Package Code:	LW: for DFN-6 package
Option Code:	<p>AAA-123: Chip Revision</p> <ul style="list-style-type: none"> ▪ ACA: Production version <p>AAA-123: 1-Application - Magnetic Sensing Range</p> <ul style="list-style-type: none"> ▪ 0: Medium Field Version (70mT) ▪ 1: High Field Version (160mT) <p>23: Not used</p>
Packing Form:	RE: Tape and Reel (10000 pcs/reel) ⁽¹⁾
Ordering Example:	MLX90381GLW-ACA-000-RE for a Medium Field Version in DFN-6 package delivered in Reel

Table 2: Order codes description

¹ For engineering purposes, a reel of 500 parts or higher is possible on request. Contact your sales representative for more information.

Contents

Features and Benefits.....	1
Application Examples	1
Description	1
Ordering Information	2
1. Functional Diagram and Application Modes	5
2. Glossary of Terms.....	6
3. Pin Definitions and Descriptions	6
4. Absolute Maximum Ratings	7
5. General Description.....	8
6. Intrinsic Magnetic Axis.....	9
7. General Electrical Specifications	10
8. General Magnetic Specifications	11
8.1. Medium Field Sensing Range	13
8.2. High Field Sensing Range.....	14
8.3. Sensitivity Temperature Coefficient Characteristic	15
8.4. Output Offset Temperature Drift Characteristic.....	16
8.5. Signal Phase Shift vs. Magnetic Angular Speed	17
9. Programming Interface (I ² C)	18
9.1. I ² C unique slave circuit	18
9.2. Activate I ² C interface	18
9.3. I ² C Communication Protocol.....	19
9.3.1. Memory Read MTP & Register.....	19
9.3.2. Memory Write Register	19
9.3.3. Memory Write MTP	20
9.3.4. I ² C Timing Specification	20
10. End User Programmable Items	22
10.1. Memory Map Melexis Area.....	23
10.2. Memory Map End User Programmable Items	24
10.3. Memory Access Key Register	25
11. Descriptions of End User Programmable Items	27
11.1. Axis Selection: AXIS_CH1 - AXIS_CH2 - PLATEZ	27
11.2. Sensitivity Trimming	27
11.2.1. Rough Gain: RG_X - RG_Y - RG_Z.....	28

- 11.2.2. Fine Gain: FG_X - FG_Y - FG_Z 28
- 11.3. Voltage Output Quiescent: VOQ_OUT1 - VOQ_OUT2..... 28
- 11.4. Filter: FILT 29
- 11.5. Sensitivity Temperature Coefficient: TC..... 30
 - 11.5.1. TC..... 32
 - 11.5.2. TC350_DATA 32
 - 11.5.3. TC2000_DATA 32
- 11.6. Memory Lock 32
- 12. Functional Safety 33**
 - 12.1. Safety Manual 33
 - 12.2. Safety Mechanisms..... 33
- 13. Recommended Application Diagrams 35**
 - 13.1. MLX90381 in DFN-6 Package 35
- 14. Package Information..... 36**
 - 14.1. DFN-6 Package Dimensions and Sensitive Spot Location 36
 - 14.2. DFN-6 Pinout and Marking 36
- 15. Standard Information 37**
- 16. ESD Precautions..... 37**
- 17. Contact..... 37**
- 18. Disclaimer..... 38**

1. Functional Diagram and Application Modes

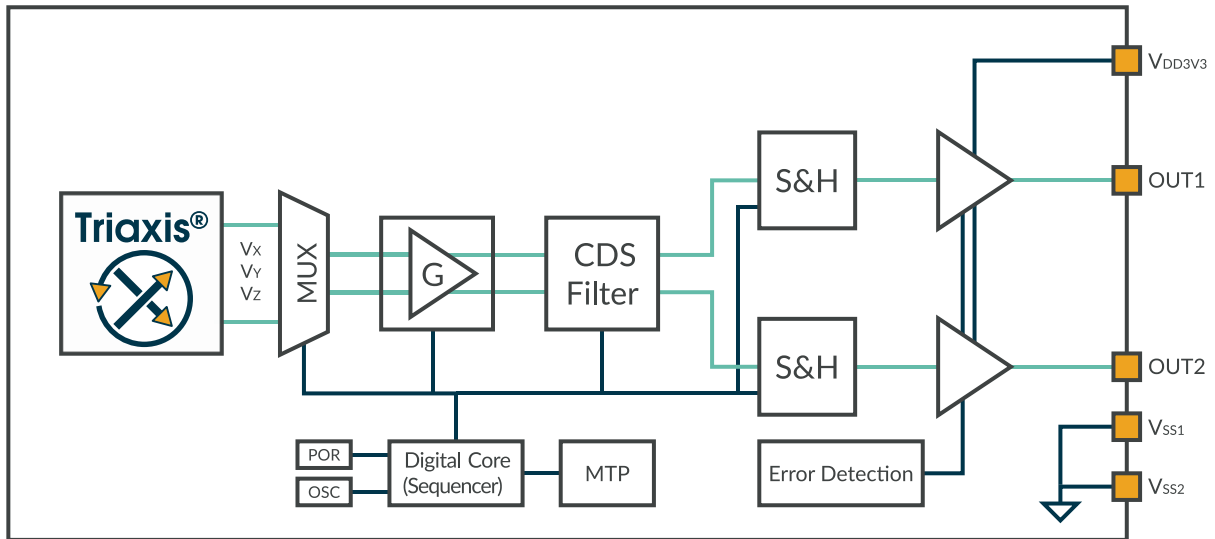
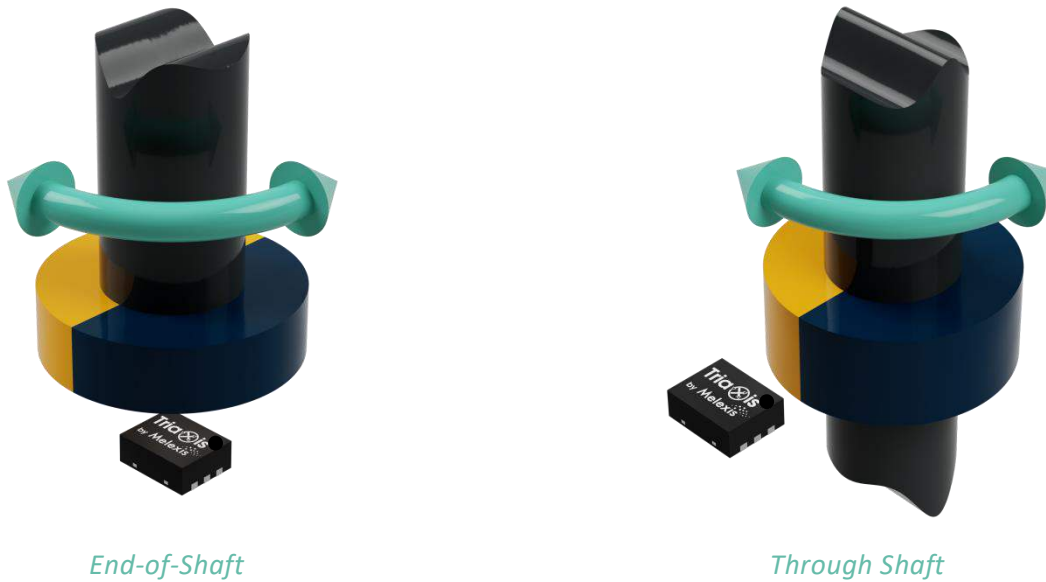

Figure 1 – Functional diagram



End-of-Shaft

Through Shaft

Figure 2 – Application modes

2. Glossary of Terms

Gauss (G), Tesla (T)	Units for the magnetic flux density 1 mT = 10 G	EoL	End of Line
TC	Temperature Coefficient (in ppm/°C.)	DAC	Digital to Analog Converter
NC	Not Connected	VOQ	Quiescent Offset Voltage
EMC	Electro-Magnetic Compatibility	RPM	Revolutions Per Minute (magnetic)
MTP	Multiple Time Programmable	MF	Medium Field Version
		HF	High Field Version

Table 3 – Glossary of terms

3. Pin Definitions and Descriptions

Pin#	Name	Description
1	VDD _{3V3}	Supply
2	VSS ₁	Ground
3	Test	Test Pin
4	VSS ₂	Ground
5	OUT1	Analog Output COS
6	OUT2	Analog Output SIN
EXP.	Not Connected	Exposed pad, can be connected to ground.

Table 4 – Pin definition

For optimal EMC behavior connect the test pin to the Ground. Important: VSS₁ and VSS₂ must both be grounded to guarantee the ASIL B level.

4. Absolute Maximum Ratings

Parameter	Symbol	Min.	Max.	Unit	Condition
Supply Voltage	VDD _{3V3}	-0.3	5.5	V	< 48h; T _J < 175°C
Negative Output Voltage	VOUT	-0.3	-	V	< 48h (OUT1, OUT2)
Positive Output Voltage	VOUT	-	VDD+0.3, 5V	V	< 48h (OUT1, OUT2)
Output Current	IOUT	-20	20	mA	
Operating Temperature Range	T _A	-40	160	°C	
Maximum Junction Temperature	T _J	-	175	°C	
Storage Temperature Range	T _S	-55	165	°C	
ESD Sensitivity					
Human Body Model	ESD _{HBM}	-	2	kV	AEC-Q100-002 Standard
Charged Device Model	ESD _{CDM}	-	500	V	AEC-Q100-011 Standard
Maximum Flux Density	B	-1	1	T	
Number of Write Cycles in MTP		-	20	Cycles	-40°C < T _A < 110°C

Table 5 – Absolute maximum ratings

Exceeding the absolute maximum ratings may cause permanent damage. Exposure to absolute maximum-rated conditions for extended periods may affect device reliability.

5. General Description

The MLX90381 is a monolithic sensor IC sensitive to the flux density applied orthogonally and parallel to the IC surface. High-speed dual analog outputs allow the MLX90381 to deliver accurate, contactless, true 360-degree sine & cosine signals when used with a rotating permanent magnet.

OUT1 and OUT2 output voltages are proportional to the applied magnetic field along 2 axes. Those 2 axes are specified by the parameters AXIS_CH1 and AXIS_CH2 (see section 11.1).

The MLX90381 is targeted for embedded application in the sense that the MCU and MLX90381 are located on the same PCB close to each other.

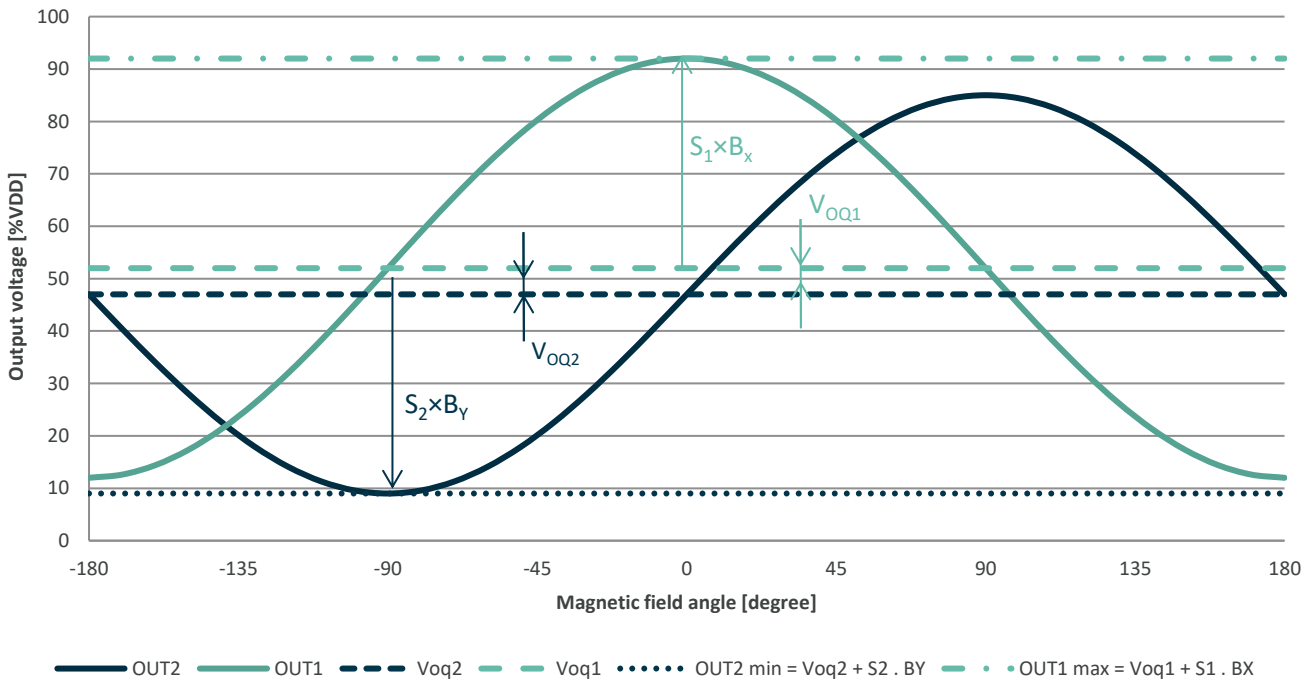

Figure 3 - Output characteristics

6. Intrinsic Magnetic Axis

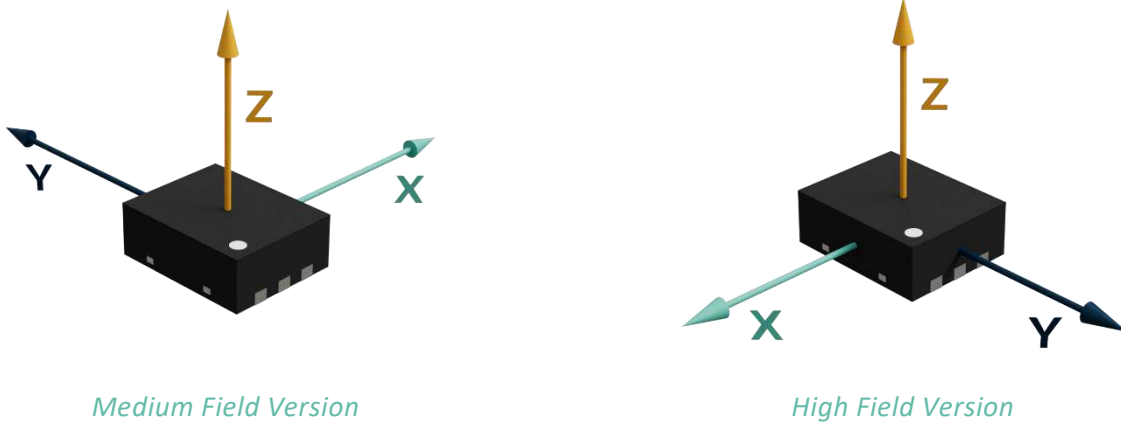

Figure 4 - Intrinsic magnetic axis

The MLX90381 is sensitive to the flux density applied in three dimensions (X, Y, Z) to the IC. Two selectable axes can be mapped to the two analog outputs. Figure 5 shows the position of the applied rotating field versus the selected axis X/Y, X/Z or Y/Z. The direction of the intrinsic magnetic axis of the High Field parts is inverted vs. the Mid Field parts.

- CW – Clockwise turn: The magnet needs to turn in the CW direction to get a positive slope of the angle calculated by an arctangent calculation (ATAN).
- CCW – Counterclockwise turn: The magnet needs to turn in the CCW direction to get a positive slope of the angle calculated by ATAN.

The CW - CCW rotation direction can be modified by changing the COS / SIN assignment to SIN / COS with an angle correction of 90 Deg.

$$\alpha = ATAN\left(\frac{SIN}{COS}\right)$$

The convention of preprogrammed parts is such that OUT2 is seen as SIN and OUT1 as COS.

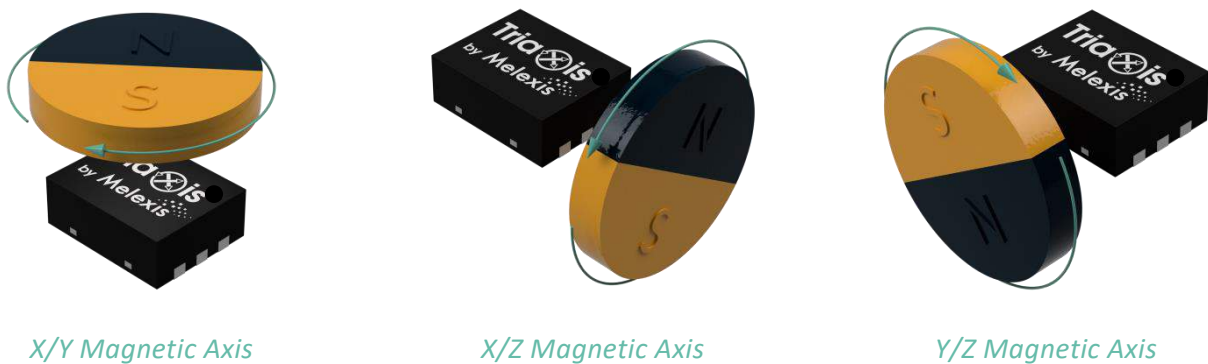

Figure 5 – Magnetic axis

7. General Electrical Specifications

General electrical specifications are valid for temperature range [-40; 160] °C and supply voltage range [3.1; 3.6] V unless otherwise noted.

Electrical Parameter	Symbol	Min.	Typ.	Max.	Unit	Condition
Supply Voltage	VDD _{3V3}	3.1	3.3	3.6	V	
Supply Current	IDD	3	4.2	5	mA	Excluding external load on OUT1&2
Power on Reset (POR) Voltage Rising	VPOR _{LH}	2.8	2.9	3.1	V	OUT HiZ → Operating mode
POR Voltage Hysteresis	HPOR _H	75	100	200	mV	
Load Current Range	IOUT	0.35 -0.65	0.45 -0.45	0.65 -0.35	mA	
Load Resistance Range ⁽²⁾	R _{L1,2}	50	110	∞	kΩ	Connected between OUT1,2 and GND
Load Capacitor Range	C _{L1,2}	0	1	2.2	nF	Connected between OUT1,2 and GND
Output Voltage Range	V _O	5 10	- -	95 90	%VDD	Linearity better than 1.5% Linearity better than 0.5%
Output Resistance	R _{OUT}	-	25	-	Ω	IOUT=±0.2mA
Power-On Time ⁽³⁾	τ _{ON}	-	400	800	μs	After VPOR _{LH}
Chopping Frequency	F _{CHOP}	1.8	2	2.2	MHz	
Output Update Period	τ _S	-	2	-	μs	Each field component takes 1μs, measured sequentially.
Output Noise Voltage ⁽⁴⁾	V _{nRMS}	-	-	5 10 15	mV	RMS noise, B=0mT, VDD=3.3V, S=1%VDD/mT for MF Version S=0.25%VDD/mT for HF Version Low bandwidth (FILT=31) Medium bandwidth (FILT=2) High bandwidth (FILT=0)
Nyquist Frequency	F _{nyq}	-	250	-	kHz	

² A pull-down resistor sets the output level when the output driver goes in HiZ mode after a diagnostic error is detected.

³ Lower bandwidth programming increases the Power-On Time with the increased tracking delay (see footnote 5).

⁴ Higher sensitivity programming may increase the output noise voltage. The peak-peak noise is 6σ or 6 V_{nRMS}. Verified by characterization, not production tested.

Electrical Parameter	Symbol	Min.	Typ.	Max.	Unit	Condition
Tracking Delay ⁽⁵⁾	τ_D	-	5	6.1	μs	High bandwidth (FILT=0)
		-	7	7.2		Medium bandwidth (FILT=2)
		-	33	40.5		Low bandwidth (FILT=31)
Over Current Detection	OCD	0.1 -0.6	0.45 -0.45	0.6 -0.1	mA	
Diagnostic Reporting Time ⁽⁶⁾	DRT	-	-	10	μs	Internal timing to set the diagnostic. ⁽⁷⁾
CRC diagnostic reporting time ⁽⁶⁾	DRT_CRC	-	-	1	ms	Internal timing to set the diagnostic. ⁽⁷⁾
Diagnostic Recovery Time ⁽⁶⁾		-	1	2.2	ms	
Diagnostic Output Level Low	Diag_lo	-	1	2	%VDD	Pull-down load $R_{L1,2} \geq 50\text{k}\Omega$
		-	1	5		Pull-down load $R_{L1,2} \geq 110\text{k}\Omega$
Diagnostic Output Level High	Diag_hi	98	99	-	%VDD	Pull-up load $R_{L1,2} \geq 50\text{k}\Omega$
		95	99	-		Pull-up load $R_{L1,2} \geq 110\text{k}\Omega$
Slave Address	I ² C_addr	-	0x32	-	7bit	Hard Coded Read 0x64 / Write 0x65 - 8bit address

Table 6 – General electrical specifications

8. General Magnetic Specifications

General electrical specifications are valid for temperature range [-40; 160] °C and supply voltage range [3.1; 3.6] V unless otherwise noted.

Magnetic Parameter	Symbol	Min.	Typ.	Max.	Unit	Condition
Magnetic Flux Density in Z	B _Z	-	-	160	mT	Programmable.
Sensitivity Temperature Coefficient ⁽⁸⁾	TC _S	-	350	-	ppm/°C	First Order approximation
		-	1100	-		SmCo
		-	2000	-		NdFeB Ferrite

⁵ Tracking Delay is defined as the time delay between a rotating magnetic stimulus and the change on both outputs, SIN and COS. This delay includes the sample and hold filter which can be programmed by the customer according to the equation listed in section 11.4. Guaranteed by design, not production tested.

⁶ Guaranteed by design and verified by characterization, not production tested.

⁷ Internal timing to set the diagnostic. The specification excludes the transition from HiZ to the diagnostic band, high or low, which is impacted by the capacitive and resistive load.

⁸ See section 8.3 for second order behavior.

Magnetic Parameter	Symbol	Min.	Typ.	Max.	Unit	Condition
Sensitivity Temperature Coefficient Drift	TC_{Sdrift}	-600 -600 -1000	- - -	1000 600 600	ppm/°C	Temperature drift around programmed TC_S $-40^{\circ}C \leq T_A \leq 35^{\circ}C$ $35^{\circ}C \leq T_A \leq 125^{\circ}C$ $35^{\circ}C \leq T_A \leq 160^{\circ}C$
Sensitivity Ratiometry Error	$\epsilon^R S$	-0.25	-	0.25	%	
Linearity ⁽¹⁰⁾	Lin	-1.5	-	1.5	%	Output voltage [5%VDD; 95%VDD]
Sensitivity Mismatch ⁽⁹⁾	S_{MISM}	-5	-	5	%	X vs. Y Valid for preprogrammed sensitivity by Melexis.
Output Offset Level	VOQ	47.5	50	52.5	%VDD	B=0mT, $T_A=35^{\circ}C$
Output Offset Ratiometry Error	$\epsilon^R VOQ$	-2.5	-	2.5	%	B=0mT (dVOQ/VOQ) - (dVDD/VDD) -10% < dVDD/VDD < 10%
Magnetic Angular Speed ⁽¹⁰⁾	RPM _{MAX}	0	-	>50000	RPM	Speed not limited by MLX sensor IC design. ⁽¹¹⁾ Electrical at Hall plates.
Signal Phase Shift ⁽¹⁰⁾	PHI	-	0.9	-	Degree	At 25000 RPM, high bandwidth programming
Output Update Rate ⁽¹⁰⁾	α_S	-	3.2	-	Sample/ Degree	At 25000 RPM, high bandwidth programming
Total Angular Error without Correction ⁽¹²⁾	NLE	-10 -15	- -	10 15	Degree	$T_A=35^{\circ}C$ $-40^{\circ}C \leq T_A \leq 160^{\circ}C$

Table 7 – Magnetic specifications

⁹ Sensitivity mismatch for the MLX factory EoL programmed sensitivity, see sensitivity parameter for MF or HF version.

¹⁰ Guaranteed by design and verified by characterization, not production tested.

¹¹ See section 8.5 Signal Phase Shift vs. Magnetic Angular Speed.

¹² Total angle error with an external homogeneous magnetic field stimulus. The system design (magnet eccentricity and sensor position) and manufacturing (assembly tolerances) may degrade the achieved accuracy.

8.1. Medium Field Sensing Range

General electrical specifications are valid for temperature range [-40; 160] °C and supply voltage range [3.1; 3.6] V unless otherwise noted.

Magnetic Parameter	Symbol	Min.	Typ.	Max.	Unit	Condition
Magnetic Flux Density in X-Y plane ⁽¹³⁾	B_x, B_y	-	-	70	mT	$\sqrt{B_x^2 + B_y^2}$ Programmable
Useful Magnetic Flux Density Norm	B_{Norm}	10	-	-	mT	$\sqrt{B_x^2 + B_y^2}$ (XY mode) $\sqrt{B_x^2 + \left(\frac{1}{G_{IMC}} B_z\right)^2}$ (XZ mode) $\sqrt{B_y^2 + \left(\frac{1}{G_{IMC}} B_z\right)^2}$ (YZ mode) see 11.1 for axis selection description.
IMC gain	G_{IMC}	-	1.04	-		with equal gain settings in MTP. ⁽¹⁴⁾
Sensitivity	S	-	1.33	-	%VDD/mT	30mT magnetic range for 80%VDD output range, see figure 3. (Default MTP content). See section 11.2 to modify this parameter.
Sensitivity Accuracy ⁽¹⁵⁾	ϵ_S	-8 -10	- -	8 10	%	$T_A=35^\circ\text{C}$, $VDD=VDDNOM$, $S=1.33\%VDD/mT$ XY - magnetic axis Z - magnetic axis
Output Offset Temperature Drift ^{(12) (16)}	$\epsilon^T VOQ$	-0.011 -0.015 -0.018	- - -	0.011 0.015 0.018	%VDD/°C	$B=0mT$, $S=1.33\%VDD/mT$ $-40^\circ\text{C} \leq T_A \leq 125^\circ\text{C}$ vs. 35°C XY - magnetic axis Z - magnetic axis $125^\circ\text{C} \leq T_A \leq 160^\circ\text{C}$ vs. 35°C XYZ - magnetic axis
Total Angular Error with Dynamic Compensation ⁽¹⁷⁾		-1 -1	- -	1 1	Degree	XY - magnetic axis XZ/YZ - magnetic axis

Table 8 – Magnetic specifications medium field sensing range

¹³ Guaranteed by design and verified by characterization, not production tested.

¹⁴ A correction factor, called IMC gain has to be applied to the Z field component to account for this difference.

¹⁵ Sensitivity accuracy for the MLX factory programmed sensitivity, see sensitivity parameter for MF or HF version. The sensitivity accuracy can be improved by EoL trimming of the sensitivity after the assembly of the module.

¹⁶ See section 8.4 for the full Output Offset Temperature Drift Characteristics.

¹⁷ The Total Angular Error with Dynamic Compensation is the residual angle error after the signal processing by the embedded microcontroller. The total angular error is reduced dynamically (continuous compensation) via signal I monitoring during the off-chip signal processing performing the angular computation. Offset, amplitude and phase corrections of the output signals must be applied. The total angle error refers only to the linearity error associated to the MLX90381. The angle linearity error associated to the magnetic and mechanical design is not included and should be considered as an additional contribution.

8.2. High Field Sensing Range

General electrical specifications are valid for temperature range [-40; 160] °C and supply voltage range [3.1; 3.6] V unless otherwise noted.

Magnetic Parameter	Symbol	Min.	Typ.	Max.	Unit	Condition
Magnetic Flux Density in X-Y plane ⁽¹⁸⁾	B _x , B _y	-	-	160	mT	$\sqrt{B_x^2 + B_y^2}$ Programmable
Useful Magnetic Flux Density Norm	B _{Norm}	40	-	-	mT	$\sqrt{B_x^2 + B_y^2}$ (XY mode) $\sqrt{B_x^2 + \left(\frac{1}{G_{IMC}} B_z\right)^2}$ (XZ mode) $\sqrt{B_y^2 + \left(\frac{1}{G_{IMC}} B_z\right)^2}$ (YZ mode) see 11.1 for axis selection description.
IMC gain	G _{IMC}	-	0.25	-		With equal gain settings in MTP. ⁽¹⁹⁾
Sensitivity	S	-	0.67	-	%VDD/mT	60mT magnetic range for 80%VDD output range, see figure 3. (Default MTP content). See section 11.2 to modify this parameter.
Sensitivity Accuracy ⁽²⁰⁾	εS	-8 -10	- -	8 10	%	T _A =35°C, VDD=VDDNOM, S=0.67%VDD/mT XY - magnetic axis Z magnetic axis
Output Offset Temperature Drift ^{(17) (21)}	ε ^T VOQ	-0.02 -0.046	- -	0.02 0.046	%VDD/°C	B=0mT, S=0.67 %VDD/mT -40°C ≤ T _A ≤ 125°C vs. 35°C XYZ - magnetic axis 125°C ≤ T _A ≤ 160°C vs. 35°C XYZ - magnetic axis
Total Angular Error with Dynamic Compensation ⁽²²⁾		-1 -2	- -	1 2	Degree	XY - magnetic axis XZ/YZ - magnetic axis

Table 9 – Magnetic specifications high field sensing range

¹⁸ Guaranteed by design and verified by characterization, not production tested.

¹⁹ A correction factor, called IMC gain has to be applied to the Z field component to account for this difference.

²⁰ Sensitivity accuracy for the MLX factory programmed sensitivity, see sensitivity parameter for MF or HF version. The sensitivity accuracy can be improved by EoL trimming of the sensitivity after the assembly of the module.

²¹ See section 8.4 for the full Output Offset Temperature Drift Characteristics.

²² The Total Angular Error with Dynamic Compensation is the residual angle error after the signal processing by the embedded microcontroller. The total angular error is reduced dynamically (continuous compensation) via signal monitoring during the off-chip signal processing performing the angular computation. Offset, amplitude and phase corrections of the output signals must be applied. The total angle error refers only to the linearity error associated to the MLX90381. The angle linearity error associated to the magnetic and mechanical design is not included and should be considered as an additional contribution.

8.3. Sensitivity Temperature Coefficient Characteristic

The sensitivity temperature coefficient of the MLX90381 is a first order sensitivity compensation to counter the degradation of the magnet's field strength over temperature. The TC_S is foreseen with a target TC_S of SmCo, NdFeB and Ferrite. The actual TC_S of the sensor will show a small non-linearity versus the ideal TC_S as illustrated in the figure below. The reference temperature for the TC_S plotted below is 35°C. The characteristic can be used to get a view of the amplitude/span modulation of the sensor's outputs over temperature. The TC_S plotted below is made from characterization data of a small population of samples and is indicative.

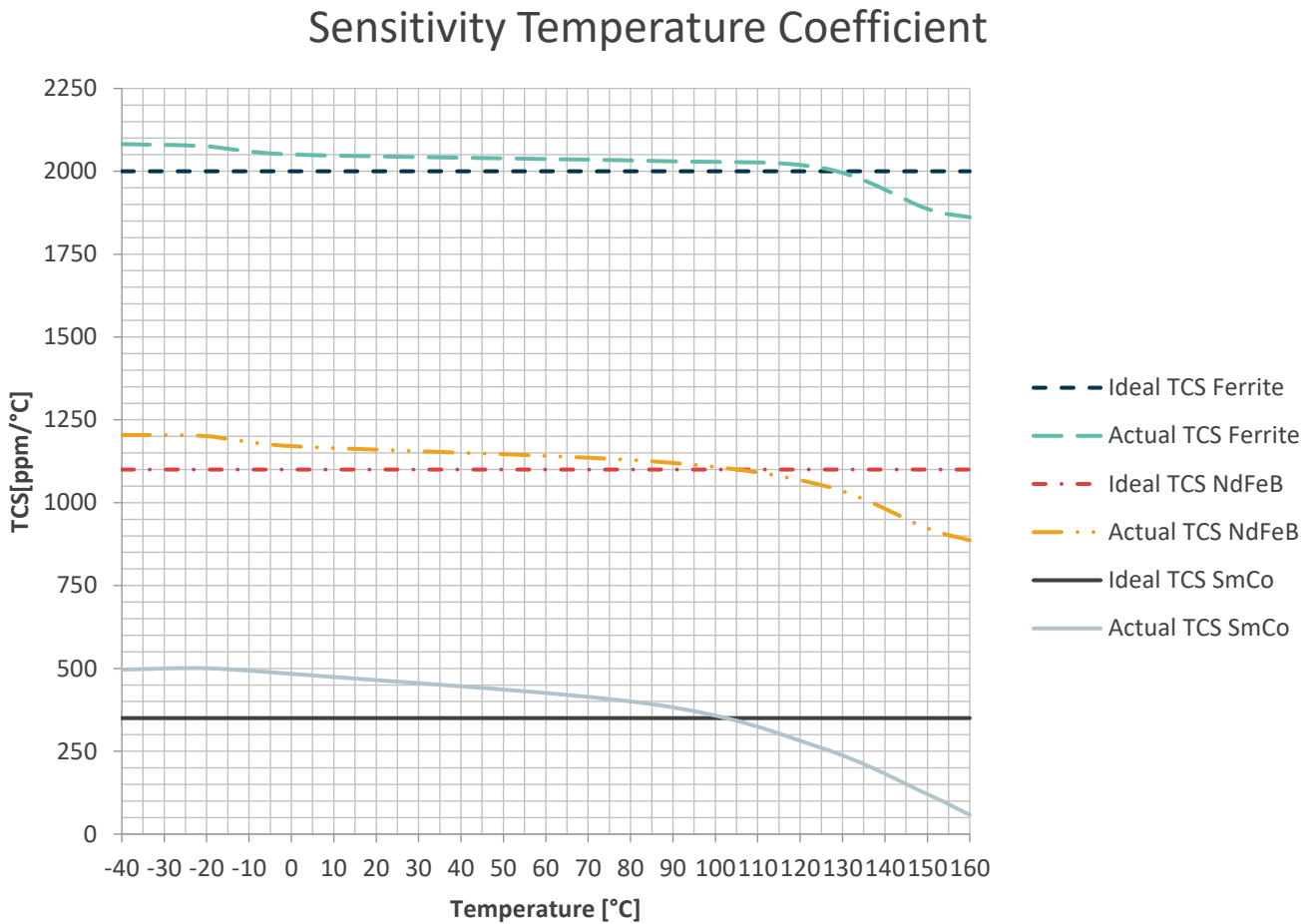

Figure 6 – Target TCS vs. 2nd order TCS

8.4. Output Offset Temperature Drift Characteristic

In the Magnetic Specifications, the Output Offset Temperature Drift of the MLX90381 is specified for $B=0mT$, $VDD=VDDNOM$, $-40^{\circ}C \leq T \leq 125^{\circ}C$ and $125^{\circ}C \leq T \leq 160^{\circ}C$. The chart in Figure 7 list the typical Output Offset Temperature Drift characteristics for the full magnetic range for $T_A = 125^{\circ}C$ and $160^{\circ}C$. The Output Offset Temperature Drift is calculated from $35^{\circ}C$ to T_A . The Output Offset Temperature Drift plotted in Figure 7 is made from characterization data of a small population of samples and is indicative.

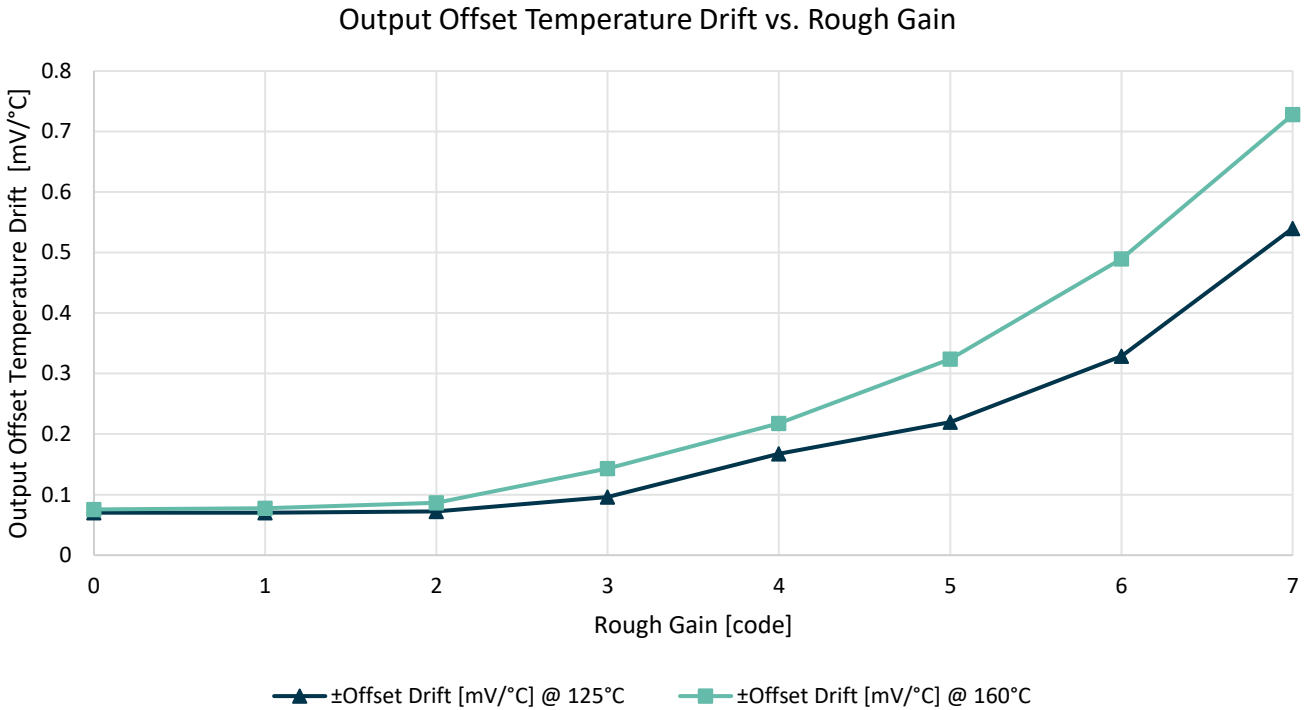

Figure 7 – Output offset temperature drift vs. rough gain

8.5. Signal Phase Shift vs. Magnetic Angular Speed

The magnetic angular speed of the Melexis sensor IC is not limited by its electrical design. The magnetic angular speed of the application has however an impact on the signal phase shift and the output update rate in samples/degree rotation.

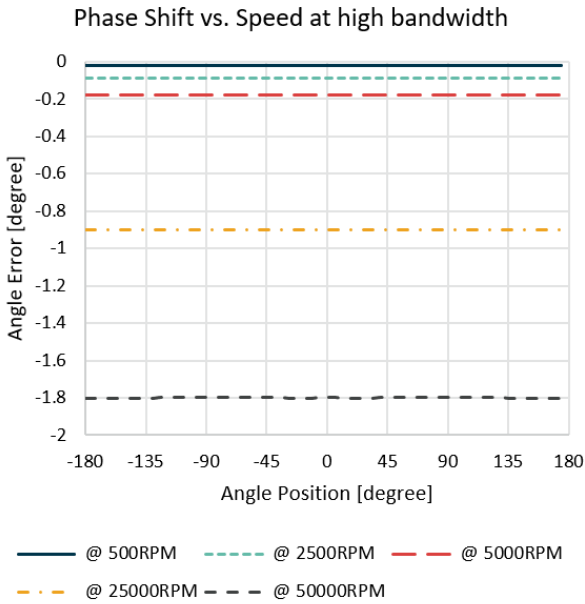

Figure 8 - Signal phase shift vs. magnetic angular speed

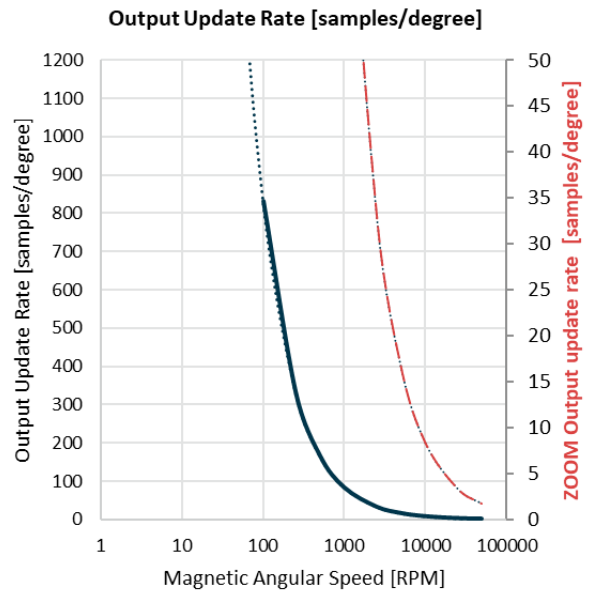

Figure 9 – Output update rate vs. magnetic angular speed

9. Programming Interface (I²C)

9.1. I²C unique slave circuit

The MLX90381 is customer EoL (End of Line) programmable (limited to customer memory area) through the OUT1 and OUT2 pins of the sensor. The communication protocol is derived from I²C (100kHz standard speed). The I²C SCL and SDA pins are shared with normal application pins OUT1 and OUT2. The double function of the output pins makes the MLX90381 a unique slave in the circuitry.

9.2. Activate I²C interface

The Activation sequence of the I²C interface resembles an addressing write cycle to I²C address 0x00.

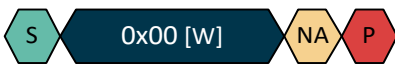

The differences are found in the start bit which requires a delay to allow the output drivers of the MLX90381 sensor to switch off and turn to listening mode. Secondly, the Acknowledge of the slave to the master which is a high acknowledge and not a low acknowledge.

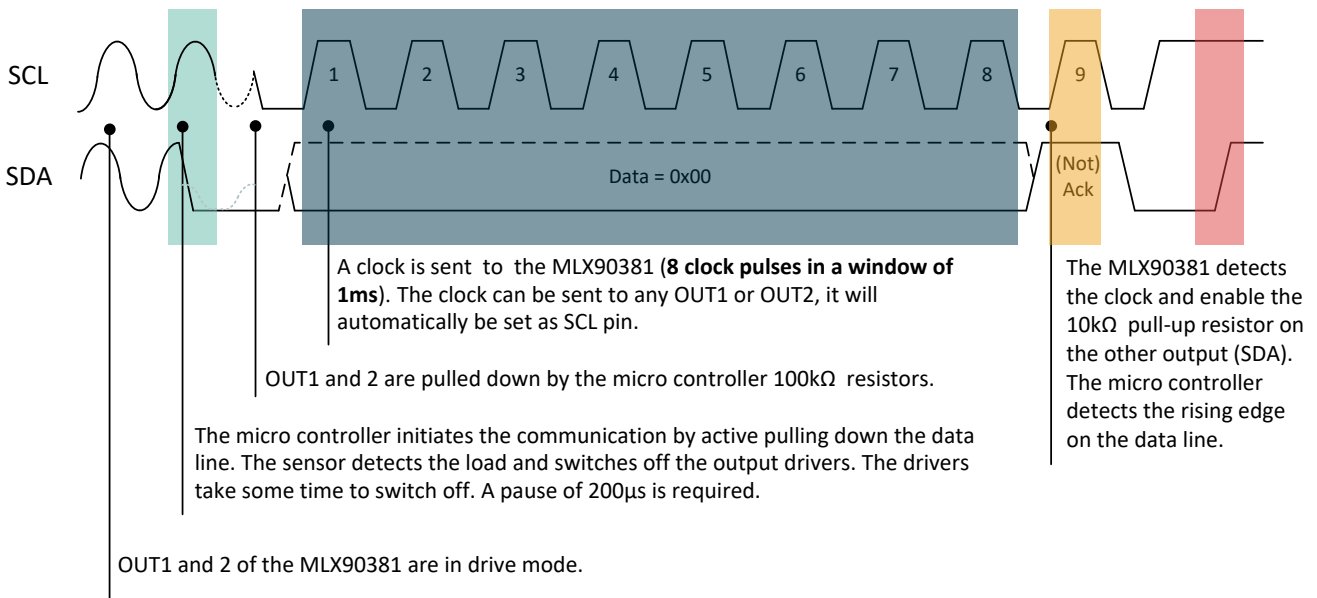

Figure 10 – Activation I²C interface

The I²C activation mechanism uses the overcurrent diagnostic failure detection circuit to switch the drivers OUT1 & OUT2 in High-Z. To switch off the output drivers the sensor needs to detect an overcurrent (see parameter “Over Current Detection OCD” in the section 7 “General Electrical Specifications”). There is a de-bounce time on the overcurrent detection. Note that the communication can be enabled by a pulling up instead of pulling down (the overcurrent detection works in both sink and source direction).

At least 8 SCL pulses have to be sent to activate I²C interface. Once I²C is activated the internal 10kΩ pull-up resistor is enabled on the I²C data bus.

There is an I²C Bus Timeout in case there is no I²C communication after activation. Upon timeout the sensor returns to application mode. The MTP memory lock has no influence on this timeout.

9.3. I²C Communication Protocol

The MLX90381 sensor uses an I²C derived communication interface to read/write Customer configuration register as well as Customer MTP area. The I²C communication protocol with the MLX90381 consists out of three basic communication commands to read and write the memory of the sensor. The MLX90381 is a pure I²C slave. The slave address, I²C_addr, is hard coded; (see section 7 “General Electrical Specifications”).

Legend:

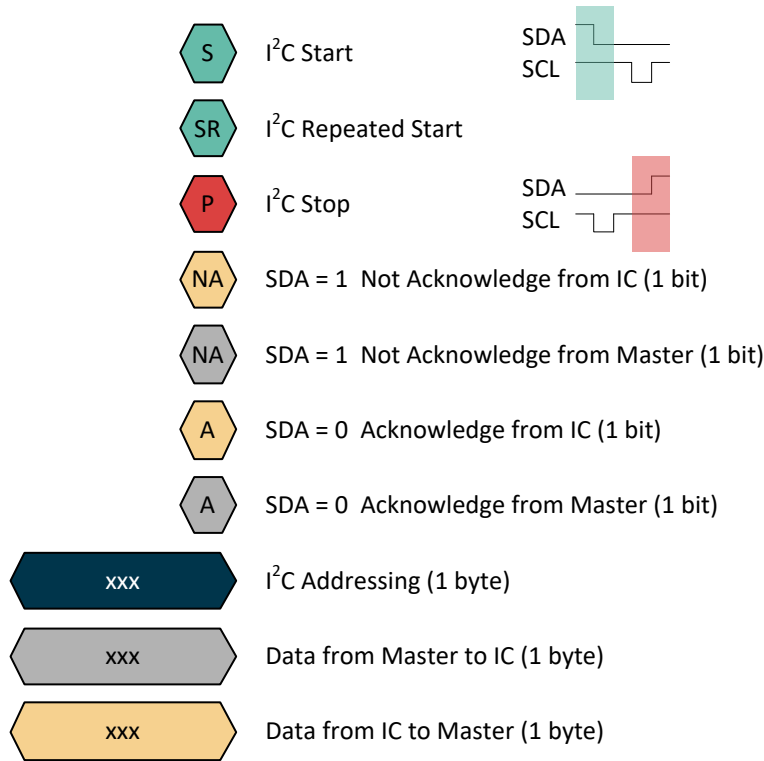

Figure 11 - Legend

9.3.1. Memory Read MTP & Register

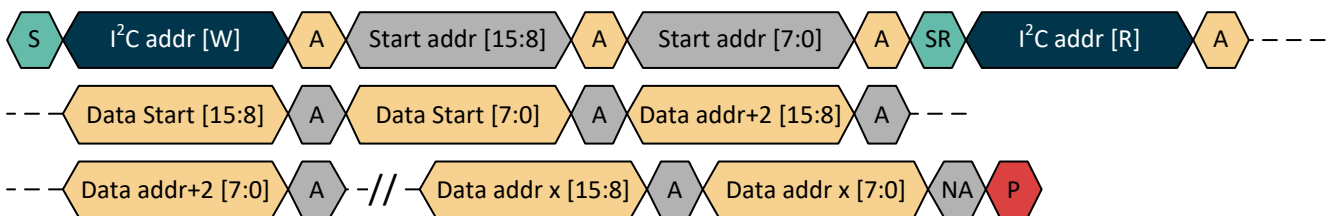

Figure 12 - Memory read MTP & register

9.3.2. Memory Write Register

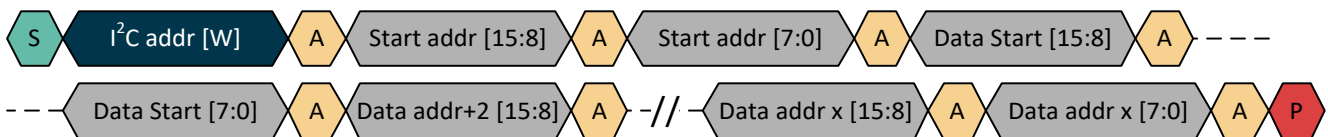

Figure 13 - Memory write register

9.3.3. Memory Write MTP

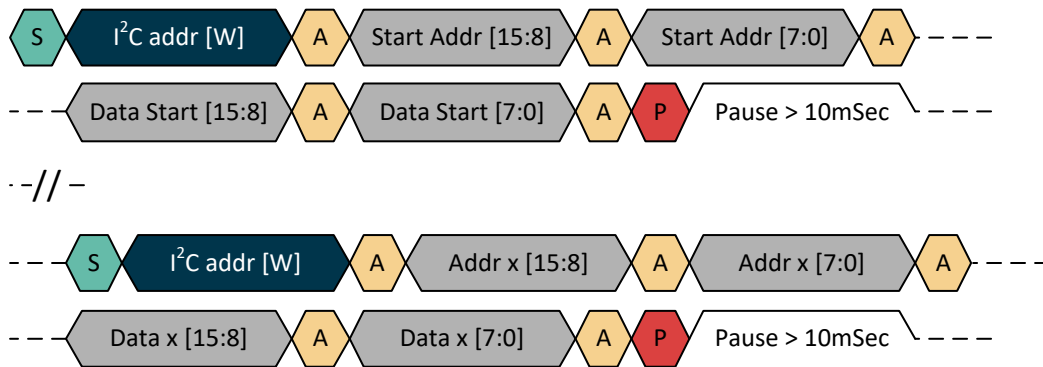

Figure 14 - Memory write MTP

The MTP has a limited allowed write cycles for a charge time of 10 to 11 milliseconds. There is no counter in the sensor on the number of write cycles performed on the MTP. For an optimal lifetime performance of the MTP, it is mandatory to limit the write cycles to a single cell to only a few times. See parameter “Number of Write Cycle in MTP” in Section 4 “Absolute Maximum Ratings”.

The I²C master has to release the I²C bus within 1 SCL period, I²C Bus Release Time, after sending stop bit of the last frame before switching in normal application mode. This is needed to avoid that both the I²C master and the MLX90381 are driving the I²C bus when the sensor switches on the output drivers.

9.3.4. I²C Timing Specification

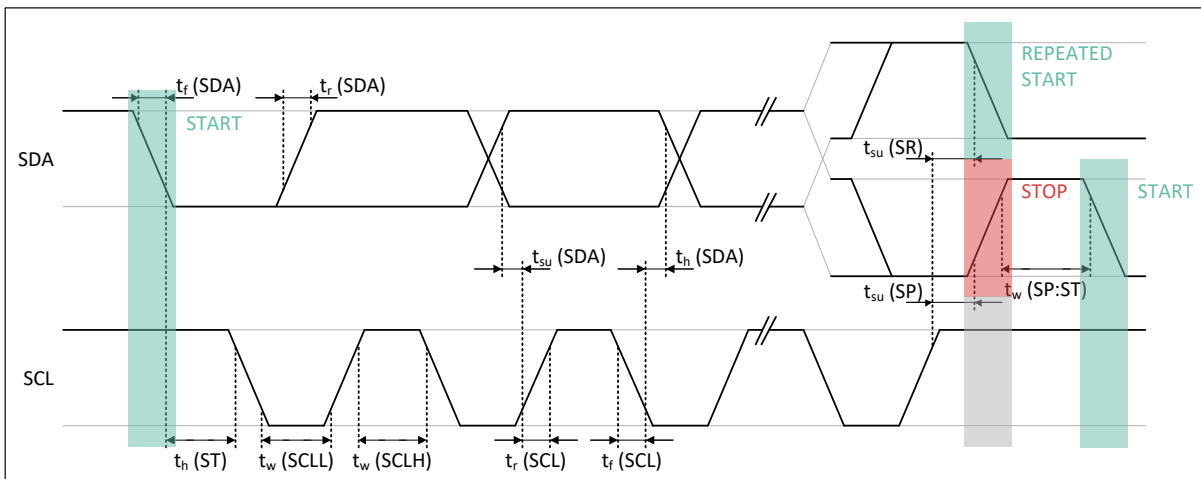

Figure 15 – I²C timing diagram

Electrical Parameter ⁽²³⁾	Symbol	I ² C Standard Mode			Unit
		Min.	Typ.	Max.	
SCL Clock Frequency ²⁴	f (SPC)	-	-	100	kHz
SCL Clock Low Time	tw (SCLL)	4.7	-	-	μs
SCL Clock High Time	tw (SCLH)	4	-	-	μs
SDA Setup Time	tsu (SDA)	250	-	-	ns
SDA Data Hold Time	th (SDA)	-	-	3.45	μs
SDA and SCL Rise Time	tr (SDA)	-	-	1000	ns
	tr (SCL)				
SDA and SCL Fall Time	tf (SDA)	-	-	300	ns
	tf (SCL)				
START Condition Hold Time	th (ST)	4	-	-	μs
REPEATED START Condition Setup Time	tsu (SR)	4.7	-	-	μs
STOP Condition Setup Time	tsu (SP)	4	-	-	μs
Bus Free Time Between STOP and START Condition	tw (SP:ST)	4.7	-	-	μs
Activation De-Bounce Time (OUTPUT OC)		4	5	-	μs
I ² C Bus Timeout		20	30	-	ms
I ² C Bus Release Time (1 SCL period at 100kHz standard speed)		-	10	-	μs

Table 10: General I²C timing specification

²³ Guaranteed by design and verified by characterization, not production tested. Parameters valid for 25°C.

²⁴ SCL Clock Frequency needs to be adapted to the capacitors on the output pins.

10. End User Programmable Items

The MLX90381 sensor has a volatile memory - the operating register - and a non-volatile memory to store the configuration of the sensor. The volatile and non-volatile memories can be written via I²C commands. To gain access to the memory a key need to be written in the access key register. I²C write access outside customer configuration registers or customer MTP area addresses is automatically rejected.

Unused bits in the MTP have to stay programmed = 0. For the Registers failure detection (CRC), the unused cells are considered = 0. If the data in unused cells is $\neq 0$, this Safety mechanism will flag an error on the Registers failure detection (CRC).

Changing the contend of unused bits to $\neq 0$ will result in disabling the functionality of the sensor permanently!

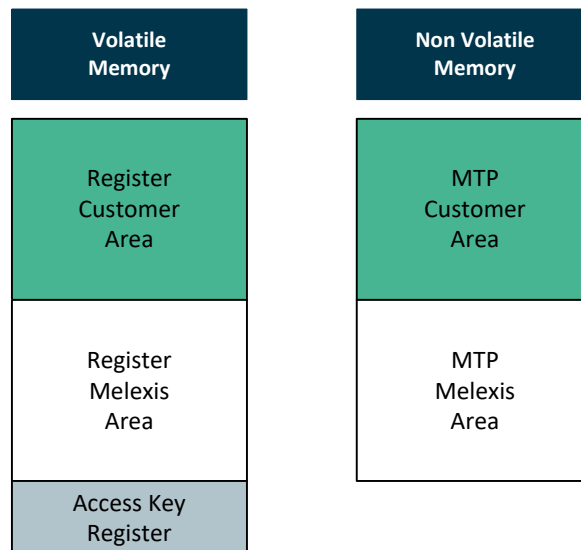

Figure 16 – Customer configuration register and MTP

10.1. Memory Map Melexis Area

Address			Word [2 bytes]							
Register [HEX]	MTP [HEX]	Byte	7	6	5	4	3	2	1	0
0x34	0x14	LSB	RESERVED [7:0]							
		MSB	TC2000_DATA [3:0] ⁽²⁵⁾				RESERVED [12:8]			
0x3A	0x1A	LSB	Chip_ID1 [7:0]							
		MSB	Chip_ID1 [15:8]							
0x3C	0x1C	LSB	Chip_ID2 [7:0]							
		MSB	Chip_ID2 [15:8]							
0x3E	0x1E	LSB	Chip_ID3 [7:0]							
		MSB	Chip_ID3 [15:8]							

Table 11 – Register/MTP table Melexis area which is read only

²⁵ TC information bits for Ferrite Magnets. These bits are not used by the sensor. But the data can be used to change the TC parameter of the sensor.

10.2. Memory Map End User Programmable Items

Address			Word [2 bytes]								
Register [HEX]	MTP [HEX]	Byte	7	6	5	4	3	2	1	0	
0x20	0x00	LSB	FG_X [4:0]				RG_X [2:0]				
		MSB	0x0 ⁽²⁶⁾				VOQ_OUT1 [3:0]				
0x22	0x02	LSB	FG_Y [4:0]				RG_Y [2:0]				
		MSB	0x0				VOQ_OUT2 [3:0]				
0x24	0x04	LSB	FG_Z [4:0]				RG_Z [2:0]				
		MSB	0x00								
0x26	0x06	LSB	0x0	PLATEZ [1:0]		AXIS_CH2 [1:0]		AXIS_CH1 [1:0]			
		MSB	0x00								
0x28	0x08	LSB	0x0		TC [4:0]						
		MSB	0x00								
0x2A	0x0A	LSB	0x0		FILT [4:0]						
		MSB	0x00								
0x2C	0x0C	LSB	0x00						DIS_DIAGS ⁽²⁷⁾		MEMLOCK
		MSB	0x00								
0x2E	0x0E	LSB	0x0				TC350_DATA [3:0] ⁽²⁸⁾				
		MSB	0x00								

Table 12 – Register/MTP table customer area

²⁶ Bits in the MTP marked with 0x0 or 0x00 have to stay programmed equal to 0!

²⁷ DIS_DIAG = 0: Disable Diagnostics should be set to 0 in normal application mode for ASIL applications.

²⁸ TC information bits for SmCo Magnets. These bits are not used by the sensor. But the data can be used to change the TC parameter of the sensor.

10.3. Memory Access Key Register

The first access key register is called I²C_cmd register with address 0x44 which gives Calibration Mode Access:

- Write 0x544E in the I²C_cmd register to allow entering calibration mode;
- Write 0x944C in the I²C_cmd register to allow starting SIN/COS generation in normal application mode;
- Write 0x744C in the I²C_cmd register to allow starting SIN/COS generation in calibration mode;
- Other written content will reset calibration mode.

The second access key register is called ee_shell_ctrl register with address 0x46 which provides MTP Read/Write Access:

- Write 0x0077 in the ee_shell_ctrl register to get out of MTP standby mode and enter MTP write mode;
- Write 0x0007 in the ee_shell_ctrl register to get out of MTP standby mode and enter MTP read mode;
- Write 0x0006 in the ee_shell_ctrl register to deactivate MTP and reset write mode. After that, the chip automatically goes to application by resetting calibration mode. Thus, data from MTP are copied to configuration register;
- The MLX90381 must be in Calibration Mode to be able to get MTP Read/Write Access.

The following example flow chart shows which access key('s) to write in the memory access key register to:

- Load Sensor Output characteristics in registers and verify output
- Program Sensor Output characteristics in MTP and verify output
- Read MTP
- Program LOCK MTP

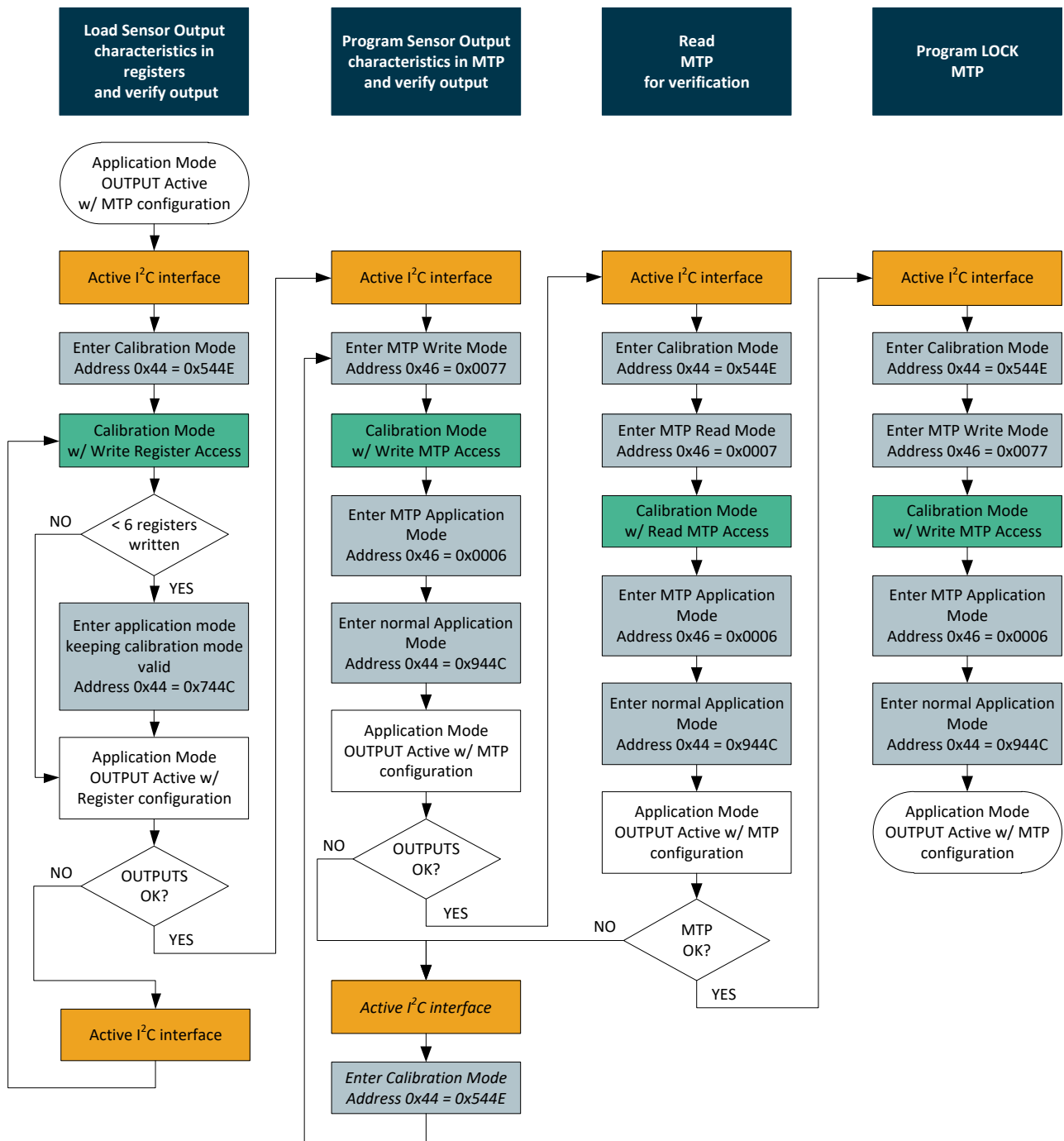

Figure 17 - Example flow for memory access key register

11. Descriptions of End User Programmable Items

11.1. Axis Selection: AXIS_CH1- AXIS_CH2- PLATEZ

The parameters AXIS_CH1 and AXIS_CH2 specify which magnetic axis is reported to OUT1 (CH1) and OUT2 (CH2). The selection of the magnetic axis is determined by the position of the sensor versus the magnet, as illustrated in the section 6 Intrinsic Magnetic Axis. The parameter PLATEZ selects which plates are used to measure the magnetic field on the Z-axis.

The table below summarizes how to program the parameters AXIS_CH1, AXIS_CH2 and PLATEZ based on the application.

Magnetic axes OUT1/OUT2	OUT1	OUT2	PLATEZ	AXIS_CH2	AXIS_CH1	Address 0x26 – 0x06
X/Y	X-axis	Y-axis	0	1	0	0x04
Y/X	Y-axis	X-axis	0	0	1	0x01
X/Z	X-axis	Z-axis	2	2	0	0x28
Z/X	Z-axis	X-axis	2	0	2	0x22
Y/Z	Y-axis	Z-axis	1	2	1	0x19
Z/Y	Z-axis	Y-axis	1	1	2	0x16

Table 13 – AXIS_CH1 - AXIS_CH2 - PLATEZ vs. axis selection

11.2. Sensitivity Trimming

The MLX90381 allows modifying the sensitivity described in sections 8.1 and 8.2 through the use the Rough Gain and Fine Gain parameters.

The calculation of the required sensitivity is done on the applied magnetic field versus the desired output span. The output span must have a guard band versus the output driver upper (VDD) and lower (VSS) rail to cover the application embedded processors diagnostic band, the sensors and module temperature behavior and the module operational tolerances. The output span may not exceed 80%VDD at 25°C and 90%VDD over the full temperature range for an upper and lower diagnostic band of 5%VDD, 5%VDD < OUT < 95%VDD. See Fail-safe states specification in the MLX90381 Safety Manual.

11.2.1. Rough Gain: RG_X- RG_Y- RG_Z

With the Rough Gain of the sensor the sensitivity range of the Variable Gain Amplifier can be modified in 8 steps. The table below lists the typical ratios on the Rough Gain.

RG [LSB]	X- Y-axis MF	Z-axis MF	X- Y-axis HF	Z-axis HF
0	5.7	5.5	1.6	6.3
1	10.1	9.7	2.8	11.2
2	15.7	15.2	4.3	17.6
3	22.6	21.9	6.2	25.3
4	31.5	30.5	8.7	35.2
5	53.2	51.4	14.6	59.4
6	75.2	72.7	20.6	83.7
7	123.6	119.4	33.8	137.5

Table 14 – Ratio rough gain

11.2.2. Fine Gain: FG_X- FG_Y- FG_Z

The Fine Gain is an additional attenuation of 0.5

- FG code 0 lowers/attenuates the gain by 0.5
- FG code 31 leads to a gain of 1.

In between is a linear interpolation over the fine gain steps.

The FG code for a Fine Gain or FG correction can be calculated with the following formula:

$$FG\ MTP\ code = \frac{(FG\ correction - 0.5) \times 31}{0.5}$$

The Fine Gain for an FG code can be calculated with the following formula:

$$Fine\ Gain = \frac{FG\ MTP\ code \times 0.5}{31} + 0.5$$

11.3. Voltage Output Quiescent: VOQ_OUT1- VOQ_OUT2

The VOQ level is the reference level (generated by a DAC) of the output amplifiers (differential amplifiers). It is proportional to the external supply voltage VDD and adjustable in a limited range around VDD/2. The level can be adjusted by 4 bits with a typical resolution ±20mV. The typical adjustment range is ±140mV.

11.4. Filter: FILT

Tracking Delay is defined as the time delay between a rotating magnetic stimulus and the change on both outputs, SIN and COS. This delay includes the sample and hold filter delay. The filter can be programmed with the parameter FILT according to the following equation:

$$V_o = \frac{V_i}{n} + V_o(Z^{-1}) \frac{1}{(1-n)}$$

The bandwidth is:

$$B = 1/(\pi (2n - 1) \tau_s)$$

“n” denotes the capacitors of the low-pass filter. n=1.5, 2, 2.5... 17 (5 bits) as a ratio.

Output Update Period τ_s is defined in the General Electrical Specifications.

The table below lists the theoretical bandwidth of the filter with Low, Medium and High Bandwidth.

Bandwidth	FILT [LSB]	n	B [Hz]	Bandwidth	FILT [LSB]	n	B [Hz]	
High	0	1.5	79576		16	9.5	8842	
	1	2	53050		17	10	8376	
Medium	2	2.5	39788		18	10.5	7958	
	3	3	31830		19	11	7578	
	4	3.5	26524		20	11.5	7234	
	5	4	22736		21	12	6918	
	6	4.5	19894		22	12.5	6630	
	7	5	17682		23	13	6366	
	8	5.5	15914		24	13.5	6122	
	9	6	14468		25	14	5894	
	10	6.5	13262		26	14.5	5684	
	11	7	12242		27	15	5488	
	12	7.5	11368		28	15.5	5304	
	13	8	10610		29	16	5134	
	14	8.5	9946		30	16.5	4972	
	15	9	9362		Low - Default	31	17	4822

Table 15 – Filters

11.5. Sensitivity Temperature Coefficient: TC

TC [bin]	TC [signed]	TC _s [ppm/°C]	TC [bin]	TC [signed]	TC _s [ppm/°C]
00000	0	800	10000	0	800
00001	-1	680	10001	1	920
00010	-2	560	10010	2	1040
00011	-3	440	10011	3	1160
00100	-4	320	10100	4	1280
00101	-5	200	10101	5	1400
00110	-6	80	10110	6	1520
00111	-7	-40	10111	7	1640
01000	-8	-160	11000	8	1760
01001	-9	-280	11001	9	1880
01010	-10	-400	11010	10	2000
01011	-11	-520	11011	11	2120
01100	-12	-640	11100	12	2240
01101	-13	-760	11101	13	2360
01110	-14	-880	11110	14	2480
01111	-15	-1000	11111	15	2600

Table 16 – Ratio sensitivity temperature coefficient

The Sensitivity Temperature Coefficient to compensate the thermal degradation of the magnets field strength is set by the TC parameter in the MTP.

The TC_s characteristic vs. the TC<4:0> code is listed in Table 16 – Ratio sensitivity temperature coefficient. The reference temperatures for the TC_s in the table is 35°C to 125°C. The TC_s has a change of ±120ppm/°C per digit in code change.

The sensor MTP parameter TC is pre-programmed with a TC_s = 1100ppm/°C ±500ppm/°C. See section 8.3 Sensitivity Temperature Coefficient Characteristic. The MTP has 2 calibrated TC information parameters for TC_s = 350ppm/°C stored in TC350_DATA and TC_s = 2000ppm/°C stored in TC2000_DATA.

The procedure to reprogram the TC_s of the sensor is as follows:

- Read the TC_s code from the sensors MTP memory;
- Calibrate the table of the Theoretical TC_s characteristics so the TC_s code of the MTP memory matches with 1100ppm/°C;
- Select the TC_s code from the calibrated table for the targeted TC_s of the application magnet.

Example:

The preprogrammed TC code for 1100ppm/°C read from the MTP, TC_{default} = 2signed = 18dec.

To reprogram the TC_s to 2000ppm/°C, TC₂₀₀₀ = TC_{default} + 8 = 10signed = 26dec.

For a TC_s of 350ppm/°C, TC₃₅₀ = TC_{default} - 6 = -4signed = 4dec.

Example TC_s characteristic vs. the TC<4:0> code signed

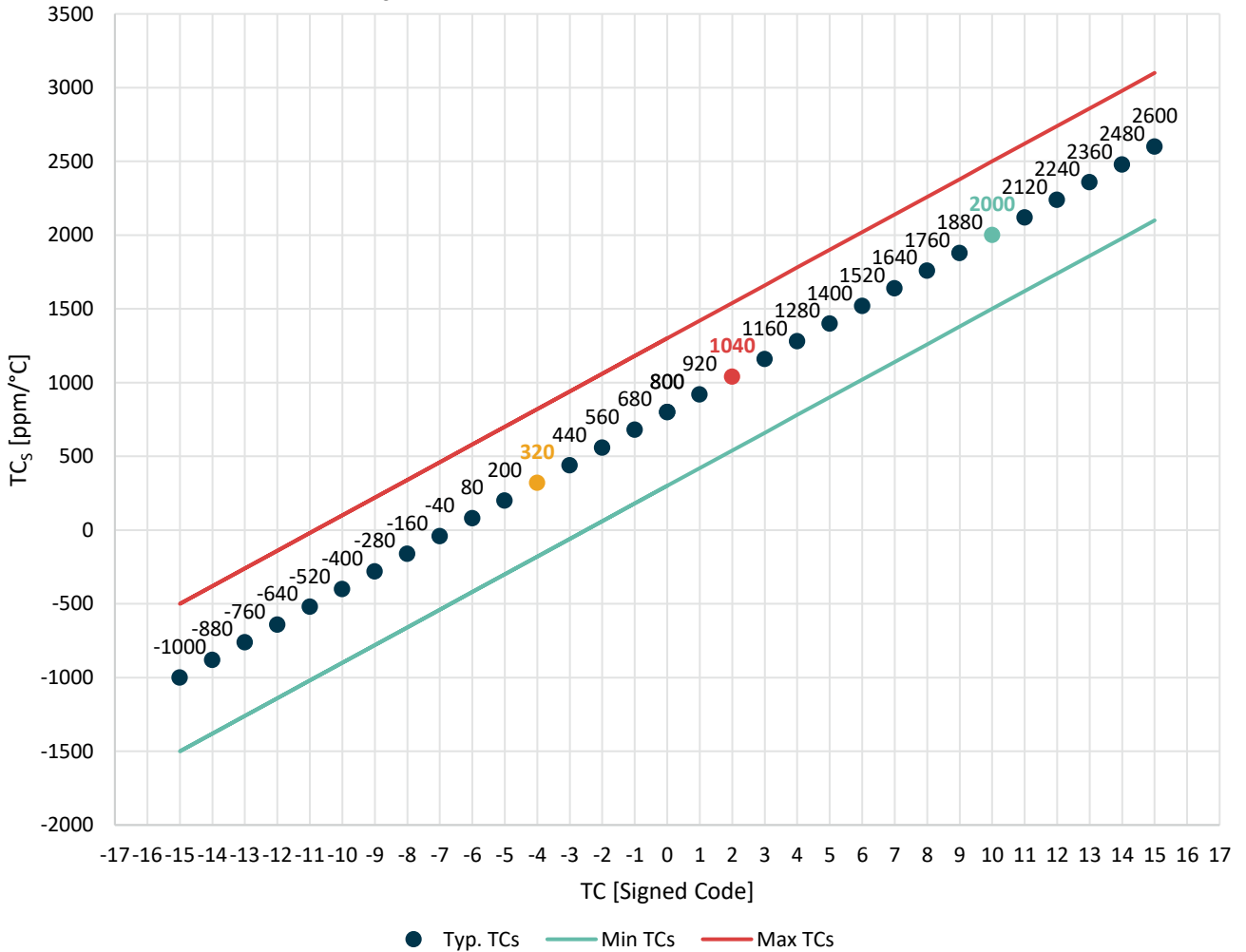

Figure 18 - Example TCS characteristic vs. the TC[4:0] code signed value

11.5.1. TC

The MTP parameter TC is the 5bit TC code used by the MLx90381 sensor. The value of TC is pre-programmed to a code that corresponds to a $TC_s = 1100\text{ppm}/^\circ\text{C}$.

11.5.2. TC350_DATA

The MTP parameter TC350_DATA is the 4bit TC code that corresponds to a $TC_s = 350\text{ppm}/^\circ\text{C}$. The MTP parameter TC350_DATA is information data that is not used by the MLX90381 sensor. To have a $TC_s = 350\text{ppm}/^\circ\text{C}$, the MTP parameter TC350_DATA + sign bit needs to be copied to the MTP parameter TC ($TC_{5\text{bit}} = TC350_DATA_{4\text{bit}} + 0x00$).

11.5.3. TC2000_DATA

The MTP parameter TC2000_DATA is the 4bit TC code that corresponds to a $TC_s = 2000\text{ppm}/^\circ\text{C}$. The MTP parameter TC2000_DATA is information data that is not used by the MLX90381 sensor. To have a $TC_s = 2000\text{ppm}/^\circ\text{C}$, the MTP parameter TC2000_DATA + sign bit needs to be copied to the MTP parameter TC ($TC_{5\text{bit}} = TC2000_DATA_{4\text{bit}} + 0x10$).

11.6. Memory Lock

The Memlock bit of the MTP locks the write access to the MTP. The MTP can still be read after Memlock. Setting the Memlock after the sensor is calibrated is highly recommended for production parts.

12. Functional Safety

12.1. Safety Manual

The safety manual, available upon request, contains the necessary information to integrate the MLX90381 component in a safety related item, as Safety Element Out of Context (SEooC). It includes:

- The description of the Product Development lifecycle tailored for the Safety Element.
- A summary of the Technical Safety concept.
- The description of Assumptions of Use (AoU) of the element with respect to its intended use, including:
 - ❑ assumption on the device safe state;
 - ❑ assumptions on fault tolerant time interval and multiple-point faults detection interval;
 - ❑ assumptions on the context, including its external interfaces;
- The safety analysis results at the device level useful for the system integrator; HW architectural metrics and description of dependent failures initiators.
- The description and the result of the functional safety assessment process; list of confirmation measures and description of the independency level.

12.2. Safety Mechanisms

The MLX90381 provides numerous self-diagnostic features (safety mechanisms). Those features increase the robustness of the IC functionality by:

- Preventing the IC from providing an erroneous output signal
- Reporting the failure by switching off the two output pins (high impedance).

Legend

- Coverage

High-Z: outputs are set in high impedance mode

DRT: Diagnostic Reporting Time (see General Electrical Specifications for values)

DIS_DIAGS: This safety mechanism can be disabled by setting DIS_DIAGS = 1 (see section 10 End User Programmable Items). This option shall not be used in application mode!

Table 17 - Legend

Safety mechanism name	analog	digital	Support functions	Module & Package	DRT	Reporting mode	DIS_DIAGS
Envelope detectors (DIAG_ENV)	•				DRT	HIGH_Z	YES
Common mode detectors (DIAG_SH)	•				DRT	HIGH_Z	YES
Output amplifiers diagnostics (DIAG_OUT)	•				DRT	HIGH_Z	YES
Overcurrent detector (DIAG_OCD)	•			•	DRT	HIGH_Z	NO
Undervoltage detection (POR)			•	•	DRT	HIGH_Z	NO
Overvoltage detection (OV)			•	•	DRT	HIGH_Z	NO
Memory failure detection (ECC)		•			N/A	HIGH_Z	NO
Registers failure detection (CRC)		•			DRT_CRC	HIGH_Z	NO
Oscillator and clock generator monitor (DIAG_OSC)			•		DRT	HIGH_Z	YES

Table 18 - Safety mechanism

Safety measure name	analog	digital	Support functions	Module & Package
Redundant ground pin (Vss2)				•
Redundant switches and wiring in Hall elements	•			

Table 19 - Safety measure

13. Recommended Application Diagrams

13.1. MLX90381 in DFN-6 Package

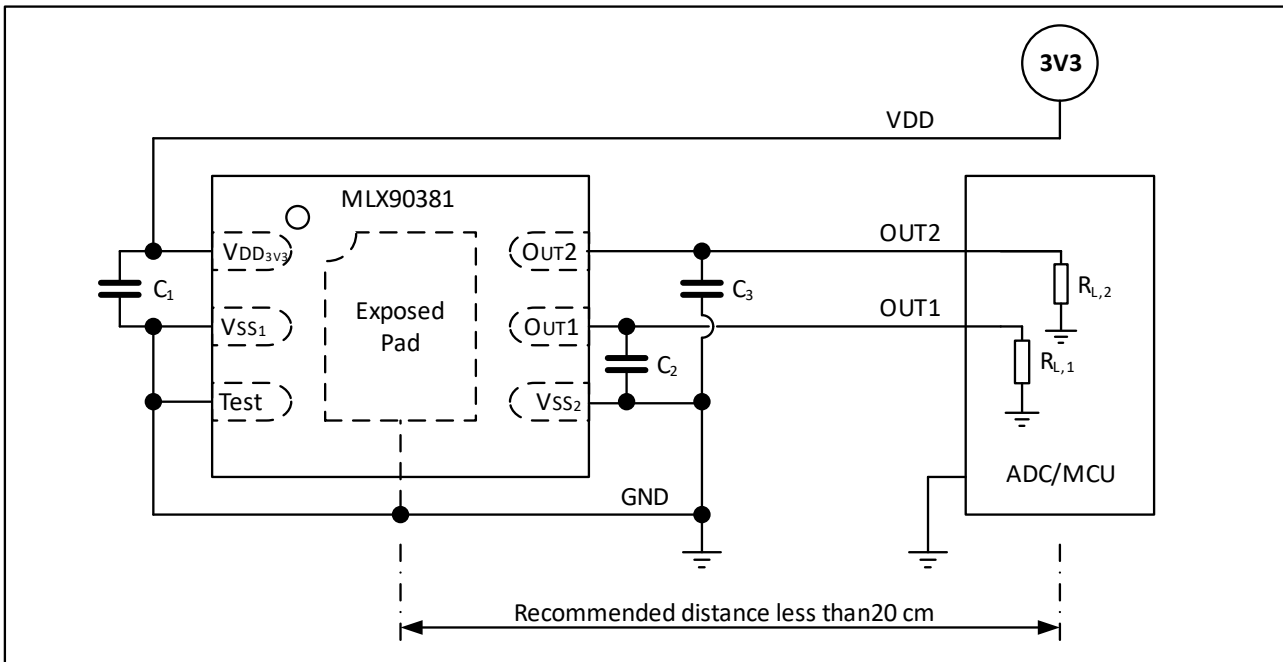

Figure 19 – Recommended application diagram

Component	min	Typ.	Max	Remark
C ₁		100 nF	-	Close to the IC pin
C ₂ , C ₃ (C _L)	-	1 nF	2.2 nF	
R _{L1} , R _{L2}	50kΩ	110kΩ	∞	Min. to Typ. Load is required for I ² C communication and enabling the diagnostic level for the MCU.

Table 20 – Recommended application components

14. Package Information

14.1. DFN-6 Package Dimensions and Sensitive Spot Location

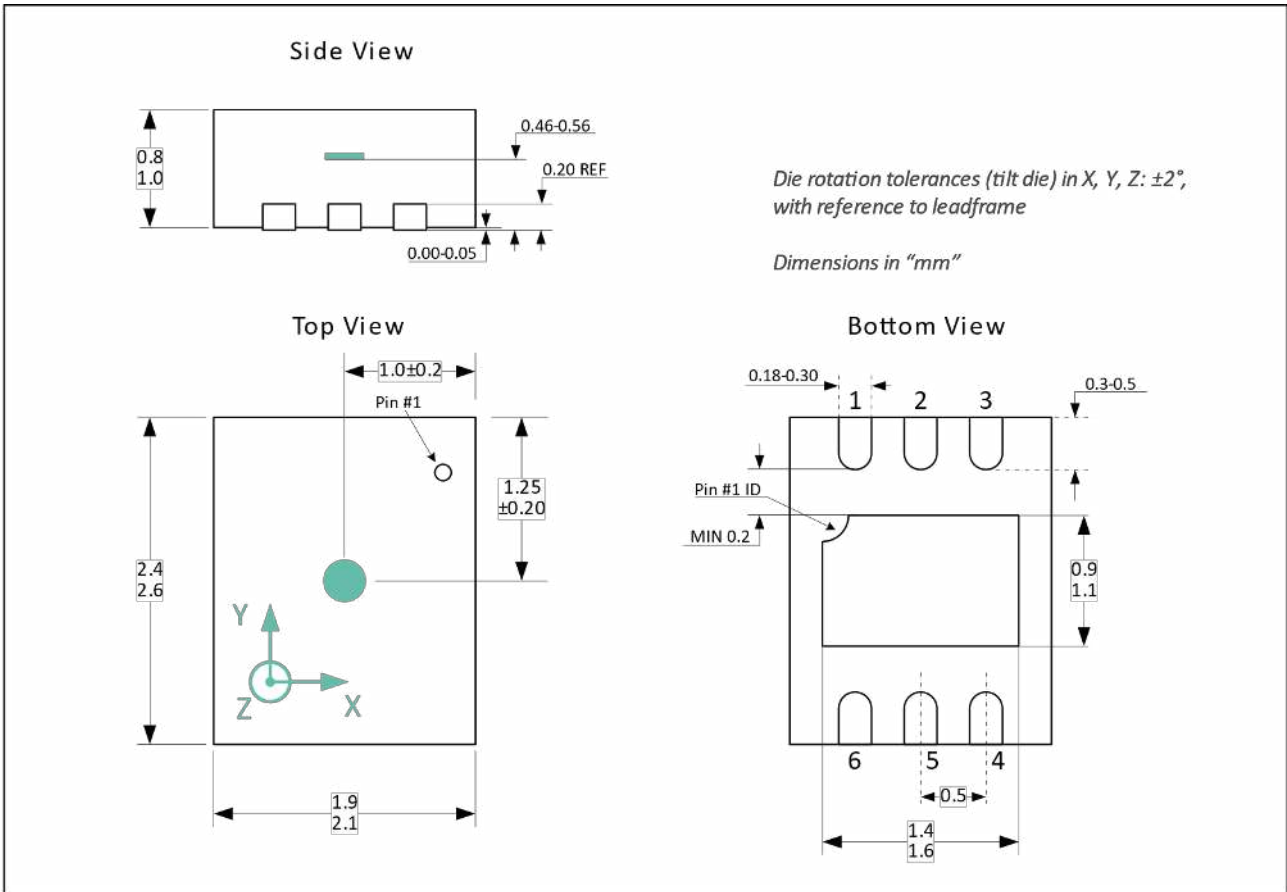

Figure 20 – DFN-6 package dimensions and sensitive spot location

14.2. DFN-6 Pinout and Marking

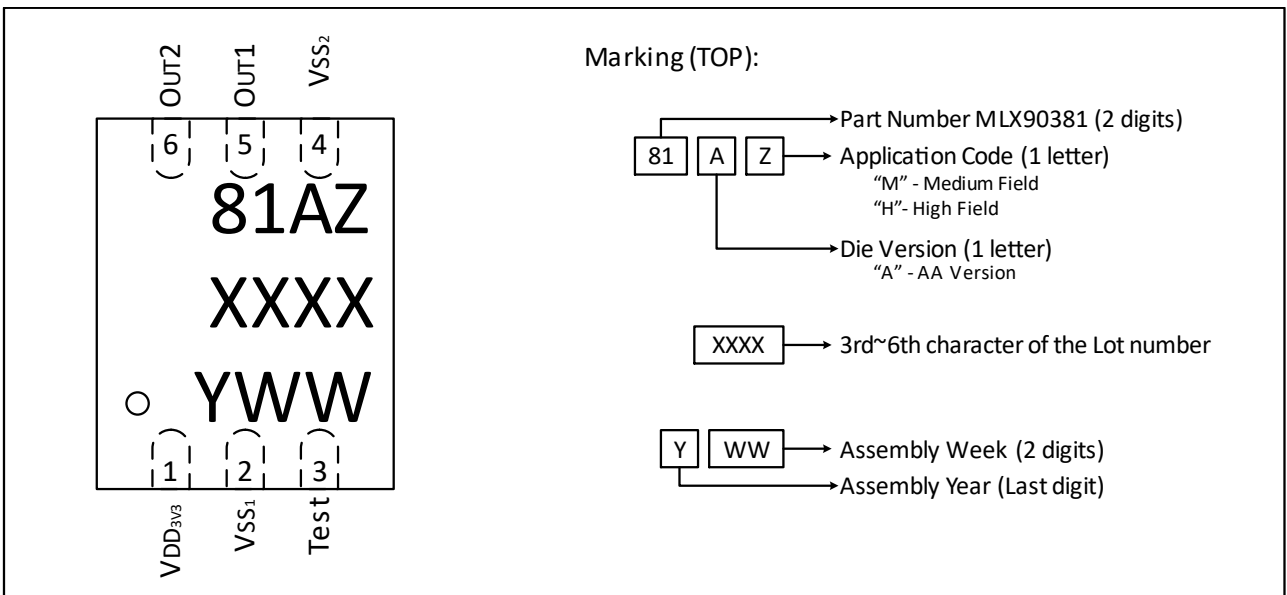

Figure 21 – DFN-6 pin out and marking

15. Standard Information

Our products are classified and qualified regarding soldering technology, solderability and moisture sensitivity level according to standards in place in Semiconductor industry.

For further details about test method references and for compliance verification of selected soldering method for product integration, Melexis recommends reviewing on our web site the General Guidelines soldering recommendation (<http://www.melexis.com/en/quality-environment/soldering>)

For all soldering technologies deviating from the one mentioned in above document (regarding peak temperature, temperature gradient, temperature profile etc.), additional classification and qualification tests have to be agreed upon with Melexis.

For package technology embedding trim and form post-delivery capability, Melexis recommends consulting the dedicated trim & form recommendation application note : “Lead Trimming and Forming Recommendations” (<https://www.melexis.com/en/documents/documentation/application-notes/application-note-lead-trimming-and-forming-recommendations>).

Melexis is contributing to global environmental conservation by promoting lead free solutions. For more information on qualifications of RoHS compliant products (RoHS = European directive on the Restriction Of the use of certain Hazardous Substances) please visit the quality page on our website: <http://www.melexis.com/en/quality-environment>.

16. ESD Precautions

Electronic semiconductor products are sensitive to Electro Static Discharge (ESD).

Always observe Electro Static Discharge control procedures whenever handling semiconductor products.

17. Contact

For the latest version of this document, go to our website at www.melexis.com.

For additional information, please contact our Direct Sales team and get help for your specific needs:

Europe, Africa	Email: sales_europe@melexis.com
Americas	Email: sales_usa@melexis.com
Asia	Email: sales_asia@melexis.com

18. Disclaimer

The content of this document is believed to be correct and accurate. However, the content of this document is furnished "as is" for informational use only and no representation, nor warranty is provided by Melexis about its accuracy, nor about the results of its implementation. Melexis assumes no responsibility or liability for any errors or inaccuracies that may appear in this document. Customer will follow the practices contained in this document under its sole responsibility. This documentation is in fact provided without warranty, term, or condition of any kind, either implied or expressed, including but not limited to warranties of merchantability, satisfactory quality, non-infringement, and fitness for purpose. Melexis, its employees and agents and its affiliates' and their employees and agents will not be responsible for any loss, however arising, from the use of, or reliance on this document. Notwithstanding the foregoing, contractual obligations expressly undertaken in writing by Melexis prevail over this disclaimer.

This document is subject to change without notice, and should not be construed as a commitment by Melexis. Therefore, before placing orders or prior to designing the product into a system, users or any third party should obtain the latest version of the relevant information. Users or any third party must determine the suitability of the product described in this document for its application, including the level of reliability required and determine whether it is fit for a particular purpose.

This document as well as the product here described may be subject to export control regulations. Be aware that export might require a prior authorization from competent authorities. The product is not designed, authorized or warranted to be suitable in applications requiring extended temperature range and/or unusual environmental requirements. High reliability applications, such as medical life-support or life-sustaining equipment or avionics application are specifically excluded by Melexis. The product may not be used for the following applications subject to export control regulations: the development, production, processing, operation, maintenance, storage, recognition or proliferation of:

- 1. chemical, biological or nuclear weapons, or for the development, production, maintenance or storage of missiles for such weapons;*
- 2. civil firearms, including spare parts or ammunition for such arms;*
- 3. defense related products, or other material for military use or for law enforcement;*
- 4. any applications that, alone or in combination with other goods, substances or organisms could cause serious harm to persons or goods and that can be used as a means of violence in an armed conflict or any similar violent situation.*

No license nor any other right or interest is granted to any of Melexis' or third party's intellectual property rights.

If this document is marked "restricted" or with similar words, or if in any case the content of this document is to be reasonably understood as being confidential, the recipient of this document shall not communicate, nor disclose to any third party, any part of the document without Melexis' express written consent. The recipient shall take all necessary measures to apply and preserve the confidential character of the document. In particular, the recipient shall (i) hold document in confidence with at least the same degree of care by which it maintains the confidentiality of its own proprietary and confidential information, but no less than reasonable care; (ii) restrict the disclosure of the document solely to its employees for the purpose for which this document was received, on a strictly need to know basis and providing that such persons to whom the document is disclosed are bound by confidentiality terms substantially similar to those in this disclaimer; (iii) use the document only in connection with the purpose for which this document was received, and reproduce document only to the extent necessary for such purposes; (iv) not use the document for commercial purposes or to the detriment of Melexis or its customers. The confidentiality obligations set forth in this disclaimer will have indefinite duration and, in any case, they will be effective for no less than 10 years from the receipt of this document.

This disclaimer will be governed by and construed in accordance with Belgian law and any disputes relating to this disclaimer will be subject to the exclusive jurisdiction of the courts of Brussels, Belgium.

The invalidity or ineffectiveness of any of the provisions of this disclaimer does not affect the validity or effectiveness of the other provisions. The previous versions of this document are repealed.

Melexis © - No part of this document may be reproduced without the prior written consent of Melexis. (2023)

IATF 16949 and ISO 14001 Certified