

Product Data Sheet

8315100157

VWLG150KJLRS

AF172-00157 24V P/2

6800

**ebmpapst**

engineering a better life



AF172-00157 24V P/2 6800

INDEX

- 1 General ..... 3**
- 2 Mechanics ..... 3**
  - 2.1 General ..... 3
  - 2.2 Connections ..... 3
- 3 Operating Data ..... 5**
  - 3.1 Electrical Interface - Input ..... 5
  - 3.2 Electrical Operating Data ..... 6
  - 3.3 Electrical Interface - Output ..... 7
  - 3.4 Electrical Features ..... 8
  - 3.5 Aerodynamics ..... 9
  - 3.6 Sound Data ..... 10
- 4 Environment ..... 10**
  - 4.1 General ..... 10
  - 4.2 Climatic Requirements ..... 10
  - 4.3 EMC ..... 10
- 5 Safety ..... 12**
  - 5.1 Electrical Safety ..... 12
  - 5.2 Approval Tests ..... 12
- 6 Reliability ..... 12**
  - 6.1 General ..... 12

**1 General**

Fan type	Axial	
Rotating direction looking at rotor	Counterclockwise	
Airflow direction	Air outlet over struts	
Bearing system	Ball bearing	
Mounting position - shaft	Any	

**2 Mechanics****2.1 General**

Width	150,0 mm	
Depth	51,0 mm	
Diameter	172,0 mm	
Mass	0,86 kg	
Housing material	Metal	
Impeller material	Plastic	
Max. torque when mounted across both mounting flanges Screw size	Wire outlet corner: 190 Ncm Remaining corners: 190 Ncm ISO 4762 - M4 degreased, without an additional brace and without washer	

**2.2 Connections**

Electrical connection	Wires	
Lead wire length	L = 365 mm	
Tolerance	+ - 10,0 mm	
Tube length	S = 10 mm	
Tolerance	+ - 10 mm	

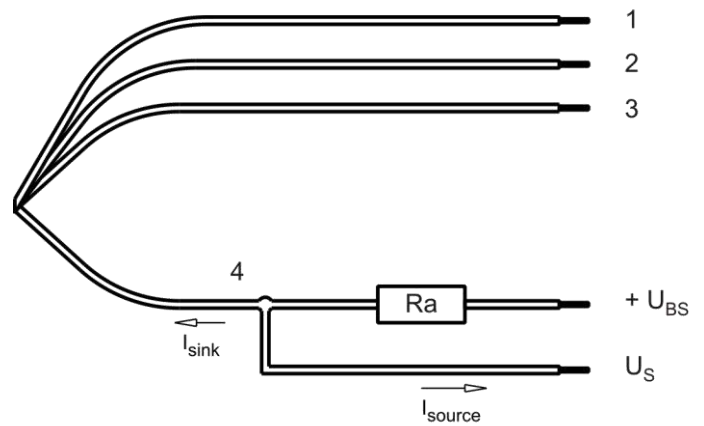

Wire	Color	Operation	Wire size	Insulation diameter
1	red	+ UB	AWG 20	2,05 mm
2	blue	- GND	AWG 20	2,05 mm
3	violet	PWM	AWG 22	1,3 mm
4	white	Tacho	AWG 22	1,3 mm

The auxiliaries shown on the schematic diagram (which are required for the intended use) are not part of our delivery.

### 3 Operating Data

#### 3.1 Electrical Interface - Input

Control input	PWM
---------------	-----

#### Features

Input type	Open collector	
PWM - Frequency		typical: 2 kHz

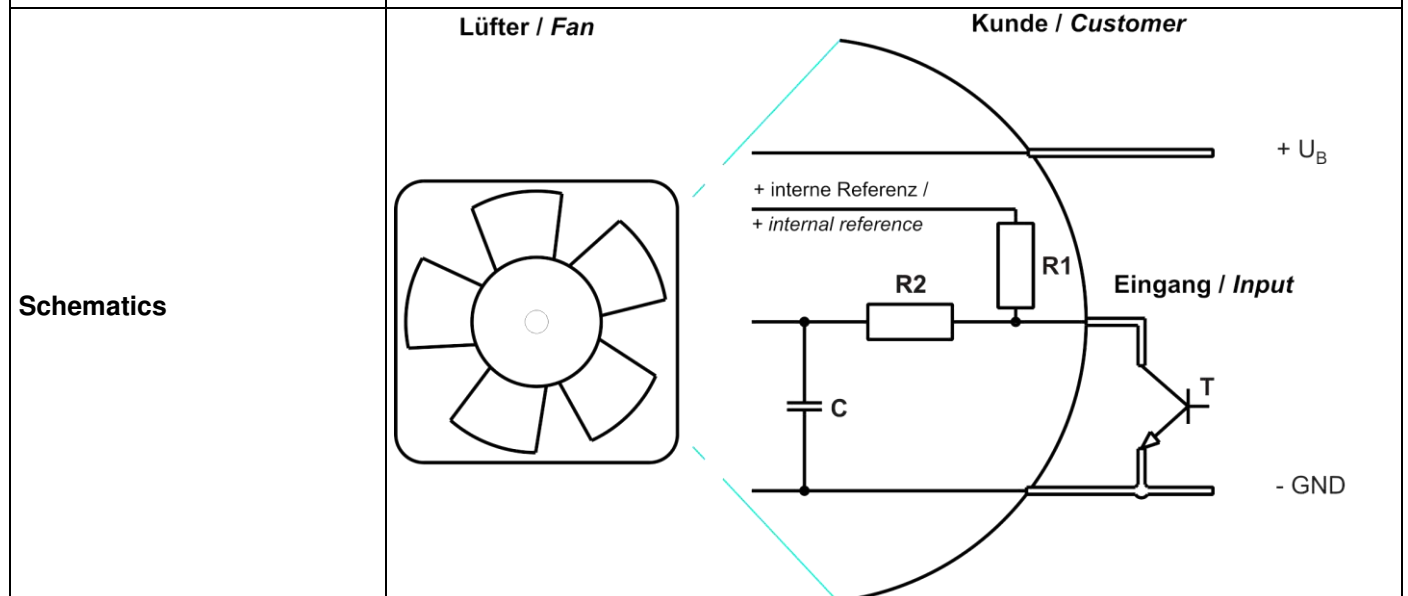
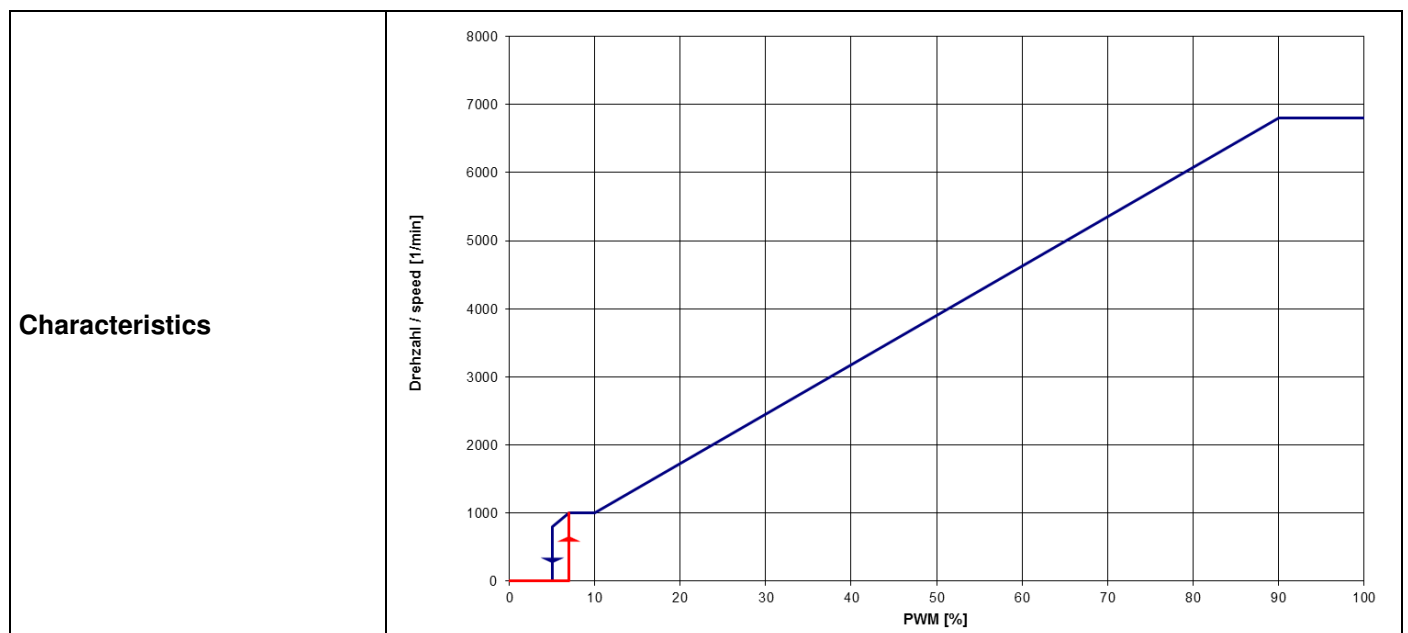

PWM input transistor requirements:  
 $U_{CEmax.} \Rightarrow 12\text{ V}$ ;  $I_{Sink\ max.} > 5\text{ mA}$ ;  $U_{CEsat.} < 0,15\text{ V}$

**Speed control:**

By Puls width modulation (PWM) 0 ... 100%

Open collector in relation to signal-ground  
 f = 2kHz +-20%

**Information to the curve:**

0% - <=7% PWM: 0 1/min (Fan off)  
 7% PWM: 1.000 1/min (Start-up, comming from 0% PWM)  
 7% - 10 % PWM: 1.000 1/min (corresp. to min fan speed)  
 10% - 90% PWM: Linear increasing curve  
 90% - 100% PWM: 8.300 1/min (corresp. to max fan speed)  
 5% PWM: 800 1/min or 0 1/min (Fan turns off, comming from 100% PWM)

**3.2 Electrical Operating Data**

Measurement conditions: Normal air density = 1,2 kg/m3; Temperature 23°C +/- 3°C; Motor axis horizontal; warm-up time before measuring 5 minutes (unless otherwise specified). In the intake and outlet area should not be any solid obstruction within 0,5 m.

$\Delta p = 0$ : corresp. to free air flow (see chapter aerodynamics)  
 I: corresp. to arithm. mean current value

Name	Condition
PWM 0001	PWM: 100 %;

Features	Condition	Symbol	Values		
			16 V	24 V	30 V
Voltage range		U	16 V		30 V
Nominal voltage		$U_N$		24 V	
Power consumption	$\Delta p = 0$	P	31 W	58 W	58 W
Tolerance	PWM 0010		+/- 15 %	+/- 15 %	+/- 15 %
Current consumption	$\Delta p = 0$	I	1.900 mA	2.375 mA	1.900 mA
Tolerance	PWM 0010		+/- 15 %	+/- 15 %	+/- 15 %
Speed	$\Delta p = 0$	n	5.400 1/min	6.800 1/min	6.800 1/min
Tolerance	PWM 0010		+/- 10 %	+/- 10 %	+/- 10 %

3.3 Electrical Interface - Output

Tacho type	/2 (open collector)
------------	---------------------

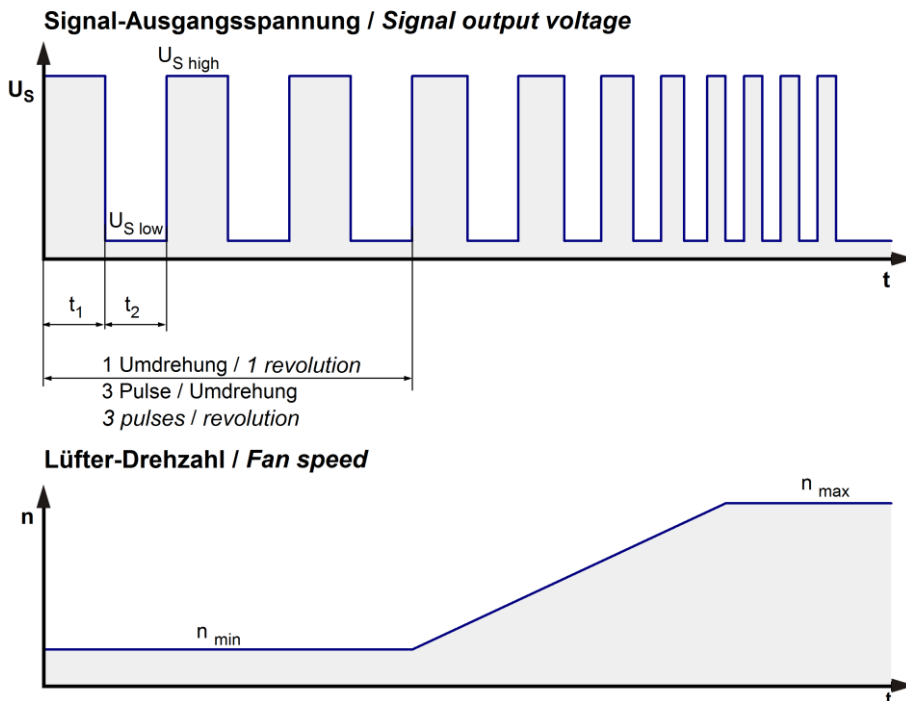

$$R_a = \frac{U_{BS} - U_{S\ low}}{I_{sink}}$$

Lüfter / Fan      Kunde / Customer

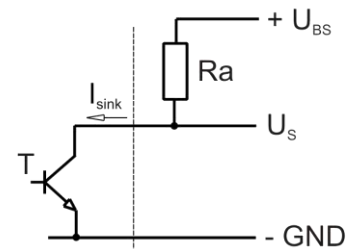

Features	Note	Values
Tacho operating voltage	$U_{BS}$	$\leq 60\text{ V}$
Tacho signal Low	$U_{S\ low}$	$\leq 0,4\text{ V}$
Tacho signal High	$U_{S\ high}$	
Maximum sink current	$I_{sink}$	$\leq 20\text{ mA}$
External resistor	External resistor $R_a$ from $U_{BS}$ to $U_S$ required. All voltages measured to GND.	
Tacho frequency	$(3 \times n) / 60$	
Tacho isolated from motor	No	
Slew rate		$\Rightarrow 0,5\text{ V/us}$

n = revolutions per minute (1/min)

3.4 Electrical Features

Electronic function	Speed-Controlled	
Reversed polarity protection	Rectifying diode	
Max. residual current at $U_N$	$I_F \leq 5$	
Locked rotor protection	Auto restart	
Locked rotor current at $U_N$	$I_{block}$	
Clock signal at locked rotor	$t_3 / t_4$ typical: 3 s / 10 s	
Extended Downtime	$t_5$ : 30 s after 5 start-up tests	
Internal fuse	Littelfuse NANO2 > Very Fast-Acting > 451/453 Series 6,3A / 125V (Art.No.: 045106.3MRL)	
Voltage control *)	Fan turns on at $U_B > 34$ V or $< 74$ V Fan turns off at $U_B < 32$ V or $> 76$ V	

\*) This fan has an undervoltage and overvoltage control circuit integrated which turns the motor off if the voltage is out of range.

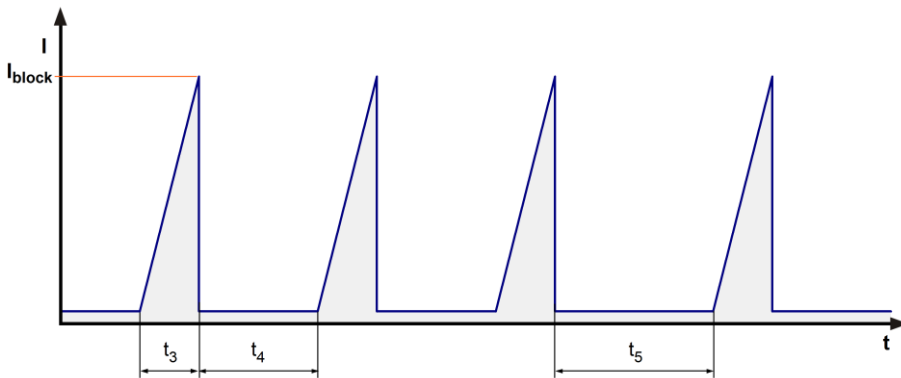



3.5 Aerodynamics

Measurement conditions:

Measured with a double chamber intake rig acc. to DIN EN ISO 5801.  
 Normal air density = 1,2 kg/m<sup>3</sup>; Temperature 23°C +/- 3°C;  
 In the intake and outlet area should not be any solid obstruction within 0,5 m. Motor shaft horizontal.  
 The information is only valid under the specified test conditions and may be changed by the installation conditions. If there are deviations from the standard test conditions, the characteristic values must be checked under the installed conditions. Power consumption of the fan motor when operating at normal voltage is shown. Depending on the operating conditions of the application, the power input may be higher.

a.) Operation condition:

6.800 1/min at free air flow	PWM 100 %;		
------------------------------	------------	--	--

Max. free-air flow ( $\Delta p = 0 / \dot{V} = \text{max.}$ )	530 m <sup>3</sup> /h	
Max. static pressure ( $\Delta p = \text{max.} / \dot{V} = 0$ )	660 Pa	

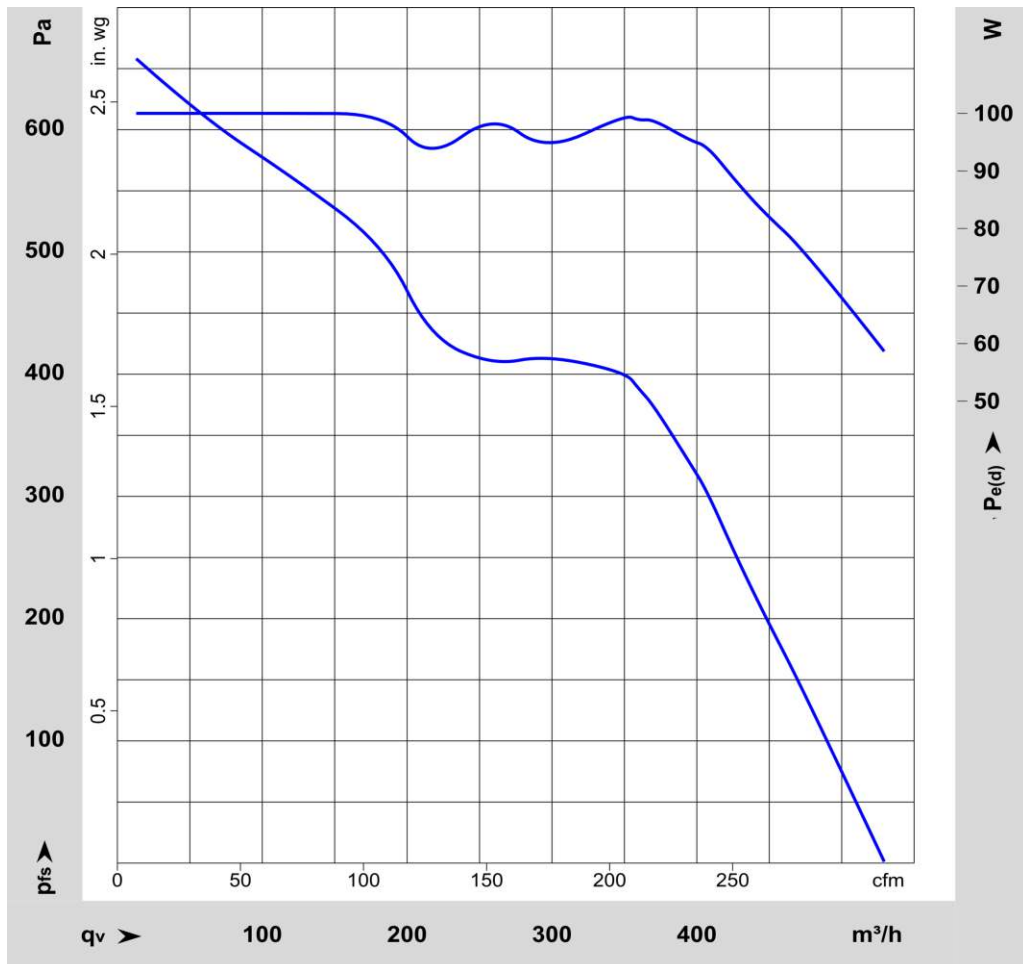

### 3.6 Sound Data

Measurement conditions: Sound pressure level: 1 meter distance between microphone and the air intake.  
Sound power level: According to ISO 13347-3.  
Measured in a semianechoic chamber with a background noise level of  $L_p(A) < 5 \text{ dB(A)}$   
For further measurement conditions see chapter aerodynamics.

a.) Operation condition:

6.800 1/min at free air flow	PWM 100 %;		
------------------------------	------------	--	--

Optimal operating point	425 m <sup>3</sup> /h @ 255 Pa		
Sound power level at the optimal operating point	7,7 bel(A)		
Sound pressure level at free air flow, measured in rubber bands	71 dB(A)		

## 4 Environment

### 4.1 General

Min. permitted ambient temperature TU min.	-20 °C		
Max. permitted ambient temperature TU max.	70 °C		
Min. permitted storage temperature TL min.	-40 °C		
Max. permitted storage temperature TL max.	80 °C		

### 4.2 Climatic Requirements

Humidity requirements	humid heat, constant; according to DIN EN 60068-2-78, 14 days		
Water exposure	None		
Dust requirements	None		
Salt fog requirements	None		

Permitted application area:

The product is intended for use in sheltered rooms with controlled temperature and controlled humidity. Directly exposure to water must be avoided.

Pollution degree 1 (according DIN EN 60664-1)

There is either no pollution or it occurs only dry, non-conductive pollution. The pollution has no negative impact.

Please require severity levels and specification parameters from the responsible development departments.

### 4.3 EMC

<b>Kind</b>	<b>Conducted Emission; Voltage; 150 kHz-30 MHz (without PE)</b>
According	DIN EN 55032:2016-02
Check accuracy / Limit	Class B
Result	Below limit Class B

<b>Kind</b>	<b>Radiated Emission; 30 MHz - 1000 MHz (with PE)</b>
Accordinging	DIN EN 55032:2016-02
Ceck accuracy / Limit	Class B
Result	Below limit Class B

<b>Kind</b>	<b>Radiated Emission; 30 MHz - 1000 MHz (without PE)</b>
Accordinging	DIN EN 55032:2016-02
Ceck accuracy / Limit	Class B
Result	Below limit Class B

<b>Kind</b>	<b>Electrostatic Discharge Immunity Test</b>
Accordinging	DIN EN 61000-4-2:2001-12
Ceck accuracy / Limit	Contact Discharge +/- 4 kV; Air Discharge +/- 8 kV
Result	A: The monitored function operates as designed during and after exposure to a disturbance.

<b>Kind</b>	<b>Electromagnetic Field Immunity Test</b>
Accordinging	DIN EN 61000-4-3:2006-12
Ceck accuracy / Limit	10 V/m; 80 - 1000 MHz; AM; m = 0,8; f = 1 kHz; 1%; t = 3 s
Result	A: The monitored function operates as designed during and after exposure to a disturbance.

<b>Kind</b>	<b>Electrical Fast Transient / Burst Immunity Test</b>
Accordinging	DIN EN 61000-4-4:2005-07
Ceck accuracy / Limit	+/- 2 kV on Power Lines; Coupling: POS, NEG, {PE}, ALL, 5 kHz and 100 kHz; 1 min
Result	B: The monitored function may deviate from designed performance to a specified level during exposure to a disturbance or revert to a fail safe mode or operation, but shall return to normal operation after the disturbance is removed.

<b>Kind</b>	<b>Immunity to Conducted Disturbances, Induced by RF-Fields</b>
Accordinging	DIN EN 61000-4-6:2001-12
Ceck accuracy / Limit	10 Vrms; 150 kHz - 80 MHz; AM; m = 0,8; f = 1 kHz; 1%; t = 3 s
Result	A: The monitored function operates as designed during and after exposure to a disturbance.

**5 Safety**

**5.1 Electrical Safety**

Dielectric strength DIN EN 62368 and DIN EN 60335 A.) Type test Measuring conditions: After 48h of storage at 95% R.H. and 25°C. No arcing or breakdown is allowed! All connections together to ground. B.) Routine test Measuring conditions: At indoor climate. No arcing or breakdown is allowed! All connections together to ground.	500 VAC / 1 Min.  850 VDC / 1 Sec.	
Isolation resistance Measuring conditions: After 48h of storage at 95% R.H. and 25°C measured with U=500 VDC for 1 min.	RI > 10 MOhm	
Clearance / creepage distance	0,5 mm / 1,2 mm	
Protection class	III	

**5.2 Approval Tests**

CE	EC Declaration of Conformity	Yes
EAC	Eurasian Conformity	Yes
UL	Underwriters Laboratories	Yes / UL507, Electric Fans E38324
VDE	Association for Electrical, Electronic and Information Technologies	Yes / Approval acc. to EN 62368 - Audio/video, information and communication technology equipment
CSA	Canadian Standards Association	Yes / CSA audited by UL according to C22.2 No. 113 Fans and Ventilators
CCC	China Compulsory Certification	Not applicable

**6 Reliability**

**6.1 General**

Life expectancy L10 at TU = 40 °C	84.000 h	
Life expectancy L10 at TU max.	42.000 h	
Life expectancy L10 acc. to IPC 9591 at TU = 40 °C	141.750 h	

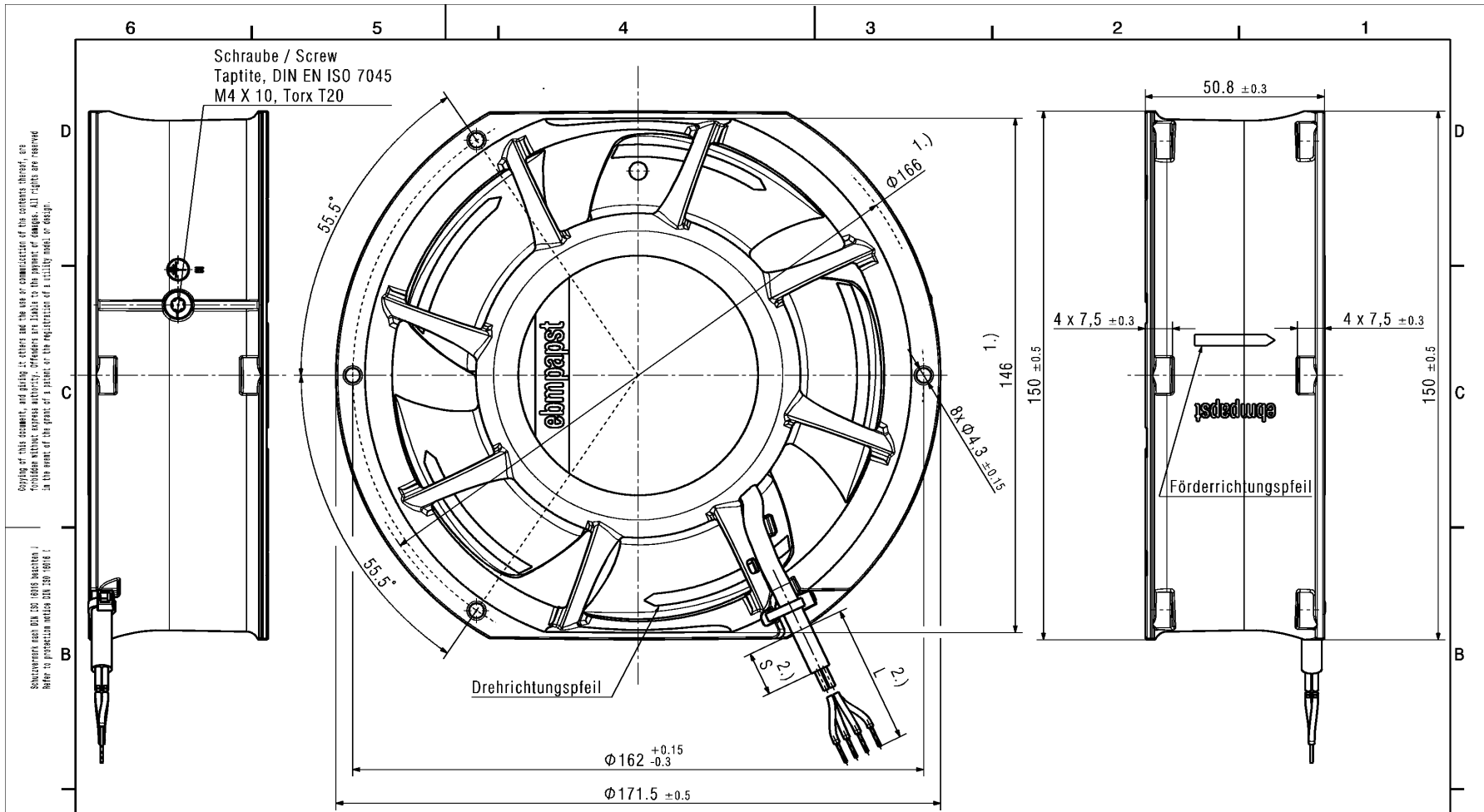

COPIES OF THIS DOCUMENT, AND THEREIN IS, SHALL BE FOR THE USE OF THE ENGINEER AT THE CUSTOMER'S ADDRESS. SEE REVISIONS WITHIN THIS DOCUMENT. REVISIONS ARE LIMITED TO THE NUMBER OF COUNTERS. ALL RIGHTS ARE RESERVED IN THE EVENT OF THE PRESENT OF A PART OR THE REGISTERATION OF A PATENT FOR DESIGN.

SONDERZUGEBEN NACH DIN EN ISO 9016 UNTERSONDERZUGEBEN NACH DIN EN ISO 9016 UNTERSONDERZUGEBEN NACH DIN EN ISO 9016 UNTERSONDERZUGEBEN NACH DIN EN ISO 9016 UNTERSONDERZUGEBEN NACH DIN EN ISO 9016

- 1.) Maße aus Montageausschnitt
- 2.) Anzahl und Länge der Litzen/Schlauch siehe Produktspezifikation
- Axialspiel der Kugellager mit Feder spielfrei verspannt

- 1.) measures of mounting cut out
- 2.) length and number of wires/tube see product specification
- ball bearing without clearance by a pre-load spring

Dokument-Status / Document-Status CAD-Referenzmodell / 3D-Referenzmodell		CAD-Teilung / CAD-Environment 815100009 CPR000		RefKategorie / Material:		Volumen / Volume (cm³): Gewicht / Mass (g):	
Tolerierung / Tolerances: Allgemeintoleranzen / Gen. Tolerances:	And.-Nr. / Change No.:	Datum Name		Titel / Title:		Zeich.-Nr. / Drawing No:	Ers.f.-Zchg. / Replaces:
	Bearb. / Drawn: Gepr. / Checked: Freig. / Released:	3D-Referenzmodell / 3D-Referenzmodell	Datum Name		Zeich.-Nr. / Drawing No:		
 ebm-papst St. Georgen GmbH & Co KG		Dokumenttyp / Type of Document		Teil/Dokument (S/Latt./Page)		Index / Index: Format / Size:	