

FR series

Three position single axis thumb controls •
non-contacting Hall effect technology



DISTINCTIVE FEATURES

- Forward-neutral-reverse operation
- ON-OFF-ON analog output
- Choice of 3 actuator colors
- 3 million lifecycles
- Panel sealed up to IP67



ENVIRONMENTAL SPECIFICATIONS

- Operating Temperature: -40 °C to +85 °C (-40 °F to +185 °F)
- Storage Temperature: -40 °C to +85 °C (-40 °F to +185 °F)
- Above Panel Sealing: Up to IP67 (subject to configuration)
- EMC Immunity Level: EN61000-4-3
- EMC Emissions Level: EN61000-6-3: 2001
- ESD: EN61000-4-2



SENSOR SPECIFICATIONS

- Supply Voltage Range: 5.00 VDC \pm 0.1 VDC
- Reverse Polarity Max: -10 V
- Transient Overvoltage Max: 16 V
- Minimum load: 1 K Ω
- Return to Center Voltage Tolerance (POS2): 2.50 VDC \pm 0.50 VDC



MECHANICAL SPECIFICATIONS

- Operating Force: 260 g Nominal into position 2 *
360 g Nominal out of position 2 *
- Maximum Vertical Load: 200 N (45 lbf)
- Maximum Horizontal Load: 150 N (33.7lbf)
- Mechanical Angle of Movement: \pm 25°
- Expected Life: 3 million lifecycles
- Mass/Weight: 18.25 g \pm 5.0 g (0.64 oz \pm 0.18 oz)
- Lever Action (centering): Friction

* Force applied to the top of the castle cap

The company reserves the right to change specifications without notice.



FR series

Three position single axis thumb controls • non-contacting Hall effect technology



MATERIALS

- Body: Glass filled nylon
- Boot: Silicone
- Handles:
1, 2,3 - Glass filled nylon



CONNECTIONS

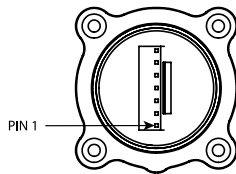
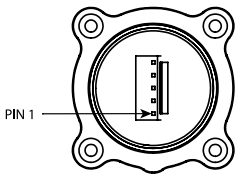
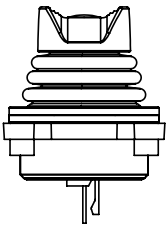

PINOUT SPECIFICATION

	TE 3-647166-5	TE 3-647166-7
Pin 1	Not used	Not used
Pin 2	5 VDC	GND
Pin 3	X (alpha)	X (alpha)
Pin 4	GND	Not used
Pin 5	Not used	Not used
Pin 6	-	5 VDC
Pin 7	-	X (beta)

WIRING SPECIFICATION

Black	Ground & button common
Red	Power (5 V)
Blue	X axis output (alpha)
Blue/White Stripe	X axis output (beta)
Red/White Stripe	Power (5 V) (beta)
Black/White Stripe	Ground (beta)

CONNECTOR TERMINATION OPTION

Single output configurations feature a ve position TE 3-647166-5 connector. Dual output configurations feature a seven position TE 3-647166-7 connector. A mating harness is not included, but may be specified for single output configurations at the time of order for an additional charge. The ve function harness is part number 505-499.



PANEL CUT-OUT

DROP-IN MOUNT

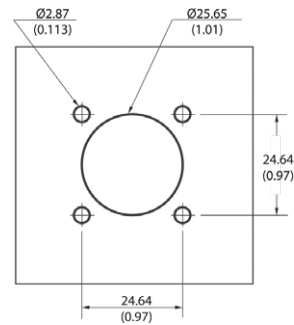

4 x PUSH IN CONNECTORS



- The under panel depth for the Drop-in configuration is 16.02 mm (0.631 in).

REAR MOUNT

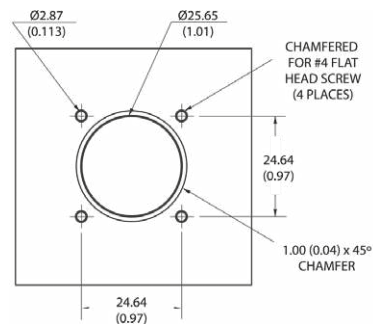

4 x 1/2 FH 55 PHIL SCREW

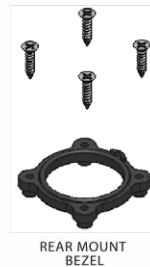

- The maximum panel thickness for the Rear Mount configuration is 2.032 mm (0.08 in).

Three position single axis thumb controls • non-contacting Hall effect technology



BUILD YOUR PART NUMBER

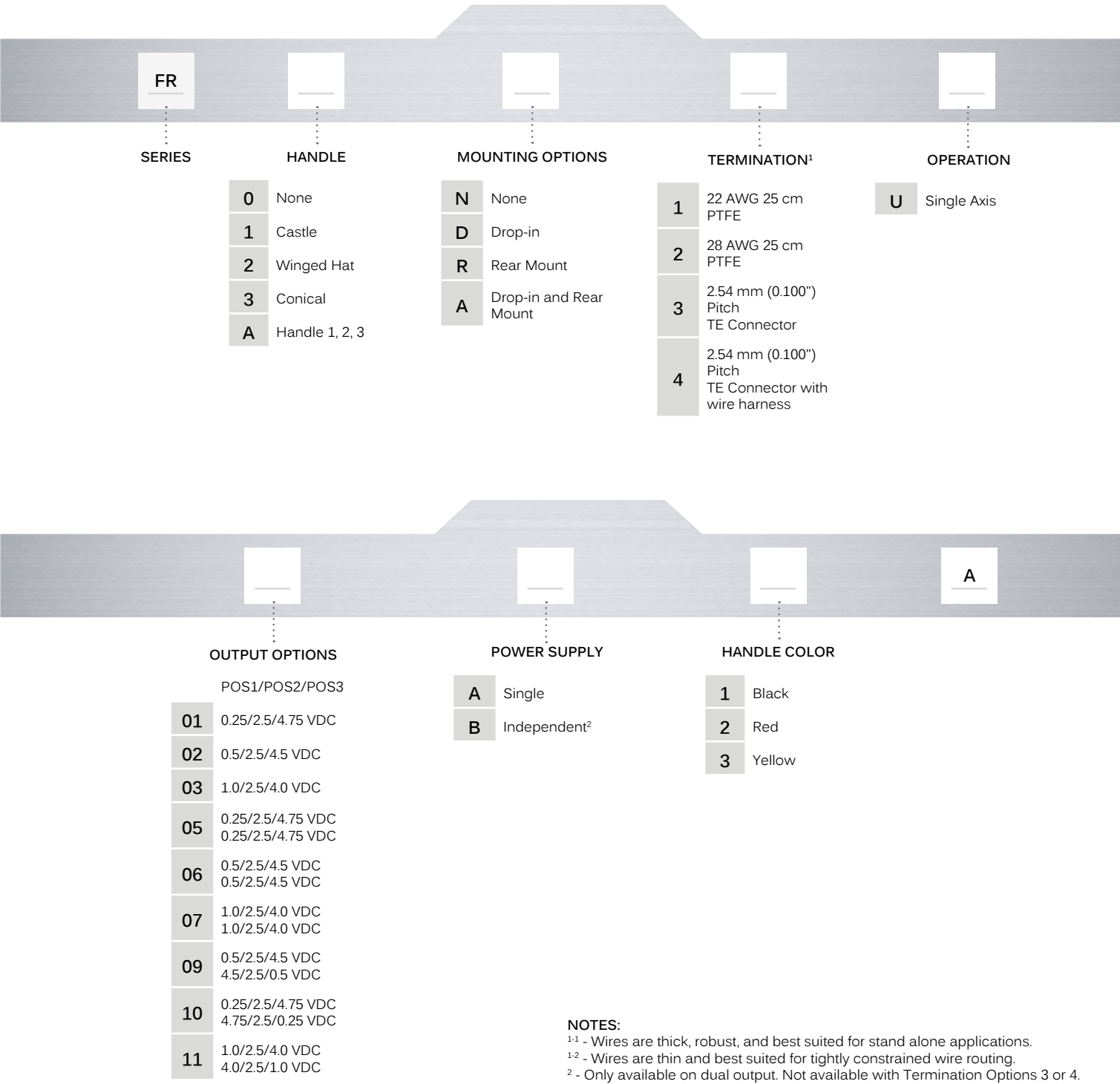

	OUTPUT OPTIONS
	POS1/POS2/POS3
01	0.25/2.5/4.75 VDC
02	0.5/2.5/4.5 VDC
03	1.0/2.5/4.0 VDC
05	0.25/2.5/4.75 VDC 0.25/2.5/4.75 VDC
06	0.5/2.5/4.5 VDC 0.5/2.5/4.5 VDC
07	1.0/2.5/4.0 VDC 1.0/2.5/4.0 VDC
09	0.5/2.5/4.5 VDC 4.5/2.5/0.5 VDC
10	0.25/2.5/4.75 VDC 4.75/2.5/0.25 VDC
11	1.0/2.5/4.0 VDC 4.0/2.5/1.0 VDC

	POWER SUPPLY
A	Single
B	Independent ²

	HANDLE COLOR
1	Black
2	Red
3	Yellow

NOTES:
¹⁻¹ - Wires are thick, robust, and best suited for stand alone applications.
¹⁻² - Wires are thin and best suited for tightly constrained wire routing.
² - Only available on dual output. Not available with Termination Options 3 or 4.



ABOUT THIS SERIES

Mounting accessories : Standard hardware supplied for the Drop-in option: 4 push in connectors, drop-in bezel and an O-ring. Standard hardware supplied for the Rear mount option: 4 x 1/2 FH SS Phil Screws and a rear mount bezel.

FR series

Three position single axis thumb controls • non-contacting Hall effect technology

DIMENSIONS



INDEX NOTCH
90° FROM DIRECTION OF TRAVEL

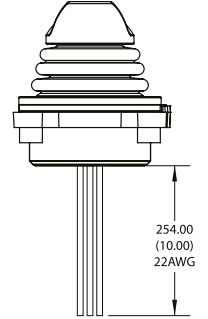
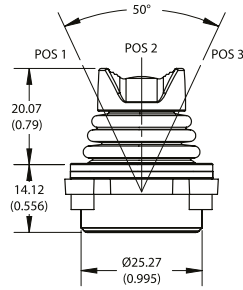
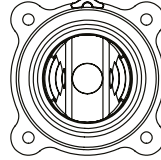

HANDLE OPTIONS

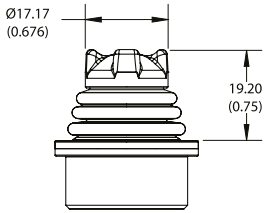

1 Castle

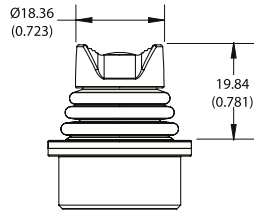

2 Winged hat

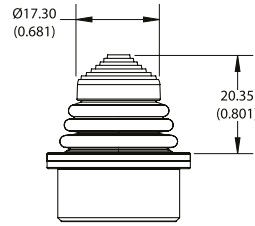

3 Conical